



# THE DATASHEET OF NTB4302



# ON Semiconductor

## Is Now

# onsemi™

To learn more about onsemi™, please visit our website at  
[www.onsemi.com](http://www.onsemi.com)

---

**onsemi** and **onsemi** and other names, marks, and brands are registered and/or common law trademarks of Semiconductor Components Industries, LLC dba "**onsemi**" or its affiliates and/or subsidiaries in the United States and/or other countries. **onsemi** owns the rights to a number of patents, trademarks, copyrights, trade secrets, and other intellectual property. A listing of **onsemi** product/patent coverage may be accessed at [www.onsemi.com/site/pdf/Patent-Marking.pdf](http://www.onsemi.com/site/pdf/Patent-Marking.pdf). **onsemi** reserves the right to make changes at any time to any products or information herein, without notice. The information herein is provided "as-is" and **onsemi** makes no warranty, representation or guarantee regarding the accuracy of the information, product features, availability, functionality, or suitability of its products for any particular purpose, nor does **onsemi** assume any liability arising out of the application or use of any product or circuit, and specifically disclaims any and all liability, including without limitation special, consequential or incidental damages. Buyer is responsible for its products and applications using **onsemi** products, including compliance with all laws, regulations and safety requirements or standards, regardless of any support or applications information provided by **onsemi**. "Typical" parameters which may be provided in **onsemi** data sheets and/or specifications can and do vary in different applications and actual performance may vary over time. All operating parameters, including "Typicals" must be validated for each customer application by customer's technical experts. **onsemi** does not convey any license under any of its intellectual property rights nor the rights of others. **onsemi** products are not designed, intended, or authorized for use as a critical component in life support systems or any FDA Class 3 medical devices or medical devices with a same or similar classification in a foreign jurisdiction or any devices intended for implantation in the human body. Should Buyer purchase or use **onsemi** products for any such unintended or unauthorized application, Buyer shall indemnify and hold **onsemi** and its officers, employees, subsidiaries, affiliates, and distributors harmless against all claims, costs, damages, and expenses, and reasonable attorney fees arising out of, directly or indirectly, any claim of personal injury or death associated with such unintended or unauthorized use, even if such claim alleges that **onsemi** was negligent regarding the design or manufacture of the part. **onsemi** is an Equal Opportunity/Affirmative Action Employer. This literature is subject to all applicable copyright laws and is not for resale in any manner. Other names and brands may be claimed as the property of others.

# NTP4302, NTB4302

## Power MOSFET 74 Amps, 30 Volts

### N-Channel TO-220 & D<sup>2</sup>PAK

#### Features

- Low  $R_{DS(on)}$
- Higher Efficiency Extending Battery Life
- Diode Exhibits High Speed, Soft Recovery
- Avalanche Energy Specified
- $I_{DSS}$  Specified at Elevated Temperature
- Pb-Free Packages are Available

#### Typical Applications

- DC-DC Converters
- Low Voltage Motor Control
- Power Management in Portable and Battery Powered Products:  
Ie: Computers, Printers, Cellular and Cordless Telephones, and PCMCIA Cards

#### MAXIMUM RATINGS ( $T_J = 25^\circ\text{C}$ unless otherwise noted)

| Rating   | Symbol                             | Value          | Unit                     |
|--|------------------------------------|----------------|--------------------------|
| Drain-to-Source Voltage  | $V_{DSS}$                          | 30             | Vdc                      |
| Drain-to-Gate Voltage ( $R_{GS} = 10\text{ M}\Omega$ )   | $V_{DGR}$                          | 30             | Vdc                      |
| Gate-to-Source Voltage – Continuous  | $V_{GS}$                           | $\pm 20$       | Vdc                      |
| Drain Current  | $I_D$                              | 74             | Adc                      |
| – Continuous @ $T_C = 25^\circ\text{C}$  | $I_D$                              | 47             |                          |
| – Continuous @ $T_C = 100^\circ\text{C}$   | $I_{DM}$                           | 175            | Apk                      |
| – Single Pulse ( $t_p \leq 10\ \mu\text{s}$ )  |                                    |                |                          |
| Total Power Dissipation @ $T_C = 25^\circ\text{C}$<br>Derate above $25^\circ\text{C}$  | $P_D$                              | 80<br>0.66     | W<br>W/ $^\circ\text{C}$ |
| Operating and Storage Temperature Range  | $T_J, T_{stg}$                     | -55 to<br>+150 | $^\circ\text{C}$         |
| Single Pulse Drain-to-Source Avalanche<br>Energy – Starting $T_J = 25^\circ\text{C}$<br>( $V_{DD} = 30\text{ Vdc}$ , $V_{GS} = 10\text{ Vdc}$ , $L = 5.0\text{ mH}$<br>$I_{L(pk)} = 17\text{ A}$ , $V_{DS} = 30\text{ Vdc}$ , $R_G = 25\ \Omega$ ) | $E_{AS}$                           | 722            | mJ                       |
| Thermal Resistance   | $R_{\theta JC}$<br>$R_{\theta JA}$ | 1.55<br>70     | $^\circ\text{C/W}$       |
| – Junction-to-Case   |                                    |                |                          |
| – Junction-to-Ambient (Note 1)   |                                    |                |                          |
| Maximum Lead Temperature for Soldering<br>Purposes, 1/8 in from case for 10 seconds  | $T_L$                              | 260            | $^\circ\text{C}$         |

Maximum ratings are those values beyond which device damage can occur. Maximum ratings applied to the device are individual stress limit values (not normal operating conditions) and are not valid simultaneously. If these limits are exceeded, device functional operation is not implied, damage may occur and reliability may be affected.

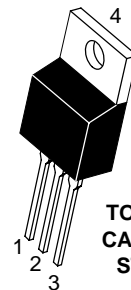
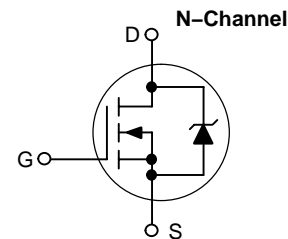
1. When surface mounted to an FR4 Board using minimum recommended Pad Size, (Cu Area 0.412 in<sup>2</sup>).
2. Current limited by internal lead wires.



ON Semiconductor®

<http://onsemi.com>

| $V_{DSS}$ | $R_{DS(ON)}\text{ MAX}$ | $I_D\text{ MAX}$ |
|-----------|-------------------------|------------------|
| 30 V      | 9.3 m $\Omega$ @ 10 V   | 74 A             |

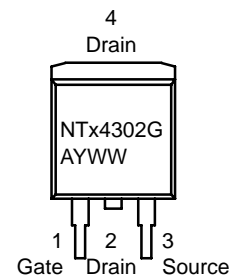
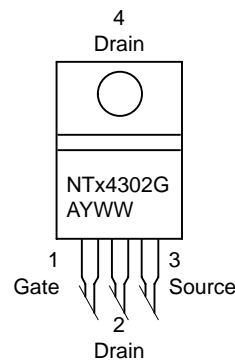


TO-220AB  
CASE 221A  
STYLE 5



D<sup>2</sup>PAK  
CASE 418AA  
STYLE 2

#### MARKING DIAGRAMS & PIN ASSIGNMENTS



NTx4302 = Device Code  
x = B or P  
A = Assembly Location  
Y = Year  
WW = Work Week  
G = Pb-Free Package

#### ORDERING INFORMATION

See detailed ordering and shipping information in the package dimensions section on page 5 of this data sheet.

# NTP4302, NTB4302

## ELECTRICAL CHARACTERISTICS (T<sub>J</sub> = 25°C unless otherwise noted)

| Characteristic | Symbol | Min | Typ | Max | Unit |
|----------------|--------|-----|-----|-----|------|
|----------------|--------|-----|-----|-----|------|

### OFF CHARACTERISTICS

|   |                      |         |         |           |              |
|---|----------------------|---------|---------|-----------|--------------|
| Drain-to-Source Breakdown Voltage (Note 3)<br>(V <sub>GS</sub> = 0 Vdc, I <sub>D</sub> = 250 μAdc)<br>Temperature Coefficient (Positive)                              | V <sub>(BR)DSS</sub> | 30<br>– | –<br>25 | –<br>–    | Vdc<br>mV/°C |
| Zero Gate Voltage Drain Current<br>(V <sub>DS</sub> = 30 Vdc, V <sub>GS</sub> = 0 Vdc)<br>(V <sub>DS</sub> = 30 Vdc, V <sub>GS</sub> = 0 Vdc, T <sub>J</sub> = 125°C) | I <sub>DSS</sub>     | –<br>–  | –<br>–  | 1.0<br>10 | μAdc         |
| Gate-Body Leakage Current (V <sub>GS</sub> = ±20 Vdc, V <sub>DS</sub> = 0 Vdc)  | I <sub>GSS</sub>     | –       | –       | ±100      | nAdc         |

### ON CHARACTERISTICS (Note 3)

|   |                     |          |                   |                    |              |
|---|---------------------|----------|-------------------|--------------------|--------------|
| Gate Threshold Voltage (Note 3)<br>(V <sub>DS</sub> = V <sub>GS</sub> , I <sub>D</sub> = 250 μAdc)<br>Threshold Temperature Coefficient (Negative)  | V <sub>GS(th)</sub> | 1.0<br>– | 1.9<br>–3.8       | 3.0<br>–           | Vdc<br>mV/°C |
| Static Drain-to-Source On-Resistance (Note 3)<br>(V <sub>GS</sub> = 10 Vdc, I <sub>D</sub> = 37 Adc)<br>(V <sub>GS</sub> = 10 Vdc, I <sub>D</sub> = 20 Adc)<br>(V <sub>GS</sub> = 4.5 Vdc, I <sub>D</sub> = 10 Adc) | R <sub>DS(on)</sub> | –        | 6.8<br>6.8<br>9.5 | 9.3<br>9.3<br>12.5 | mΩ           |
| Forward Transconductance (Note 3) (V <sub>DS</sub> = 10 Vdc, I <sub>D</sub> = 20 Adc)   | g <sub>FS</sub>     | –        | 40                | –                  | mhos         |

### DYNAMIC CHARACTERISTICS

|                      |   |                  |   |      |      |    |
|----------------------|---|------------------|---|------|------|----|
| Input Capacitance    | (V <sub>DS</sub> = 24 Vdc, V <sub>GS</sub> = 0 Vdc,<br>f = 1.0 MHz) | C <sub>iss</sub> | – | 2050 | 2400 | pF |
| Output Capacitance   |   | C <sub>oss</sub> | – | 640  | 800  |    |
| Transfer Capacitance |   | C <sub>rss</sub> | – | 225  | 310  |    |

### SWITCHING CHARACTERISTICS (Note 4)

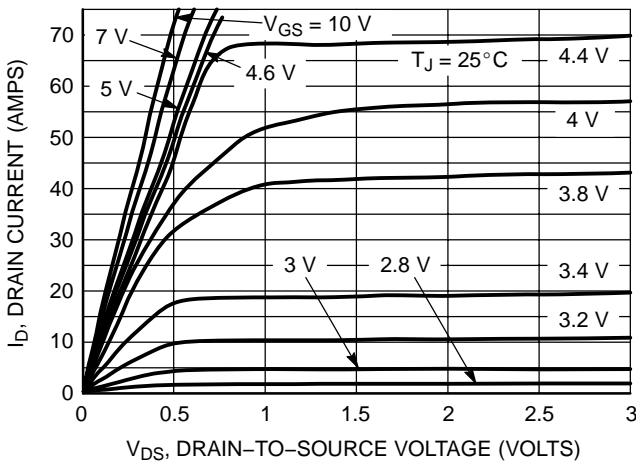
|                     |  |                     |   |     |    |    |
|---------------------|--|---------------------|---|-----|----|----|
| Turn-On Delay Time  | (V <sub>DD</sub> = 24 Vdc, I <sub>D</sub> = 20 Adc,<br>V <sub>GS</sub> = 10 Vdc, R <sub>G</sub> = 2.5 Ω) (Note 3)  | t <sub>d(on)</sub>  | – | 10  | 18 | ns |
| Rise Time           |  | t <sub>r</sub>      | – | 22  | 35 |    |
| Turn-Off Delay Time |  | t <sub>d(off)</sub> | – | 45  | 75 |    |
| Fall Time           |  | t <sub>f</sub>      | – | 35  | 70 |    |
| Turn-On Delay Time  | (V <sub>DD</sub> = 24 Vdc, I <sub>D</sub> = 10 Adc,<br>V <sub>GS</sub> = 4.5 Vdc, R <sub>G</sub> = 2.5 Ω) (Note 3) | t <sub>d(on)</sub>  | – | 18  | –  | ns |
| Rise Time           |  | t <sub>r</sub>      | – | 70  | –  |    |
| Turn-Off Delay Time |  | t <sub>d(off)</sub> | – | 32  | –  |    |
| Fall Time           |  | t <sub>f</sub>      | – | 30  | –  |    |
| Gate Charge         | (V <sub>DS</sub> = 24 Vdc, I <sub>D</sub> = 37 Adc,<br>V <sub>GS</sub> = 4.5 Vdc) (Note 3)                         | Q <sub>T</sub>      | – | 28  | –  | nC |
|                     |  | Q <sub>gs</sub>     | – | 7.5 | –  |    |
|                     |  | Q <sub>gd</sub>     | – | 19  | –  |    |

### SOURCE-DRAIN DIODE CHARACTERISTICS

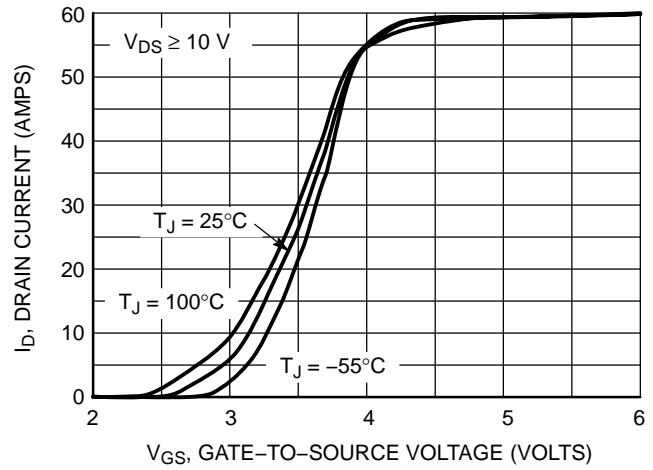
|                                |   |                 |        |              |          |     |
|--------------------------------|---|-----------------|--------|--------------|----------|-----|
| Forward On-Voltage             | (I <sub>S</sub> = 20 Adc, V <sub>GS</sub> = 0 Vdc) (Note 3)<br>(I <sub>S</sub> = 20 Adc, V <sub>GS</sub> = 0 Vdc, T <sub>J</sub> = 125°C) | V <sub>SD</sub> | –<br>– | 0.90<br>0.75 | 1.3<br>– | Vdc |
| Reverse Recovery Time          | (I <sub>S</sub> = 20 Adc, V <sub>GS</sub> = 0 Vdc,<br>di <sub>S</sub> /dt = 100 A/μs) (Note 3)  | t <sub>rr</sub> | –      | 37           | –        | ns  |
|                                |   | t <sub>a</sub>  | –      | 21           | –        |     |
|                                |   | t <sub>b</sub>  | –      | 16           | –        |     |
| Reverse Recovery Stored Charge |   | Q <sub>RR</sub> | –      | 0.035        | –        | μC  |

3. Pulse Test: Pulse Width ≤ 300 μs, Duty Cycle ≤ 2%.
4. Switching characteristics are independent of operating junction temperatures.

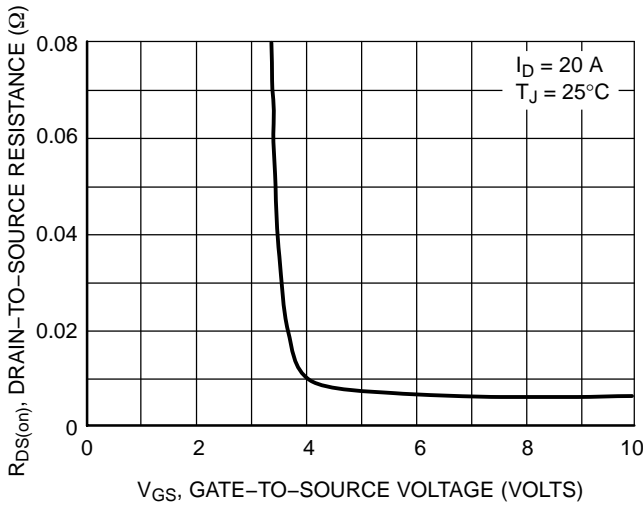
# NTP4302, NTB4302



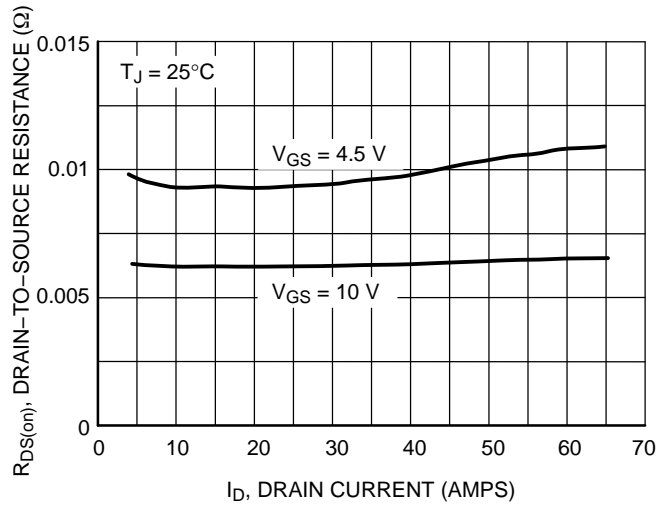
**Figure 1. On-Region Characteristics**



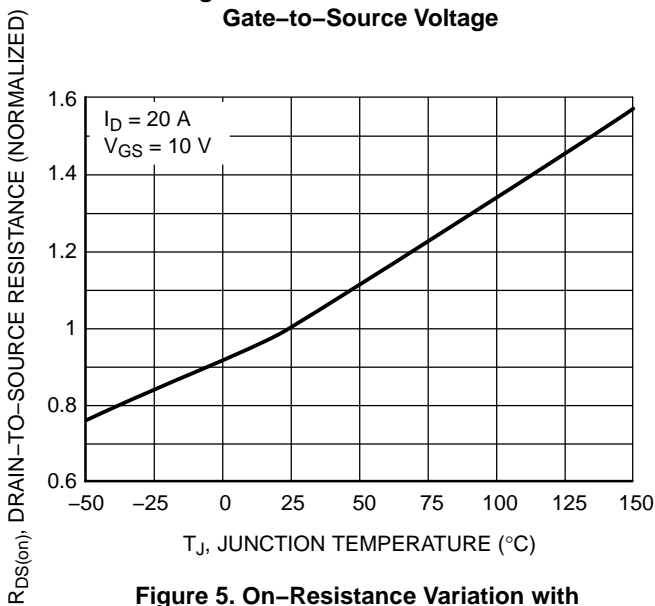
**Figure 2. Transfer Characteristics**



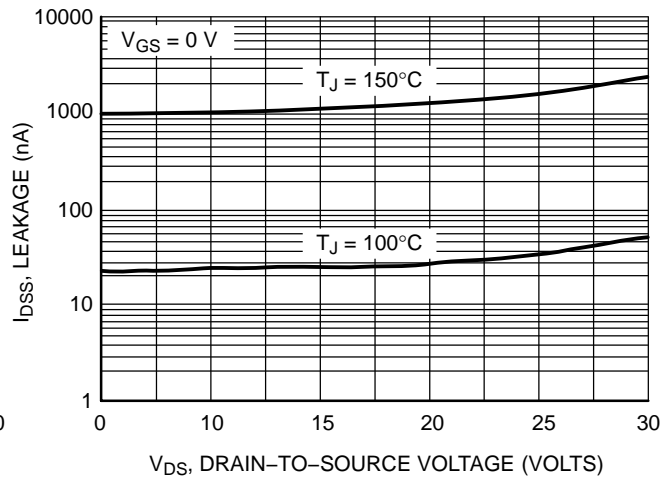
**Figure 3. On-Resistance versus Gate-to-Source Voltage**



**Figure 4. On-Resistance versus Drain Current and Gate Voltage**

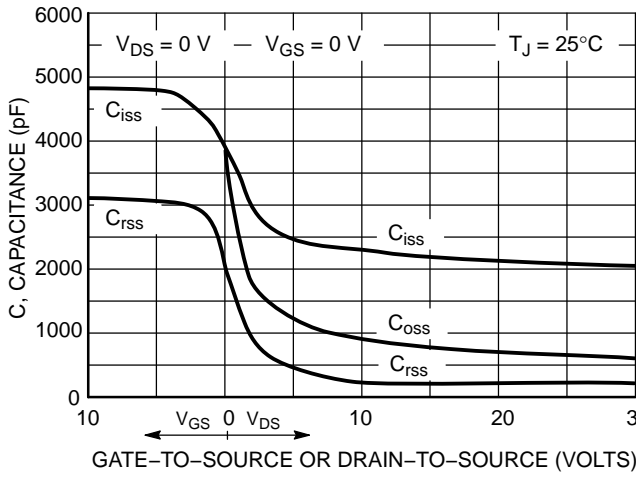


**Figure 5. On-Resistance Variation with Temperature**

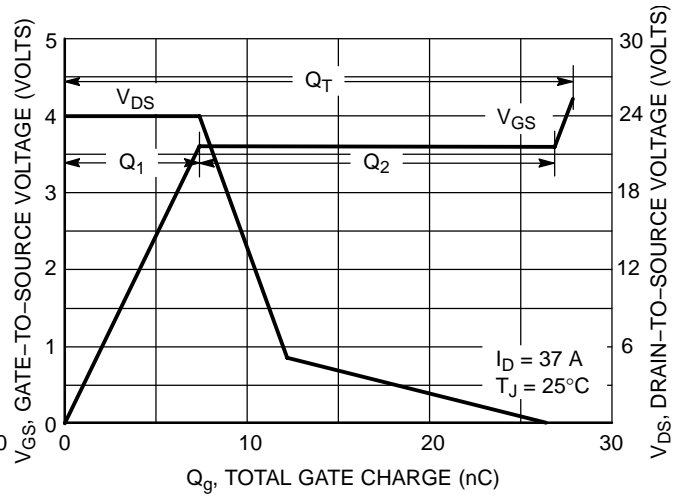


**Figure 6. Drain-to-Source Leakage Current versus Voltage**

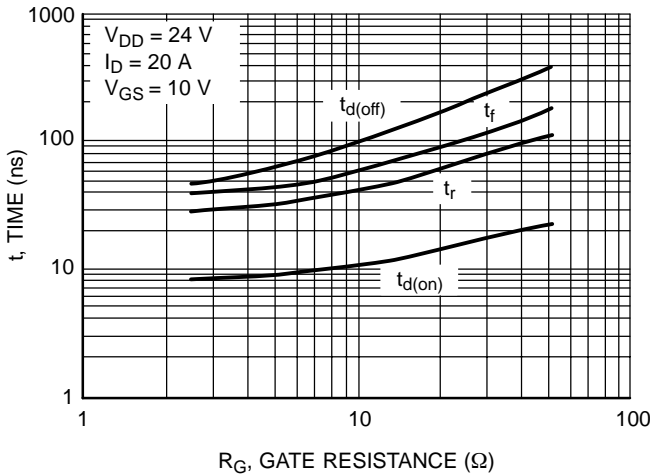
# NTP4302, NTB4302



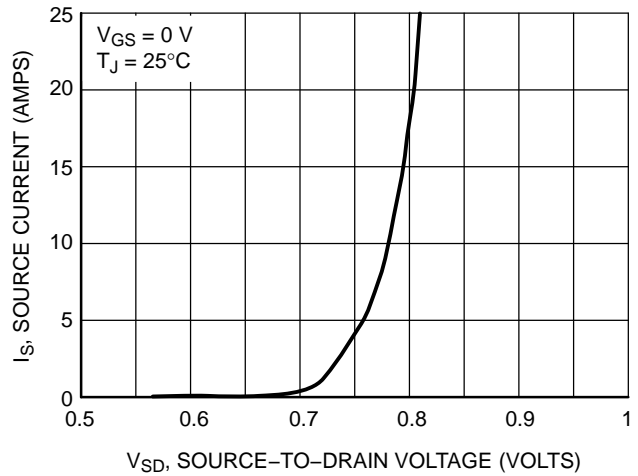
**Figure 7. Capacitance Variation**



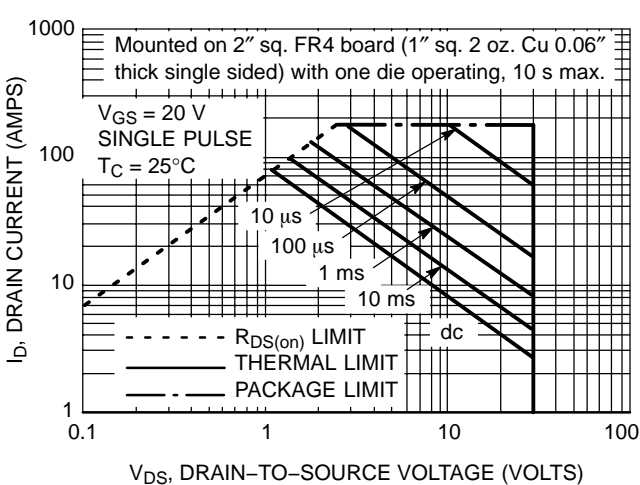
**Figure 8. Gate-to-Source and Drain-to-Source Voltage versus Total Charge**



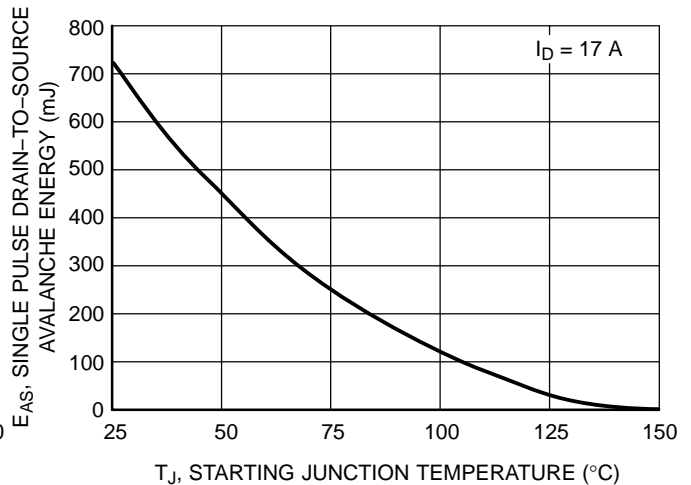
**Figure 9. Resistive Switching Time Variations versus Gate Resistance**



**Figure 10. Diode Forward Voltage versus Current**



**Figure 11. Maximum Rated Forward Biased Safe Operating Area**



**Figure 12. Maximum Avalanche Energy versus Starting Junction Temperature**

# NTP4302, NTB4302

## SAFE OPERATING AREA

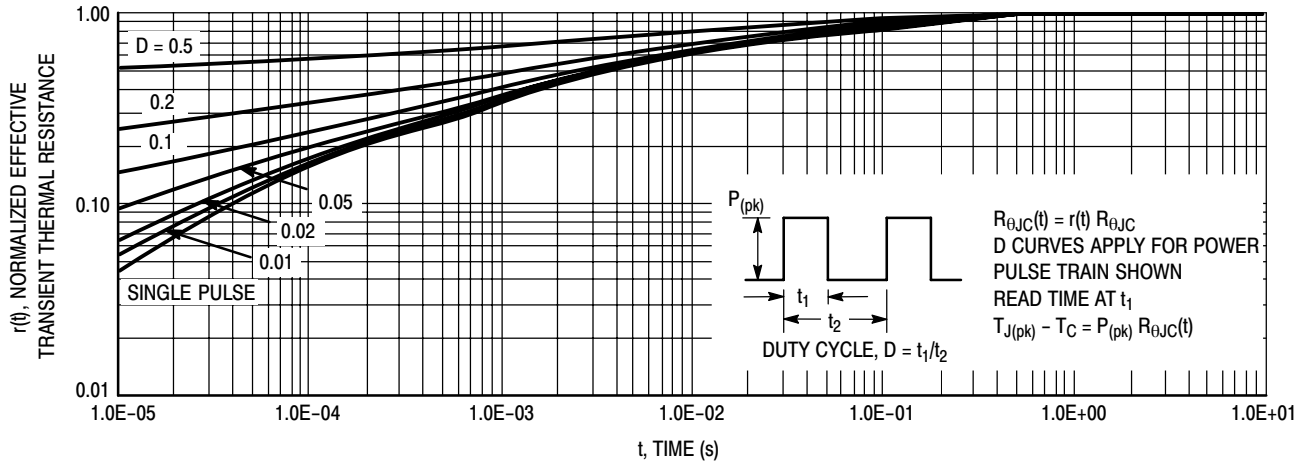


Figure 13. Thermal Response

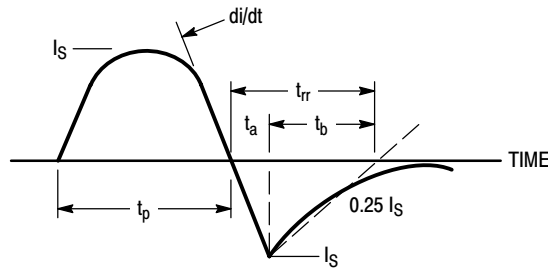


Figure 14. Diode Reverse Recovery Waveform

### ORDERING INFORMATION

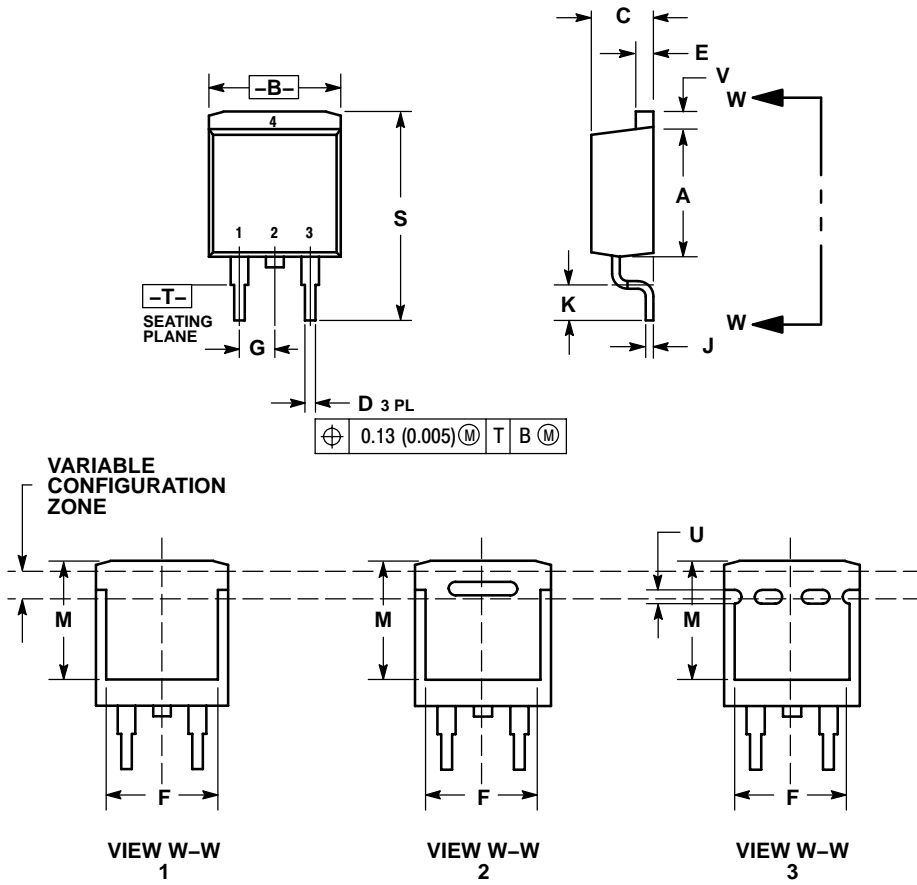
| Device     | Package                         | Shipping <sup>†</sup> |
|------------|---------------------------------|-----------------------|
| NTP4302    | TO-220AB                        | 50 Units / Rail       |
| NTP4302G   | TO-220AB<br>(Pb-Free)           | 50 Units / Rail       |
| NTB4302    | D <sup>2</sup> PAK              | 50 Units / Rail       |
| NTB4302G   | D <sup>2</sup> PAK<br>(Pb-Free) | 50 Units / Rail       |
| NTB4302T4  | D <sup>2</sup> PAK              | 800 / Tape & Reel     |
| NTB4302T4G | D <sup>2</sup> PAK<br>(Pb-Free) | 800 / Tape & Reel     |

<sup>†</sup>For information on tape and reel specifications, including part orientation and tape sizes, please refer to our Tape and Reel Packaging Specifications Brochure, BRD8011/D.

# NTP4302, NTB4302

## PACKAGE DIMENSIONS

**D<sup>2</sup>PAK**  
CASE 418AA-01  
ISSUE O

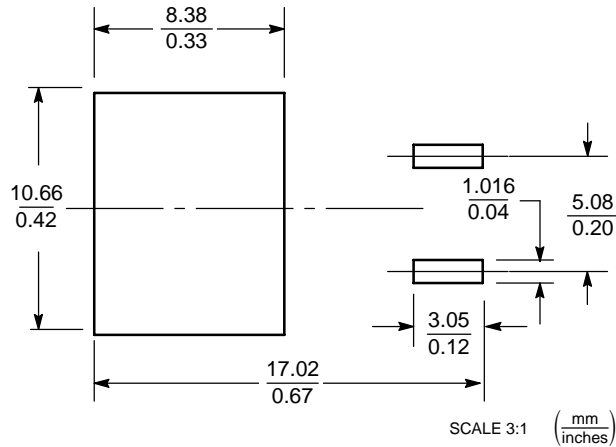


- NOTES:  
1. DIMENSIONING AND TOLERANCING PER ANSI Y14.5M, 1982.  
2. CONTROLLING DIMENSION: INCH.

| DIM | INCHES |       | MILLIMETERS |       |
|-----|--------|-------|-------------|-------|
|     | MIN    | MAX   | MIN         | MAX   |
| A   | 0.340  | 0.380 | 8.64        | 9.65  |
| B   | 0.380  | 0.405 | 9.65        | 10.29 |
| C   | 0.160  | 0.190 | 4.06        | 4.83  |
| D   | 0.020  | 0.036 | 0.51        | 0.92  |
| E   | 0.045  | 0.055 | 1.14        | 1.40  |
| F   | 0.310  | ---   | 7.87        | ---   |
| G   | 0.100  | BSC   | 2.54        | BSC   |
| J   | 0.018  | 0.025 | 0.46        | 0.64  |
| K   | 0.090  | 0.110 | 2.29        | 2.79  |
| M   | 0.280  | ---   | 7.11        | ---   |
| S   | 0.575  | 0.625 | 14.60       | 15.88 |
| V   | 0.045  | 0.055 | 1.14        | 1.40  |

- STYLE 2:  
PIN 1. GATE  
2. DRAIN  
3. SOURCE  
4. DRAIN

### SOLDERING FOOTPRINT\*

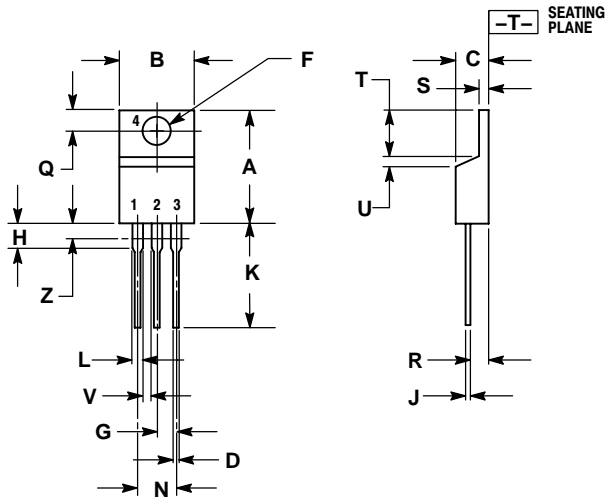


\*For additional information on our Pb-Free strategy and soldering details, please download the ON Semiconductor Soldering and Mounting Techniques Reference Manual, SOLDERRM/D.

# NTP4302, NTB4302

## PACKAGE DIMENSIONS

TO-220  
CASE 221A-09  
ISSUE AA



NOTES:

1. DIMENSIONING AND TOLERANCING PER ANSI Y14.5M, 1982.
2. CONTROLLING DIMENSION: INCH.
3. DIMENSION Z DEFINES A ZONE WHERE ALL BODY AND LEAD IRREGULARITIES ARE ALLOWED.

| DIM | INCHES |       | MILLIMETERS |       |
|-----|--------|-------|-------------|-------|
|     | MIN    | MAX   | MIN         | MAX   |
| A   | 0.570  | 0.620 | 14.48       | 15.75 |
| B   | 0.380  | 0.405 | 9.66        | 10.28 |
| C   | 0.160  | 0.190 | 4.07        | 4.82  |
| D   | 0.025  | 0.035 | 0.64        | 0.88  |
| F   | 0.142  | 0.147 | 3.61        | 3.73  |
| G   | 0.095  | 0.105 | 2.42        | 2.66  |
| H   | 0.110  | 0.155 | 2.80        | 3.93  |
| J   | 0.018  | 0.025 | 0.46        | 0.64  |
| K   | 0.500  | 0.562 | 12.70       | 14.27 |
| L   | 0.045  | 0.060 | 1.15        | 1.52  |
| N   | 0.190  | 0.210 | 4.83        | 5.33  |
| Q   | 0.100  | 0.120 | 2.54        | 3.04  |
| R   | 0.080  | 0.110 | 2.04        | 2.79  |
| S   | 0.045  | 0.055 | 1.15        | 1.39  |
| T   | 0.235  | 0.255 | 5.97        | 6.47  |
| U   | 0.000  | 0.050 | 0.00        | 1.27  |
| V   | 0.045  | ---   | 1.15        | ---   |
| Z   | ---    | 0.080 | ---         | 2.04  |

STYLE 5:

- PIN 1. GATE
2. DRAIN
3. SOURCE
4. DRAIN

ON Semiconductor and are registered trademarks of Semiconductor Components Industries, LLC (SCILLC). SCILLC reserves the right to make changes without further notice to any products herein. SCILLC makes no warranty, representation or guarantee regarding the suitability of its products for any particular purpose, nor does SCILLC assume any liability arising out of the application or use of any product or circuit, and specifically disclaims any and all liability, including without limitation special, consequential or incidental damages. "Typical" parameters which may be provided in SCILLC data sheets and/or specifications can and do vary in different applications and actual performance may vary over time. All operating parameters, including "Typicals" must be validated for each customer application by customer's technical experts. SCILLC does not convey any license under its patent rights nor the rights of others. SCILLC products are not designed, intended, or authorized for use as components in systems intended for surgical implant into the body, or other applications intended to support or sustain life, or for any other application in which the failure of the SCILLC product could create a situation where personal injury or death may occur. Should Buyer purchase or use SCILLC products for any such unintended or unauthorized application, Buyer shall indemnify and hold SCILLC and its officers, employees, subsidiaries, affiliates, and distributors harmless against all claims, costs, damages, and expenses, and reasonable attorney fees arising out of, directly or indirectly, any claim of personal injury or death associated with such unintended or unauthorized use, even if such claim alleges that SCILLC was negligent regarding the design or manufacture of the part. SCILLC is an Equal Opportunity/Affirmative Action Employer. This literature is subject to all applicable copyright laws and is not for resale in any manner.

### PUBLICATION ORDERING INFORMATION

**LITERATURE FULFILLMENT:**  
Literature Distribution Center for ON Semiconductor  
P.O. Box 61312, Phoenix, Arizona 85082-1312 USA  
**Phone:** 480-829-7710 or 800-344-3860 Toll Free USA/Canada  
**Fax:** 480-829-7709 or 800-344-3867 Toll Free USA/Canada  
**Email:** orderlit@onsemi.com

**N. American Technical Support:** 800-282-9855 Toll Free USA/Canada

**Japan:** ON Semiconductor, Japan Customer Focus Center  
2-9-1 Kamimeguro, Meguro-ku, Tokyo, Japan 153-0051  
**Phone:** 81-3-5773-3850



**ON Semiconductor Website:** <http://onsemi.com>

**Order Literature:** <http://www.onsemi.com/litorder>

For additional information, please contact your local Sales Representative.

## Looking for pricing, stock, or lifecycle information?

Click below to explore more details on WIN SOURCE:

-  [View NTB4302 on WIN SOURCE](#)
-  [ON Semiconductor Information](#)

## Optimize Your Supply Chain with WIN SOURCE Solutions

-  Global Sourcing Solution
-  Obsolete Management
-  Cost Control Management
-  Shortage Management
-  Alternative Solution
-  Excess Inventory Management