



**THE DATASHEET OF
NTCLE203E3104FB0**



NTC Thermistors, Radial Leaded, Accuracy Line



LINKS TO ADDITIONAL RESOURCES



QUICK REFERENCE DATA		
PARAMETER	VALUE	UNIT
Resistance value at 25 °C	2K to 470K	Ω
Tolerance on R_{25} -value	± 1; ± 2; ± 3; ± 5	%
$B_{25/85}$ -value	3528 to 4570	K
Tolerance on $B_{25/85}$ -value	± 0.5 to ± 2.0	%
Operating temperature range at: Zero power dissipation (continuously) Zero power dissipation (for short periods) ⁽²⁾	-40 to +125 ≤ 150	°C
Maximum power dissipation at 55 °C	100	mW
Dissipation factor δ in still air (for info)	2.2	mW/K
Response time ⁽¹⁾	≈ 1.7	s
Thermal time constant τ ⁽¹⁾	13	
Mass	≈ 0.11	g

Notes

- Response time in silicone oil MS200/50. This is the time needed for the sensor to reach 63.2 % of the total temperature difference when subjected to a temperature change from 25 °C in air to 85 °C in oil. Thermal time constant by cooling from electrically pre-heated body
- Valid for all types with the exception of the R_{25} values 12 kΩ, 22 kΩ and 470 kΩ

FEATURES

- Accurate over a wide temperature range (tolerance on B-value down to 0.5 %)
- Good stability over a long life
- Excellent price/performance ratio
- Low heat conductivity through 0.4 mm Ni-leads
- cULus recognized, file E148885 (UL category XGPU2/XGPU8)
- Mounting: radial
- Material categorization: for definitions of compliance please see www.vishay.com/doc?99912

RoHS
COMPLIANT

APPLICATIONS

- Temperature measurement, sensing and control in industrial, consumer, and telecom applications. For on-board sensing or accurate remote sensing

DESCRIPTION

These thermistors are made of NTC ceramic material. The device consists of a chip with two tinned nickel leads. The parts are coated and color marked.

PACKAGING

The thermistors are packed in cardboard boxes; the smallest packing quantity is 500 units.

DESIGN-IN SUPPORT

For complete curve computation, please visit:
www.vishay.com/en/thermistors/ntc-rt-calculator/.

MARKING

The thermistors are marked with colored dots on a gray epoxy base coating; see Dimensions and “Electrical Data and Ordering Information”.

CAUTIONS AND WARNINGS ON MOUNTING AND HANDLING

Please read the special instructions:
see www.vishay.com/doc?29222.
By soldering in any position. Not intended for potting.

ELECTRICAL DATA AND ORDERING INFORMATION							
R_{25} (Ω)	R_{25} -TOL. (± %)	$B_{25/85}$ (K)	$B_{25/85}$ -TOL. (± %)	COLOR MARKING	UL RECOG. 	SAP MATERIAL AND ORDERING NUMBER ⁽¹⁾	
						RoHS-COMPLIANT WITH EXEMPTION ⁽²⁾	RoHS-COMPLIANT
2000	1, 2, 3, 5	3528	0.5	Orange	✓	NTCLE203E3202*B0	NTCLE203E3202*B0A
2700	1, 2, 3, 5	3977	0.75	Red	✓	NTCLE203E3272*B0	NTCLE203E3272*B0A
4700	1, 2, 3, 5	3977	0.75	Green	✓	NTCLE203E3472*B0	NTCLE203E3472*B0A
5000	1, 2, 3, 5	3977	0.75	Pink	✓	NTCLE203E3502*B0	NTCLE203E3502*B0A
10 000	1, 2, 3, 5	3977	0.75	Blue	✓	NTCLE203E3103*B0	NTCLE203E3103*B0A
12 000	1, 2, 3, 5	3740	2	Yellow	✓	NTCLE203E3123*B0	NTCLE203E3123*B0A
22 000	1, 2, 3, 5	3740	2	White	✓	NTCLE203E3223*B0	NTCLE203E3223*B0A
47 000	1, 2, 3, 5	4090	1.5	Black	✓	NTCLE203E3473*B0	NTCLE203E3473*B0A
68 000	1, 2, 3, 5	4190	1.5	Grey	✓	NTCLE203E3683*B0	NTCLE203E3683*B0A
100 000	1, 2, 3, 5	4190	1.5	Brown	✓	NTCLE203E3104*B0	NTCLE203E3104*B0A
470 000	2, 3, 5	4570	1.5	Violet	✓	NTCLE203E3474*B0	NTCLE203E3474*B0A

Notes

- Preferred versions for new designs
- Replace * in SAP by J for ± 5 %, H for ± 3 %, G for ± 2 %, F for ± 1 %
- RoHS exemption 7(c)-I: electrical and electronic components containing lead in a glass or ceramic other than dielectric ceramic in capacitors, e.g. piezo-electronic devices, or in a glass or ceramic matrix compound

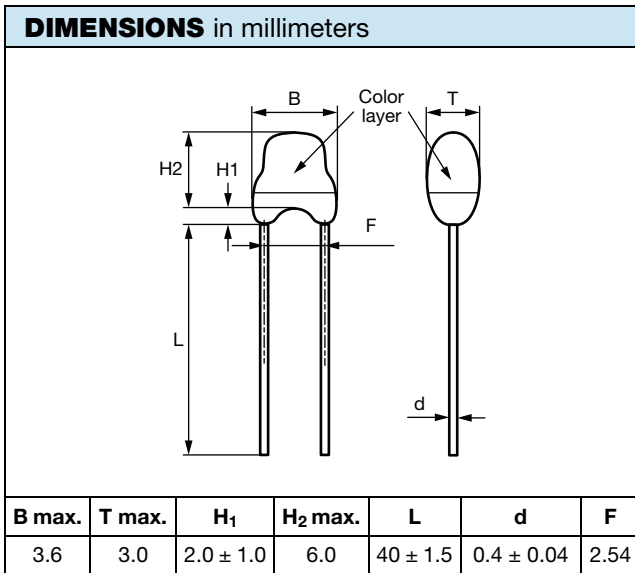

DERATING

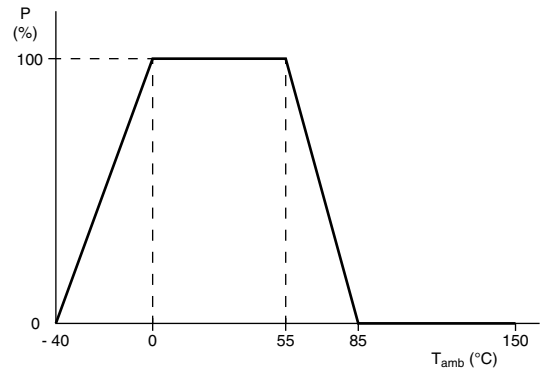

Power derating curve

Note

- Zero power is considered as measuring power max. 1 % of max. power

LONG TERM STABILITY AS A FUNCTION OF TEST DURATION AT MAXIMUM TEMPERATURE (150 °C)

TYPICAL R₂₅ STABILITY

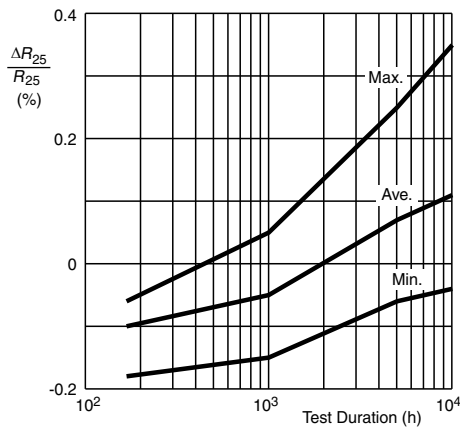

Typical curves valid for 2.2 kΩ to 10 kΩ

TYPICAL ROOM TEMPERATURE STABILITY

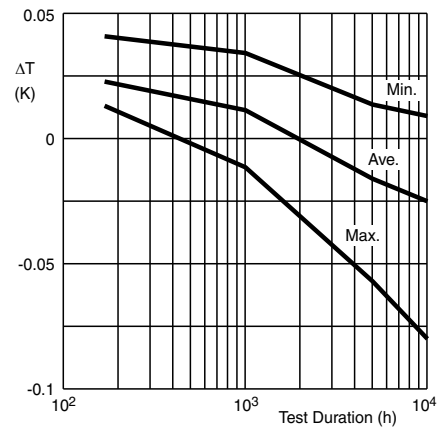

Typical curves valid for 2.2 kΩ to 10 kΩ



Disclaimer

ALL PRODUCT, PRODUCT SPECIFICATIONS AND DATA ARE SUBJECT TO CHANGE WITHOUT NOTICE TO IMPROVE RELIABILITY, FUNCTION OR DESIGN OR OTHERWISE.

Vishay Intertechnology, Inc., its affiliates, agents, and employees, and all persons acting on its or their behalf (collectively, "Vishay"), disclaim any and all liability for any errors, inaccuracies or incompleteness contained in any datasheet or in any other disclosure relating to any product.

Vishay makes no warranty, representation or guarantee regarding the suitability of the products for any particular purpose or the continuing production of any product. To the maximum extent permitted by applicable law, Vishay disclaims (i) any and all liability arising out of the application or use of any product, (ii) any and all liability, including without limitation special, consequential or incidental damages, and (iii) any and all implied warranties, including warranties of fitness for particular purpose, non-infringement and merchantability.

Statements regarding the suitability of products for certain types of applications are based on Vishay's knowledge of typical requirements that are often placed on Vishay products in generic applications. Such statements are not binding statements about the suitability of products for a particular application. It is the customer's responsibility to validate that a particular product with the properties described in the product specification is suitable for use in a particular application. Parameters provided in datasheets and / or specifications may vary in different applications and performance may vary over time. All operating parameters, including typical parameters, must be validated for each customer application by the customer's technical experts. Product specifications do not expand or otherwise modify Vishay's terms and conditions of purchase, including but not limited to the warranty expressed therein.

Hyperlinks included in this datasheet may direct users to third-party websites. These links are provided as a convenience and for informational purposes only. Inclusion of these hyperlinks does not constitute an endorsement or an approval by Vishay of any of the products, services or opinions of the corporation, organization or individual associated with the third-party website. Vishay disclaims any and all liability and bears no responsibility for the accuracy, legality or content of the third-party website or for that of subsequent links.

Except as expressly indicated in writing, Vishay products are not designed for use in medical, life-saving, or life-sustaining applications or for any other application in which the failure of the Vishay product could result in personal injury or death. Customers using or selling Vishay products not expressly indicated for use in such applications do so at their own risk. Please contact authorized Vishay personnel to obtain written terms and conditions regarding products designed for such applications.

No license, express or implied, by estoppel or otherwise, to any intellectual property rights is granted by this document or by any conduct of Vishay. Product names and markings noted herein may be trademarks of their respective owners.

Looking for pricing, stock, or lifecycle information?

Click below to explore more details on WIN SOURCE:

 [View NTCLE203E3104FB0 on WIN SOURCE](#)

 [Vishay Information](#)

Optimize Your Supply Chain with WIN SOURCE Solutions

-  Global Sourcing Solution
-  Obsolete Management
-  Cost Control Management
-  Shortage Management
-  Alternative Solution
-  Excess Inventory Management