



# MOSFET – Power, N-Channel

## 100 V, 17 A, 81 mΩ

### NTD6416AN, NVD6416AN

#### Features

- Low  $R_{DS(on)}$
- High Current Capability
- 100% Avalanche Tested
- HBM ESD Level Class 1B, MM ESD Level Class M2
- NVD Prefix for Automotive and Other Applications Requiring Unique Site and Control Change Requirements; AEC-Q101 Qualified and PPAP Capable
- These Devices are Pb-Free and are RoHS Compliant

#### MAXIMUM RATINGS ( $T_J = 25^\circ\text{C}$ unless otherwise noted)

| Parameter   | Symbol                 | Value                     | Unit             |   |
|---|------------------------|---------------------------|------------------|---|
| Drain-to-Source Voltage   | $V_{DSS}$              | 100                       | V                |   |
| Gate-to-Source Voltage – Continuous   | $V_{GS}$               | $\pm 20$                  | V                |   |
| Continuous Drain Current  | Steady State           | $T_C = 25^\circ\text{C}$  | 17               | A |
|   |                        | $T_C = 100^\circ\text{C}$ | 11               |   |
| Power Dissipation   | Steady State           | $T_C = 25^\circ\text{C}$  | 71               | W |
| Pulsed Drain Current  | $t_p = 10 \mu\text{s}$ | $I_{DM}$                  | 62               | A |
| Operating and Storage Temperature Range   | $T_J, T_{stg}$         | -55 to +175               | $^\circ\text{C}$ |   |
| Source Current (Body Diode)   | $I_S$                  | 17                        | A                |   |
| Single Pulse Drain-to-Source Avalanche Energy ( $V_{DD} = 50 \text{ Vdc}$ , $V_{GS} = 10 \text{ Vdc}$ , $I_{L(pk)} = 17 \text{ A}$ , $L = 0.3 \text{ mH}$ , $R_G = 25 \Omega$ ) | $E_{AS}$               | 43                        | mJ               |   |
| Lead Temperature for Soldering Purposes, 1/8" from Case for 10 Seconds  | $T_L$                  | 260                       | $^\circ\text{C}$ |   |

Stresses exceeding those listed in the Maximum Ratings table may damage the device. If any of these limits are exceeded, device functionality should not be assumed, damage may occur and reliability may be affected.

#### THERMAL RESISTANCE RATINGS

| Parameter                             | Symbol          | Max | Unit               |
|---------------------------------------|-----------------|-----|--------------------|
| Junction-to-Case (Drain) Steady State | $R_{\theta JC}$ | 2.1 | $^\circ\text{C/W}$ |
| Junction-to-Ambient (Note 1)          | $R_{\theta JA}$ | 40  |                    |

1. Surface mounted on FR4 board using 1 sq in pad size, (Cu Area 1.127 sq in [2 oz] including traces).

| $V_{(BR)DSS}$ | $R_{DS(on)}$ MAX | $I_D$ MAX (Note 1) |
|---------------|------------------|--------------------|
| 100 V         | 81 mΩ @ 10 V     | 17 A               |

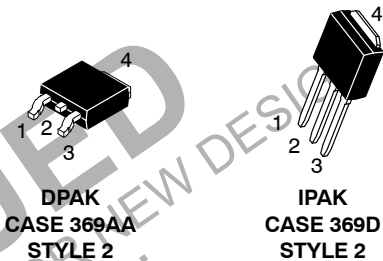
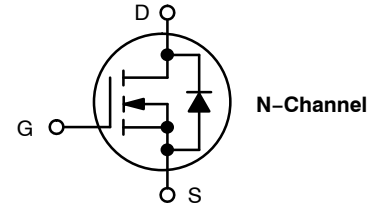

#### MARKING DIAGRAM & PIN ASSIGNMENTS

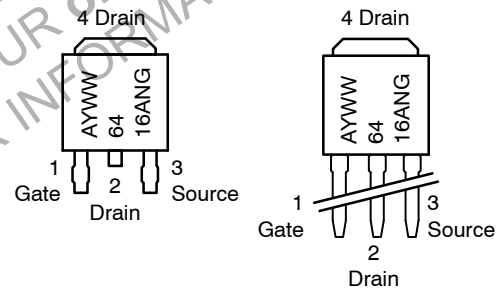

- A = Assembly Location\*
- Y = Year
- WW = Work Week
- 6416AN = Device Code
- G = Pb-Free Package

\* The Assembly Location code (A) is front side optional. In cases where the Assembly Location is stamped in the package, the front side assembly code may be blank.

#### ORDERING INFORMATION

See detailed ordering and shipping information on page 5 of this data sheet.

# NTD6416AN, NVD6416AN

## ELECTRICAL CHARACTERISTICS (T<sub>J</sub> = 25°C unless otherwise noted)

| Parameter   | Symbol                               | Test Condition                                    | Min | Typ | Max  | Unit  |
|---|--------------------------------------|---|-----|-----|------|-------|
| Drain-to-Source Breakdown Voltage                         | V <sub>(BR)DSS</sub>                 | V <sub>GS</sub> = 0 V, I <sub>D</sub> = 250 μA    | 100 |     |      | V     |
| Drain-to-Source Breakdown Voltage Temperature Coefficient | V <sub>(BR)DSS</sub> /T <sub>J</sub> |   |     | 112 |      | mV/°C |
| Zero Gate Voltage Drain Current                           | I <sub>DSS</sub>                     | V <sub>GS</sub> = 0 V,<br>V <sub>DS</sub> = 100 V |     |     | 1.0  | μA    |
|   |                                      |   |     |     | 10   |       |
| Gate-to-Source Leakage Current                            | I <sub>GSS</sub>                     | V <sub>DS</sub> = 0 V, V <sub>GS</sub> = ±20 V    |     |     | ±100 | nA    |

## ON CHARACTERISTICS (Note 3)

|  |                                     |   |     |     |     |       |
|--|-------------------------------------|---|-----|-----|-----|-------|
| Gate Threshold Voltage                     | V <sub>GS(TH)</sub>                 | V <sub>GS</sub> = V <sub>DS</sub> , I <sub>D</sub> = 250 μA | 2.0 |     | 4.0 | V     |
| Negative Threshold Temperature Coefficient | V <sub>GS(TH)</sub> /T <sub>J</sub> |   |     | 7.7 |     | mV/°C |
| Drain-to-Source On-Resistance              | R <sub>DS(on)</sub>                 | V <sub>GS</sub> = 10 V, I <sub>D</sub> = 17 A               |     | 73  | 81  | mΩ    |
| Forward Transconductance                   | g <sub>FS</sub>                     | V <sub>DS</sub> = 5 V, I <sub>D</sub> = 10 A                |     | 12  |     | S     |

## CHARGES, CAPACITANCES AND GATE RESISTANCE

|                              |                     |   |     |  |  |    |   |
|------------------------------|---------------------|---|-----|--|--|----|---|
| Input Capacitance            | C <sub>ISS</sub>    | V <sub>GS</sub> = 0 V, f = 1.0 MHz, V <sub>DS</sub> = 25 V            | 620 |  |  | pF |   |
| Output Capacitance           | C <sub>OSS</sub>    |   | 110 |  |  |    |   |
| Reverse Transfer Capacitance | C <sub>RSS</sub>    |   | 50  |  |  |    |   |
| Total Gate Charge            | Q <sub>G(TOT)</sub> | V <sub>GS</sub> = 10 V, V <sub>DS</sub> = 80 V, I <sub>D</sub> = 17 A | 20  |  |  | nC |   |
| Threshold Gate Charge        | Q <sub>G(TH)</sub>  |   | 1.0 |  |  |    |   |
| Gate-to-Source Charge        | Q <sub>GS</sub>     |   | 3.6 |  |  |    |   |
| Gate-to-Drain Charge         | Q <sub>GD</sub>     |   | 10  |  |  |    |   |
| Plateau Voltage              | V <sub>GP</sub>     |   | 5.8 |  |  |    | V |
| Gate Resistance              | R <sub>G</sub>      |   | 2.4 |  |  |    | Ω |

## SWITCHING CHARACTERISTICS (Note 4)

|                     |                     |  |     |  |  |    |
|---------------------|---------------------|--|-----|--|--|----|
| Turn-On Delay Time  | t <sub>d(on)</sub>  | V <sub>GS</sub> = 10 V, V <sub>DD</sub> = 80 V,<br>I <sub>D</sub> = 17 A, R <sub>G</sub> = 6.1 Ω | 9.2 |  |  | ns |
| Rise Time           | t <sub>r</sub>      |  | 22  |  |  |    |
| Turn-Off Delay Time | t <sub>d(off)</sub> |  | 24  |  |  |    |
| Fall Time           | t <sub>f</sub>      |  | 20  |  |  |    |

## DRAIN-SOURCE DIODE CHARACTERISTICS

|                         |                 |   |                        |      |     |    |
|-------------------------|-----------------|---|------------------------|------|-----|----|
| Forward Diode Voltage   | V <sub>SD</sub> | V <sub>GS</sub> = 0 V, I <sub>S</sub> = 17 A                                    | T <sub>J</sub> = 25°C  | 0.85 | 1.2 | V  |
|                         |                 |   | T <sub>J</sub> = 125°C | 0.7  |     |    |
| Reverse Recovery Time   | t <sub>rr</sub> | V <sub>GS</sub> = 0 V, dI <sub>S</sub> /dt = 100 A/μs,<br>I <sub>S</sub> = 17 A |                        | 56   |     | ns |
| Charge Time             | t <sub>a</sub>  |   |                        | 41   |     |    |
| Discharge Time          | t <sub>b</sub>  |   |                        | 15   |     |    |
| Reverse Recovery Charge | Q <sub>RR</sub> |   |                        | 135  |     |    |

Product parametric performance is indicated in the Electrical Characteristics for the listed test conditions, unless otherwise noted. Product performance may not be indicated by the Electrical Characteristics if operated under different conditions.

- Surface mounted on FR4 board using 1 in sq pad size (Cu area = 1.127 in sq [1 oz] including traces).
- Pulse Test: Pulse Width ≤ 300 μs, Duty Cycle ≤ 2%.
- Switching characteristics are independent of operating junction temperatures.
- ESD between the gate and source serves only, no gate overvoltage rating is implied.

# NTD6416AN, NVD6416AN

## TYPICAL CHARACTERISTICS

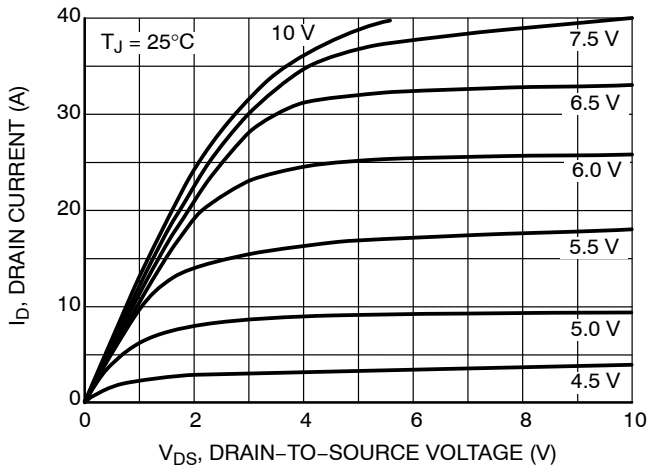

Figure 1. On-Region Characteristics

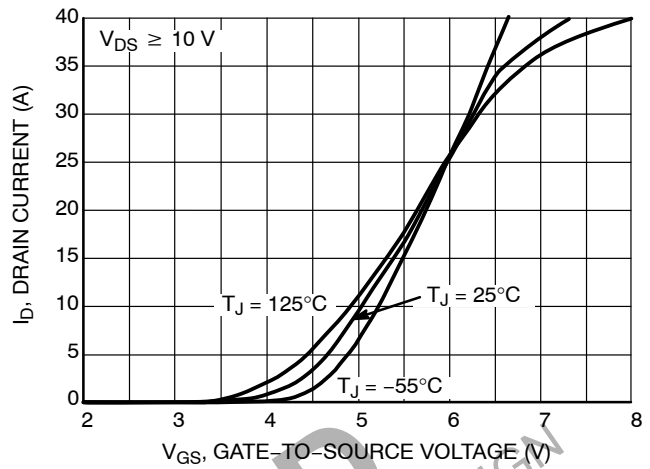

Figure 2. Transfer Characteristics

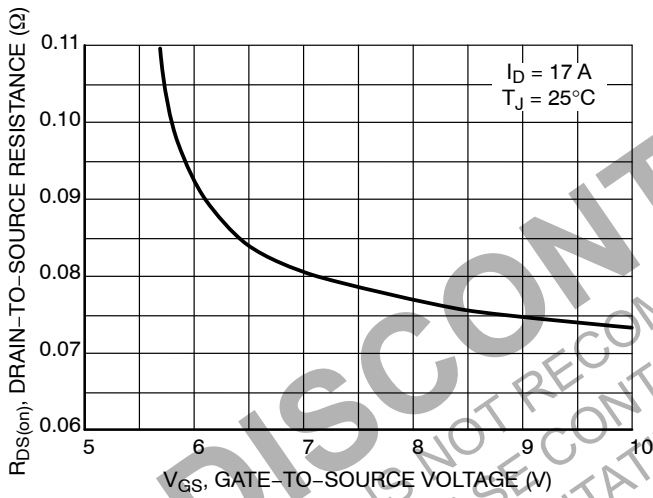

Figure 3. On-Region versus Gate Voltage

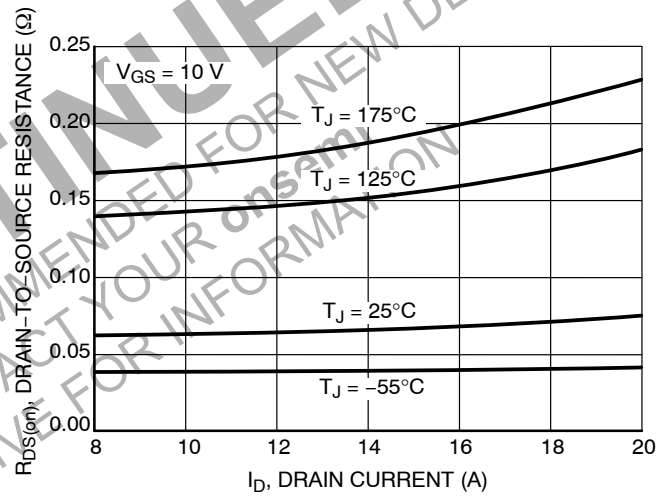

Figure 4. On-Resistance versus Drain Current and Gate Voltage

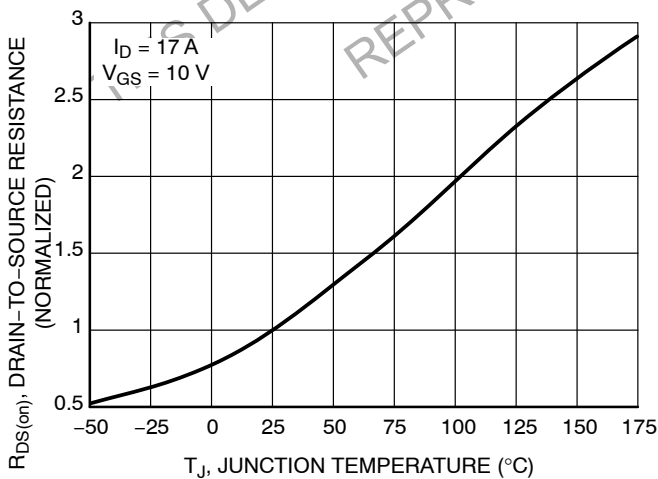

Figure 5. On-Resistance Variation with Temperature

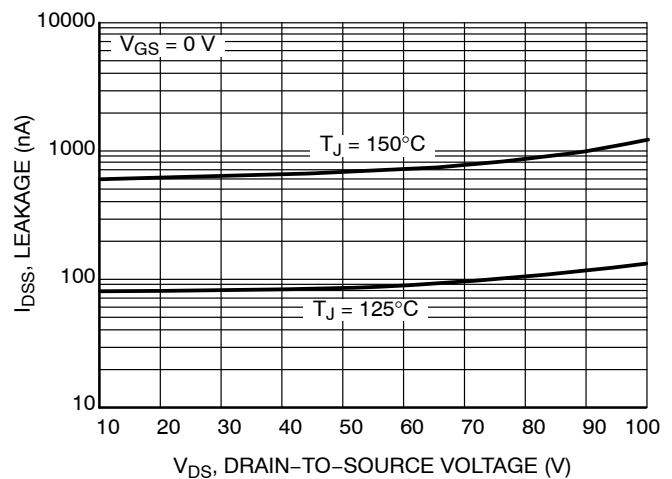
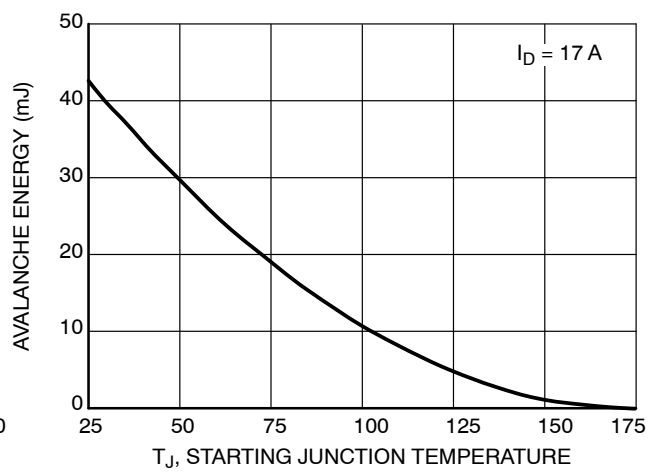
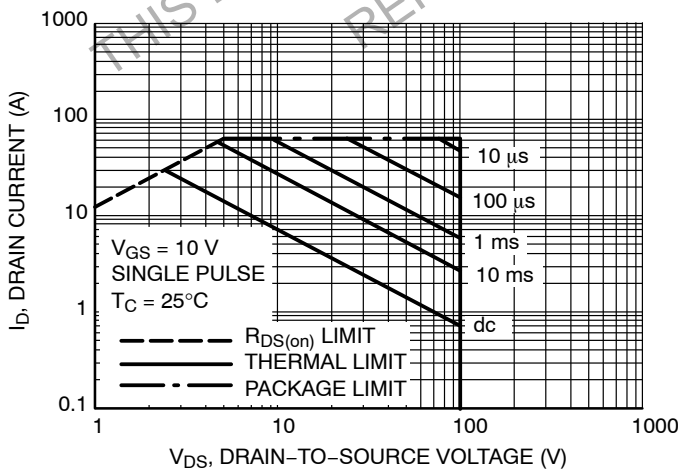
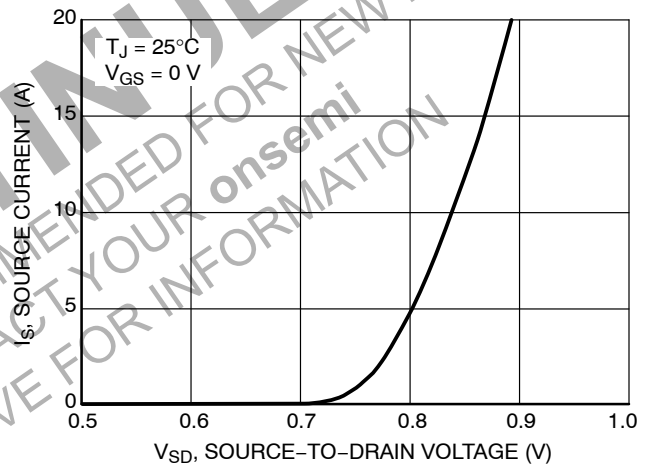
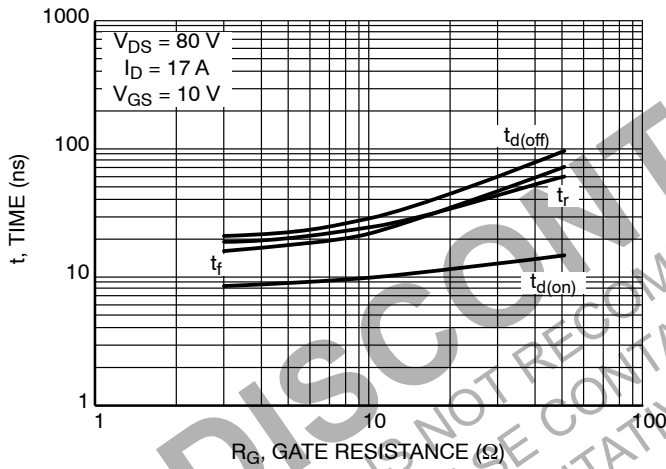
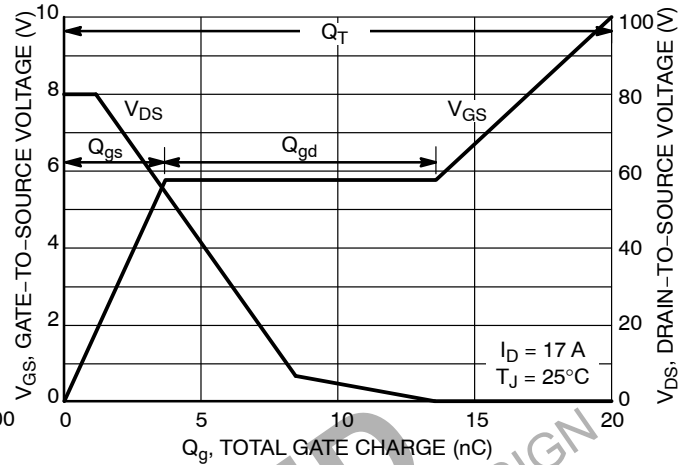
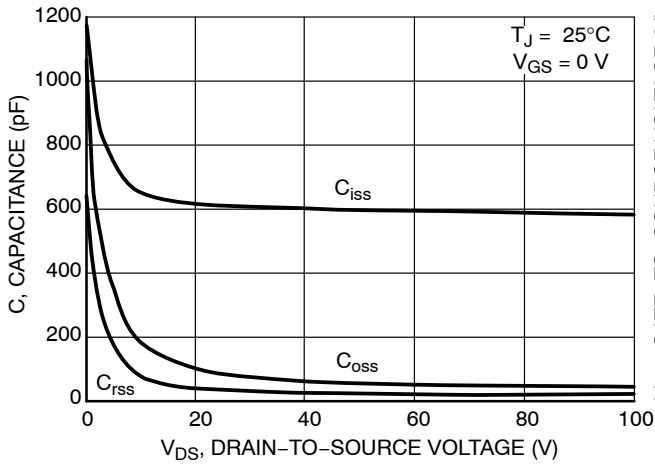

Figure 6. Drain-to-Source Leakage Current versus Voltage

# NTD6416AN, NVD6416AN

## TYPICAL CHARACTERISTICS



# NTD6416AN, NVD6416AN

## TYPICAL CHARACTERISTICS

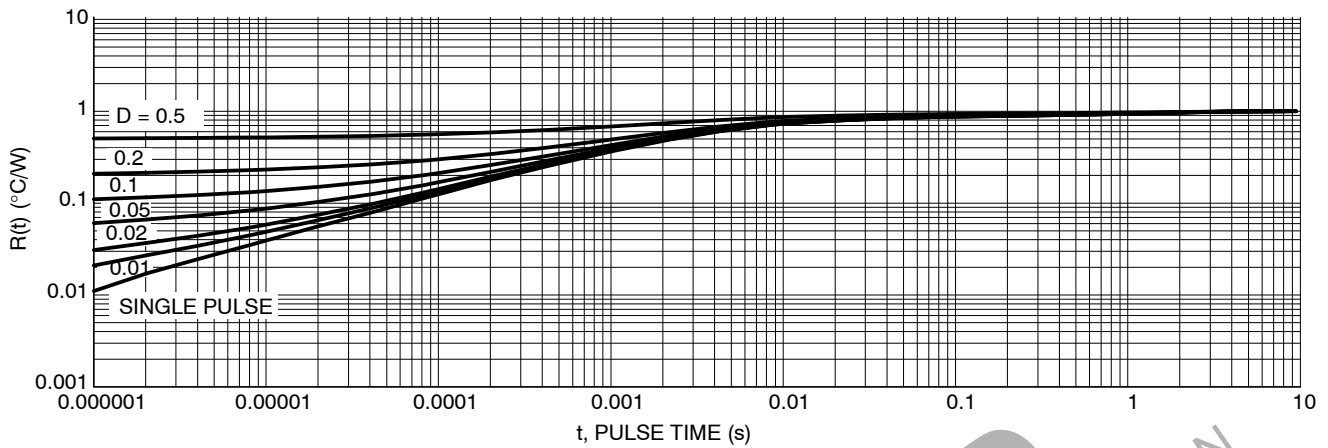

Figure 13. Thermal Response

### ORDERING INFORMATION

| Device             | Package           | Shipping†          |
|--------------------|-------------------|--------------------|
| NTD6416ANT4G       | DPAK<br>(Pb-Free) | 2500 / Tape & Reel |
| NTD6416AN-1G       | IPAK<br>(Pb-Free) | 75 Units / Rail    |
| NVD6416ANT4G*      | DPAK<br>(Pb-Free) | 2500 / Tape & Reel |
| NVD6416ANT4G-VF01* | DPAK<br>(Pb-Free) | 2500 / Tape & Reel |

†For information on tape and reel specifications, including part orientation and tape sizes, please refer to our Tape and Reel Packaging Specification Brochure, BRD8011/D.

\*NVD Prefix for Automotive and Other Applications Requiring Unique Site and Control Change Requirements; AEC-Q101 Qualified and PPAP Capable.

# MECHANICAL CASE OUTLINE

## PACKAGE DIMENSIONS

ON Semiconductor®

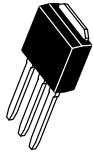

### IPAK CASE 369D-01 ISSUE C

DATE 15 DEC 2010

SCALE 1:1

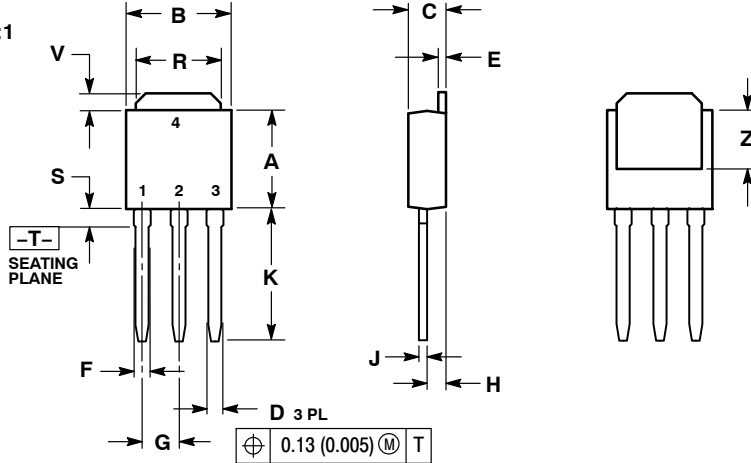

- NOTES:
1. DIMENSIONING AND TOLERANCING PER ANSI Y14.5M, 1982.
  2. CONTROLLING DIMENSION: INCH.

| DIM | INCHES |       | MILLIMETERS |      |
|-----|--------|-------|-------------|------|
|     | MIN    | MAX   | MIN         | MAX  |
| A   | 0.235  | 0.245 | 5.97        | 6.35 |
| B   | 0.250  | 0.265 | 6.35        | 6.73 |
| C   | 0.086  | 0.094 | 2.19        | 2.38 |
| D   | 0.027  | 0.035 | 0.69        | 0.88 |
| E   | 0.018  | 0.023 | 0.46        | 0.58 |
| F   | 0.037  | 0.045 | 0.94        | 1.14 |
| G   | 0.090  | BSC   | 2.29        | BSC  |
| H   | 0.034  | 0.040 | 0.87        | 1.01 |
| J   | 0.018  | 0.023 | 0.46        | 0.58 |
| K   | 0.350  | 0.380 | 8.89        | 9.65 |
| R   | 0.180  | 0.215 | 4.45        | 5.45 |
| S   | 0.025  | 0.040 | 0.63        | 1.01 |
| V   | 0.035  | 0.050 | 0.89        | 1.27 |
| Z   | 0.155  | ---   | 3.93        | ---  |

- STYLE 1:  
PIN 1. BASE  
2. COLLECTOR  
3. EMITTER  
4. COLLECTOR
- STYLE 2:  
PIN 1. GATE  
2. DRAIN  
3. SOURCE  
4. DRAIN
- STYLE 3:  
PIN 1. ANODE  
2. CATHODE  
3. ANODE  
4. CATHODE
- STYLE 4:  
PIN 1. CATHODE  
2. ANODE  
3. GATE  
4. ANODE
- STYLE 5:  
PIN 1. GATE  
2. ANODE  
3. CATHODE  
4. ANODE
- STYLE 6:  
PIN 1. MT1  
2. MT2  
3. GATE  
4. MT2
- STYLE 7:  
PIN 1. GATE  
2. COLLECTOR  
3. EMITTER  
4. COLLECTOR

### MARKING DIAGRAMS

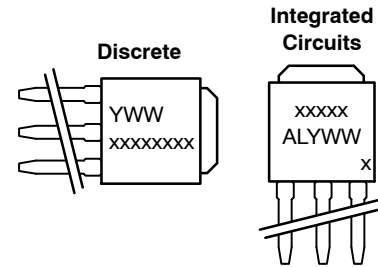

- xxxxxxxxx = Device Code  
A = Assembly Location  
IL = Wafer Lot  
Y = Year  
WW = Work Week

|                         |                                    |   |
|-------------------------|------------------------------------|---|
| <b>DOCUMENT NUMBER:</b> | <b>98AON10528D</b>                 | Electronic versions are uncontrolled except when accessed directly from the Document Repository.<br>Printed versions are uncontrolled except when stamped "CONTROLLED COPY" in red. |
| <b>DESCRIPTION:</b>     | <b>IPAK (DPAK INSERTION MOUNT)</b> | <b>PAGE 1 OF 1</b>  |

ON Semiconductor and are trademarks of Semiconductor Components Industries, LLC dba ON Semiconductor or its subsidiaries in the United States and/or other countries. ON Semiconductor reserves the right to make changes without further notice to any products herein. ON Semiconductor makes no warranty, representation or guarantee regarding the suitability of its products for any particular purpose, nor does ON Semiconductor assume any liability arising out of the application or use of any product or circuit, and specifically disclaims any and all liability, including without limitation special, consequential or incidental damages. ON Semiconductor does not convey any license under its patent rights nor the rights of others.

# MECHANICAL CASE OUTLINE

## PACKAGE DIMENSIONS

ON Semiconductor®

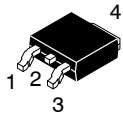

SCALE 1:1

### DPAK (SINGLE GAUGE)

#### CASE 369AA-01

#### ISSUE B

DATE 03 JUN 2010

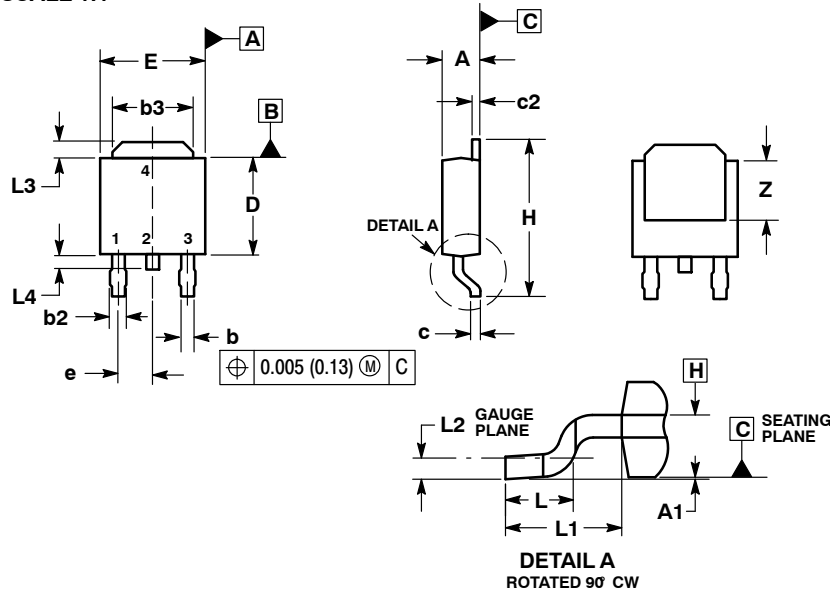

NOTES:

- DIMENSIONING AND TOLERANCING PER ASME Y14.5M, 1994.
- CONTROLLING DIMENSION: INCHES.
- THERMAL PAD CONTOUR OPTIONAL WITHIN DIMENSIONS b3, L3 and Z.
- DIMENSIONS D AND E DO NOT INCLUDE MOLD FLASH, PROTRUSIONS, OR BURRS. MOLD FLASH, PROTRUSIONS, OR GATE BURRS SHALL NOT EXCEED 0.006 INCHES PER SIDE.
- DIMENSIONS D AND E ARE DETERMINED AT THE OUTERMOST EXTREMES OF THE PLASTIC BODY.
- DATUMS A AND B ARE DETERMINED AT DATUM PLANE H.

| DIM | INCHES    |       | MILLIMETERS |       |
|-----|-----------|-------|-------------|-------|
|     | MIN       | MAX   | MIN         | MAX   |
| A   | 0.086     | 0.094 | 2.18        | 2.38  |
| A1  | 0.000     | 0.005 | 0.00        | 0.13  |
| b   | 0.025     | 0.035 | 0.63        | 0.89  |
| b2  | 0.030     | 0.045 | 0.76        | 1.14  |
| b3  | 0.180     | 0.215 | 4.57        | 5.46  |
| c   | 0.018     | 0.024 | 0.46        | 0.61  |
| c2  | 0.018     | 0.024 | 0.46        | 0.61  |
| D   | 0.235     | 0.245 | 5.97        | 6.22  |
| E   | 0.250     | 0.265 | 6.35        | 6.73  |
| e   | 0.090 BSC |       | 2.29 BSC    |       |
| H   | 0.370     | 0.410 | 9.40        | 10.41 |
| L   | 0.055     | 0.070 | 1.40        | 1.78  |
| L1  | 0.108 REF |       | 2.74 REF    |       |
| L2  | 0.020 BSC |       | 0.51 BSC    |       |
| L3  | 0.035     | 0.050 | 0.89        | 1.27  |
| L4  | ---       | 0.040 | ---         | 1.01  |
| Z   | 0.155     | ---   | 3.93        | ---   |

- |  |   |  |  |
|--|---|--|--|
| <p>STYLE 1:<br/>PIN 1. BASE<br/>2. COLLECTOR<br/>3. EMITTER<br/>4. COLLECTOR</p> | <p>STYLE 2:<br/>PIN 1. GATE<br/>2. DRAIN<br/>3. SOURCE<br/>4. DRAIN</p> | <p>STYLE 3:<br/>PIN 1. ANODE<br/>2. CATHODE<br/>3. ANODE<br/>4. CATHODE</p>  | <p>STYLE 4:<br/>PIN 1. CATHODE<br/>2. ANODE<br/>3. GATE<br/>4. ANODE</p> |
| <p>STYLE 5:<br/>PIN 1. GATE<br/>2. ANODE<br/>3. CATHODE<br/>4. ANODE</p>         | <p>STYLE 6:<br/>PIN 1. MT1<br/>2. MT2<br/>3. GATE<br/>4. MT2</p>        | <p>STYLE 7:<br/>PIN 1. GATE<br/>2. ANODE<br/>3. EMITTER<br/>4. COLLECTOR</p> |  |

### GENERIC MARKING DIAGRAM\*

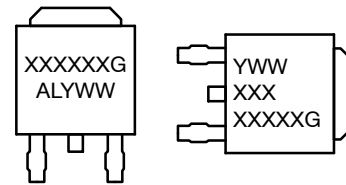

IC Discrete

- XXXXXX = Device Code
- A = Assembly Location
- L = Wafer Lot
- Y = Year
- WW = Work Week
- G = Pb-Free Package

\*This information is generic. Please refer to device data sheet for actual part marking.

### SOLDERING FOOTPRINT\*

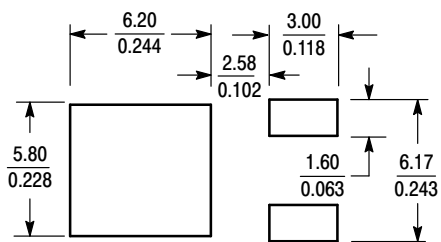

SCALE 3:1 (mm/inches)

\*For additional information on our Pb-Free strategy and soldering details, please download the ON Semiconductor Soldering and Mounting Techniques Reference Manual, SOLDERRM/D.

|                  |                     |  |
|------------------|---------------------|--|
| DOCUMENT NUMBER: | 98AON13126D         | Electronic versions are uncontrolled except when accessed directly from the Document Repository. Printed versions are uncontrolled except when stamped "CONTROLLED COPY" in red. |
| DESCRIPTION:     | DPAK (SINGLE GAUGE) | PAGE 1 OF 1  |

ON Semiconductor and ON are trademarks of Semiconductor Components Industries, LLC dba ON Semiconductor or its subsidiaries in the United States and/or other countries. ON Semiconductor reserves the right to make changes without further notice to any products herein. ON Semiconductor makes no warranty, representation or guarantee regarding the suitability of its products for any particular purpose, nor does ON Semiconductor assume any liability arising out of the application or use of any product or circuit, and specifically disclaims any and all liability, including without limitation special, consequential or incidental damages. ON Semiconductor does not convey any license under its patent rights nor the rights of others.

**onsemi**, **Onsemi**, and other names, marks, and brands are registered and/or common law trademarks of Semiconductor Components Industries, LLC dba "**onsemi**" or its affiliates and/or subsidiaries in the United States and/or other countries. **onsemi** owns the rights to a number of patents, trademarks, copyrights, trade secrets, and other intellectual property. A listing of **onsemi**'s product/patent coverage may be accessed at [www.onsemi.com/site/pdf/Patent-Marking.pdf](http://www.onsemi.com/site/pdf/Patent-Marking.pdf). **onsemi** reserves the right to make changes at any time to any products or information herein, without notice. The information herein is provided "as-is" and **onsemi** makes no warranty, representation or guarantee regarding the accuracy of the information, product features, availability, functionality, or suitability of its products for any particular purpose, nor does **onsemi** assume any liability arising out of the application or use of any product or circuit, and specifically disclaims any and all liability, including without limitation special, consequential or incidental damages. Buyer is responsible for its products and applications using **onsemi** products, including compliance with all laws, regulations and safety requirements or standards, regardless of any support or applications information provided by **onsemi**. "Typical" parameters which may be provided in **onsemi** data sheets and/or specifications can and do vary in different applications and actual performance may vary over time. All operating parameters, including "Typicals" must be validated for each customer application by customer's technical experts. **onsemi** does not convey any license under any of its intellectual property rights nor the rights of others. **onsemi** products are not designed, intended, or authorized for use as a critical component in life support systems or any FDA Class 3 medical devices or medical devices with a same or similar classification in a foreign jurisdiction or any devices intended for implantation in the human body. Should Buyer purchase or use **onsemi** products for any such unintended or unauthorized application, Buyer shall indemnify and hold **onsemi** and its officers, employees, subsidiaries, affiliates, and distributors harmless against all claims, costs, damages, and expenses, and reasonable attorney fees arising out of, directly or indirectly, any claim of personal injury or death associated with such unintended or unauthorized use, even if such claim alleges that **onsemi** was negligent regarding the design or manufacture of the part. **onsemi** is an Equal Opportunity/Affirmative Action Employer. This literature is subject to all applicable copyright laws and is not for resale in any manner.

## ADDITIONAL INFORMATION

### TECHNICAL PUBLICATIONS:

Technical Library: [www.onsemi.com/design/resources/technical-documentation](http://www.onsemi.com/design/resources/technical-documentation)  
onsemi Website: [www.onsemi.com](http://www.onsemi.com)

### ONLINE SUPPORT: [www.onsemi.com/support](http://www.onsemi.com/support)

For additional information, please contact your local Sales Representative at [www.onsemi.com/support/sales](http://www.onsemi.com/support/sales)

## Looking for pricing, stock, or lifecycle information?

Click below to explore more details on WIN SOURCE:

 [View NTD6416AN-1G on WIN SOURCE](#)

 [ON Semiconductor](#) Information

## Optimize Your Supply Chain with WIN SOURCE Solutions

-  Global Sourcing Solution
-  Obsolete Management
-  Cost Control Management
-  Shortage Management
-  Alternative Solution
-  Excess Inventory Management