



**THE DATASHEET OF
BF2040R E6814**



Silicon N-Channel MOSFET Tetrode

- For low noise , high gain controlled input stages up to 1GHz
- Operating voltage 5 V
- Pb-free (RoHS compliant) package
- Qualified according AEC Q101

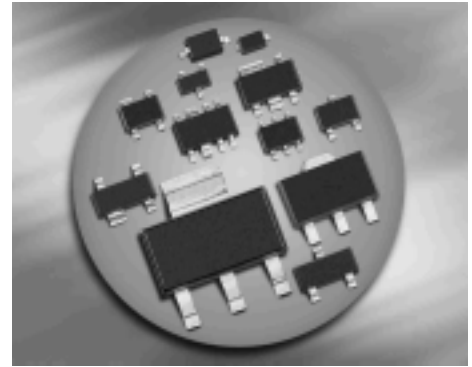

ESD (Electrostatic discharge) sensitive device, observe handling precaution!

Type	Package	Pin Configuration						Marking
BF2040	SOT143	1=S	2=D	3=G2	4=G1	-	-	NFs
BF2040R	SOT143R	1=D	2=S	3=G1	4=G2	-	-	NFs
BF2040W	SOT343	1=D	2=S	3=G1	4=G2	-	-	NFs

Maximum Ratings

Parameter	Symbol	Value	Unit
Drain-source voltage	V_{DS}	8	V
Continuous drain current	I_D	40	mA
Gate 1/ gate 2-source current	$\pm I_{G1/2SM}$	10	
Gate 1 (external biasing)	$+V_{G1SE}$	7	V
Total power dissipation	P_{tot}		mW
$T_S \leq 76 \text{ }^\circ\text{C}$, BF2040, BF2040R		200	
$T_S \leq 94 \text{ }^\circ\text{C}$, BF2040W		200	
Storage temperature	T_{stg}	-55 ... 150	$^\circ\text{C}$
Channel temperature	T_{ch}	150	

Thermal Resistance

Parameter	Symbol	Value	Unit
Channel - soldering point ¹⁾	R_{thchs}		K/W
BF2040, BF2040R		≤ 370	
BF2040W		≤ 280	

¹⁾For calculation of R_{thJA} please refer to Application Note Thermal Resistance

Electrical Characteristics at $T_A = 25^\circ\text{C}$, unless otherwise specified

Parameter	Symbol	Values			Unit
		min.	typ.	max.	
DC Characteristics					
Drain-source breakdown voltage $I_D = 20 \mu\text{A}$, $V_{G1S} = 0$, $V_{G2S} = 0$	$V_{(BR)DS}$	10	-	-	V
Gate1-source breakdown voltage $+I_{G1S} = 10 \text{ mA}$, $V_{G2S} = 0$, $V_{DS} = 0$	$+V_{(BR)G1SS}$	6	-	15	
Gate2-source breakdown voltage $+I_{G2S} = 10 \text{ mA}$, $V_{G1S} = 0$, $V_{DS} = 0$	$+V_{(BR)G2SS}$	6	-	15	
Gate1-source leakage current $V_{G1S} = 5 \text{ V}$, $V_{G2S} = 0$, $V_{DS} = 0$	$+I_{G1SS}$	-	-	50	nA
Gate2-source leakage current $V_{G2S} = 5 \text{ V}$, $V_{G1S} = 0$, $V_{DS} = 0$	$+I_{G2SS}$	-	-	50	
Drain current $V_{DS} = 5 \text{ V}$, $V_{G1S} = 0$, $V_{G2S} = 4 \text{ V}$	I_{DSS}	-	-	50	μA
Drain-source current $V_{DS} = 5 \text{ V}$, $V_{G2S} = 4 \text{ V}$, $R_{G1} = 100 \text{ k}\Omega$	I_{DSX}	-	15	-	mA
Gate1-source pinch-off voltage $V_{DS} = 5 \text{ V}$, $V_{G2S} = 4 \text{ V}$, $I_D = 20 \mu\text{A}$	$V_{G1S(p)}$	0.3	0.6	-	V
Gate2-source pinch-off voltage $V_{DS} = 5 \text{ V}$, $I_D = 20 \mu\text{A}$	$V_{G2S(p)}$	0.3	0.7	-	

Electrical Characteristics at $T_A = 25^\circ\text{C}$, unless otherwise specified

Parameter	Symbol	Values			Unit
		min.	typ.	max.	
AC Characteristics - (verified by random sampling)					
Forward transconductance $V_{DS} = 5\text{ V}, I_D = 15\text{ mA}, V_{G2S} = 4\text{ V}$	g_{fs}	37	42	-	mS
Gate1 input capacitance $V_{DS} = 5\text{ V}, I_D = 15\text{ mA}, V_{G2S} = 4\text{ V},$ $f = 10\text{ MHz}$	C_{g1ss}	-	2.9	3.4	pF
Output capacitance $V_{DS} = 5\text{ V}, I_D = 15\text{ mA}, V_{G2S} = 4\text{ V},$ $f = 10\text{ MHz}$	C_{dss}	-	1.6	-	
Power gain $V_{DS} = 5\text{ V}, I_D = 15\text{ mA}, V_{G2S} = 4\text{ V},$ $f = 800\text{ MHz}$	G_p	20	23	-	dB
Noise figure $V_{DS} = 5\text{ V}, I_D = 15\text{ mA}, V_{G2S} = 4\text{ V},$ $f = 800\text{ MHz}$	F	-	1.6	2.2	dB
Gain control range $V_{DS} = 5\text{ V}, V_{G2S} = 4 \dots 0\text{ V}, f = 800\text{ GHz}$	ΔG_p	45	50	-	

Total power dissipation $P_{tot} = f(T_S)$

BF2040, BFD2040R

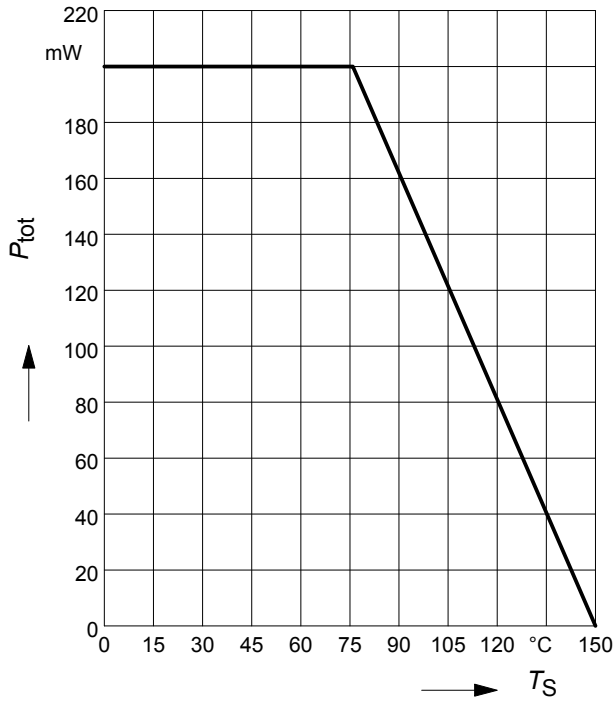
Total power dissipation $P_{tot} = f(T_S)$

BF2040W

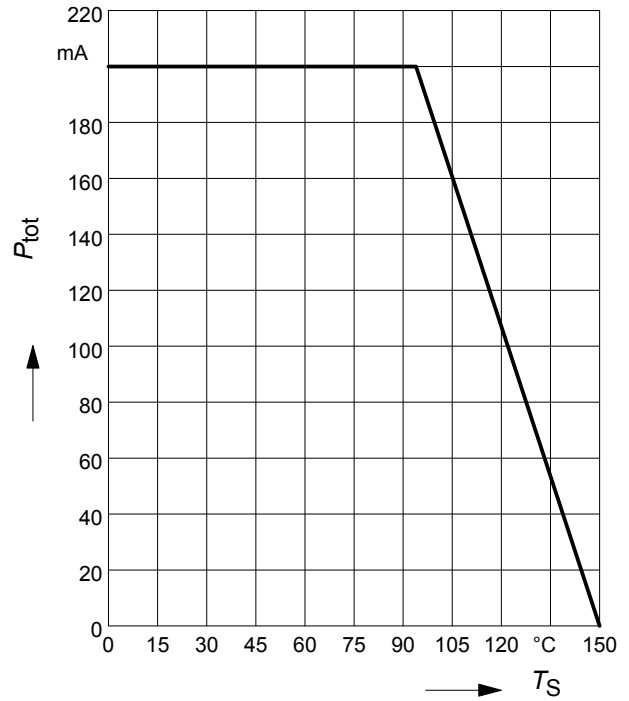
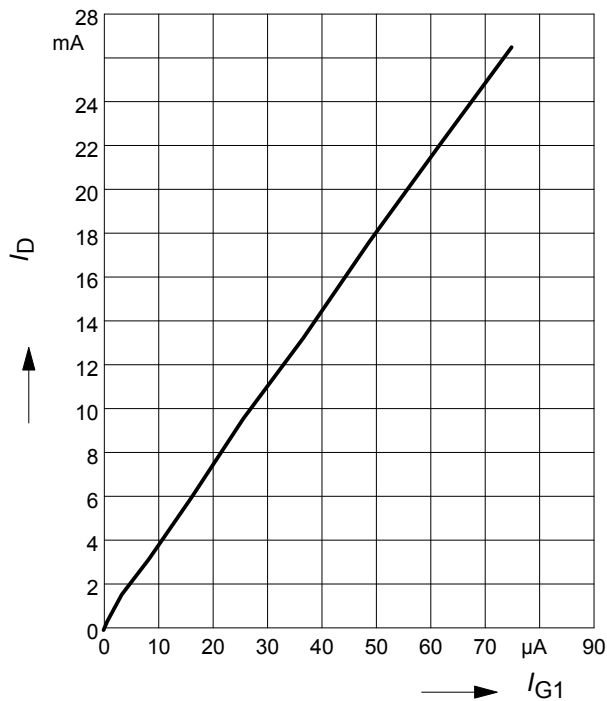
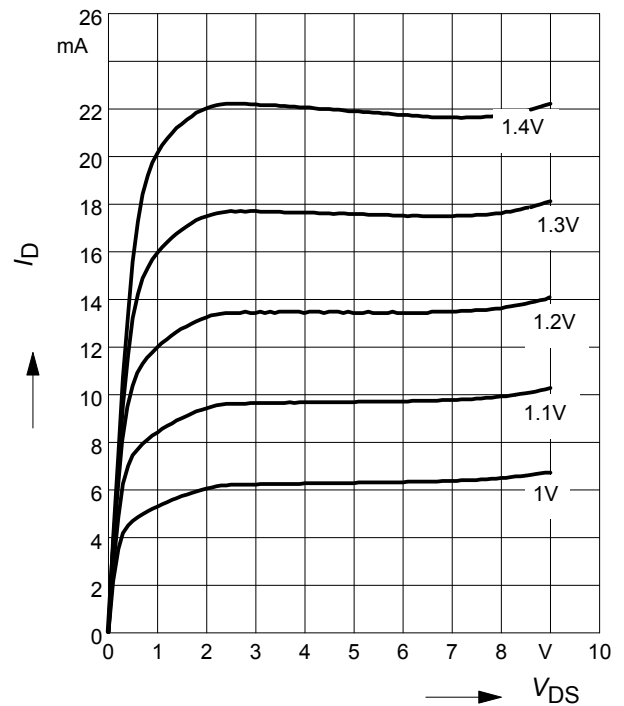
Drain current $I_D = f(I_{G1})$
 $V_{G2S} = 4V$

Output characteristics $I_D = f(V_{DS})$
 $V_{G2S} = 4 V$
 $V_{G1S} = \text{Parameter}$

Gate 1 current $I_{G1} = f(V_{G1S})$

$V_{DS} = 5V$

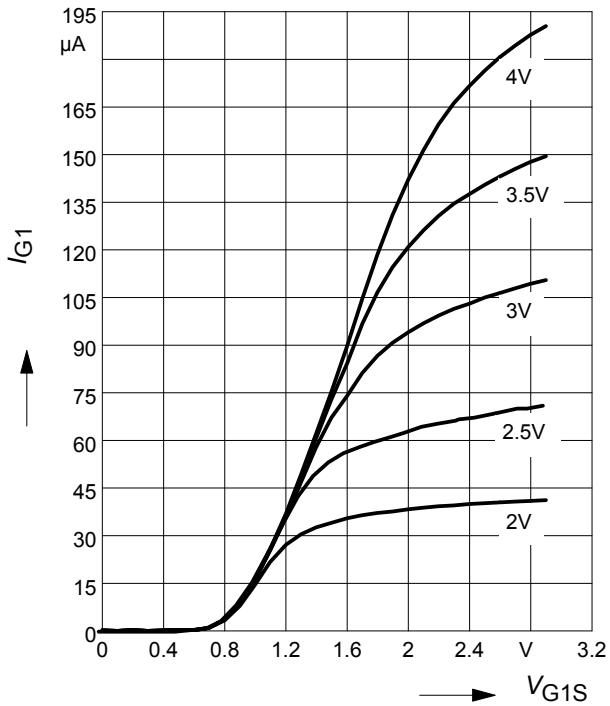
$V_{G2S} = \text{Parameter}$



Gate 1 forward transconductance

$g_{fs} = f(I_D)$

$V_{DS} = 5V, V_{G2S} = \text{Parameter}$

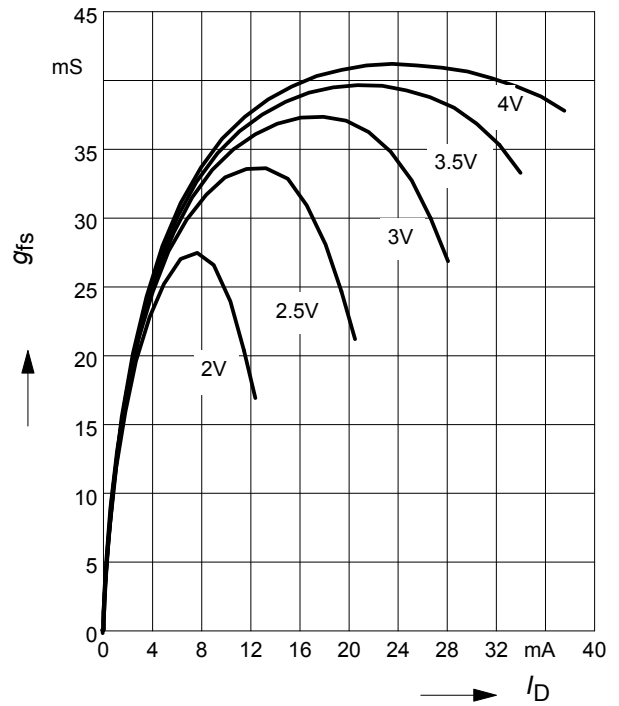

Drain current $I_D = f(V_{G1S})$

$V_{DS} = 5V$

$V_{G2S} = \text{Parameter}$

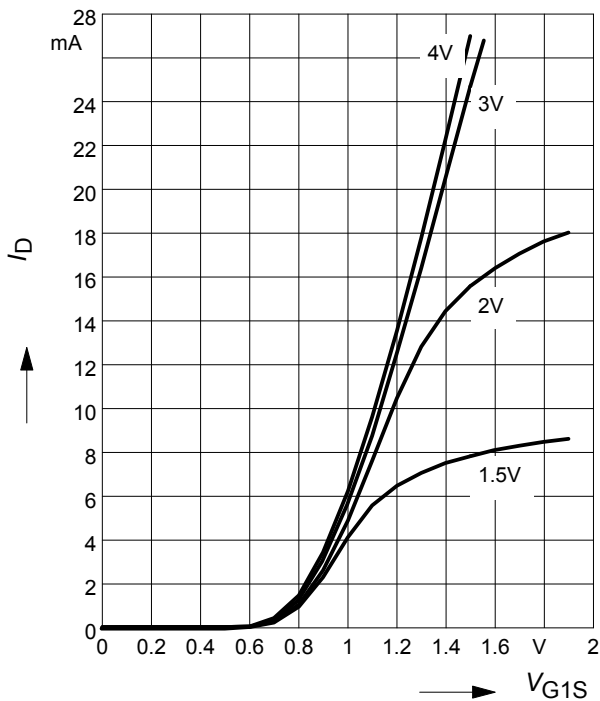

Drain current $I_D = f(V_{GG})$

$V_{DS} = 5V, V_{G2S} = 4V, R_{G1} = 80k\Omega$

(connected to V_{GG} , $V_{GG} = \text{gate1 supply voltage}$)

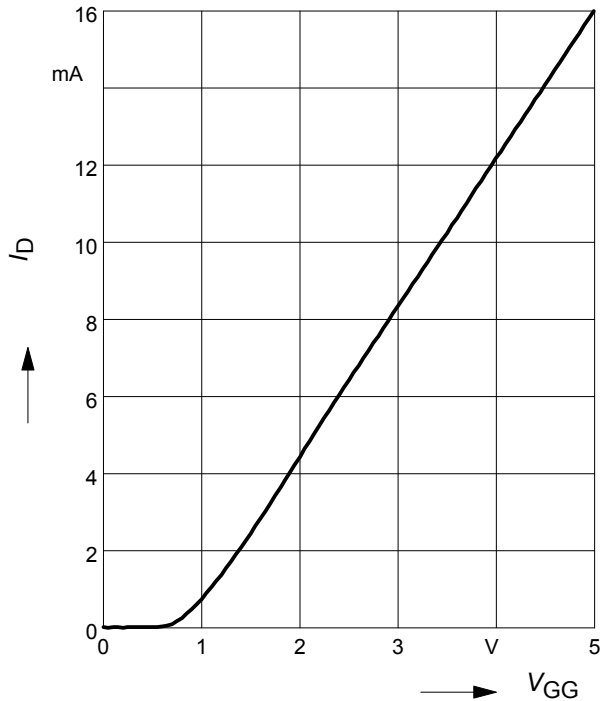

Drain current $I_D = f(V_{GG})$

$V_{G2S} = 4V$

$R_{G1} = \text{Parameter in } k\Omega$

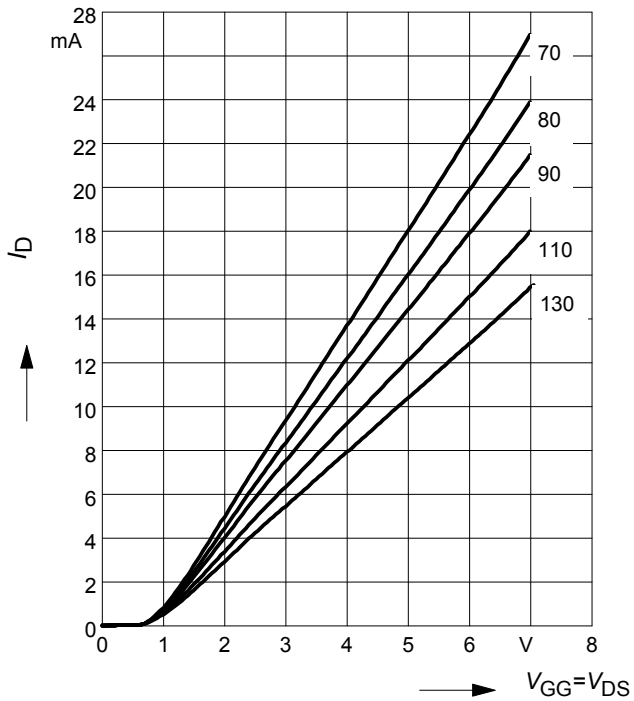

Crossmodulation $V_{unw} = (AGC)$

$V_{DS} = 5 V$

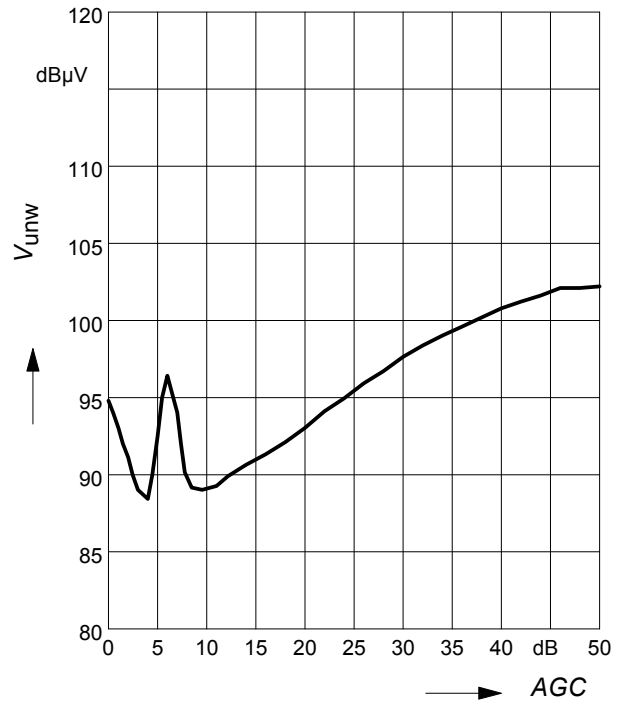

Cossmodulation test circuit

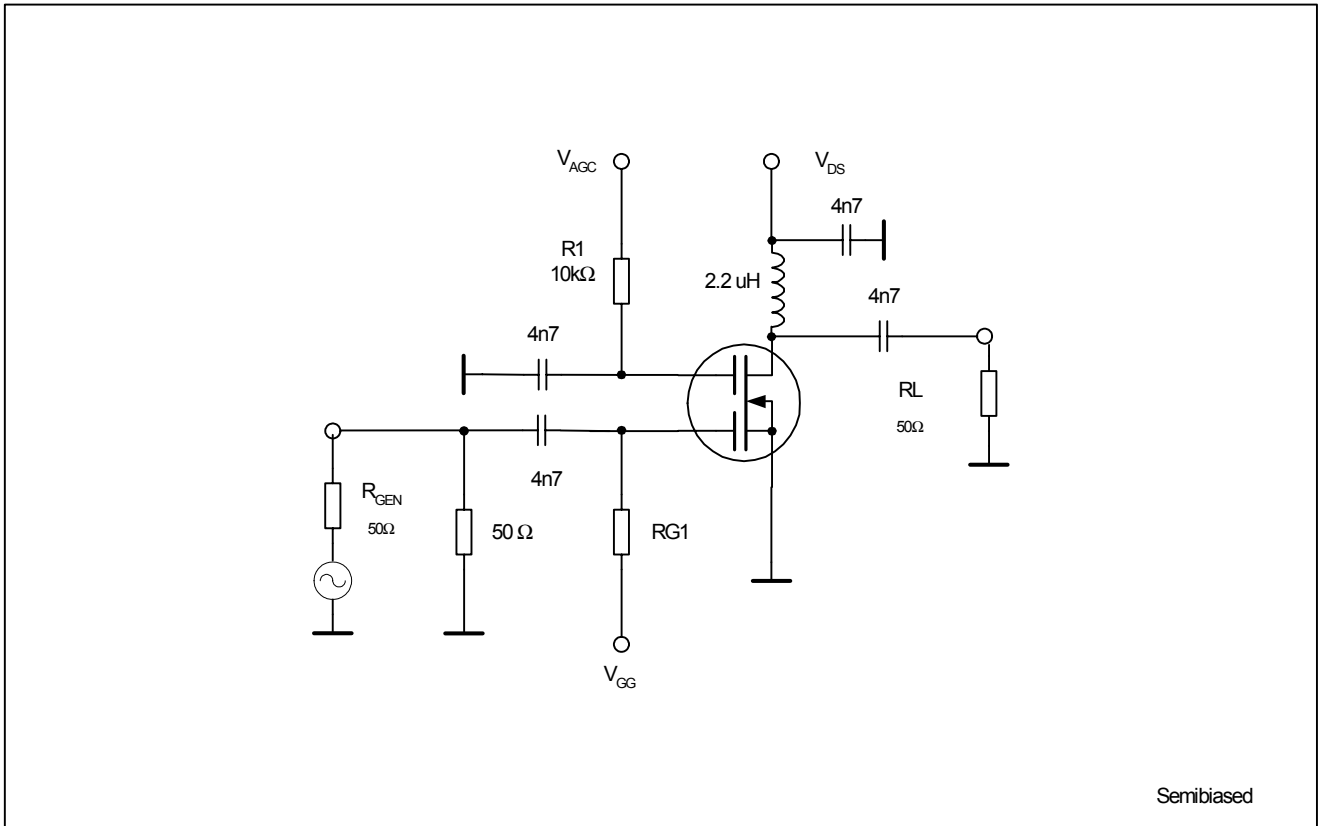

Package Outline

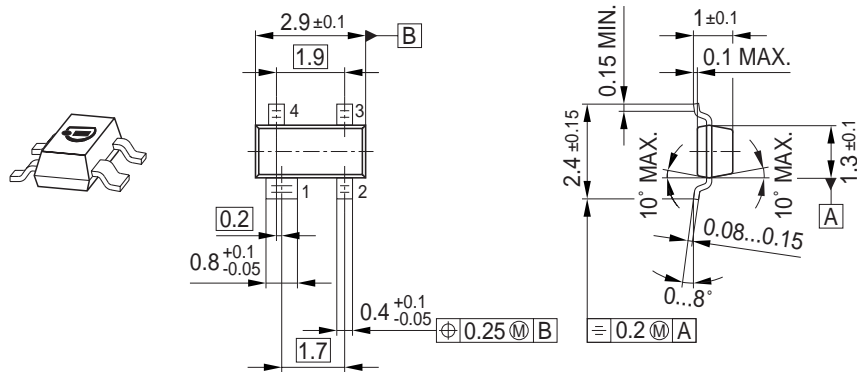

Foot Print

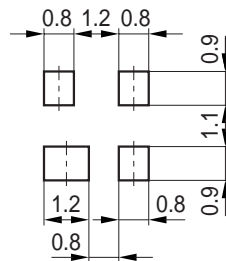

Marking Layout (Example)

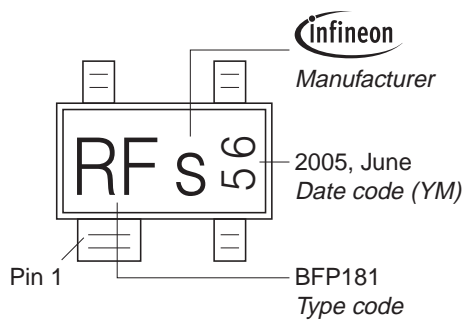

Standard Packing

Reel $\varnothing 180$ mm = 3.000 Pieces/Reel
 Reel $\varnothing 330$ mm = 10.000 Pieces/Reel

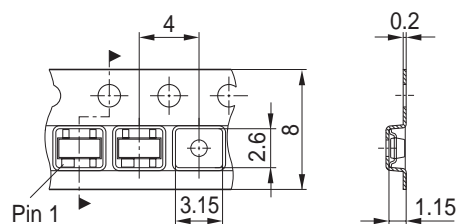

Package Outline

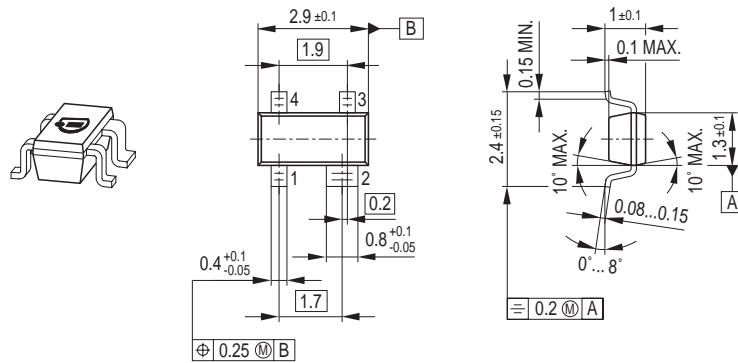

Foot Print

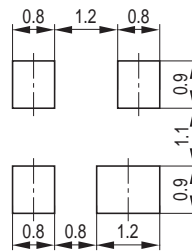

Marking Layout (Example)

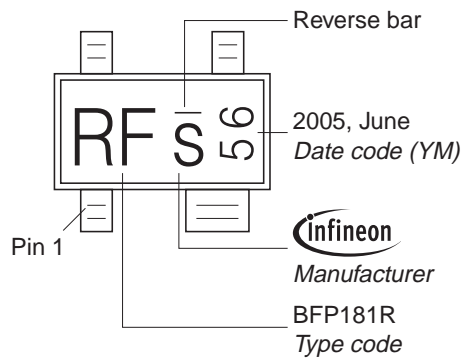

Standard Packing

Reel \varnothing 180 mm = 3.000 Pieces/Reel
 Reel \varnothing 330 mm = 10.000 Pieces/Reel

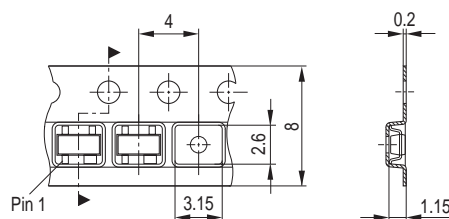

Package Outline

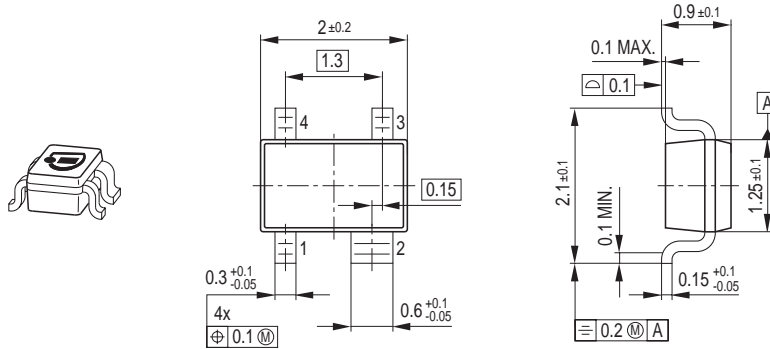

Foot Print

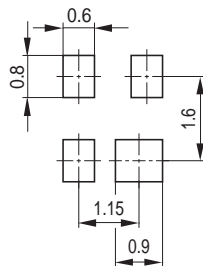

Marking Layout (Example)

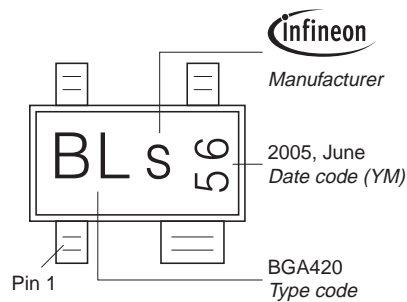

Standard Packing

Reel ø180 mm = 3.000 Pieces/Reel
 Reel ø330 mm = 10.000 Pieces/Reel

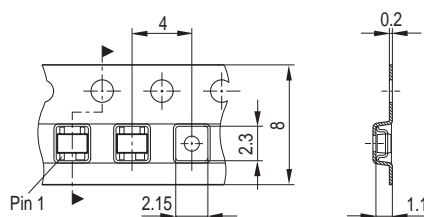

Edition 2006-02-01
Published by
Infineon Technologies AG
81726 München, Germany
© Infineon Technologies AG 2007.
All Rights Reserved.

Attention please!

The information given in this dokument shall in no event be regarded as a guarantee of conditions or characteristics ("Beschaffenheitsgarantie"). With respect to any examples or hints given herein, any typical values stated herein and/or any information regarding the application of the device, Infineon Technologies hereby disclaims any and all warranties and liabilities of any kind, including without limitation warranties of non-infringement of intellectual property rights of any third party.

Information

For further information on technology, delivery terms and conditions and prices please contact your nearest Infineon Technologies Office (www.infineon.com).

Warnings

Due to technical requirements components may contain dangerous substances. For information on the types in question please contact your nearest Infineon Technologies Office.

Infineon Technologies Components may only be used in life-support devices or systems with the express written approval of Infineon Technologies, if a failure of such components can reasonably be expected to cause the failure of that life-support device or system, or to affect the safety or effectiveness of that device or system.

Life support devices or systems are intended to be implanted in the human body, or to support and/or maintain and sustain and/or protect human life. If they fail, it is reasonable to assume that the health of the user or other persons may be endangered.

Looking for pricing, stock, or lifecycle information?

Click below to explore more details on WIN SOURCE:

-  [View BF2040R E6814 on WIN SOURCE](#)
-  [Infineon Technologies Information](#)

Optimize Your Supply Chain with WIN SOURCE Solutions

-  Global Sourcing Solution
-  Obsolete Management
-  Cost Control Management
-  Shortage Management
-  Alternative Solution
-  Excess Inventory Management