



**THE DATASHEET OF
PR3001-T**



Features

- Diffused Junction
- Fast Switching for High Efficiency
- Surge Overload Rating to 150 A Peak
- Low Reverse Leakage Current
- Lead Free Finish, RoHS Compliant (Note 4)**

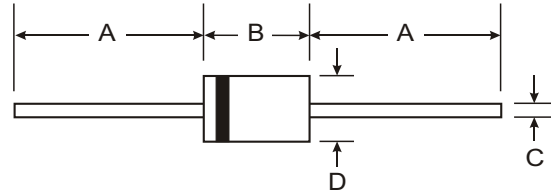

Mechanical Data

- Case: DO-201AD
- Case Material: Molded Plastic. UL Flammability Classification Rating 94V-0
- Moisture Sensitivity: Level 1 per J-STD-020C
- Terminals: Finish - Tin. Plated Leads Solderable per MIL-STD-202, Method 208 **e3**
- Polarity: Cathode Band
- Marking: Type Number
- Ordering Information: See Page 3
- Weight: 1.12 grams (approximate)

DO-201AD		
Dim	Min	Max
A	25.40	
B	7.20	9.50
C	1.20	1.30
D	4.80	5.30
All Dimensions in mm		

Maximum Ratings and Electrical Characteristics @ T_A = 25 C unless otherwise specified

Single phase, half wave, 60Hz, resistive or inductive load.
For capacitive load, derate current by 20%.

Characteristic	Symbol	PR 3001	PR 3002	PR 3003	PR 3004	PR 3005	Unit
Peak Repetitive Reverse Voltage	V _{RRM}	50	100	200	400	600	V
Working Peak Reverse Voltage	V _{RWM}						
DC Blocking Voltage (Note 5)	V _R						
RMS Reverse Voltage	V _{R(RMS)}	35	70	140	280	420	V
Average Rectified Output Current (Note 1)	I _O	3.0					A
@ T _A = 90 C							
Non-Repetitive Peak Forward Surge Current	I _{FSM}	150					A
8.3ms Single half sine-wave Superimposed on Rated Load							
Forward Voltage	V _{FM}	1.2					V
@ I _F = 3.0A							
Peak Reverse Current	I _{RM}	5.0					A
@ T _A = 25 C							
at Rated DC Blocking Voltage (Note 5)							
@ T _A = 100 C		100					
Reverse Recovery Time (Note 3)	t _{rr}	150				250	ns
Typical Total Capacitance (Note 2)	C _T	50					pF
Typical Thermal Resistance Junction to Ambient	R _{JA}	15					°C/W
Operating and Storage Temperature Range	T _j , T _{STG}	-65 to +150					C

- Notes:
1. Valid provided that leads are maintained at ambient temperature at a distance of 9.5mm from the case.
 2. Measured at 1.0MHz and applied reverse voltage of 4.0V DC.
 3. Measured with I_F = 0.5A, I_R = 1.0A, I_{rr} = 0.25A. See figure 5.
 4. RoHS revision 13.2.2003. High temperature solder exemption applied, see *EU Directive Annex Note 7*.
 5. Short duration pulse test used to minimize self-heating effect.

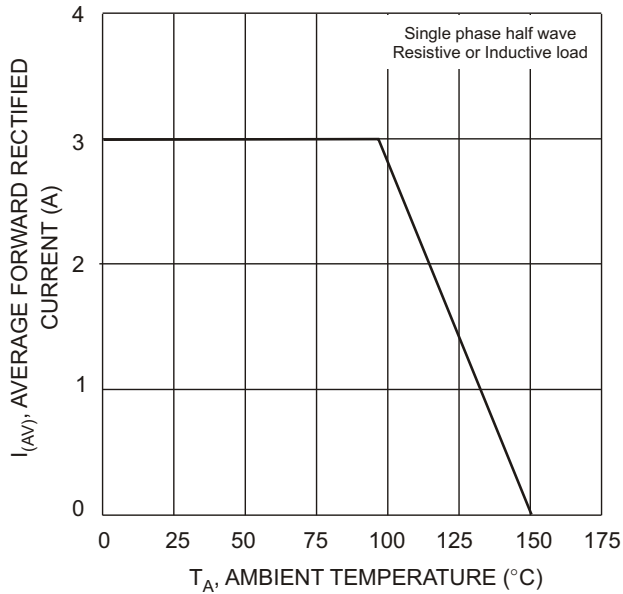

Fig. 1 Forward Derating Curve

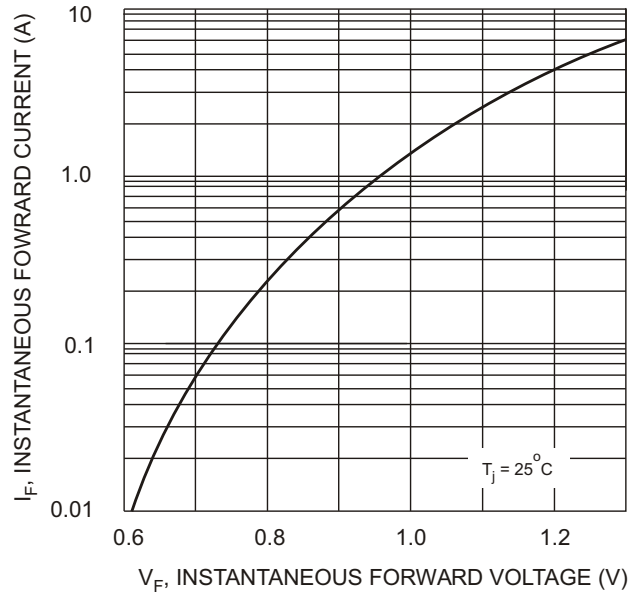

Fig. 2 Typical Forward Characteristics

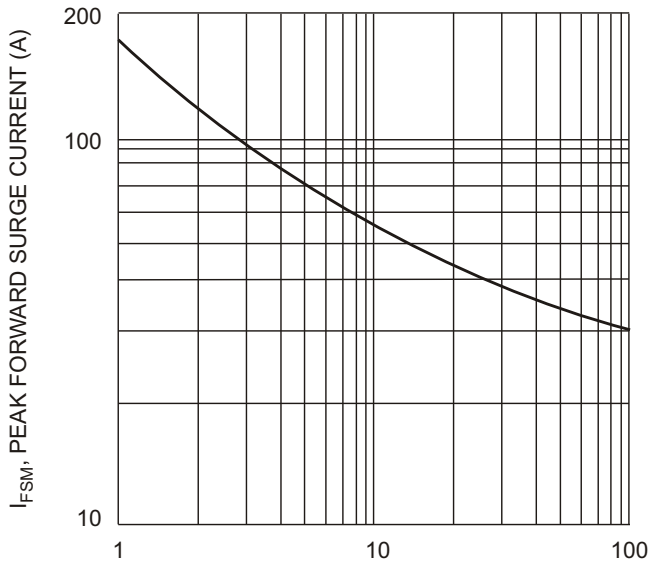

Fig. 3 Peak Forward Surge Current

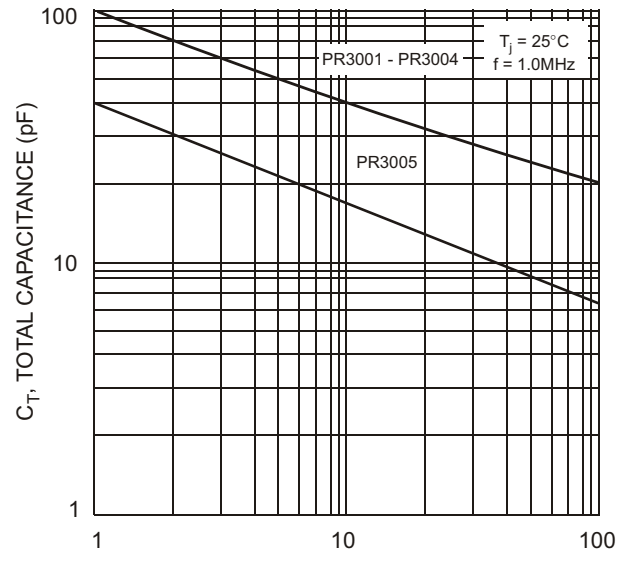
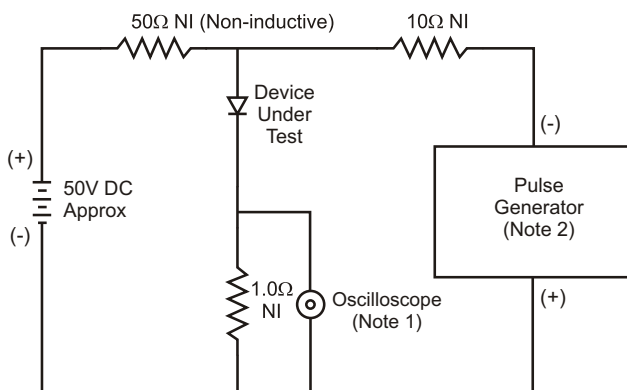
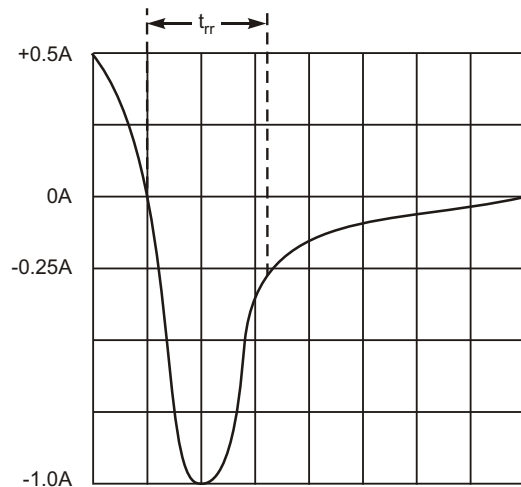

Fig. 4 Typical Total Capacitance



- Notes:
1. Rise Time = 7.0ns max. Input Impedance = 1.0MΩ, 22pF.
 2. Rise Time = 10ns max. Input Impedance = 50Ω.



Set time base for 50/100 ns/cm

Fig. 5 Reverse Recovery Time Characteristic and Test Circuit

Ordering Information (Note 6)

Device	Packaging	Shipping
PR3001-B	DO-201AD	500/Bulk
PR3001-T	DO-201AD	1.2K/Tape & Reel, 13-inch
PR3002-B	DO-201AD	500/Bulk
PR3002-T	DO-201AD	1.2K/Tape & Reel, 13-inch
PR3003-B	DO-201AD	500/Bulk
PR3003-T	DO-201AD	1.2K/Tape & Reel, 13-inch
PR3004-B	DO-201AD	500/Bulk
PR3004-T	DO-201AD	1.2K/Tape & Reel, 13-inch
PR3005-B	DO-201AD	500/Bulk
PR3005-T	DO-201AD	1.2K/Tape & Reel, 13-inch

Notes: 6. For packaging details, visit our website at <http://www.diodes.com/datasheets/ap02008.pdf>.

IMPORTANT NOTICE

Diodes Incorporated and its subsidiaries reserve the right to make modifications, enhancements, improvements, corrections or other changes without further notice to any product herein. Diodes Incorporated does not assume any liability arising out of the application or use of any product described herein; neither does it convey any license under its patent rights, nor the rights of others. The user of products in such applications shall assume all risks of such use and will agree to hold Diodes Incorporated and all the companies whose products are represented on our website, harmless against all damages.

LIFE SUPPORT

Diodes Incorporated products are not authorized for use as critical components in life support devices or systems without the expressed written approval of the President of Diodes Incorporated.

Looking for pricing, stock, or lifecycle information?

Click below to explore more details on WIN SOURCE:

-  [View PR3001-T on WIN SOURCE](#)
-  [Diodes Incorporated Information](#)

Optimize Your Supply Chain with WIN SOURCE Solutions

-  Global Sourcing Solution
-  Obsolete Management
-  Cost Control Management
-  Shortage Management
-  Alternative Solution
-  Excess Inventory Management