



**THE DATASHEET OF
RR121-1B53-311**



1 Description

The RedRock™ RR121 Series is a magnetic sensor with digital push-pull output ideal for use in medical, industrial, automotive, and consumer applications. Based on patented Tunneling Magnetoresistance (TMR) technology with seamless CMOS integration, the RR121 offers multiple configurations of several parameters to enable applications like proximity sensing, rotary sensing, and level detection.

The RR121 features available operate sensitivities from 9 G (0.9 mT) to 70 G (7 mT), and either omnipolar, unipolar, or bipolar magnetic field response. It has the world's lowest average current drain (200 nA) for an active magnetic sensor, as well as operating frequencies up to 10 kHz and high operating temperature ranges from -40°C up to 125°C.

Device Information

Part Series	Package	Body Size (mm)
RR121	SOT-23-3	2.9 x 1.6 x 1.2
	LGA-4	1.4 x 1.4 x 0.45
	Leaded LGA-4	1.4 x 1.4 x 0.45

2 Features

- ▶ Operate sensitivity from 9 G to 70 G
- ▶ Lowest Average Current < 200 nA
- ▶ Omnipolar, Unipolar and Bipolar Latching Responses Available
- ▶ Operating Frequencies up to 10 kHz
- ▶ Temperature Rated up to 125°C
- ▶ RoHS & REACH Compliant

3 Applications

- ▶ Proximity Detection
- ▶ Rotary Sensing
- ▶ Fluid Level Detection
- ▶ Door & Lid Closure Detection
- ▶ Utility Meters
- ▶ Portable Medical Devices
- ▶ Motor Controllers
- ▶ Consumer Electronics
- ▶ Wake-Up μ Processor

Device Packages



Please note: This Product Series is approaching end of life and is NOT recommended for new designs. For new designs, please consult the [end of life announcement](#) which specifies recommended new RedRock series replacements.

Functional Block Diagram

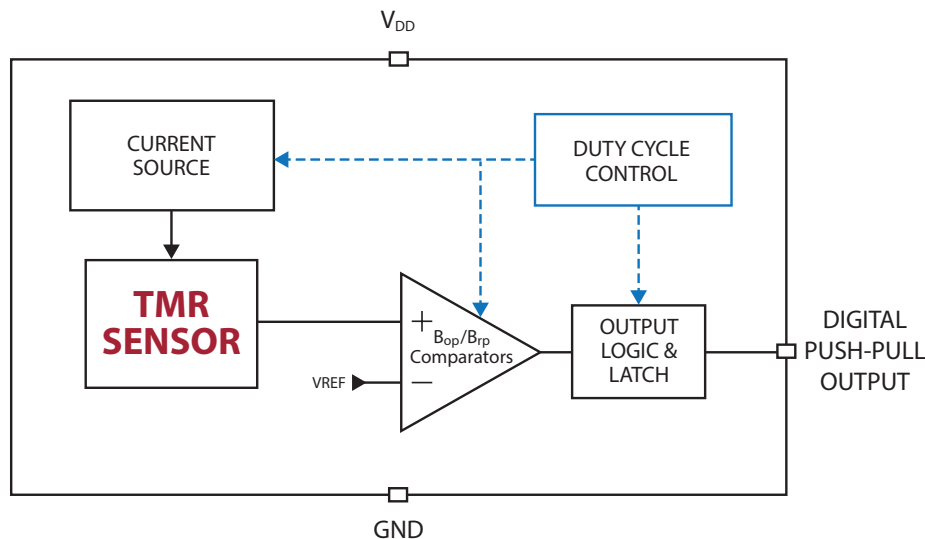

Table of Contents

1. Description 1

2. Features 1

3. Applications 1

4. Specifications for all RR121 Series Sensors 4

 4.1 Absolute Environmental Ratings for all RR121 Series Sensors 4

 4.2 Absolute Electrical Ratings for all RR121 Series Sensors 4

 4.3 Operating Electrical Characteristics for all RR121 Series Sensors 4

5. Operating Characteristics for RR121-1B13-311 and RR121-1B13-312 5

6. Operating Characteristics for RR121-1A23-311 5

7. Operating Characteristics for RR121-1F23-311 - **OBSOLETE** 6

8. Operating Characteristics for RR121-1B53-311 6

9. Operating Characteristics for RR121-1A53-311 7

10. Operating Characteristics for RR121-1E73-311 7

11. Operating Characteristics for RR121-1B93-312 7

12. Operating Characteristics for RR121-2A32-364 8

13. Operating Characteristics for RR121-3C63-311 8

14. Operating Characteristics for RR121-3C73-311 8

15. Operate & Release Lobe Plots 9

 15.1 RR121-1B13-311 9

 15.2 RR121-1B13-312 9

 15.3 RR121-1A23-311 9

 15.4 RR121-1B53-311 9

16. Graphs - Typical Electrical Characteristics 10

 16.1 RR121-1B13-311 & RR121-1B13-312 Average Supply Current vs Supply Voltage vs Temperature 10

 16.2 RR121-1B13-311 & RR121-1B13-312 Average Supply Current vs Temperature vs Supply Voltage 10

 16.3 RR121-1B13-311 & RR121-1B13-312 Sampling Frequency vs Supply Voltage vs Temperature 10

 16.4 RR121-1B13-311 & RR121-1B13-312 B_{OPN} (Blue) and B_{OPS} (Red) vs Supply Voltage at +25°C 11

 16.5 RR121-1B13-311 & RR121-1B13-312 B_{RPN} (Blue) and B_{RPS} (Red) vs Supply Voltage at +25°C 11

 16.6 RR121-1B13-311 & RR121-1B13-312 B_{OPN} (Blue) and B_{OPS} (Red) vs Operating Temperature at V_{DD}=3.0 V 11

 16.7 RR121-1B13-311 & RR121-1B13-312 B_{RPN} (Blue) and B_{RPS} (Red) vs Operating Temperature at V_{DD}=3.0 V 11

 16.8 RR121-1A23-311 Average Supply Current vs Supply Voltage vs Temperature 12

 16.9 RR121-1A23-311 Average Supply Current vs Temperature vs Supply Voltage 12

 16.10 RR121-1A23-311 Sampling Frequency vs Supply Voltage vs Temperature 12

 16.11 RR121-1A23-311 B_{OPN} (Blue) and B_{OPS} (Red) vs Supply Voltage at +25°C 13

 16.12 RR121-1A23-311 B_{RPN} (Blue) and B_{RPS} (Red) vs Supply Voltage at +25°C 13

 16.13 RR121-1A23-311 B_{OPN} (Blue) and B_{OPS} (Red) vs Operating Temperature at V_{DD}=3.0 V 13

 16.14 RR121-1A23-311 B_{RPN} (Blue) and B_{RPS} (Red) vs Operating Temperature at V_{DD}=3.0 V 13

 16.15 RR121-1B53-311 & RR121-1A53-311 Average Supply Current vs Supply Voltage vs Temperature 14

 16.16 RR121-1B53-311 & RR121-1A53-311 Average Supply Current vs Temperature vs Supply Voltage 14

 16.17 RR121-1B53-311 & RR121-1A53-311 Sampling Frequency vs Supply Voltage vs Temperature 14

 16.18 RR121-1B53-311 B_{OPN} (Blue) and B_{OPS} (Red) vs Supply Voltage at +25°C 15

 16.19 RR121-1B53-311 B_{RPN} (Blue) and B_{RPS} (Red) vs Supply Voltage at +25°C 15

 16.20 RR121-1B53-311 B_{OPN} (Blue) and B_{OPS} (Red) vs Operating Temperature at V_{DD}=3.0 V 15

 16.21 RR121-1B53-311 B_{RPN} (Blue) and B_{RPS} (Red) vs Operating Temperature at V_{DD}=3.0 V 15

 16.22 RR121-3C63-311 Average Supply Current vs Supply Voltage vs Temperature 16

 16.23 RR121-3C63-311 Average Supply Current vs Temperature vs Supply Voltage 16

16.24	RR121-3C63-311 Sampling Frequency vs Supply Voltage vs Temperature	16
16.25	RR121-1E73-311 & RR121-3C73-311 Average Supply Current vs Supply Voltage vs Temperature	17
16.26	RR121-1E73-311 & RR121-3C73-311 Average Supply Current vs Temperature vs Supply Voltage	17
16.27	RR121-1E73-311 & RR121-3C73-311 Sampling Frequency vs Supply Voltage vs Temperature	17
16.28	RR121-1B93-312 & RR121-3C73-311 Sampling Frequency vs Supply Voltage vs Temperature	17
16.29	RR121-1B93-312 B _{OPN} (Blue) and B _{OPS} (Red) vs Supply Voltage at +25°C	18
16.30	RR121-1B93-312 B _{RPN} (Blue) and B _{RPS} (Red) vs Supply Voltage at +25°C	18
16.31	RR121-1B93-312 B _{OPN} (Blue) and B _{OPS} (Red) vs Operating Temperature at V _{DD} =3.0 V	18
16.32	RR121-1B93-312 B _{RPN} (Blue) and B _{RPS} (Red) vs Operating Temperature at V _{DD} =3.0 V	18
16.33	RR121-1B93-312 Average Supply Current vs Supply Voltage vs Temperature	19
16.34	RR121-1B93-312 Average Supply Current vs Temperature vs Supply Voltage	19
17.	Application Information	20
17.1	Application Circuit (SOT-23-3)	20
17.2	Application Circuit (LGA-4)	20
17.3	Application Circuit (Leaded LGA-4)	20
18.	Part Selection & Ordering Information	21
18.1	Part Selection Table	21
18.2	Device Nomenclature Ordering Information	21
19.	Axis of Sensitivity	21
20.	Dimensions	22
20.1	LGA-4 Package Dimensions	22
20.2	SOT-23-3 Package Dimensions	22
20.3	Leaded LGA-4 Package Dimensions	22
21.	TMR Sensor Location	23
21.1	LGA Package	23
21.2	SOT Package	23
21.3	Leaded LGA Package	23
21.4	SOT Package - Side View	23
21.5	LGA & Leaded LGA Package - Side View	23
22.	Magnetic Flux Response Diagrams	24
22.1	Omnipolar Magnetic Flux Response (Active Low Option)	24
22.2	Bipolar Magnetic Flux Response (Active Low Option)	24
22.3	Unipolar Magnetic Flux Response (Dual Active Low Option)	24
23.	Output Behavior vs. Magnetic Field Diagrams	25
23.1	Output Behavior vs. Magnetic Field - Omnipolar	25
23.2	Output Behavior vs. Magnetic Field - Bipolar	25
23.3	Output Behavior vs. Magnetic Field - Unipolar (Dual Output)	25
24.	TMR Sensor & Switch Packaging	26
24.1	SOT-23-3 Tape & Reel Packaging	26
24.2	LGA-4 & Leaded LGA-4 Tape & Reel Packaging	27
24.3	RedRock TMR Packaging	28
25.	Suggested Pb-Free Reflow Profile	28
26.	Suggested Solder Pad Layout	29
26.1	SOT-23-3 Solder Pad Layout	29
26.2	LGA-4 Solder Pad Layout	29
26.3	Leaded LGA-4 Solder Pad Layout	29

4 Specifications for all RR121 Series Sensors

4.1 Absolute Environmental Ratings for all RR121 Series Sensors¹

Parameters	Units	Min	Typ	Max
Operating Temperature (T_{OP})	°C	-40		+125
Storage Temperature (T_{STG})	°C	-65		+150
Junction Temperature (T_J)	°C			+150
Soldering Temperature (3 cycles, 1 min.) (T_{SOL})	°C			+260
ESD Level Human Body Model per JESD22-A114	V	±4000		
Magnetic Field Exposure	G			2000

4.2 Absolute Electrical Ratings for all RR121 Series Sensors¹

Parameters	Units	Min	Typ	Max
Supply Voltage (V_{DD})	V	-0.3		+4.0
Push-pull Output (Active Low)(V_{OUT_PP})	V	-0.3		V_{DD}
Input and Output Current (I_{IN}/I_{OUT})	mA	-10		+10

4.3 Operating Electrical Characteristics for all RR121 Series Sensors²

Parameters	Units	Min	Typ	Max
Supply Voltage (V_{DD})	V	+2.7	+3.0	+3.6
Output Voltage (High) ³ (V_{OUTH})	V	90% V_{DD}		
Output Voltage (Low) ³ (V_{OUTL})	V			10% V_{DD}
Power-On Time (t_{ON})($V_{DD} > 2.7V$)	μs		500	
Under-Voltage Lockout Threshold Rising V_{DD} (V_{UVLO_RISE})	V		+2.20	+2.60
Under-Voltage Lockout Threshold Falling V_{DD} (V_{UVLO_FALL})	V	+1.90	+2.15	
Under-Voltage Lockout Hysteresis (V_{UV_HYST})	mV		+50	

Notes:

- Exceeding Absolute Ratings may cause permanent damage to the device. Exposure at the maximum rated conditions for extended periods of time may also affect device reliability.
- Unless otherwise specified, all characteristics are measured at 25°C.
- See "Magnetic Field vs. Output Status" for more details.



ESD Note: This product uses semiconductors that can be damaged by electrostatic discharge (ESD). When handling, proper ESD precautions should be taken to avoid performance degradation or loss of functionality. Damage due to inappropriate handling is not covered under warranty.

5 Operating Characteristics for RR121-1B13-311 and RR121-1B13-312¹

Parameters	Units	Min	Typ	Max
Average Supply Current ($I_{DD(AVG)}$) ²	nA		200	700
Switching Frequency (f_{SW})	Hz	1	2	4
Active Mode Time (t_{ACT})	μ s		1.4	
Idle Mode Time (t_{IDLE})	ms		500	
Operate Point (B_{OPN})	G	27	30	38
Operate Point (B_{OPS})	G	-38	-30	-27
Release Point (B_{RPN})	G	18	20	27
Release Point (B_{RPS})	G	-27	-20	-18
Hysteresis (B_{HYST}) ³	G	5	10	

Notes:

1. Unless otherwise specified, $V_{DD} = 2.7$ V to 3.6 V, $T_A = -40^\circ$ C to $+125^\circ$ C. Typical values are $V_{DD} = 3.0$ V and $T_A = +25^\circ$ C.
2. Conditions: $t = 10$ seconds
3. Conditions: $B_{HYST} = |B_{OP} - B_{RP}|$

6 Operating Characteristics for RR121-1A23-311¹

Parameters	Units	Min	Typ	Max
Average Supply Current ($I_{DD(AVG)}$) ²	nA		230	700
Switching Frequency (f_{SW})	Hz	7	10	13
Active Mode Time (t_{ACT})	μ s		1.4	
Idle Mode Time (t_{IDLE})	ms		100	
Operate Point (B_{OPN})	G	8	9	12
Operate Point (B_{OPS})	G	-12	-9	-8
Release Point (B_{RPN})	G	3	5	7
Release Point (B_{RPS})	G	-7	-5	-3
Hysteresis (B_{HYST}) ³	G	3	4	

Notes:

1. Unless otherwise specified, $V_{DD} = 2.7$ V to 3.6 V, $T_A = -40^\circ$ C to $+125^\circ$ C. Typical values are $V_{DD} = 3.0$ V and $T_A = +25^\circ$ C.
2. Conditions: $t = 10$ seconds
3. Conditions: $B_{HYST} = |B_{OP} - B_{RP}|$

7 Operating Characteristics for RR121-1F23-311¹

Parameters	Units	Min	Typ	Max
Average Supply Current ($I_{DD(AVG)}$) ²	nA		230	700
Switching Frequency (f_{SW})	Hz	7	10	13
Active Mode Time (t_{ACT})	μ s		1.1	
Idle Mode Time (t_{IDLE})	ms	77		143
Operate Point (B_{OPN})	G		70	
Operate Point (B_{OPS})	G		-70	
Release Point (B_{RPN})	G		50	
Release Point (B_{RPS})	G		-50	
Hysteresis (B_{HYST}) ³	G		20	

Notes:

1. Unless otherwise specified, $V_{DD} = 2.7$ V to 3.6 V, $T_A = -40^\circ$ C to $+125^\circ$ C. Typical values are $V_{DD} = 3.0$ V and $T_A = +25^\circ$ C.
2. Conditions: $t = 10$ seconds
3. Conditions: $B_{HYST} = |B_{OP} - B_{RP}|$

8 Operating Characteristics for RR121-1B53-311¹

Parameters	Units	Min	Typ	Max
Average Supply Current ($I_{DD(AVG)}$) ²	μ A		1.4	2.5
Switching Frequency (f_{SW})	Hz	165	250	300
Active Mode Time (t_{ACT})	μ s		1.4	
Idle Mode Time (t_{IDLE})	ms		4.0	
Operate Point (B_{OPN})	G	27	30	38
Operate Point (B_{OPS})	G	-38	-30	-27
Release Point (B_{RPN})	G	18	20	27
Release Point (B_{RPS})	G	-27	-20	-18
Hysteresis (B_{HYST}) ³	G	5	10	

Notes:

1. Unless otherwise specified, $V_{DD} = 2.7$ V to 3.6 V, $T_A = -40^\circ$ C to $+125^\circ$ C. Typical values are $V_{DD} = 3.0$ V and $T_A = +25^\circ$ C.
2. Conditions: $t = 10$ seconds
3. Conditions: $B_{HYST} = |B_{OP} - B_{RP}|$

9 Operating Characteristics for RR121-1A53-311¹

Parameters	Units	Min	Typ	Max
Average Supply Current ($I_{DD(AVG)}$) ²	μA		1.2	2.5
Switching Frequency (f_{SW})	Hz	165	250	300
Active Mode Time (t_{ACT})	μs		1.4	
Idle Mode Time (t_{IDLE})	ms	3.3	4.0	6.0
Operate Point (B_{OPN})	G	8	9	12
Operate Point (B_{OPS})	G	-12	-9	-8
Release Point (B_{RPN})	G	3	5	7
Release Point (B_{RPS})	G	-7	-5	-3
Hysteresis (B_{HYST}) ³	G	3	4	

10 Operating Characteristics for RR121-1E73-311¹

Parameters	Units	Min	Typ	Max
Average Supply Current ($I_{DD(AVG)}$) ²	μA		8	13
Switching Frequency (f_{SW})	kHz	1.63	2.50	3.25
Active Mode Time (t_{ACT})	μs		1.4	
Idle Mode Time (t_{IDLE})	μs	308	400	614
Operate Point (B_{OPN})	G	13	15	18
Operate Point (B_{OPS})	G	-18	-15	-13
Release Point (B_{RPN})	G	8	10	13
Release Point (B_{RPS})	G	-13	-10	-8
Hysteresis (B_{HYST}) ³	G	3	5	

11 Operating Characteristics for RR121-1B93-312¹

Parameters	Units	Min	Typ	Max
Average Supply Current ($I_{DD(AVG)}$) ²	μA		36	
Switching Frequency (f_{SW})	kHz	7	10	13
Active Mode Time (t_{ACT})	μs		1.4	
Idle Mode Time (t_{IDLE})	μs	77	100	143
Operate Point (B_{OPN})	G	27	30	38
Operate Point (B_{OPS})	G	-38	-30	-27
Release Point (B_{RPN})	G	18	20	27
Release Point (B_{RPS})	G	-27	-20	-18
Hysteresis (B_{HYST}) ³	G	5	10	

Notes:

1. Unless otherwise specified, $V_{DD} = 2.7\text{ V to }3.6\text{ V}$, $T_A = -40^\circ\text{C to }+125^\circ\text{C}$. Typical values are $V_{DD} = 3.0\text{ V}$ and $T_A = +25^\circ\text{C}$.
2. Conditions: $t = 10\text{ seconds}$
3. Conditions: $B_{HYST} = |B_{OP} - B_{RP}|$

12 Operating Characteristics for RR121-2A32-364¹

Parameters	Units	Min	Typ	Max
Average Supply Current ($I_{DD(AVG)}$) ²	nA		280	700
Switching Frequency (f_{SW})	Hz	12	20	28
Active Mode Time (t_{ACT})	μ s		1.4	
Idle Mode Time (t_{IDLE})	ms	36	50	83
Operate Point (B_{OPN})	G	8	9	12
Operate Point (B_{OPS})	G	-12	-9	-8
Release Point (B_{RPN})	G	3	5	7
Release Point (B_{RPS})	G	-7	-5	-3
Hysteresis (B_{HYST}) ³	G	3	4	

13 Operating Characteristics for RR121-3C63-311¹

Parameters	Units	Min	Typ	Max
Average Supply Current ($I_{DD(AVG)}$) ²	μ A		1.7	3.3
Switching Frequency (f_{SW})	Hz	325	500	600
Active Mode Time (t_{ACT})	μ s		1.4	
Idle Mode Time (t_{IDLE})	ms		2.0	
Operate Point (B_{OPS})	G	-14	-10	-8
Release Point (B_{RPN})	G	8	10	14

14 Operating Characteristics for RR121-3C73-311¹

Parameters	Units	Min	Typ	Max
Average Supply Current ($I_{DD(AVG)}$) ²	μ A		8	13
Switching Frequency (f_{SW})	kHz	1.63	2.50	3.25
Active Mode Time (t_{ACT})	μ s		1.4	
Idle Mode Time (t_{IDLE})	μ s	308	400	614
Operate Point (B_{OPS})	G	-14	-10	-8
Release Point (B_{RPN})	G	8	10	14

Notes:

1. Unless otherwise specified, $V_{DD} = 2.7$ V to 3.6 V, $T_A = -40^\circ\text{C}$ to $+125^\circ\text{C}$. Typical values are $V_{DD} = 3.0$ V and $T_A = +25^\circ\text{C}$.
2. Conditions: $t = 10$ seconds
3. Conditions: $B_{HYST} = |B_{OP} - B_{RP}|$

15 Operate & Release Lobe Plots

Operate and release distances show are relative. The actual operate and release distances will depend on the type of magnet that is used.

15.1 RR121-1B13-311

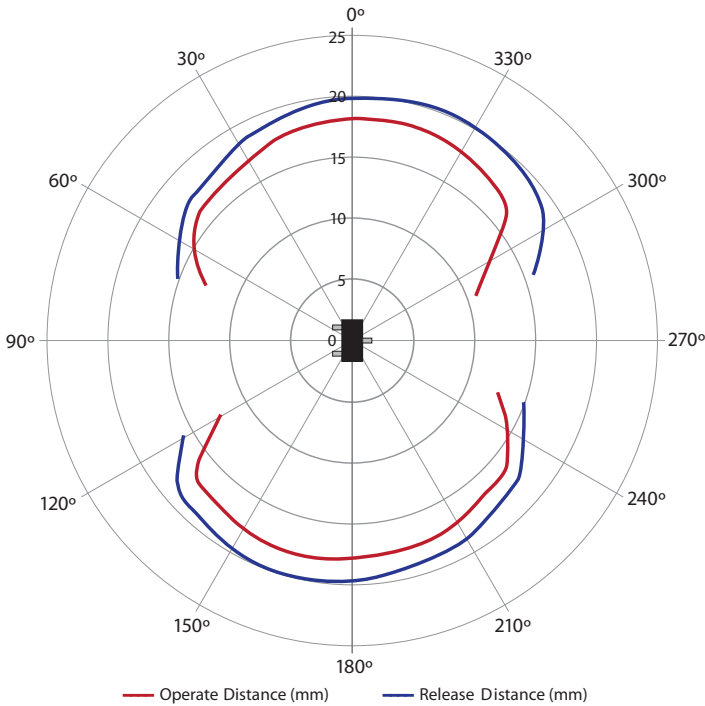

15.2 RR121-1B13-312

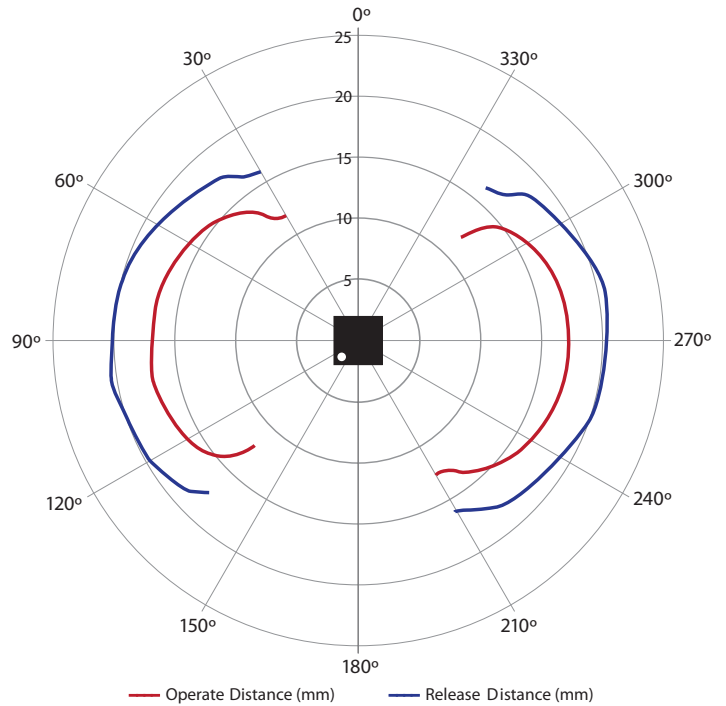

15.3 RR121-1A23-311

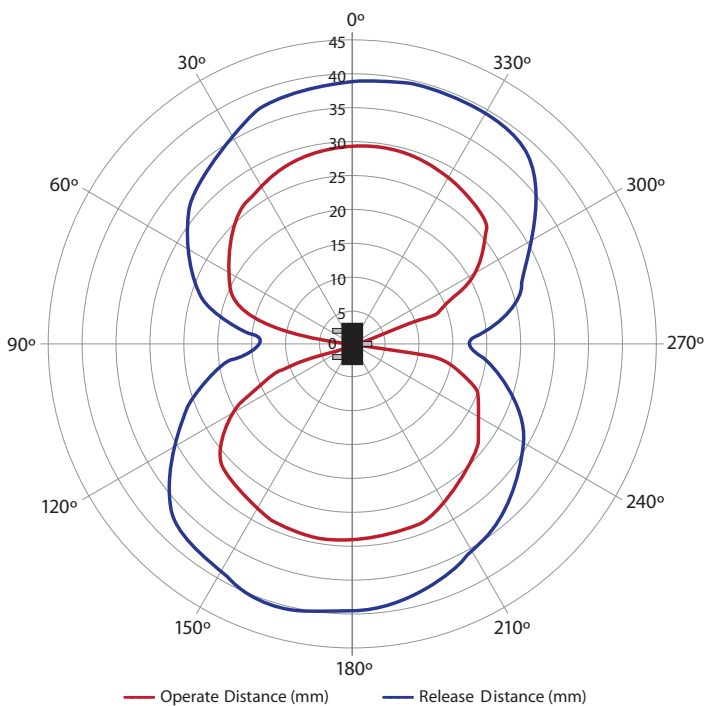

15.4 RR121-1B53-311

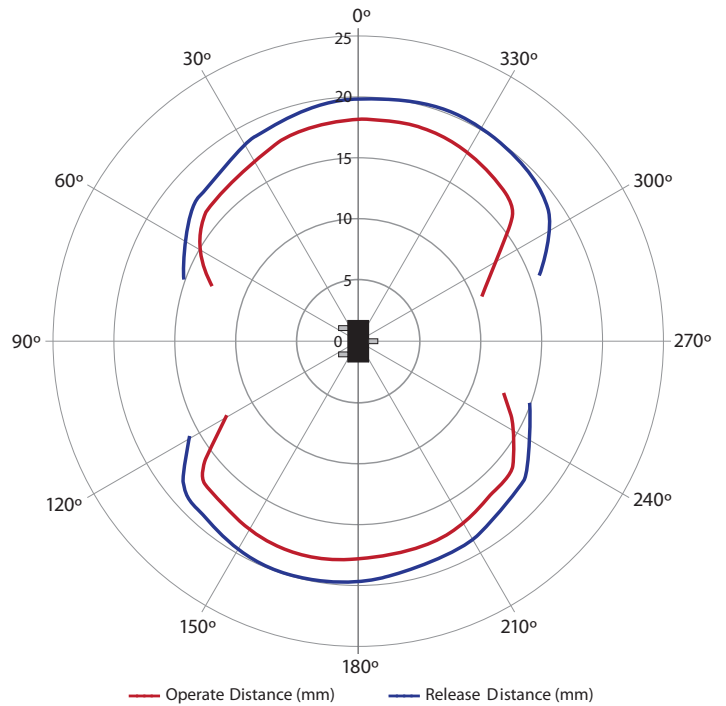

16 Graphs - Typical Electrical Characteristics

$V_{DD} = 3.0\text{ V}$ and $T_A = +25\text{ }^\circ\text{C}$, $C_{DD} = 1.0\text{ }\mu\text{F}$ (unless otherwise specified)

**16.1 RR121-1B13-311 and RR121-1B13-312
Average Supply Current vs.
Supply Voltage vs. Temperature**

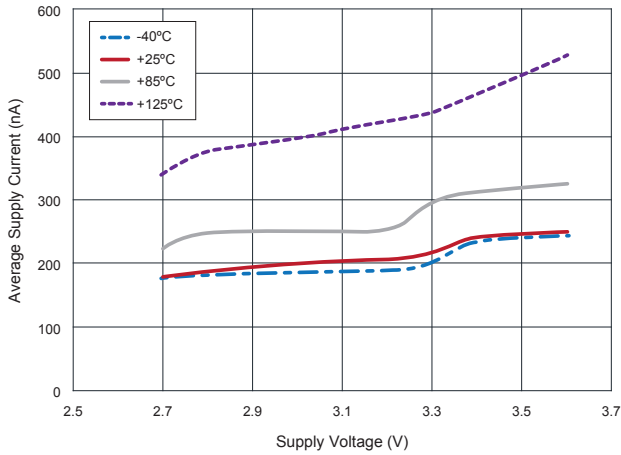

**16.2 RR121-1B13-311 and RR121-1B13-312
Average Supply Current vs.
Temperature vs. Supply Voltage**

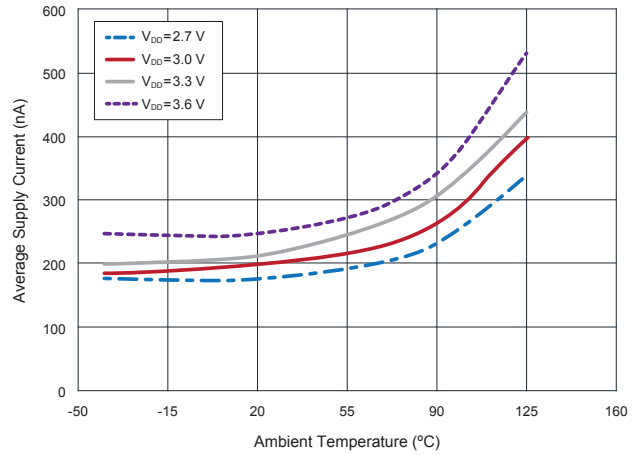

**16.3 RR121-1B13-311 and RR121-1B13-312
Sampling Frequency vs.
Supply Voltage vs. Temperature**

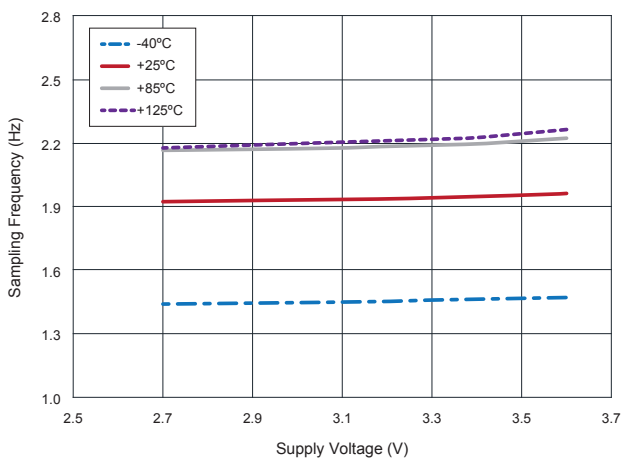

16 Graphs - Typical Magnetic Characteristics

$V_{DD} = 3.0\text{ V}$ and $T_A = +25\text{ }^\circ\text{C}$, $C_{DD} = 1.0\text{ }\mu\text{F}$ (unless otherwise specified)

16.4 RR121-1B13-311 and RR121-1B13-312
 B_{OPN} (Blue) and B_{OPS} (Red) vs.
 Supply Voltage at $+25^\circ\text{C}$

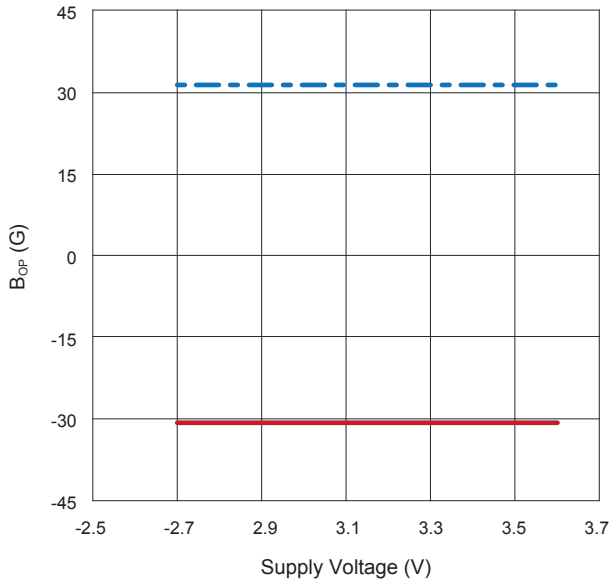

16.5 RR121-1B13-311 and RR121-1B13-312
 B_{RPN} (Blue) and B_{RPS} (Red) vs.
 Supply Voltage at $+25^\circ\text{C}$

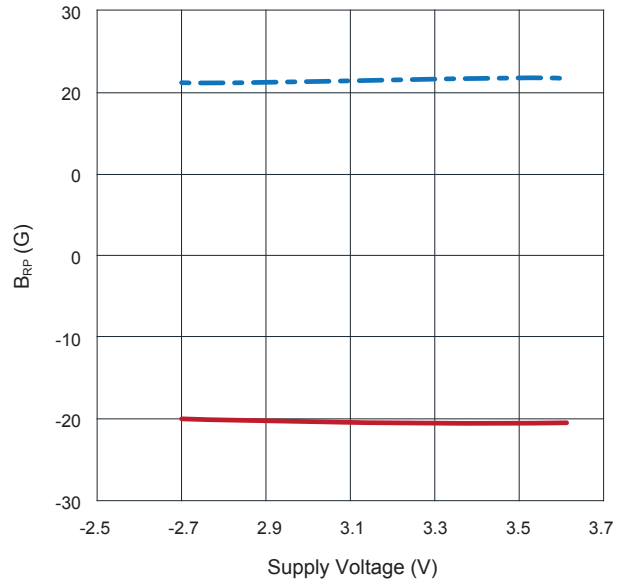

16.6 RR121-1B13-311 and RR121-1B13-312
 B_{OPN} (Blue) and B_{OPS} (Red) vs.
 Operating Temperature at $V_{DD}=3.0\text{ V}$

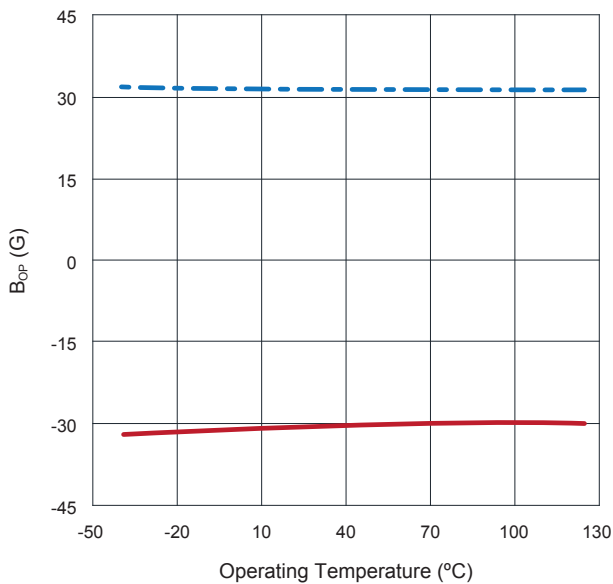

16.7 RR121-1B13-311 and RR121-1B13-312
 B_{RPN} (Blue) and B_{RPS} (Red) vs.
 Operating Temperature at $V_{DD}=3.0\text{ V}$

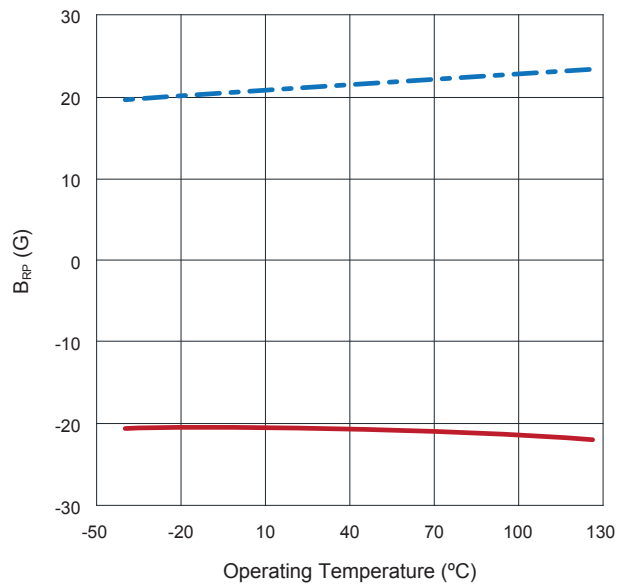

16 Graphs - Typical Characteristics

$V_{DD} = 3.0\text{ V}$ and $T_A = +25\text{ }^\circ\text{C}$, $C_{DD} = 1.0\text{ }\mu\text{F}$ (unless otherwise specified)

16.8 RR121-1A23-311
Average Supply Current vs. Supply Voltage vs. Temperature

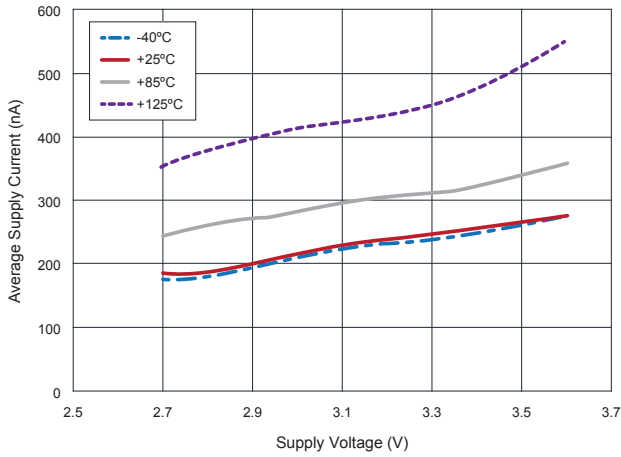

16.9 RR121-1A23-311
Average Supply Current vs. Temperature vs. Supply Voltage

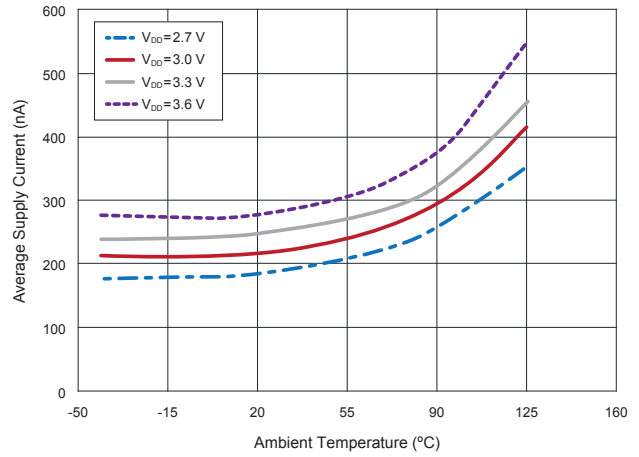

16.10 RR121-1A23-311
Sampling Frequency vs. Supply Voltage vs. Temperature

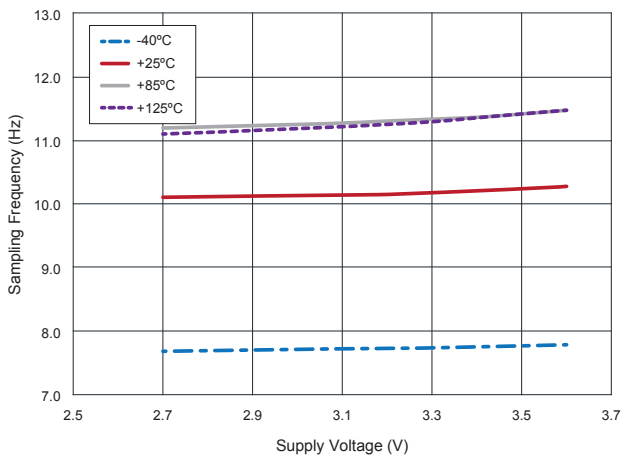

16 Graphs - Typical Magnetic Characteristics

$V_{DD} = 3.0\text{ V}$ and $T_A = +25\text{ }^\circ\text{C}$, $C_{DD} = 1.0\text{ }\mu\text{F}$ (unless otherwise specified)

16.11 RR121-1A23-311
 B_{OPN} (Blue) and B_{OPS} (Red) vs.
 Supply Voltage at $+25^\circ\text{C}$

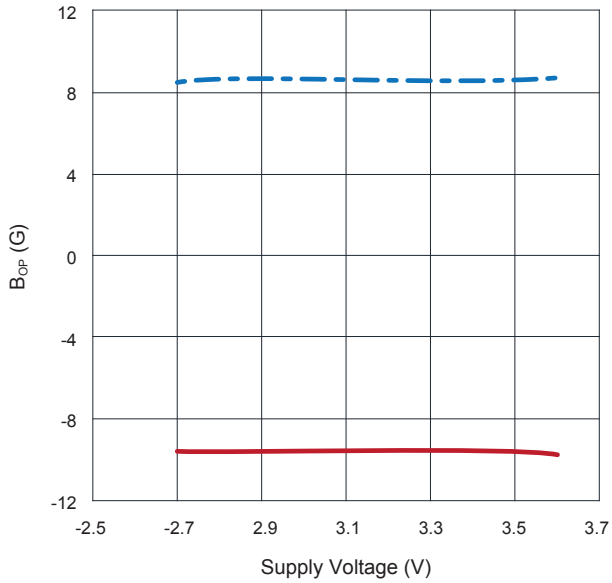

16.12 RR121-1A23-311
 B_{RPN} (Blue) and B_{RPS} (Red) vs.
 Supply Voltage at $+25^\circ\text{C}$

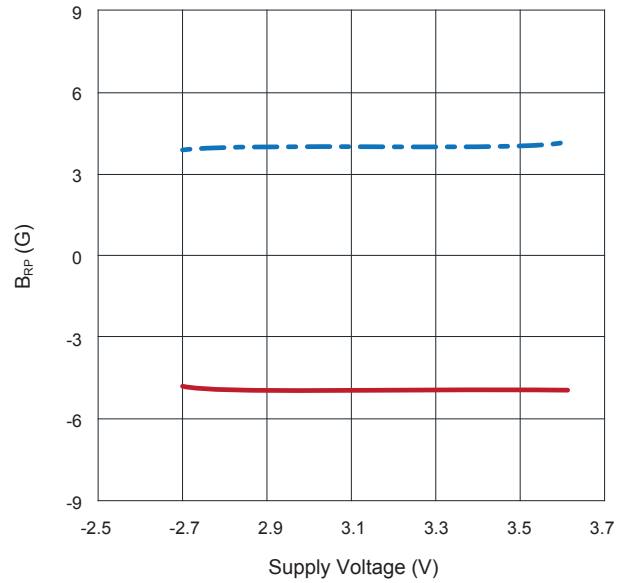

16.13 RR121-1A23-311
 B_{OPN} (Blue) and B_{OPS} (Red) vs.
 Operating Temperature at $V_{DD}=3.0\text{ V}$

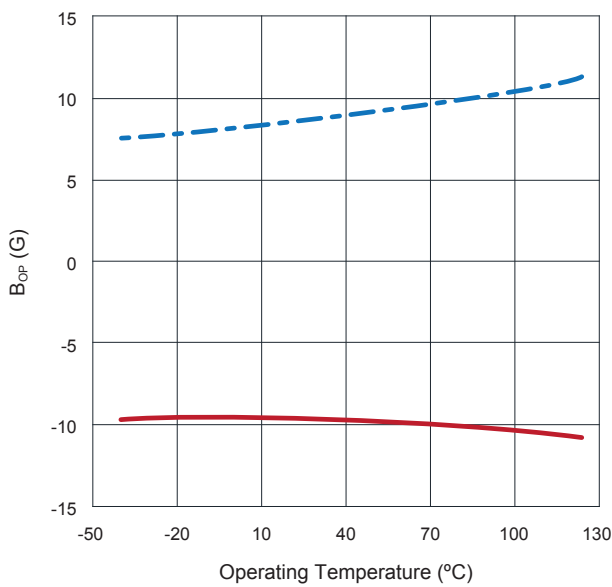

16.14 RR121-1A23-311
 B_{RPN} (Blue) and B_{RPS} (Red) vs.
 Operating Temperature at $V_{DD}=3.0\text{ V}$

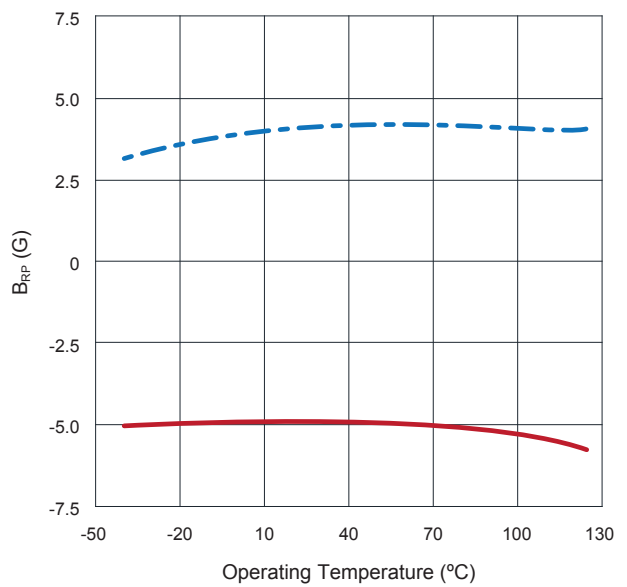

16 Graphs - Typical Characteristics

$V_{DD} = 3.0\text{ V}$ and $T_A = +25\text{ }^\circ\text{C}$, $C_{DD} = 1.0\text{ }\mu\text{F}$ (unless otherwise specified)

**16.15 RR121-1B53-311 and RR121-1A53-311
Average Supply Current vs.
Supply Voltage vs. Temperature**

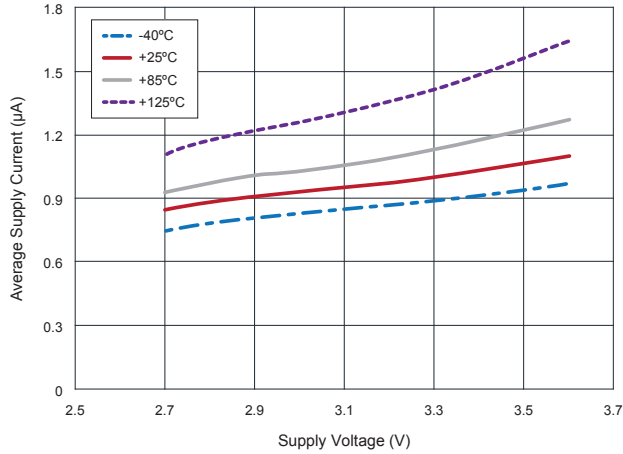

**16.16 RR121-1B53-311 and RR121-1A53-311
Average Supply Current vs.
Temperature vs. Supply Voltage**

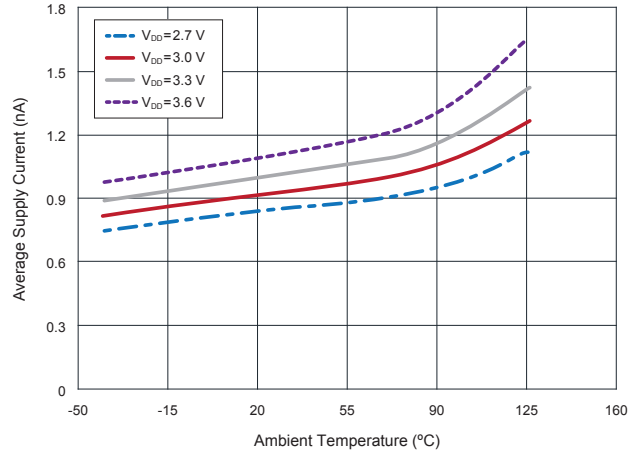

**16.17 RR121-1B53-311 and RR121-1A53-311
Sampling Frequency vs.
Supply Voltage vs. Temperature**

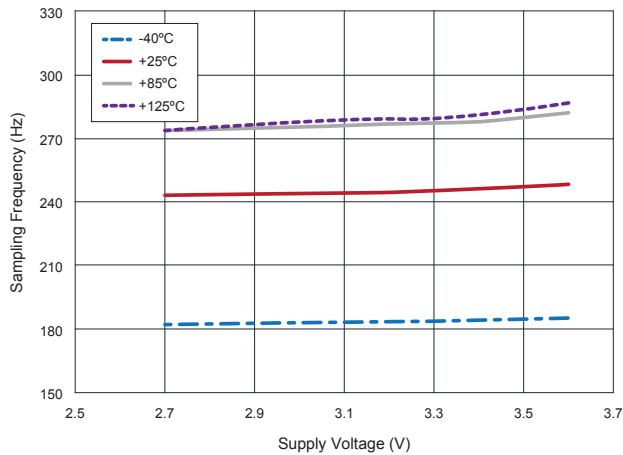

16 Graphs - Typical Magnetic Characteristics

$V_{DD} = 3.0\text{ V}$ and $T_A = +25\text{ }^\circ\text{C}$, $C_{DD} = 1.0\text{ }\mu\text{F}$ (unless otherwise specified)

16.18 RR121-1B53-311
 B_{OPN} (Blue) and B_{OPS} (Red) vs.
Supply Voltage at $+25^\circ\text{C}$

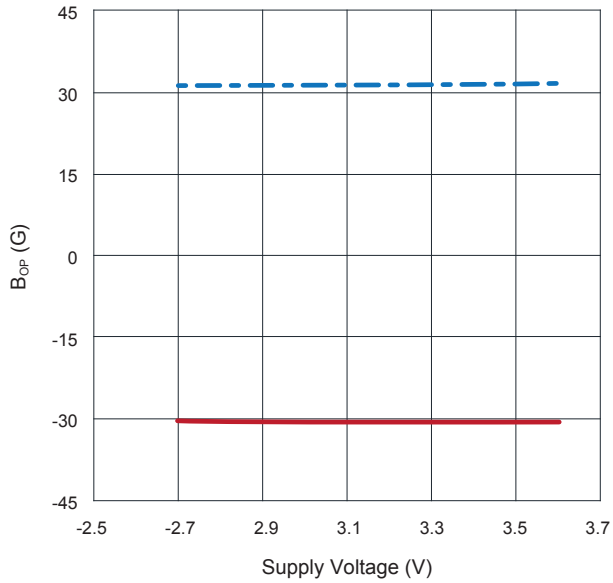

16.19 RR121-1B53-311
 B_{RPN} (Blue) and B_{RPS} (Red) vs.
Supply Voltage at $+25^\circ\text{C}$

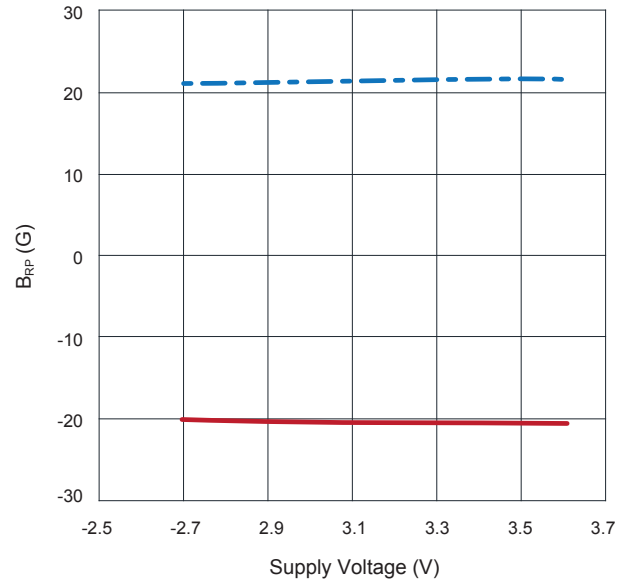

16.20 RR121-1B53-311
 B_{OPN} (Blue) and B_{OPS} (Red) vs.
Operating Temperature at $V_{DD}=3.0\text{ V}$

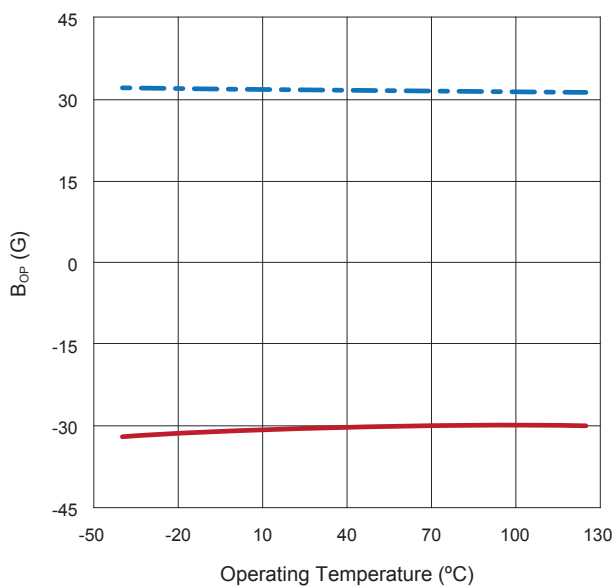

16.21 RR121-1B53-311
 B_{RPN} (Blue) and B_{RPS} (Red) vs.
Operating Temperature at $V_{DD}=3.0\text{ V}$

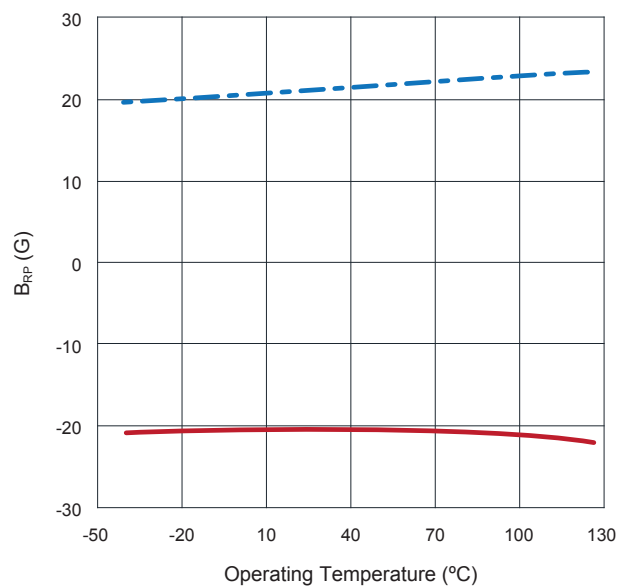

16 Graphs - Typical Characteristics

$V_{DD} = 3.0\text{ V}$ and $T_A = +25\text{ }^\circ\text{C}$, $C_{DD} = 1.0\text{ }\mu\text{F}$ (unless otherwise specified)

16.22 RR121-3C63-311
Average Supply Current vs. Supply Voltage vs. Temperature

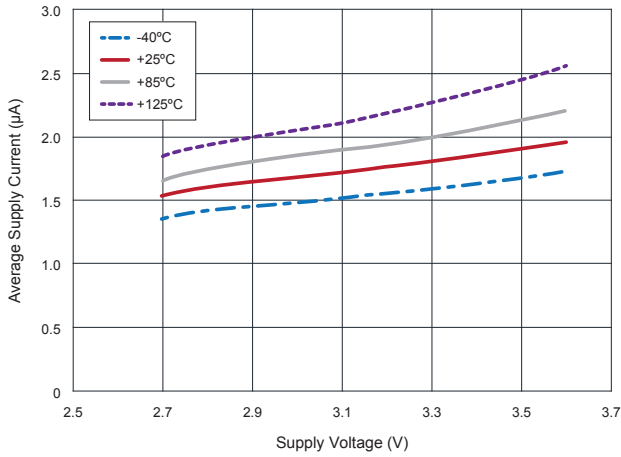

16.23 RR121-3C63-311
Average Supply Current vs. Temperature vs. Supply Voltage

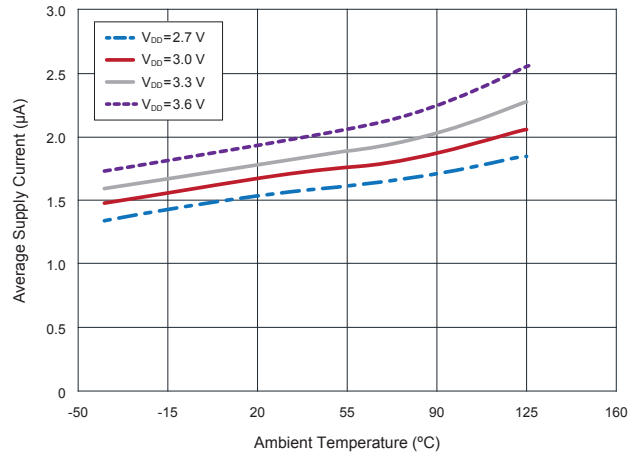

16.24 RR121-3C63-311
Sampling Frequency vs. Supply Voltage vs. Temperature

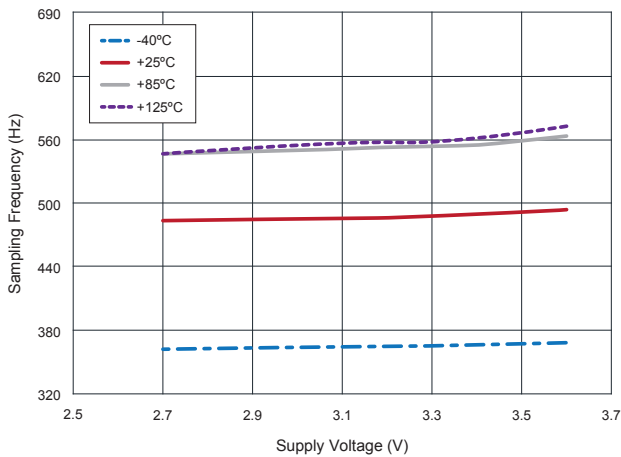

16 Graphs - Typical Characteristics

$V_{DD} = 3.0\text{ V}$ and $T_A = +25\text{ }^\circ\text{C}$, $C_{DD} = 1.0\text{ }\mu\text{F}$ (unless otherwise specified)

16.25 RR121-1E73-311 and RR121-3C73-311
Average Supply Current vs. Supply Voltage vs. Temperature

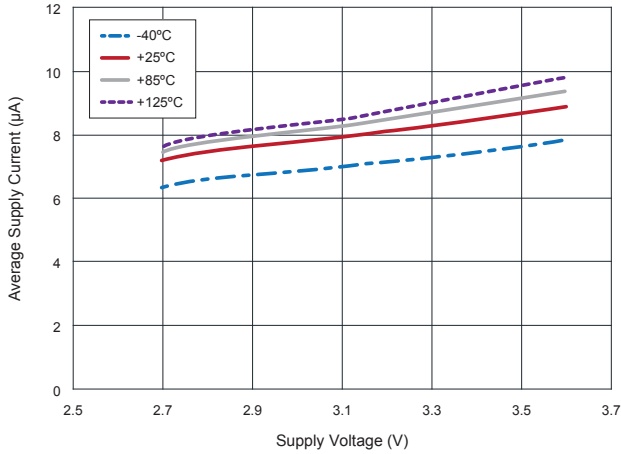

16.26 RR121-1E73-311 and RR121-3C73-311
Average Supply Current vs. Temperature vs. Supply Voltage

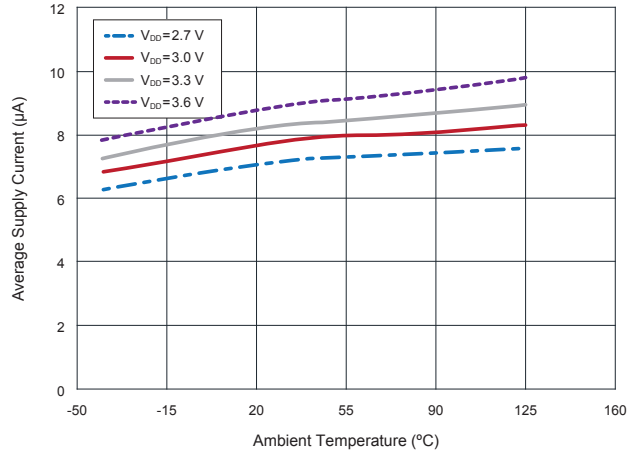

16.27 RR121-1E73-311 and RR121-3C73-311
Sampling Frequency vs. Supply Voltage vs. Temperature

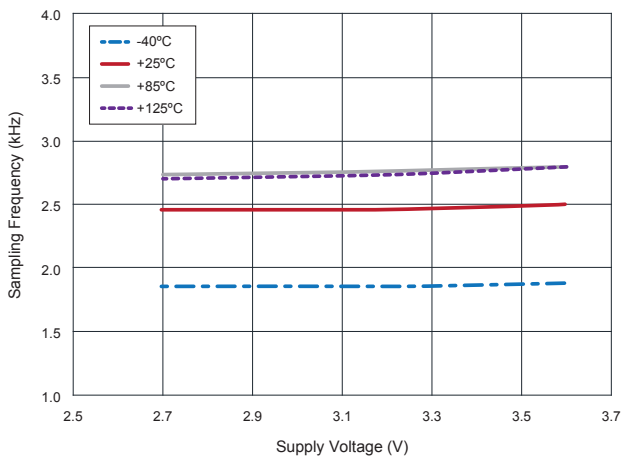

16.28 RR121-1B93-312
Sampling Frequency vs. Supply Voltage vs. Temperature

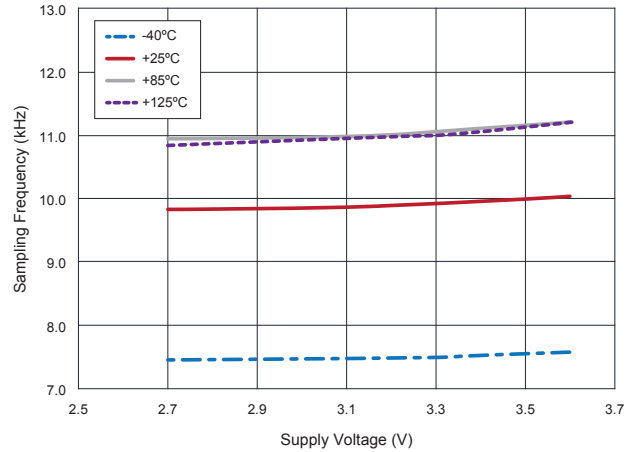

16 Graphs - Typical Magnetic Characteristics

$V_{DD} = 3.0\text{ V}$ and $T_A = +25\text{ }^\circ\text{C}$, $C_{DD} = 1.0\text{ }\mu\text{F}$ (unless otherwise specified)

16.29 RR121-1B93-312
 B_{OPN} (Blue) and B_{OPS} (Red) vs.
Supply Voltage at $+25^\circ\text{C}$

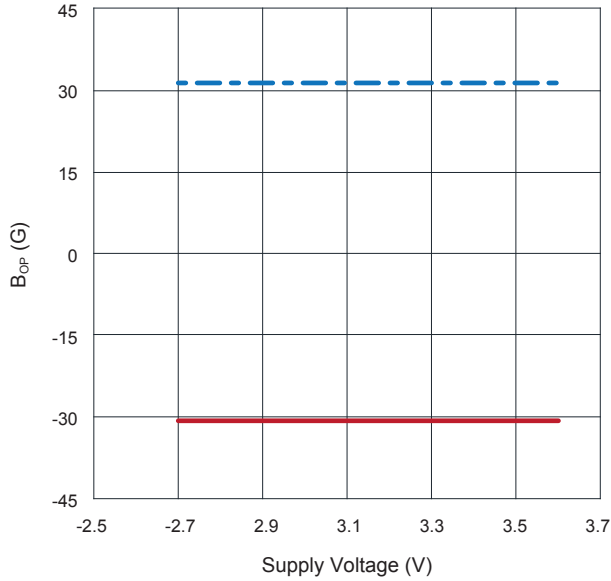

16.30 RR121-1B93-312
 B_{RPN} (Blue) and B_{RPS} (Red) vs.
Supply Voltage at $+25^\circ\text{C}$

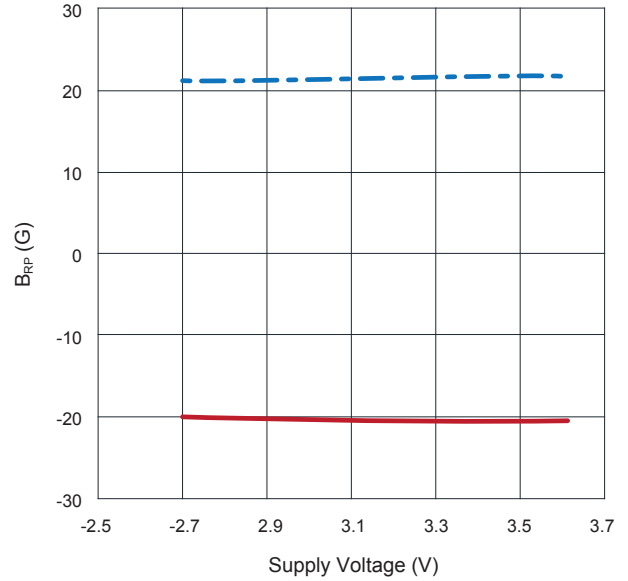

16.31 RR121-1B93-312
 B_{OPN} (Blue) and B_{OPS} (Red) vs.
Operating Temperature at $V_{DD}=3.0\text{ V}$

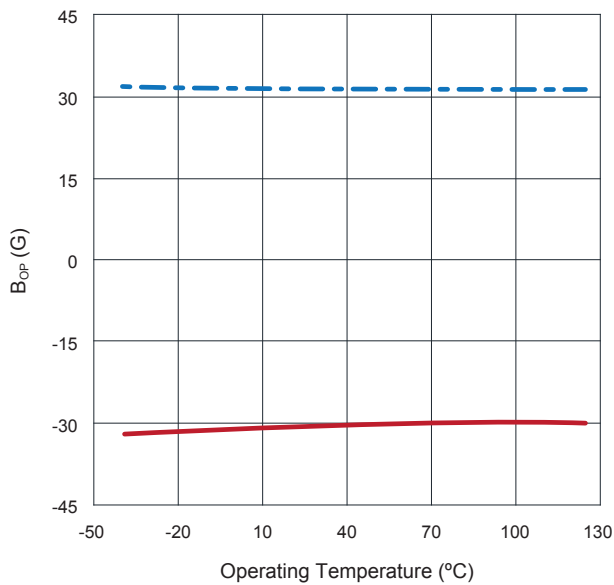

16.32 RR121-1B93-312
 B_{RPN} (Blue) and B_{RPS} (Red) vs.
Operating Temperature at $V_{DD}=3.0\text{ V}$

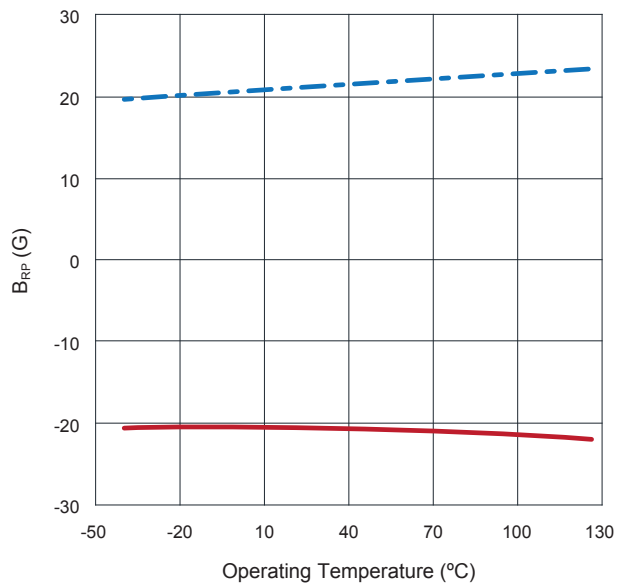

16 Graphs - Typical Electrical Characteristics

$V_{DD} = 3.0\text{ V}$ and $T_A = +25\text{ }^\circ\text{C}$, $C_{DD} = 1.0\text{ }\mu\text{F}$ (unless otherwise specified)

16.33 RR121-1B93-312
Average Supply Current vs.
Supply Voltage vs. Temperature

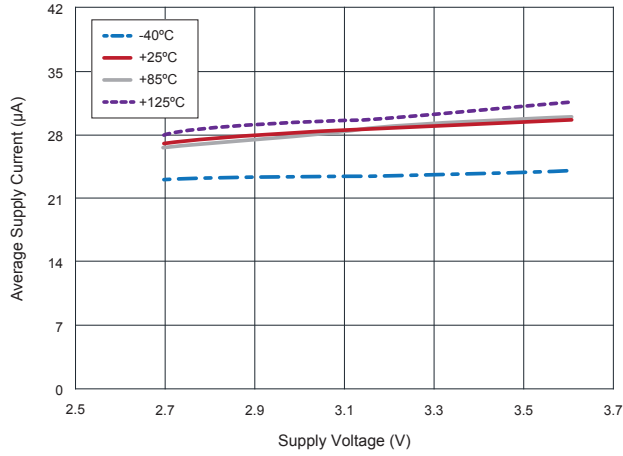

16.34 RR121-1B93-312
Average Supply Current vs.
Temperature vs. Supply Voltage

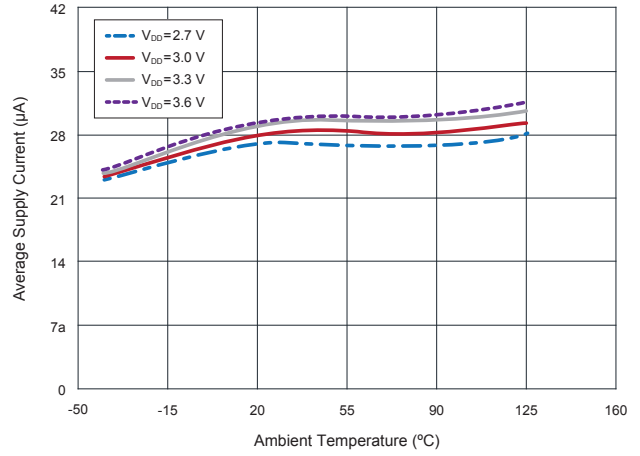

17 Application Information

17.1 Application Circuit (SOT-23-3)

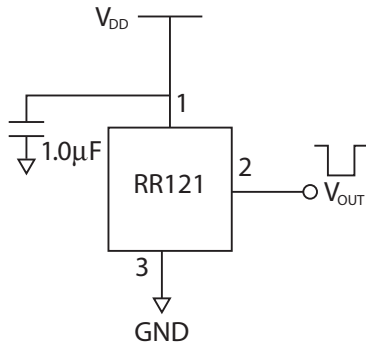

17.2 Application Circuit (LGA-4)

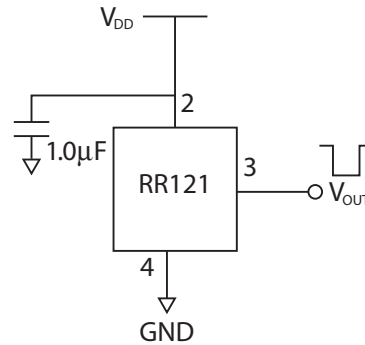

17.3 Application Circuit (Leaded LGA-4)

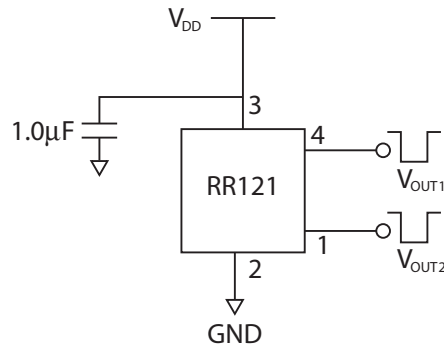

RR121 Push-Pull Output Application Circuit

The output voltage on the RR121 is active low, meaning that while a sufficiently strong magnetic field is present, the output voltage is low. The output voltage can be connected to a digital I/O pin on a microcontroller. A decoupling capacitor between the supply voltage and ground is required with placement close to the magnetic sensor. A typical capacitor value of $1.0\mu F$ will suffice.

18 Part Selection and Ordering Information

18.1 Part Selection Table

Part Number	Magnetic Polarity Response	Operate Sensitivity (G)	Release Sensitivity (G)	Frequency (Hz)	I _{avg} (μA)	Temp. Rating (°C)	Supply Voltage (V _{dd})	Output Response	Package
RR121-1B13-312	Omnipolar	30	20	2	0.20	-40 - +125	2.7 - 3.6	Active Low	LGA-4
RR121-1B13-311	Omnipolar	30	20	2	0.20	-40 - +125	2.7 - 3.6	Active Low	SOT-23-3
RR121-1B53-311	Omnipolar	30	20	250	1.44	-40 - +125	2.7 - 3.6	Active Low	SOT-23-3
RR121-1A23-311	Omnipolar	9	5	10	0.24	-40 - +125	2.7 - 3.6	Active Low	SOT-23-3
RR121-1A53-311	Omnipolar	9	5	250	1.44	-40 - +125	2.7 - 3.6	Active Low	SOT-23-3
RR121-1E73-311	Omnipolar	15	10	2500	8	-40 - +125	2.7 - 3.6	Active Low	SOT-23-3
RR121-1B93-312	Omnipolar	30	20	10000	36	-40 - +125	2.7 - 3.6	Active Low	LGA-4
RR121-2A32-364	Unipolar	9	5	20	0.28	-40 - +85	2.7 - 3.6	Dual Active Low	Leaded LGA-4
RR121-3C63-311	Bipolar	-10	10	500	1.70	-40 - +125	2.7 - 3.6	Active Low	SOT-23-3
RR121-3C73-311	Bipolar	-10	10	2500	8	-40 - +125	2.7 - 3.6	Active Low	SOT-23-3

Note:

- Custom options available for Sensitivity, Frequency, Temperature Rating, Supply Voltage, Output Response & more. Please contact redrock@cotorelay.com for more details.

18.2 Device Nomenclature

Ordering Information

RR121-X X X X-YY

Series Magnetic Polarity Response 1 = Omnipolar 3 = Bipolar/Latch 2 = Unipolar	Magnetic Sensitivity A: Op 9, Rel 5 E: Op 15, Rel 10 B: Op 30, Rel 20 F: Op 70, Rel 50 C: Op 10, Rel -10	Package 1: SOT-23-3 2: LGA-4 4: Leaded LGA-4 (Dual Active Low Output Only)
Clock Frequency (Hz) 1: 2 Hz 5: 250 Hz 9: 10000 Hz 2: 10 Hz 6: 500 Hz 3: 20 Hz 7: 2500 Hz	Output Response 1: Active Low 6: Dual Active Low	Supply Voltage/Output 3: 3V
		Temp Rating (°C) 2: -40- +85 3: -40- +125

19 Axis of Sensitivity

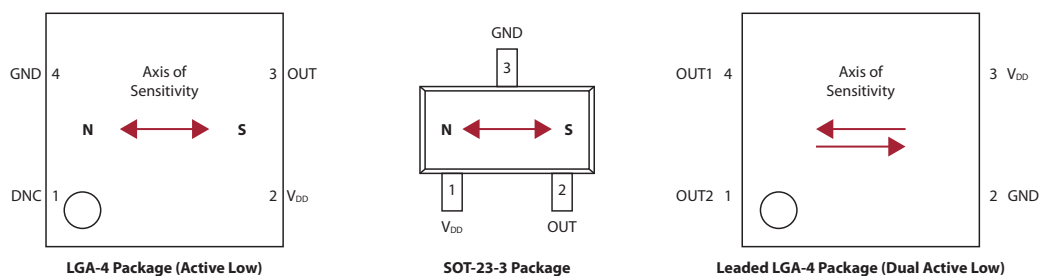

20 Dimensions *Millimeters (Inches)*

20.1 LGA-4 Package

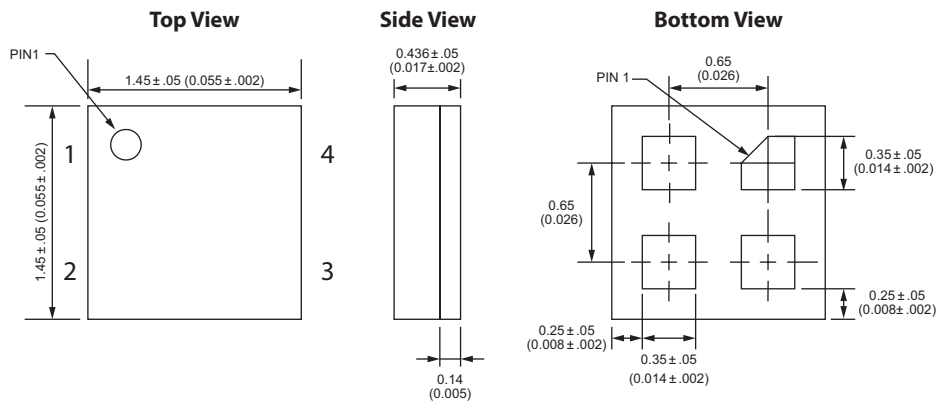

20.2 SOT-23-3 Package

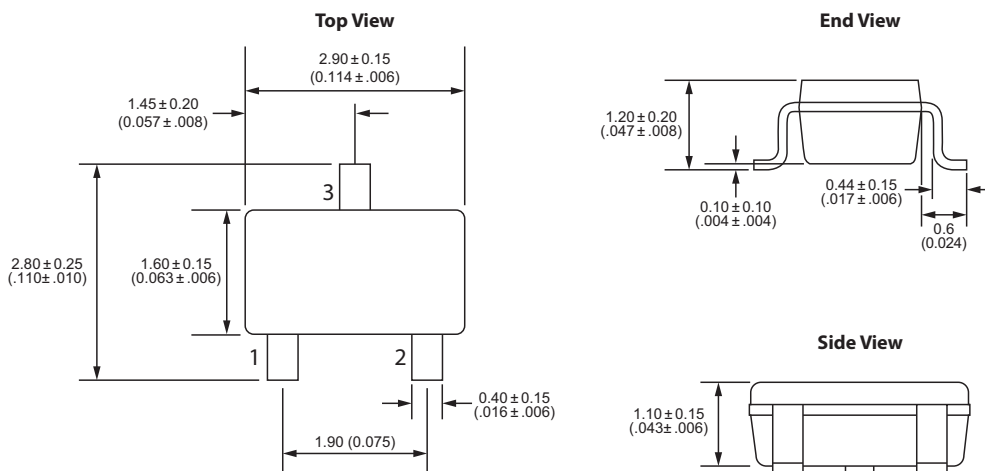

20.3 Leaded LGA-4 Package

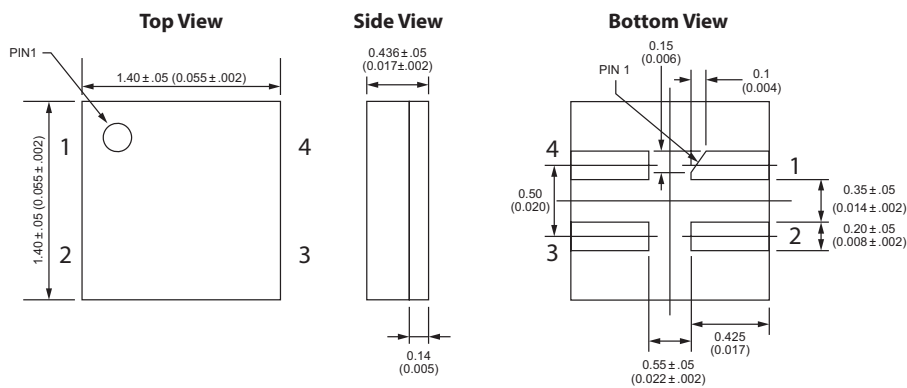

21 TMR Sensor Location

21.1 LGA Package

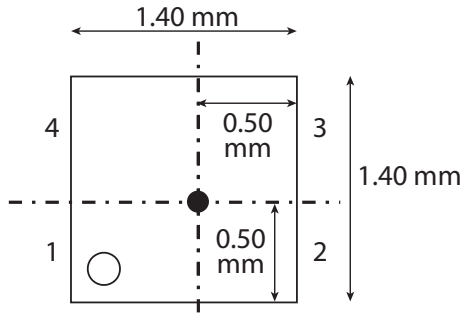

21.2 SOT Package

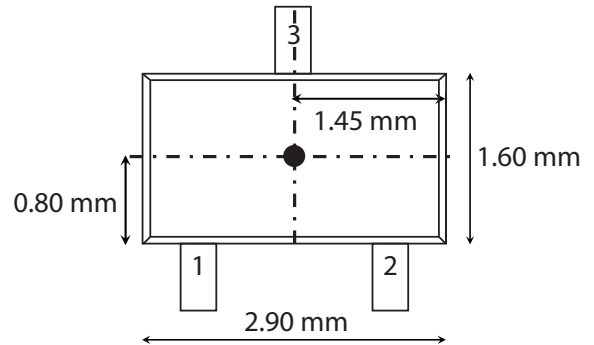

21.3 Leaded LGA Package

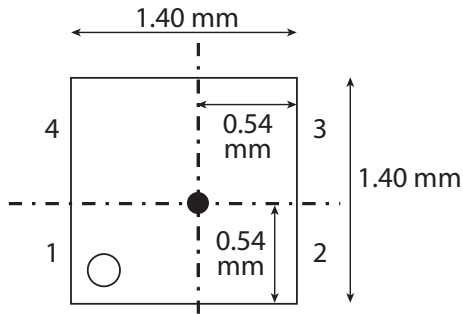

21.4 SOT Package - Side View

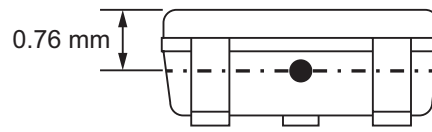

21.5 LGA & Leaded LGA Package - Side View

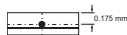

22 Magnetic Flux Response Diagrams

22.1 Omnipolar Magnetic Flux Response (Active Low Option)

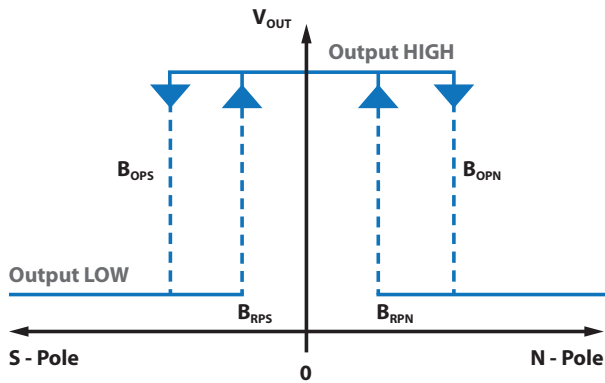

22.2 Bipolar Magnetic Flux Response (Active Low Option)

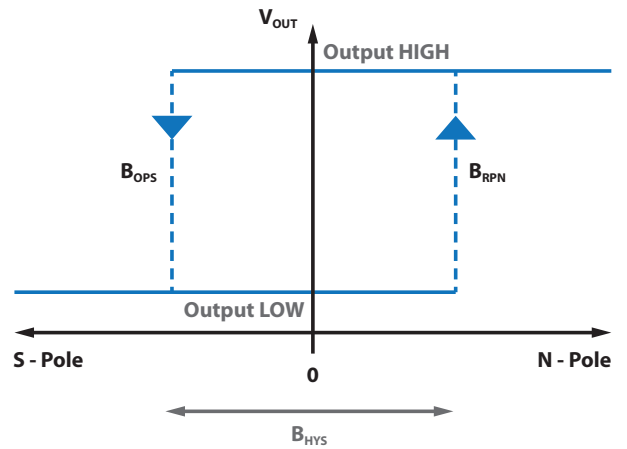

22.3 Unipolar Magnetic Flux Response (Dual Active Low Option)

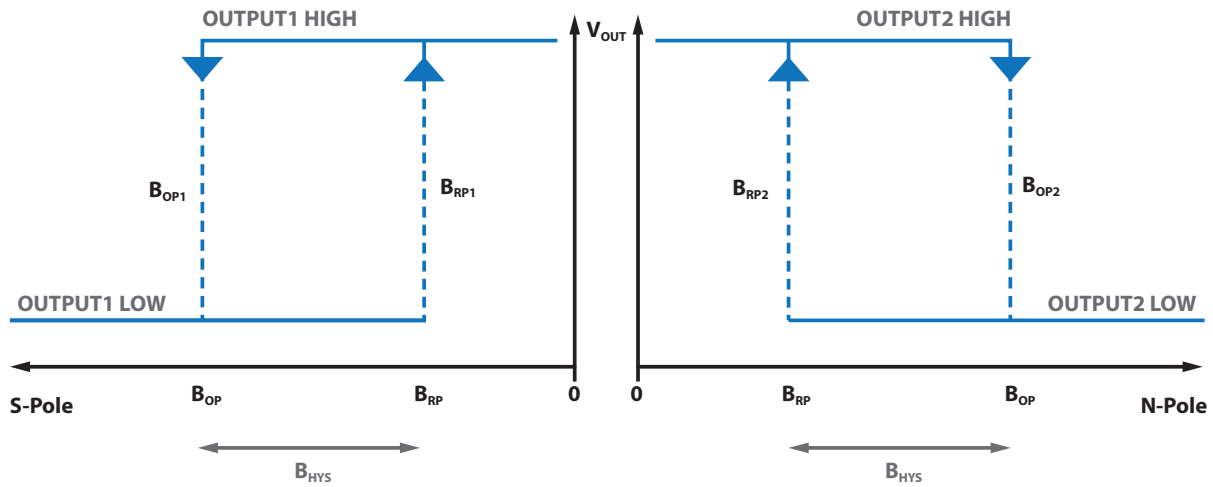

23 Output Behavior vs. Magnetic Field Diagrams

23.1 Output Behavior vs. Magnetic Field - Omnipolar

Characteristics	Conditions	Output
South Pole	$B < B_{OPS}$ $0 > B > B_{RPS}$	Low (ON) High (OFF)
North Pole	$B > B_{OPN}$ $0 < B < B_{RPN}$	Low (ON) High (OFF)

23.2 Output Behavior vs. Magnetic Field - Bipolar

Characteristics	Conditions	Output
South Pole	$B < B_{OPS}$	Low (ON)
North Pole	$B > B_{RPN}$	High (OFF)

23.3 Output Behavior vs. Magnetic Field - Unipolar (Dual Output)

OUTPUT2: North Field

Characteristics	Conditions	Output
South Field	$B > B_{OP}$	High (OFF)
Null or Weak Magnetic Field	$B < B_{RP}$	High (OFF)
North Field	$B > B_{OP}$	Low (ON)

OUTPUT1: South Field

Characteristics	Conditions	Output
North Field	$B > B_{OP}$	High (OFF)
Null or Weak Magnetic Field	$B < B_{RP}$	High (OFF)
South Field	$B > B_{OP}$	Low (ON)

24 TMR Sensor & Switch Packaging

24.3 RedRock TMR Packaging

Box Dimensions – 14x10x6 inches

- Fits 1 to 3 reels = 3000 to 9000 pcs
- Weight for 3000 pcs = 0.90 kilos
- Weight for 9000 pcs = 1.00 kilos

Box Dimensions – 18x14x12 inches

- Fits 4 to 24 reels = 12000 to 72000 pcs
- Weight for 12000 pcs = 1.50 kilos
- Weight for 72000 pcs = 4.90 kilos

25 Suggested Pb-Free Reflow Profile

- Notes:**
1. Fully compatible with standard no-lead solder profile, 260 °C for 30 seconds max (3 cycles max).
 2. Profile shown as example. Users are advised to develop their own board-level profile.
 3. Suggested Pb-free reflow profile derived from IPC/JEDEC J-STD-020E.
 4. Temperature tolerance: +0 °C, as measured at any point on the package or leads
 5. MSL rating of 1 (SOT-23-3 only) compatible with J-STD-020 or equivalent.
 6. MSL rating of 3 (LGA-4 and Leaded LGA-4) compatible with J-STD-020 or equivalent.
 7. All temperatures refer to the center of the package, measured on the package body surface that is facing up during assembly reflow (e.g., live-bug). If parts are reflowed in other than the normal live bug assembly reflow orientation (i.e., dead-bug), Tp shall be within ± 2 °C of the live bug Tp and still meet the Tc requirements, otherwise, the profile shall be adjusted to achieve the latter. To accurately measure actual peak package body temperatures, refer to JEP140 for recommended thermocouple use.
 8. Reflow profiles in this document are for classification/preconditioning and are not meant to specify board assembly profiles. Actual board assembly profiles should be developed based on specific process needs and board designs and should not exceed the parameters in this table.

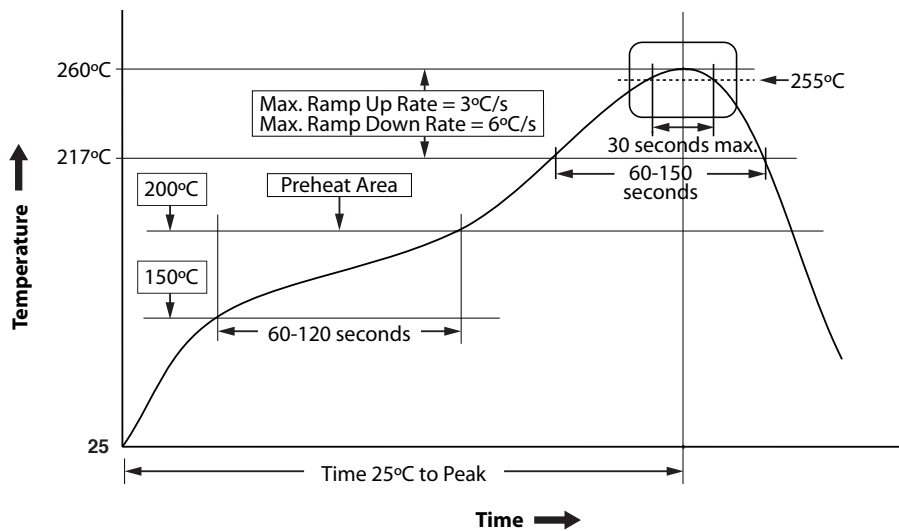

26 Suggested Solder Pad Layout

Dimensions in mm (inches)

26.1 SOT -23-3 Solder Pad Layout

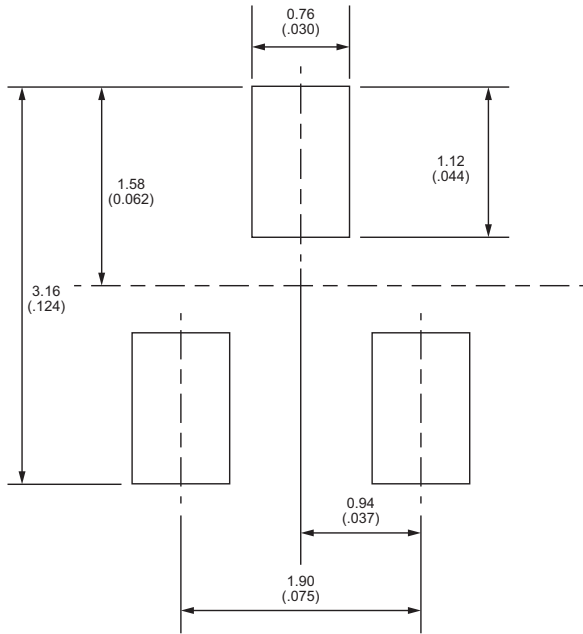

26.2 LGA-4 Solder Pad Layout

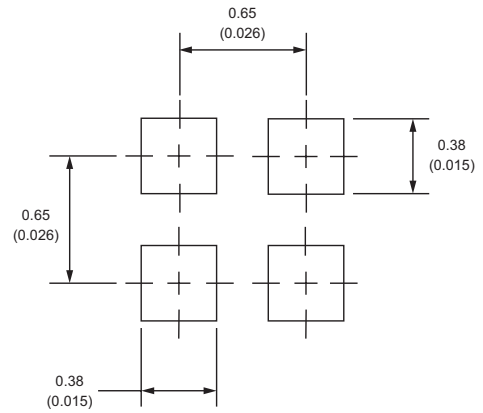

26.3 Leaded LGA-4 Solder Pad Layout

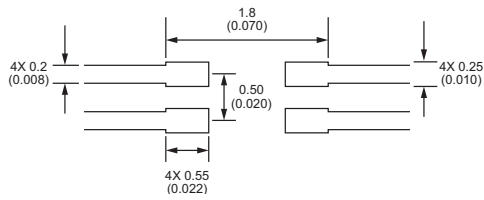

Looking for pricing, stock, or lifecycle information?

Click below to explore more details on WIN SOURCE:

 [View RR121-1B53-311](#) on WIN SOURCE

 [Coto Technology](#) Information

Optimize Your Supply Chain with WIN SOURCE Solutions

-  Global Sourcing Solution
-  Obsolete Management
-  Cost Control Management
-  Shortage Management
-  Alternative Solution
-  Excess Inventory Management