



**THE DATASHEET OF
RT9089AGQW**



DDR Termination Regulator

General Description

The RT9089A is a sink/source tracking termination regulator. It is specifically designed for low-cost and low-external component count systems. The RT9089A possesses a high speed operating amplifier that provides fast load transient response and only requires a minimum 10µF ceramic output capacitor. The RT9089A supports remote sensing functions and all features required to power the DDRI/DDRII/DDRIII/DDRIV/LPDDRII/LPDDRIII VTT bus termination according to the JEDEC specification.

The RT9089A is available in the thermal efficient package, WDFN-10L 2x2.

Ordering Information

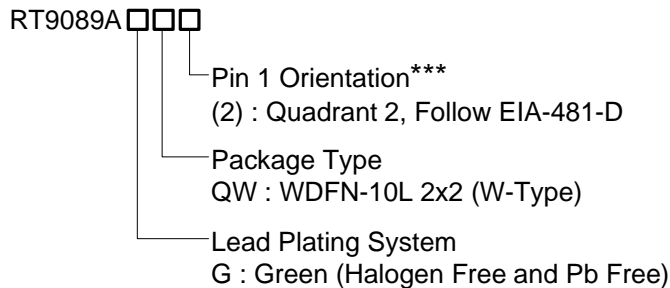

Note :

***Empty means Pin1 orientation is Quadrant 1

Richtek products are :

- ▶ RoHS compliant and compatible with the current requirements of IPC/JEDEC J-STD-020.
- ▶ Suitable for use in SnPb or Pb-free soldering processes.

Features

- VIN Input Voltage Range : 1.1V to 3.5V
- VCNTL Input Voltage Range : 2.9V to 5.5V
- Support Ceramic Capacitors
- 10mA Source/Sink Reference Output
- Meet DDRI, DDRII JEDEC Spec
- Support DDRIII, DDRIV, LPDDRII and LPDDRIII Applications

- Soft-Start Function
- UVLO and OCP Protection
- Thermal Shutdown

Applications

- Notebook/Desktop/Server
- Telecom/Datacom, GSM Base Station, LCD-TV/PDP-TV, Copier/Printer, Set-Top Box

Marking Information

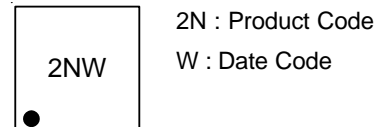

Pin Configuration

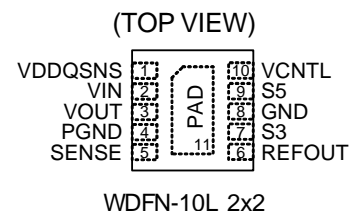

Simplified Application Circuit

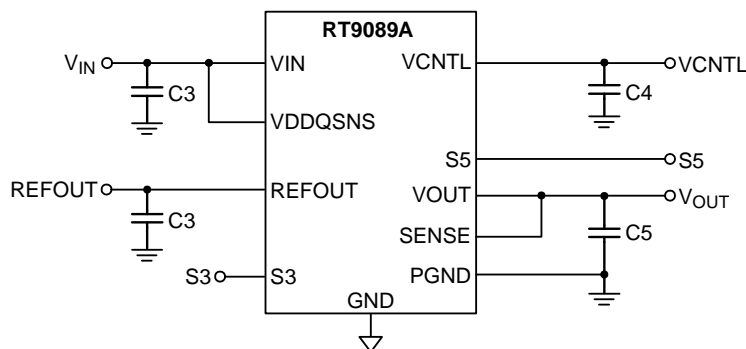

Functional Pin Description

Pin No.	Pin Name	Pin Function
1	VDDQSNS	Reference input.
2	VIN	Power input of the regulator.
3	VOUT	Power output of the regulator.
4	PGND	Power ground of the regulator.
5	SENSE	Voltage sense input for the regulator. Connect to positive terminal of the output capacitor or the load.
6	REFOUT	Reference output. Connect to GND through a 0.1μF ceramic capacitor.
7	S3	S3 signal input.
8	GND	Analog ground. Connect to negative terminal of the output capacitor.
9	S5	S5 signal input.
10	VCNTL	Control voltage input. Connect this pin to the 3.3V or 5V power supply. A 4.7μF ceramic decoupling capacitor is required.
11 (Exposed Pad)	PAD	Exposed pad. The exposed pad is internally unconnected and must be soldered to a large PGND plane. Connect this PGND plane to other layers with thermal vias to help dissipate heat from the device.

Functional Block Diagram

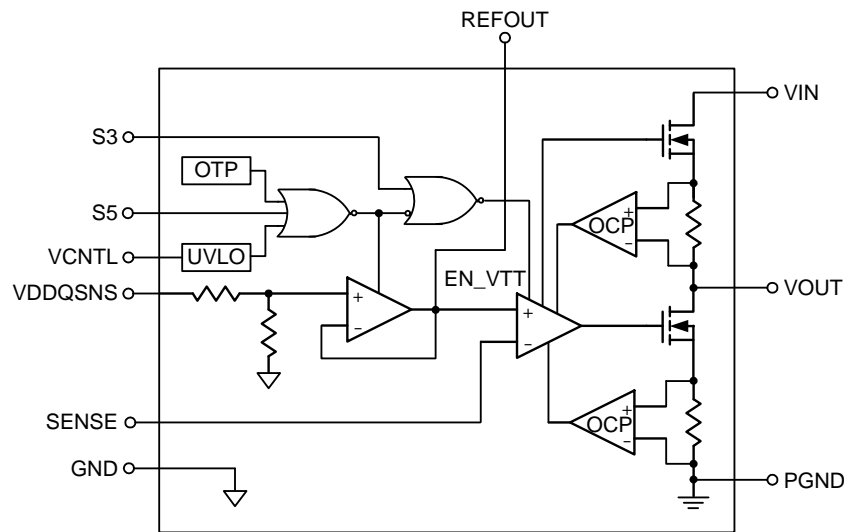

Operation

The RT9089A is a linear sink/source DDR termination regulator with current capability up to 2A. The RT9089A builds in a high-side N-MOSFET which provides current sourcing and a low-side N-MOSFET which provides current sinking. All the control circuits are supplied by the power VCNTL. In normal operation, the error amplifier OP adjusts the gate driving voltage of the power MOSFET to achieve SENSE voltage well tracking the VDDQSNS/2 voltage.

Both the source and sink currents are detected by the internal sensing resistor, and the OCP function will work to limit the current to a designed value when overload happens. Furthermore, the current will be folded back to be one half if VOUT is out of the power good window.

Buffer

This function provides REFOUT output level which is equal to VDDQSNS/2 with 10mA source/sink current capability.

Control Logic

This block includes VCNTL UVLO, VDDQSNS UVLO and Enable/Disable functions, and provides logic control to the whole chip.

Thermal Protection

Both the high-side and low-side power MOSFETs will be turned off when the junction temperature is higher than typically 160°C, and be released to normal operation when junction temperature falls below 120°C typically.

Power State Control

The input pins S3 and S5 of RT9089A, provide simple control of the power state. Table 1 describes S3/S5 terminal logic state and corresponding state of REFOUT/VOUT outputs. VOUT is turn-off and discharged to GND in state S3. When both S5 and S3 pins are LOW, the power state is set to S4/S5. In S4/S5 state, all the outputs are turn-off and discharged to GND.

Table 1. S3 and S5 Control Table

STATE	S3	S5	REFOUT	VOUT
S0	HI	HI	ON	ON
S3	LO	HI	ON	OFF (Discharge)
S4/S5	LO	LO	OFF (Discharge)	OFF (Discharge)

Absolute Maximum Ratings (Note 1)

- Supply Voltage, V_{IN} , V_{CNTL} ----- -0.3V to 6V
- Input Voltage, S_3 , V_{DQSNS} , $SENSE$, S_5 ----- -0.3V to 6V
- Output Voltage, V_{OUT} , REF_{OUT} ----- -0.3V to 6V
- Power Dissipation, P_D @ $T_A = 25^\circ\text{C}$
- WDFN-10L 2x2 ----- 1.25W
- Package Thermal Resistance (Note 2)
- WDFN-10L 2x2, θ_{JA} ----- 80°C/W
- WDFN-10L 2x2, θ_{JC} ----- 7°C/W
- Lead Temperature (Soldering, 10 sec.) ----- 260°C
- Junction Temperature ----- 150°C
- Storage Temperature Range ----- -65°C to 150°C
- ESD Susceptibility (Note 3)
- HBM (Human Body Model) ----- 2kV

Recommended Operating Conditions (Note 4)

- Control Input Voltage, V_{CNTL} ----- 2.9V to 5.5V
- Supply Input Voltage, V_{IN} ----- 1.1V to 3.5V
- Junction Temperature Range ----- -40°C to 125°C
- Ambient Temperature Range ----- -40°C to 85°C

Electrical Characteristics

($V_{IN} = V_{DQSNS} = 1.5\text{V}$, $V_{CNTL} = 3.3\text{V}$, $V_{SENSE} = 0.75\text{V}$, $C_{OUT} = 10\mu\text{F} \times 1$, $T_A = 25^\circ\text{C}$, unless otherwise specified)

Parameter	Symbol	Test Conditions	Min	Typ	Max	Unit
Supply Current						
VCNTL Supply Current	I_{VCNTL}	$V_{S3} = V_{CNTL}$, $V_{S5} = V_{CNTL}$, no load	--	0.7	1	mA
VCNTL Shutdown Current	I_{SHDN_VCNTL}	$V_{S3} = 0\text{V}$, $V_{S5} = 0\text{V}$, no load	--	65	80	μA
		$V_{S3} = 0\text{V}$, $V_{S5} = V_{CNTL}$, no load	--	200	400	μA
VIN Supply Current	I_{VIN}	$V_{S3} = V_{CNTL}$, $V_{S5} = V_{CNTL}$, no load	--	1	50	μA
VIN Shutdown Current	I_{SHDN_VIN}	$V_{S3} = 0\text{V}$, $V_{S5} = 0\text{V}$, no load	--	0.1	50	μA
Output						
VOUT Output Voltage	V_{OUT}	$V_{IN} = 1.5\text{V}$, $V_{DQSNS} = 1.5\text{V}$, $I_{OUT} = 0\text{A}$	--	0.75	--	V
		$V_{IN} = 1.35\text{V}$, $V_{DQSNS} = 1.35\text{V}$, $I_{OUT} = 0\text{A}$	--	0.675	--	V
		$V_{IN} = 1.2\text{V}$, $V_{DQSNS} = 1.2\text{V}$, $I_{OUT} = 0\text{A}$	--	0.6	--	V
VOUT Output Voltage Offset	V_{OUT_OS}	$I_{OUT} = \pm 2\text{A}$, $V_{IN} = 1.5\text{V}$, $V_{REF_{OUT}} = 0.75\text{V}$	-25	--	25	mV
		$I_{OUT} = \pm 2\text{A}$, $V_{IN} = 1.35\text{V}$, $V_{REF_{OUT}} = 0.675\text{V}$	-25	--	25	
		$I_{OUT} = \pm 2\text{A}$, $V_{IN} = 1.2\text{V}$, $V_{REF_{OUT}} = 0.6\text{V}$	-25	--	25	

Parameter	Symbol	Test Conditions	Min	Typ	Max	Unit
VOUT Source Current Limit	I _{LIM_VOUT_SR}	VOUT in PGOOD window	2	--	--	A
VOUT Sink Current Limit	I _{LIM_VOUT_SK}	VOUT in PGOOD window	2	--	--	A
VOUT Discharge Resistance	R _{DISCHARGE}	V _{VDDQSNS} = 0V, V _{OUT} = 0.3V, V _{S3} = 0V	--	18	25	Ω
VDDQSNS and REFOUT						
VDDQSNS Input Current	I _{VDDQSNS}	V _{VDDQSNS} = 1.8V	--	30	--	μA
VDDQSNS Voltage Range	V _{VDDQSNS}		0.5	--	1.8	V
REFOUT Voltage Tolerance to V _{VDDQSNS}	V _{TOL_REFOUT}	-10mA < I _{REFOUT} < 10mA, V _{VDDQSNS} = 1.5V	-15	--	15	mV
		-10mA < I _{REFOUT} < 10mA, V _{VDDQSNS} = 1.35V	-15	--	15	
		-10mA < I _{REFOUT} < 10mA, V _{VDDQSNS} = 1.2V	-12	--	12	
REFOUT Source Current Limit	I _{LIM_REFOUT_SR}	V _{REFOUT} = 0V	10	40	--	mA
REFOUT Sink Current Limit	I _{LIM_REFOUT_SK}	V _{REFOUT} = V _{VDDQSNS} / 2 + 1V	10	40	--	mA
UVLO/S3/S5						
UVLO Threshold	V _{UVLO_VCNTL}	Rising	2.5	2.7	2.85	V
		Hysteresis	--	120	--	mV
S3/S5 Input Voltage	Logic-High	V _{IN_H}	1.7	--	--	V
	Logic-Low	V _{IN_L}	--	--	0.3	
Thermal Shutdown						
Thermal Shutdown Threshold	T _{SD}	Shutdown temperature	--	160	--	°C
		Hysteresis	--	15	--	

Note 1. Stresses beyond those listed “Absolute Maximum Ratings” may cause permanent damage to the device. These are stress ratings only, and functional operation of the device at these or any other conditions beyond those indicated in the operational sections of the specifications is not implied. Exposure to absolute maximum rating conditions may affect device reliability.

Note 2. θ_{JA} is measured at T_A = 25°C on a high effective thermal conductivity four-layer test board per JEDEC 51-7. θ_{JC} is measured at the exposed pad of the package.

Note 3. Devices are ESD sensitive. Handling precaution is recommended.

Note 4. The device is not guaranteed to function outside its operating conditions.

Typical Application Circuit

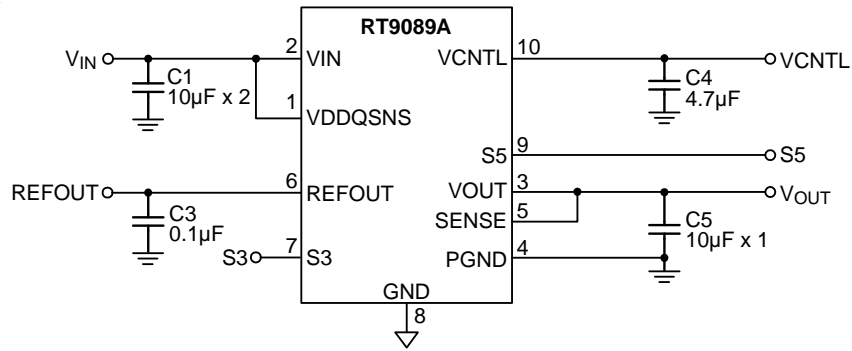

Typical Operating Characteristics

Output Voltage vs. Temperature

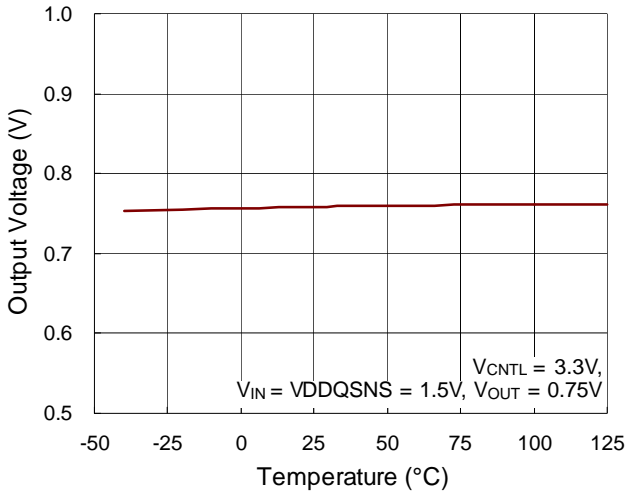

REFOUT Voltage vs. Temperature

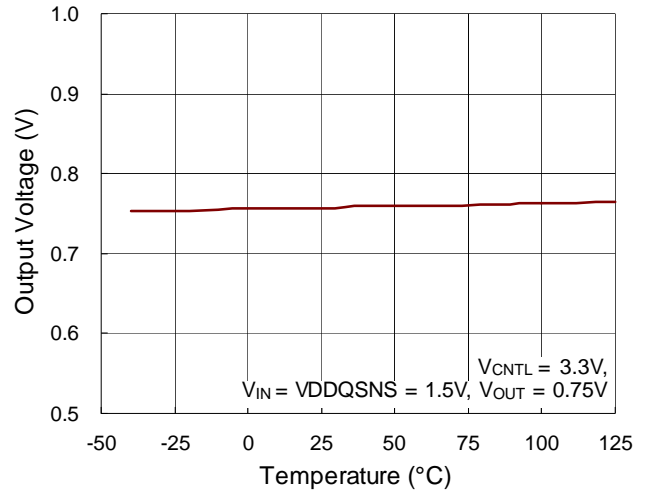

VCNTL Supply Current vs. Temperature

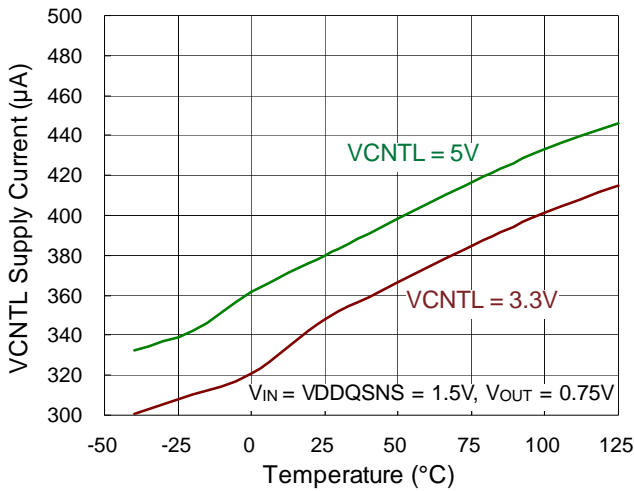

VCNTL Shutdown Current vs. Temperature

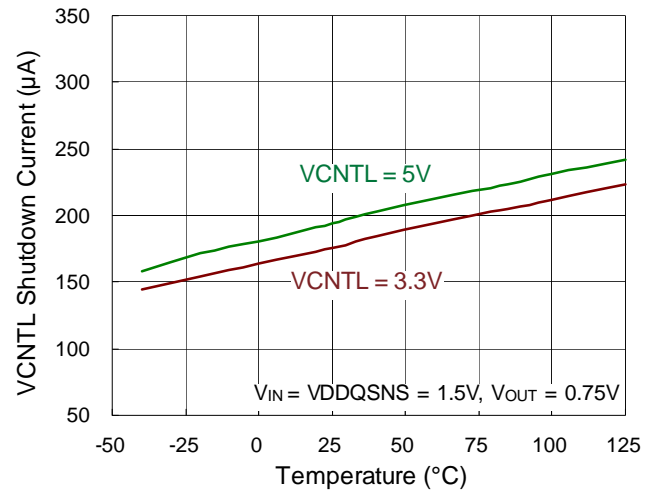

UVLO vs. Temperature

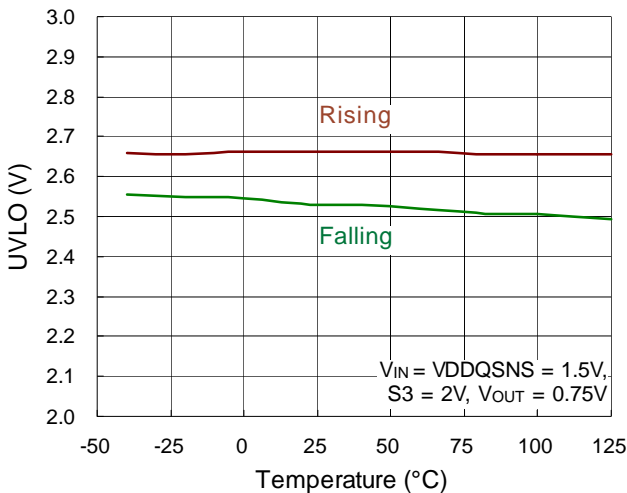

Sourcing Current Limit vs. Temperature

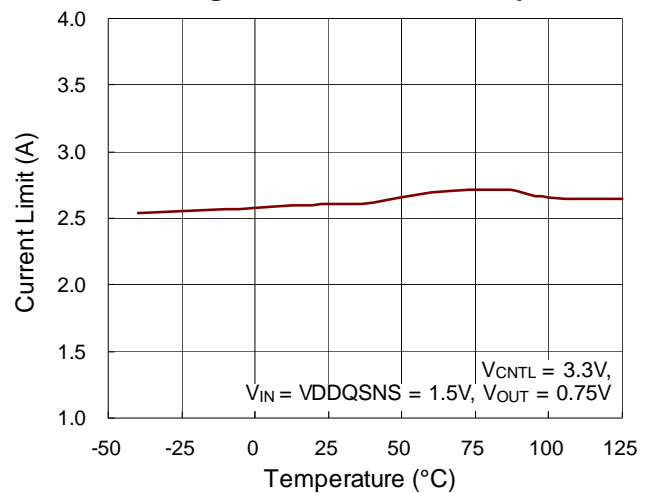

Sinking Current Limit vs. Temperature

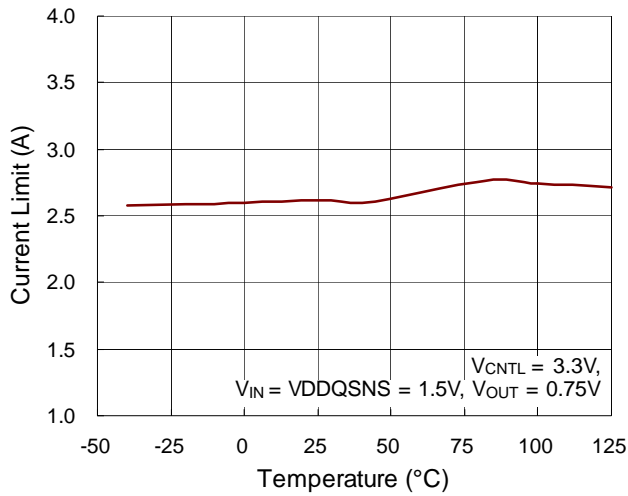

Power On from S3

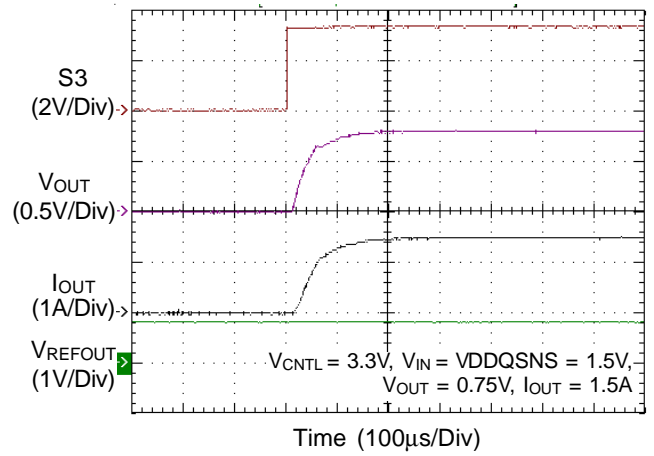

Power Off from S3

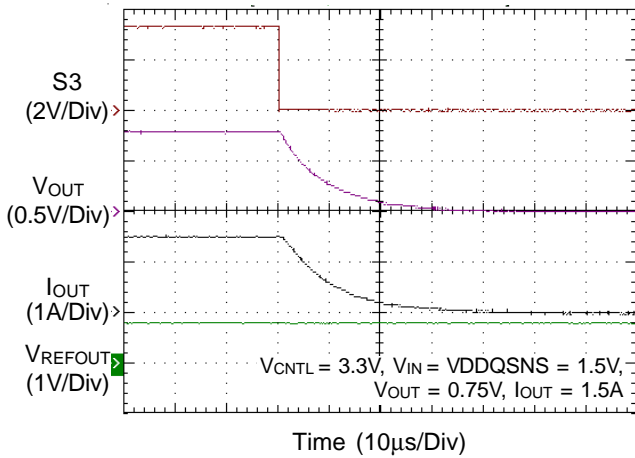

0.75V_{OUT} @ 1.5A Transient Response

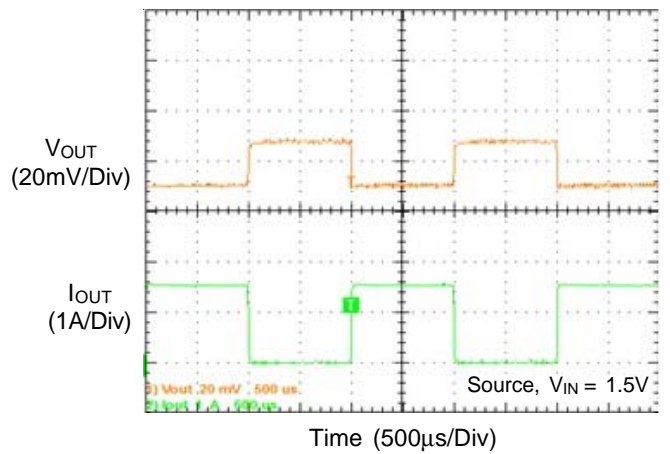

0.75V_{OUT} @ 1.5A Transient Response

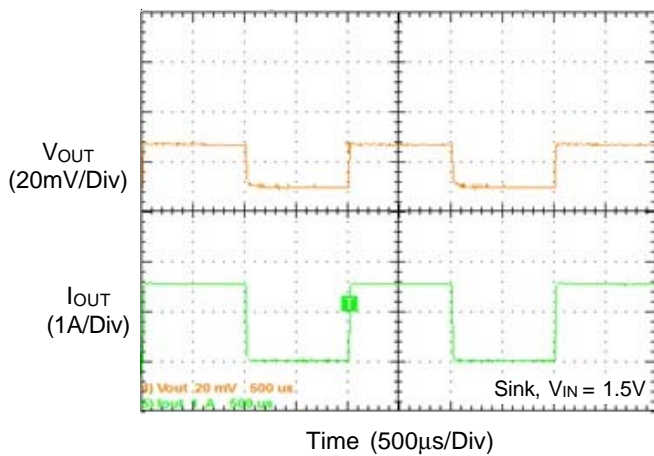

Application Information

The RT9089A is a 2A sink/source tracking termination regulator. It is specifically designed for low-cost and low-external component count system such as notebook PC applications. The RT9089A possesses a high speed operating amplifier that provides fast load transient response and only requires two 10μF ceramic input capacitor and a 10μF ceramic output capacitors.

Capacitor Selection

Good bypassing is recommended from VIN to GND to help improve AC performance. A 10μF or greater input capacitor placed as close as possible to the IC is recommended. The input capacitor must be located at a distance of less than 0.5 inches from the VIN pin of the IC.

The 1μF ceramic capacitor added close to the VCNTL pin should be kept away from any parasitic impedance from the supply power. For stable operation, the total capacitance of the ceramic capacitor at the VOUT output terminal must be larger than 10μF. The RT9089A is designed specifically to work with low ESR ceramic output capacitor in space saving and performance consideration. Larger output capacitance can reduce the noise and improve load transient response, stability and PSRR. The output capacitor should be located near the VOUT output terminal pin as close as possible.

Thermal Considerations

For continuous operation, do not exceed absolute maximum junction temperature. The maximum power dissipation depends on the thermal resistance of the IC package, PCB layout, rate of surrounding airflow, and difference between junction and ambient temperature. The maximum power dissipation can be calculated by the following formula :

$$P_{D(MAX)} = (T_{J(MAX)} - T_A) / \theta_{JA}$$

where $T_{J(MAX)}$ is the maximum junction temperature, T_A is the ambient temperature, and θ_{JA} is the junction to ambient thermal resistance.

For recommended operating condition specifications, the maximum junction temperature is 125°C. The junction to ambient thermal resistance, θ_{JA} , is layout dependent. For WDFN-10L 2x2 package, the thermal resistance, θ_{JA} , is

80°C/W on a standard JEDEC 51-7 four-layer thermal test board. The maximum power dissipation at $T_A = 25^\circ\text{C}$ can be calculated by the following formula :

$$P_{D(MAX)} = (125^\circ\text{C} - 25^\circ\text{C}) / (80^\circ\text{C/W}) = 1.25\text{W for WDFN-10L 2x2 package}$$

The maximum power dissipation depends on the operating ambient temperature for fixed $T_{J(MAX)}$ and thermal resistance, θ_{JA} . The derating curve in Figure 1 allows the designer to see the effect of rising ambient temperature on the maximum power dissipation.

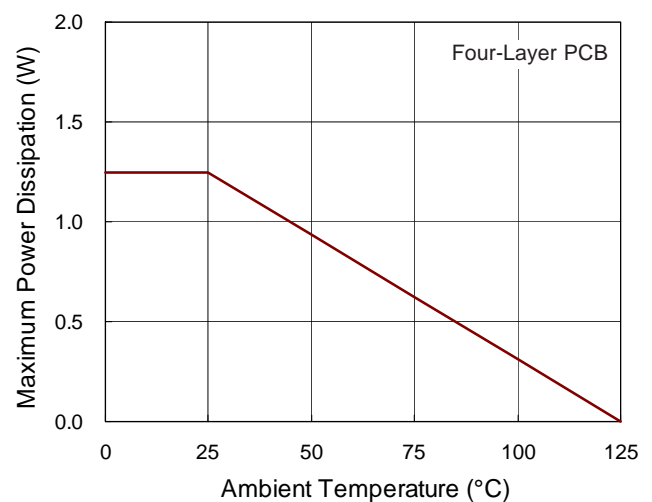
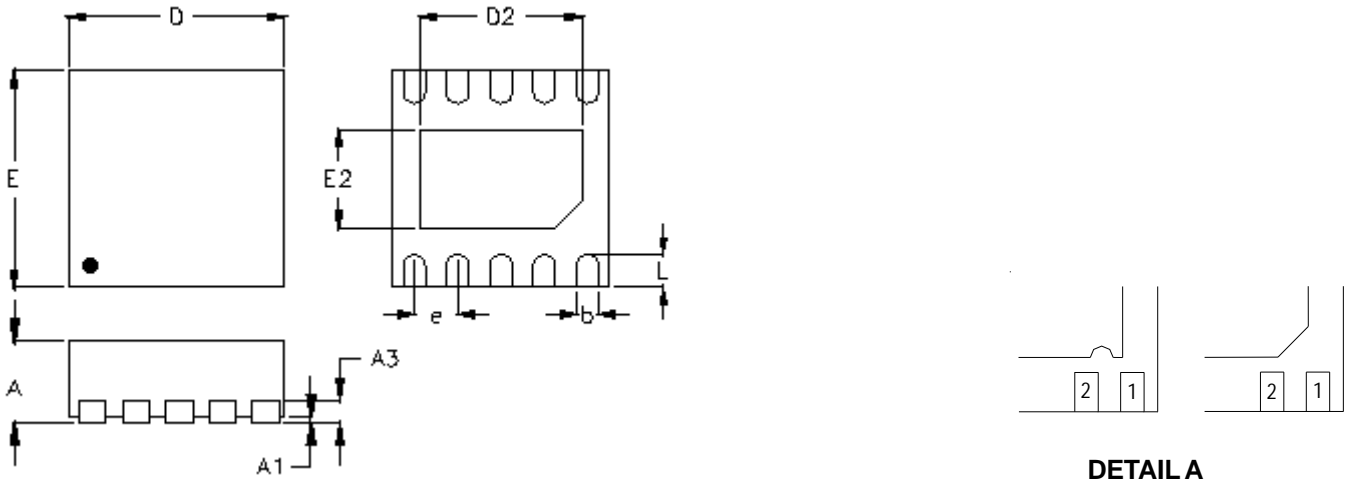

Figure 1. Derating Curve of Maximum Power Dissipation

Outline Dimension



DETAILA

Pin #1 ID and Tie Bar Mark Options

Note : The configuration of the Pin #1 identifier is optional, but must be located within the zone indicated.

Symbol	Dimensions In Millimeters		Dimensions In Inches	
	Min	Max	Min	Max
A	0.700	0.800	0.028	0.031
A1	0.000	0.050	0.000	0.002
A3	0.175	0.250	0.007	0.010
b	0.150	0.250	0.006	0.010
D	1.900	2.100	0.075	0.083
D2	1.450	1.550	0.057	0.061
E	1.900	2.100	0.075	0.083
E2	0.850	0.950	0.033	0.037
e	0.400		0.016	
L	0.250	0.350	0.010	0.014

W-Type 10L DFN 2x2 Package



Richtek Technology Corporation

14F, No. 8, Tai Yuen 1st Street, Chupei City
 Hsinchu, Taiwan, R.O.C.
 Tel: (8863)5526789





Richtek products are sold by description only. Customers should obtain the latest relevant information and data sheets before placing orders and should verify that such information is current and complete. Richtek cannot assume responsibility for use of any circuitry other than circuitry entirely embodied in a Richtek product. Information furnished by Richtek is believed to be accurate and reliable. However, no responsibility is assumed by Richtek or its subsidiaries for its use; nor for any infringements of patents or other rights of third parties which may result from its use. No license is granted by implication or otherwise under any patent or patent rights of Richtek or its subsidiaries.

Looking for pricing, stock, or lifecycle information?

Click below to explore more details on WIN SOURCE:

-  [View RT9089AGQW on WIN SOURCE](#)
-  [Richtek USA Inc. Information](#)

Optimize Your Supply Chain with WIN SOURCE Solutions

-  Global Sourcing Solution
-  Obsolete Management
-  Cost Control Management
-  Shortage Management
-  Alternative Solution
-  Excess Inventory Management