



# BFG325/XR

NPN 14 GHz wideband transistor

Rev. 2 — 15 September 2011

Product data sheet

## 1. Product profile

### 1.1 General description

NPN silicon planar epitaxial transistor in a 4-pin dual-emitter SOT143R plastic package.

### 1.2 Features and benefits

- High power gain
- Low noise figure
- High transition frequency
- Gold metallization ensures excellent reliability

### 1.3 Applications

- Intended for Radio Frequency (RF) front end applications in the GHz range, such as:
  - ◆ analog and digital cellular telephones
  - ◆ cordless telephones (Cordless Telephone (CT), Personal Communication Network (PCN), Digital Enhanced Cordless Telecommunications (DECT), etc.)
  - ◆ radar detectors
  - ◆ pagers
  - ◆ Satellite Antenna TeleVision (SATV) tuners
  - ◆ repeater amplifiers in fiber-optic systems

### 1.4 Quick reference data

Table 1. Quick reference data

Symbol	Parameter	Conditions	Min	Typ	Max	Unit
$V_{CBO}$	collector-base voltage	open emitter	-	-	15	V
$V_{CEO}$	collector-emitter voltage	open base	-	-	6	V
$I_C$	collector current (DC)		-	-	35	mA
$P_{tot}$	total power dissipation	$T_{sp} \leq 90\text{ }^\circ\text{C}$	<a href="#">[1]</a> -	-	210	mW
$h_{FE}$	DC current gain	$I_C = 15\text{ mA}; V_{CE} = 3\text{ V}; T_j = 25\text{ }^\circ\text{C}$	60	100	200	
$C_{CBS}$	collector-base capacitance	$V_{CB} = 5\text{ V}; f = 1\text{ MHz};$ emitter grounded	-	0.26	0.4	pF
$f_T$	transition frequency	$I_C = 15\text{ mA}; V_{CE} = 3\text{ V};$ $f = 1\text{ GHz}; T_{amb} = 25\text{ }^\circ\text{C}$	-	14	-	GHz



**Table 1. Quick reference data ...continued**

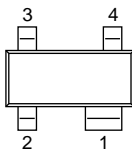
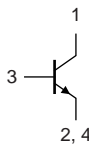
Symbol	Parameter	Conditions	Min	Typ	Max	Unit
$G_{max}$	maximum power gain <sup>[2]</sup>	$I_C = 15 \text{ mA}; V_{CE} = 3 \text{ V};$ $f = 1.8 \text{ GHz}; T_{amb} = 25 \text{ }^\circ\text{C}$	-	18.3	-	dB
$ S_{21} ^2$	insertion power gain	$I_C = 15 \text{ mA}; V_{CE} = 3 \text{ V};$ $f = 1.8 \text{ GHz}; T_{amb} = 25 \text{ }^\circ\text{C};$ $Z_S = Z_L = 50 \text{ } \Omega$	-	14	-	dB
NF	noise figure	$\Gamma_S = \Gamma_{opt}; I_C = 3 \text{ mA};$ $V_{CE} = 3 \text{ V}; f = 2 \text{ GHz}$	-	1.1	-	dB

[1]  $T_{sp}$  is the temperature at the soldering point of the collector pin.

[2]  $G_{max}$  is the maximum power gain, if  $K > 1$ . If  $K < 1$  then  $G_{max} = \text{MSG}$ , see [Figure 4](#).

## 2. Pinning information

**Table 2. Pinning**

Pin	Description	Simplified outline	Symbol
1	collector		
2	emitter		
3	base		
4	emitter		

*sym086*

## 3. Ordering information

**Table 3. Ordering information**

Type number	Package		Version
	Name	Description	
BFG325/XR	SC-61AA	plastic surface mounted package; reverse pinning; 4 leads	SOT143R

## 4. Marking

**Table 4. Marking codes**

Type number	Marking code <sup>[1]</sup>
BFG325/XR	S2*

[1] \* = p: made in Hong Kong.

## 5. Limiting values

**Table 5. Limiting values**

In accordance with the Absolute Maximum Rating System (IEC 60134).

Symbol	Parameter	Conditions	Min	Max	Unit
$V_{CBO}$	collector-base voltage	open emitter	-	15	V
$V_{CEO}$	collector-emitter voltage	open base	-	6	V
$V_{EBO}$	emitter-base voltage	open collector	-	2	V
$I_C$	collector current (DC)		-	35	mA
$P_{tot}$	total power dissipation	$T_{sp} \leq 90\text{ °C}$	[1]	210	mW
$T_{stg}$	storage temperature		-65	+175	°C
$T_j$	junction temperature		-	175	°C

[1]  $T_{sp}$  is the temperature at the soldering point of the collector pin.

## 6. Thermal characteristics

**Table 6. Thermal characteristics**

Symbol	Parameter	Conditions	Typ	Unit
$R_{th(j-sp)}$	thermal resistance from junction to solder point	$T_{sp} \leq 90\text{ °C}$	[1]	405 K/W

[1]  $T_{sp}$  is the temperature at the soldering point of the collector pin.

## 7. Characteristics

**Table 7. Characteristics**

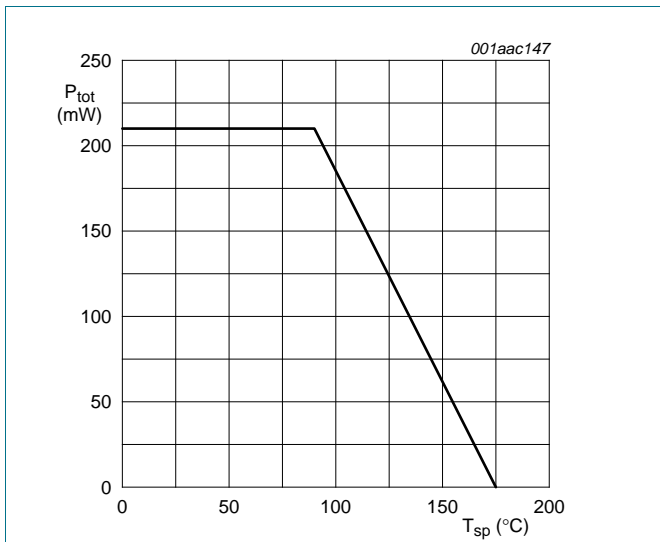
$T_j = 25\text{ °C}$ ; unless otherwise specified.

Symbol	Parameter	Conditions	Min	Typ	Max	Unit
$I_{CBO}$	collector-base cut-off current	$I_E = 0\text{ A}$ ; $V_{CB} = 5\text{ V}$	-	-	15	nA
$h_{FE}$	DC current gain	$I_C = 15\text{ mA}$ ; $V_{CE} = 3\text{ V}$	60	100	200	
$C_{CBS}$	collector-base capacitance	$V_{CB} = 5\text{ V}$ ; $f = 1\text{ MHz}$ ; emitter grounded	-	0.26	0.4	pF
$C_{CES}$	collector-emitter capacitance	$V_{CE} = 5\text{ V}$ ; $f = 1\text{ MHz}$ ; base grounded	-	0.27	-	pF
$C_{EBS}$	emitter-base capacitance	$V_{EB} = 0.5\text{ V}$ ; $f = 1\text{ MHz}$ ; collector grounded	-	0.53	-	pF
$f_T$	transition frequency	$I_C = 15\text{ mA}$ ; $V_{CE} = 3\text{ V}$ ; $f = 1\text{ GHz}$ ; $T_{amb} = 25\text{ °C}$	-	14	-	GHz
$G_{max}$	maximum power gain[1]	$I_C = 15\text{ mA}$ ; $V_{CE} = 3\text{ V}$ ; $f = 1.8\text{ GHz}$ ; $T_{amb} = 25\text{ °C}$	-	18.3	-	dB
$ S_{21} ^2$	insertion power gain	$I_C = 15\text{ mA}$ ; $V_{CE} = 3\text{ V}$ ; $T_{amb} = 25\text{ °C}$ ; $Z_S = Z_L = 50\text{ }\Omega$				
		$f = 1.8\text{ GHz}$	-	14	-	dB
		$f = 3\text{ GHz}$	-	10	-	dB
NF	noise figure	$\Gamma_s = \Gamma_{opt}$ ; $I_C = 3\text{ mA}$ ; $V_{CE} = 3\text{ V}$ ; $f = 2\text{ GHz}$	-	1.1	-	dB
$P_{L(1dB)}$	output power at 1 dB gain compression	$I_C = 15\text{ mA}$ ; $V_{CE} = 3\text{ V}$ ; $f = 1.8\text{ GHz}$ ; $T_{amb} = 25\text{ °C}$ ; $Z_S = Z_L = 50\text{ }\Omega$	-	8.7	-	dBm
IP3	third order intercept point	$I_C = 15\text{ mA}$ ; $V_{CE} = 3\text{ V}$ ; $f = 1.8\text{ GHz}$ ; $T_{amb} = 25\text{ °C}$ ; $Z_S = Z_L = 50\text{ }\Omega$	-	19.4	-	dBm

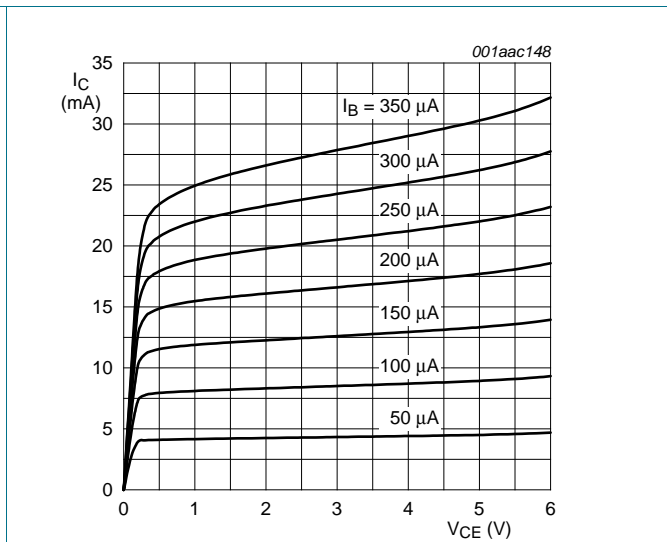
[1]  $G_{max}$  is the maximum power gain, if  $K > 1$ . If  $K < 1$  then  $G_{max} = MSG$ , see [Figure 4](#).

$K$  is the Rollet stability factor: 
$$K = \frac{1 + |Ds|^2 - |s_{11}|^2 - |s_{22}|^2}{2 \times |s_{21}| \times |s_{12}|}$$
 where  $Ds = s_{11} \times s_{22} - s_{12} \times s_{21}$ .

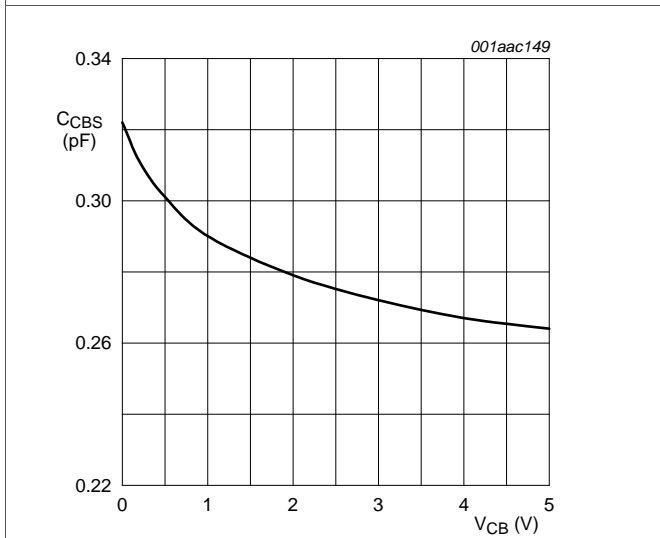
MSG = maximum stable gain.



**Fig 1. Power derating curve**

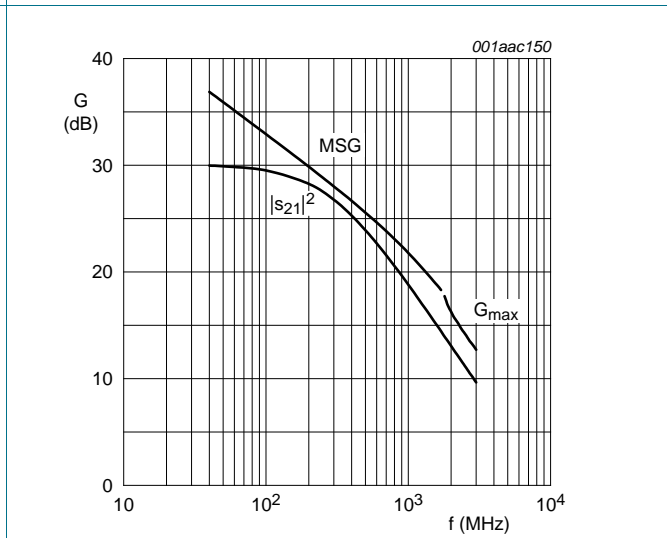


**Fig 2. Collector current as a function of collector-emitter voltage; typical values**



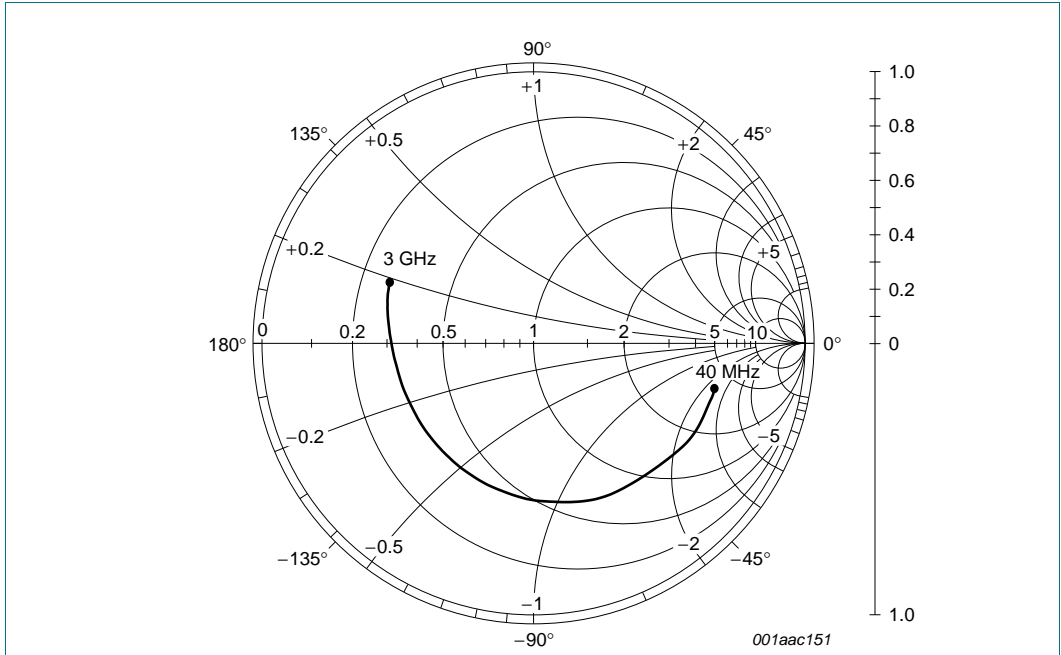
$I_C = 0 \text{ mA}$ ;  $f = 1 \text{ MHz}$ .

**Fig 3. Collector-base capacitance as a function of collector-base voltage; typical values**



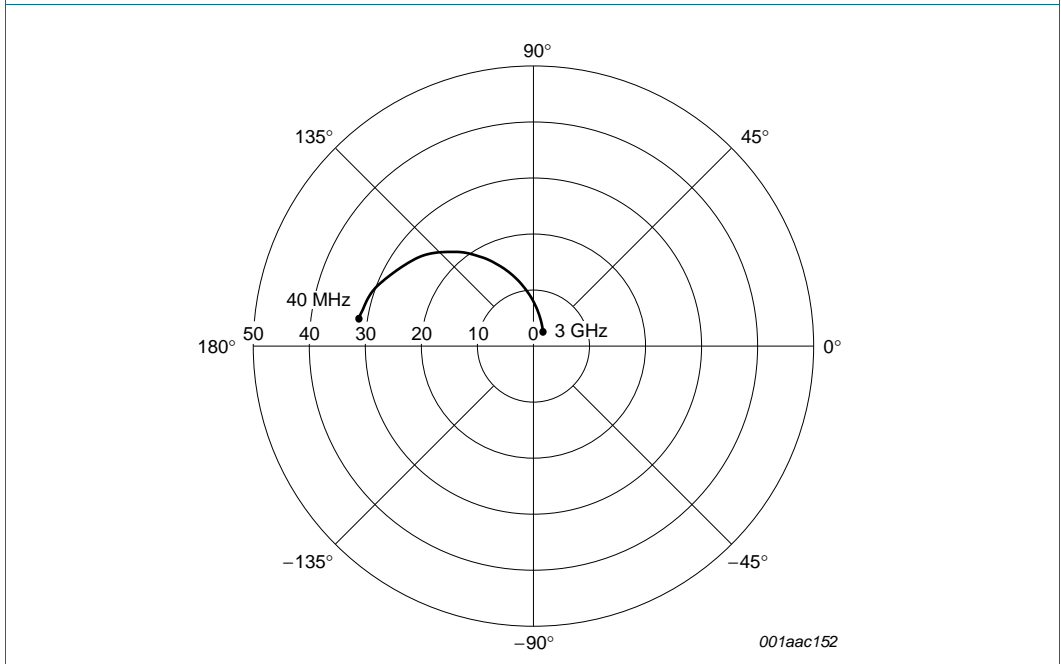
$I_C = 15 \text{ mA}$ ;  $V_{CE} = 3 \text{ V}$ .

**Fig 4. Gain as a function of frequency; typical values**



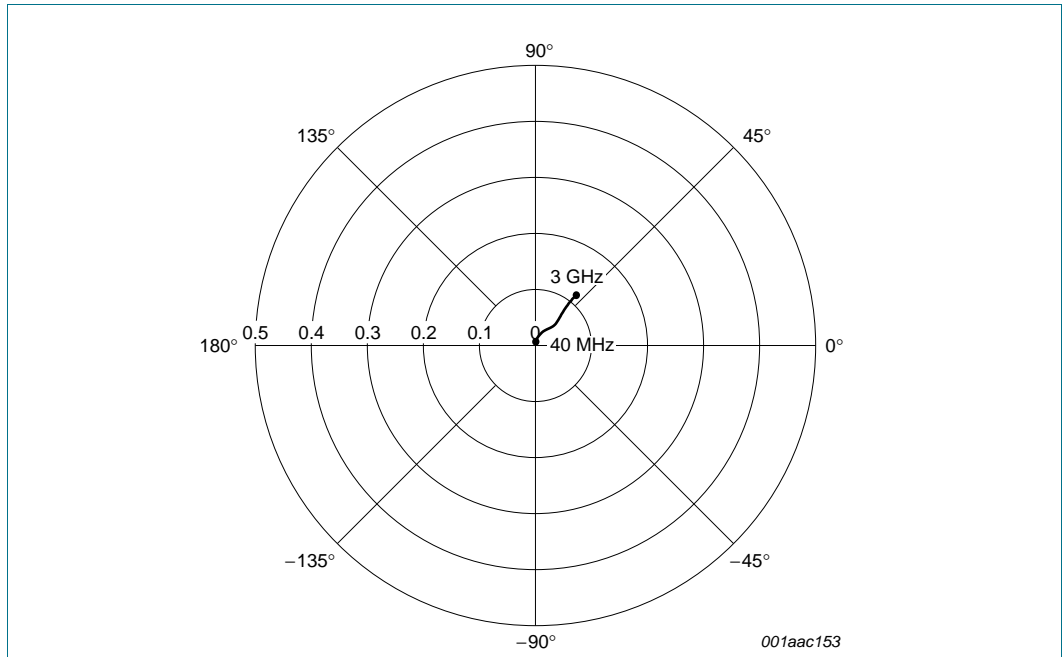
$V_{CE} = 3\text{ V}; I_C = 15\text{ mA}; Z_o = 50\ \Omega.$

**Fig 5. Common emitter input reflection coefficient ( $s_{11}$ ); typical values**



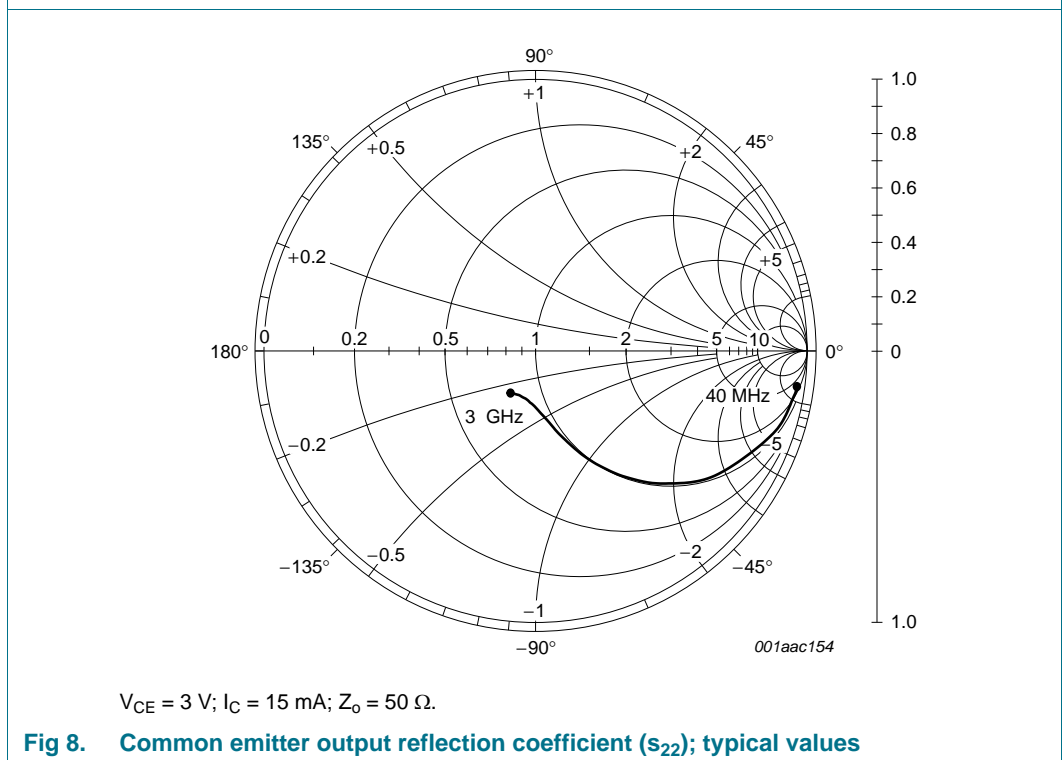
$V_{CE} = 3\text{ V}; I_C = 15\text{ mA}.$

**Fig 6. Common emitter forward transmission coefficient ( $s_{21}$ ); typical values**



$V_{CE} = 3\text{ V}; I_C = 15\text{ mA}$ .

**Fig 7. Common emitter reverse transmission coefficient ( $s_{12}$ ); typical values**



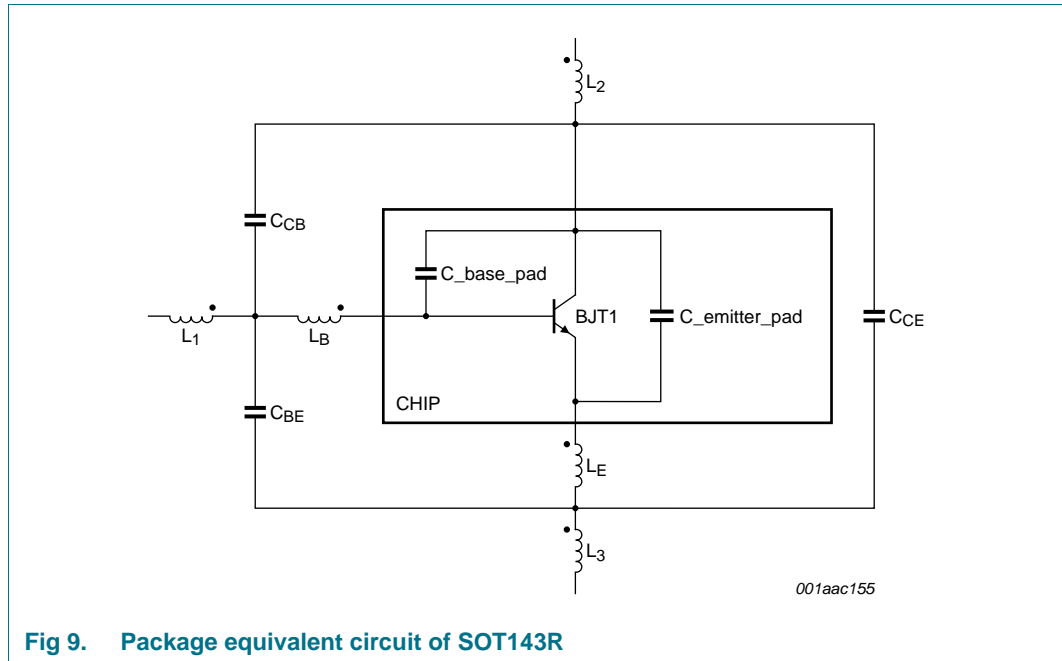
$V_{CE} = 3\text{ V}; I_C = 15\text{ mA}; Z_o = 50\ \Omega$ .

**Fig 8. Common emitter output reflection coefficient ( $s_{22}$ ); typical values**

## 8. Application information

Table 8. SPICE parameters of the BFG325 DIE

Sequence	Parameter	Value	Unit
1	IS	26.6	aA
2	BF	200	-
3	NF	1	-
4	VAF	40	V
5	IKF	105	mA
6	ISE	2.3	fA
7	NE	2.114	-
8	BR	10	-
9	NR	1	-
10	VAR	2.5	V
11	IKR	10	A
12	ISC	0	aA
13	NC	1.5	-
14	RB	3.6	$\Omega$
15	RE	1.5	$\Omega$
16	RC	2.6	$\Omega$
17	CJE	185.6	fF
18	VJE	890	mV
19	MJE	0.294	-
20	CJC	77.06	fF
21	VJC	601	mV
22	MJC	0.159	-
23	XCJC	1	-
24	FC	0.7	-
25	TF	8.1	ps
26	XTF	10	-
27	VTF	1000	V
28	ITF	150	mA
29	PTF	0	deg
30	TR	0	ns
31	KF	0	-
32	AF	1	-
33	TNOM	25	$^{\circ}\text{C}$
34	EG	1.014	eV
35	XTB	0	-
36	XTI	8	-
37	Q1.AREA	2.5	-



**Fig 9. Package equivalent circuit of SOT143R**

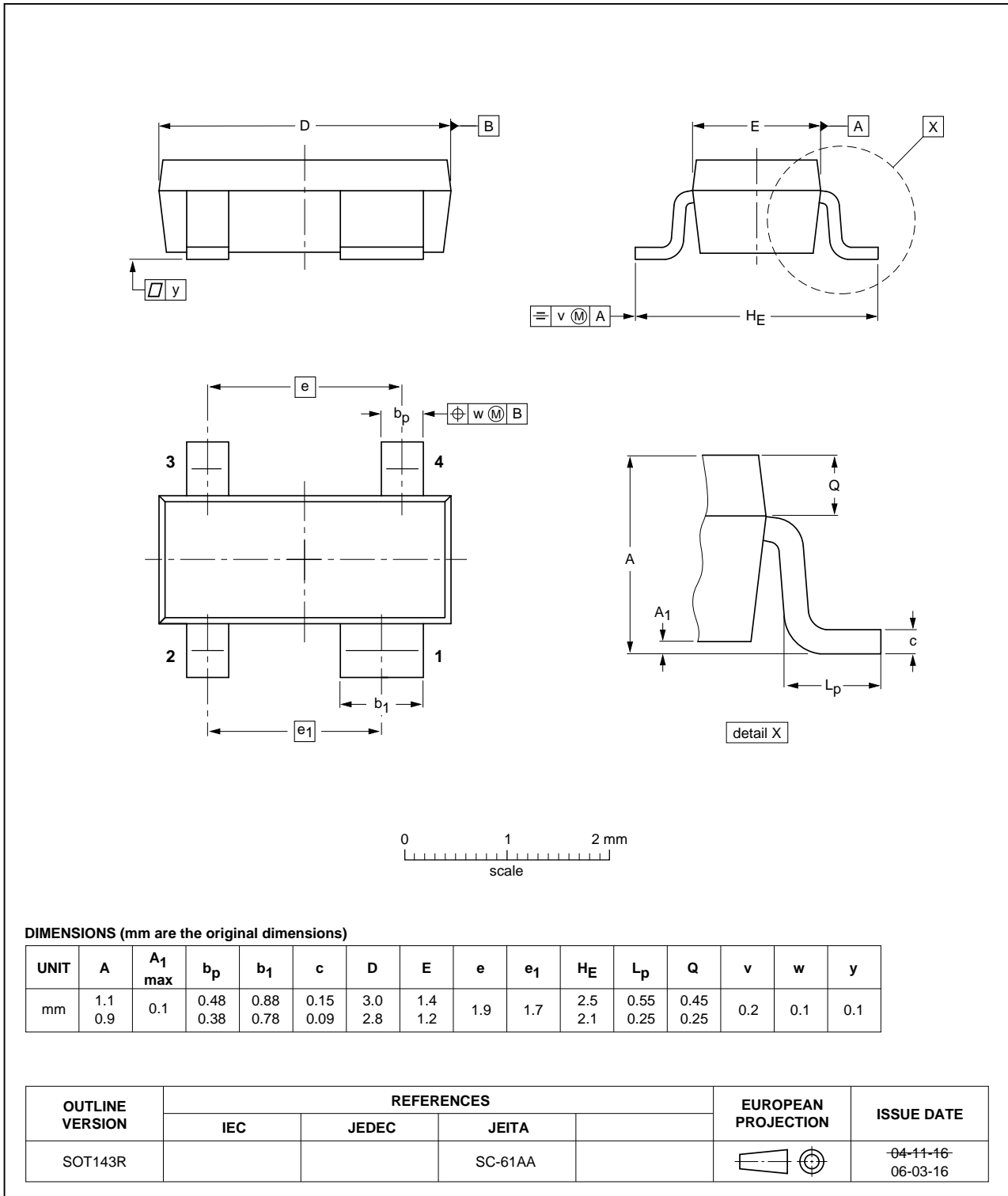
**Table 9. List of components; see [Figure 9](#)**

Designation	Value	Unit
$C_{CB}$	17	fF
$C_{BE}$	84	fF
$C_{CE}$	191	fF
$C_{base\_pad}$	67	fF
$C_{emitter\_pad}$	142	fF
$L_B$	0.95	nH
$L_E$	0.40	nH
$L_1$	0.12	nH
$L_2$	0.21	nH
$L_3$	0.06	nH

**9. Package outline**

Plastic surface-mounted package; reverse pinning; 4 leads

SOT143R



**Fig 10. Package outline SOT143R (SC-61AA)**

## 10. Revision history

Table 10. Revision history

Document ID	Release date	Data sheet status	Change notice	Supersedes
BFG325_XR v.2	20110915	Product data sheet	-	BFG325_XR v.1
Modifications:		<ul style="list-style-type: none"><li>• The format of this data sheet has been redesigned to comply with the new identity guidelines of NXP Semiconductors.</li><li>• Legal texts have been adapted to the new company name where appropriate.</li><li>• Package outline drawings have been updated to the latest version.</li></ul>		
BFG325_XR v.1 (9397 750 14247)	20050202	Product data sheet	-	-

## 11. Legal information

### 11.1 Data sheet status

Document status <sup>[1][2]</sup>	Product status <sup>[3]</sup>	Definition
Objective [short] data sheet	Development	This document contains data from the objective specification for product development.
Preliminary [short] data sheet	Qualification	This document contains data from the preliminary specification.
Product [short] data sheet	Production	This document contains the product specification.

[1] Please consult the most recently issued document before initiating or completing a design.

[2] The term 'short data sheet' is explained in section "Definitions".

[3] The product status of device(s) described in this document may have changed since this document was published and may differ in case of multiple devices. The latest product status information is available on the Internet at URL <http://www.nxp.com>.

### 11.2 Definitions

**Draft** — The document is a draft version only. The content is still under internal review and subject to formal approval, which may result in modifications or additions. NXP Semiconductors does not give any representations or warranties as to the accuracy or completeness of information included herein and shall have no liability for the consequences of use of such information.

**Short data sheet** — A short data sheet is an extract from a full data sheet with the same product type number(s) and title. A short data sheet is intended for quick reference only and should not be relied upon to contain detailed and full information. For detailed and full information see the relevant full data sheet, which is available on request via the local NXP Semiconductors sales office. In case of any inconsistency or conflict with the short data sheet, the full data sheet shall prevail.

**Product specification** — The information and data provided in a Product data sheet shall define the specification of the product as agreed between NXP Semiconductors and its customer, unless NXP Semiconductors and customer have explicitly agreed otherwise in writing. In no event however, shall an agreement be valid in which the NXP Semiconductors product is deemed to offer functions and qualities beyond those described in the Product data sheet.

### 11.3 Disclaimers

**Limited warranty and liability** — Information in this document is believed to be accurate and reliable. However, NXP Semiconductors does not give any representations or warranties, expressed or implied, as to the accuracy or completeness of such information and shall have no liability for the consequences of use of such information.

In no event shall NXP Semiconductors be liable for any indirect, incidental, punitive, special or consequential damages (including - without limitation - lost profits, lost savings, business interruption, costs related to the removal or replacement of any products or rework charges) whether or not such damages are based on tort (including negligence), warranty, breach of contract or any other legal theory.

Notwithstanding any damages that customer might incur for any reason whatsoever, NXP Semiconductors' aggregate and cumulative liability towards customer for the products described herein shall be limited in accordance with the *Terms and conditions of commercial sale* of NXP Semiconductors.

**Right to make changes** — NXP Semiconductors reserves the right to make changes to information published in this document, including without limitation specifications and product descriptions, at any time and without notice. This document supersedes and replaces all information supplied prior to the publication hereof.

**Suitability for use** — NXP Semiconductors products are not designed, authorized or warranted to be suitable for use in life support, life-critical or safety-critical systems or equipment, nor in applications where failure or

malfunction of an NXP Semiconductors product can reasonably be expected to result in personal injury, death or severe property or environmental damage. NXP Semiconductors accepts no liability for inclusion and/or use of NXP Semiconductors products in such equipment or applications and therefore such inclusion and/or use is at the customer's own risk.

**Applications** — Applications that are described herein for any of these products are for illustrative purposes only. NXP Semiconductors makes no representation or warranty that such applications will be suitable for the specified use without further testing or modification.

Customers are responsible for the design and operation of their applications and products using NXP Semiconductors products, and NXP Semiconductors accepts no liability for any assistance with applications or customer product design. It is customer's sole responsibility to determine whether the NXP Semiconductors product is suitable and fit for the customer's applications and products planned, as well as for the planned application and use of customer's third party customer(s). Customers should provide appropriate design and operating safeguards to minimize the risks associated with their applications and products.

NXP Semiconductors does not accept any liability related to any default, damage, costs or problem which is based on any weakness or default in the customer's applications or products, or the application or use by customer's third party customer(s). Customer is responsible for doing all necessary testing for the customer's applications and products using NXP Semiconductors products in order to avoid a default of the applications and the products or of the application or use by customer's third party customer(s). NXP does not accept any liability in this respect.

**Limiting values** — Stress above one or more limiting values (as defined in the Absolute Maximum Ratings System of IEC 60134) will cause permanent damage to the device. Limiting values are stress ratings only and (proper) operation of the device at these or any other conditions above those given in the Recommended operating conditions section (if present) or the Characteristics sections of this document is not warranted. Constant or repeated exposure to limiting values will permanently and irreversibly affect the quality and reliability of the device.

**Terms and conditions of commercial sale** — NXP Semiconductors products are sold subject to the general terms and conditions of commercial sale, as published at <http://www.nxp.com/profile/terms>, unless otherwise agreed in a valid written individual agreement. In case an individual agreement is concluded only the terms and conditions of the respective agreement shall apply. NXP Semiconductors hereby expressly objects to applying the customer's general terms and conditions with regard to the purchase of NXP Semiconductors products by customer.

**No offer to sell or license** — Nothing in this document may be interpreted or construed as an offer to sell products that is open for acceptance or the grant, conveyance or implication of any license under any copyrights, patents or other industrial or intellectual property rights.

**Export control** — This document as well as the item(s) described herein may be subject to export control regulations. Export might require a prior authorization from national authorities.

**Quick reference data** — The Quick reference data is an extract of the product data given in the Limiting values and Characteristics sections of this document, and as such is not complete, exhaustive or legally binding.

**Non-automotive qualified products** — Unless this data sheet expressly states that this specific NXP Semiconductors product is automotive qualified, the product is not suitable for automotive use. It is neither qualified nor tested in accordance with automotive testing or application requirements. NXP Semiconductors accepts no liability for inclusion and/or use of non-automotive qualified products in automotive equipment or applications.

In the event that customer uses the product for design-in and use in automotive applications to automotive specifications and standards, customer (a) shall use the product without NXP Semiconductors' warranty of the

product for such automotive applications, use and specifications, and (b) whenever customer uses the product for automotive applications beyond NXP Semiconductors' specifications such use shall be solely at customer's own risk, and (c) customer fully indemnifies NXP Semiconductors for any liability, damages or failed product claims resulting from customer design and use of the product for automotive applications beyond NXP Semiconductors' standard warranty and NXP Semiconductors' product specifications.

## 11.4 Trademarks

Notice: All referenced brands, product names, service names and trademarks are the property of their respective owners.

## 12. Contact information

For more information, please visit: <http://www.nxp.com>

For sales office addresses, please send an email to: [salesaddresses@nxp.com](mailto:salesaddresses@nxp.com)

## 13. Contents

<b>1</b>	<b>Product profile</b> . . . . .	<b>1</b>
1.1	General description . . . . .	1
1.2	Features and benefits . . . . .	1
1.3	Applications . . . . .	1
1.4	Quick reference data . . . . .	1
<b>2</b>	<b>Pinning information</b> . . . . .	<b>2</b>
<b>3</b>	<b>Ordering information</b> . . . . .	<b>2</b>
<b>4</b>	<b>Marking</b> . . . . .	<b>2</b>
<b>5</b>	<b>Limiting values</b> . . . . .	<b>3</b>
<b>6</b>	<b>Thermal characteristics</b> . . . . .	<b>3</b>
<b>7</b>	<b>Characteristics</b> . . . . .	<b>3</b>
<b>8</b>	<b>Application information</b> . . . . .	<b>7</b>
<b>9</b>	<b>Package outline</b> . . . . .	<b>9</b>
<b>10</b>	<b>Revision history</b> . . . . .	<b>10</b>
<b>11</b>	<b>Legal information</b> . . . . .	<b>11</b>
11.1	Data sheet status . . . . .	11
11.2	Definitions . . . . .	11
11.3	Disclaimers . . . . .	11
11.4	Trademarks . . . . .	12
<b>12</b>	<b>Contact information</b> . . . . .	<b>12</b>
<b>13</b>	<b>Contents</b> . . . . .	<b>13</b>

Please be aware that important notices concerning this document and the product(s) described herein, have been included in section 'Legal information'.

© NXP B.V. 2011.

All rights reserved.

For more information, please visit: <http://www.nxp.com>

For sales office addresses, please send an email to: [salesaddresses@nxp.com](mailto:salesaddresses@nxp.com)

Date of release: 15 September 2011

Document identifier: BFG325\_XR





## Looking for pricing, stock, or lifecycle information?

Click below to explore more details on WIN SOURCE:

 [View BFG325/XR,215 on WIN SOURCE](#)

 [NXP / Nexperia Information](#)

## Optimize Your Supply Chain with WIN SOURCE Solutions

-  Global Sourcing Solution
-  Obsolete Management
-  Cost Control Management
-  Shortage Management
-  Alternative Solution
-  Excess Inventory Management