



**THE DATASHEET OF
SG7812AIG**



Positive Fixed Voltage Regulator

Description

The SG78xxA/SG78xx series of positive regulators offer self-contained, fixed-voltage capability with up to 1.5 A of load current and input voltage up to 50 V (SG78xxA series only). These units feature a unique on-chip trimming system to set the output voltages to within $\pm 1.5\%$ of nominal on the SG78xxA series with $\pm 2.0\%$ on the SG78xx series. The SG78xxA versions also offer much improved line and load regulation characteristics. Utilizing an improved bandgap reference design, problems such as drift in output voltage and large changes in the line and load regulation, that are normally associated with the Zener diode references have been eliminated.

All protective features of thermal shutdown, current limiting, and safe-area control have been designed into these units and since these regulators require only a small output capacitor for satisfactory performance, ease of application is assured. Although designed as fixed-voltage regulators, the output voltage can be increased through the use of a simple voltage divider. The low quiescent drain current of the device ensures good regulation when this method is used. Product is available in hermetically sealed TO-257 (both case grounded 'G' and isolated 'IG'), TO-3, TO-39 and leadless chip carrier (LCC) packages.

Features

- Output Voltage Set Internally to $\pm 1.5\%$ on SG78xxA
- Input Voltage Range to 50 V max on SG78xxA
- 2 V Input-Output Differential
- Excellent Line and Load Regulation
- Fold back Current Limiting
- Thermal Overload Protection
- Voltages Available: 5 V, 12 V, 15 V
- Contact Factory for Other Voltage Options
- Available in Surface Mount Package

High Reliability Features

- Available to MIL-STD - 883, ¶ 1.2.1
- MIL-M38510/10702BXA - SG7805T-JAN
- MIL-M38510/10703BXA - SG7812T-JAN
- MIL-M38510/10704BXA - SG7815T-JAN
- MIL-M38510/10706BYA - SG7805K-JAN
- MIL-M38510/10707BYA - SG7812K-JAN
- MIL-M38510/10708BYA - SG7815K-JAN
- MSC-AMSG level "S" Processing Available
- Available to DSCC
- Standard Microcircuit Drawing (SMD)

Circuit Schematic

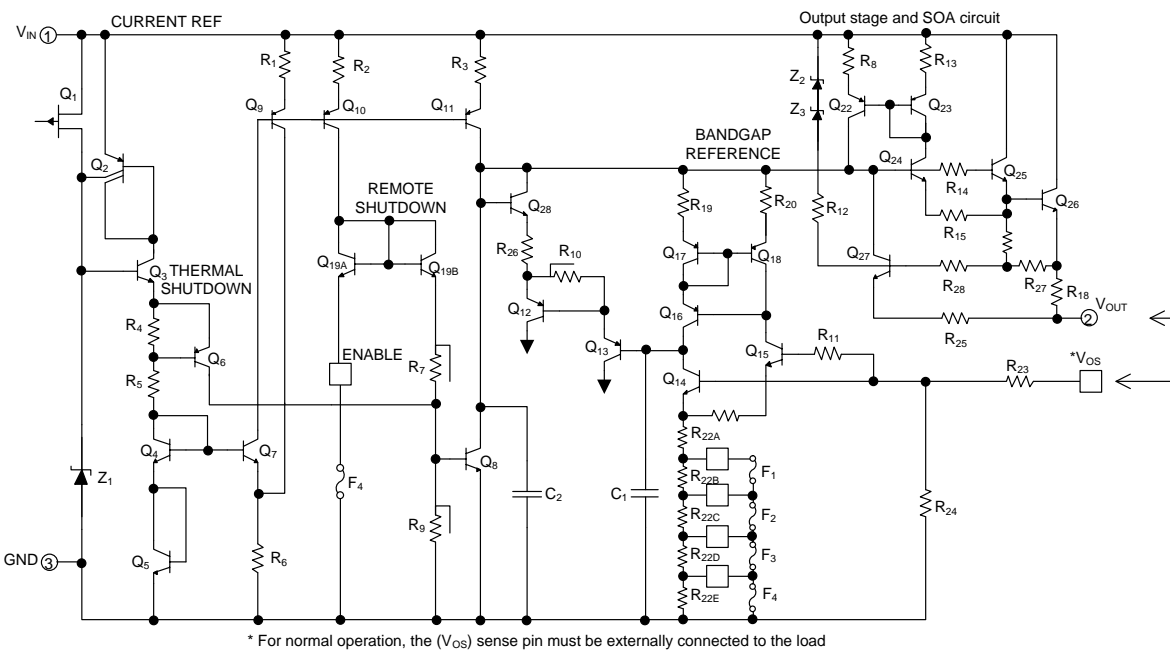

Figure 1 - Circuit Schematic

Connection Diagrams and Ordering Information

Ambient Temperature	Type	Package	Part Number	Packaging Type	Connection Diagram
-55 °C to 125 °C	K	3-Terminal Metal Can	SG78xxAK-883B	TO-3	
			SG7805AK-DESC		
			SG7812AK-DESC		
			SG7815AK-DESC		
			SG78xxAK		
			SG78xxK-883B		
			SG7805K-JAN		
			SG7812K-JAN		
			SG7815K-JAN		
			SG78xxK		
-55 °C to 125 °C	T	3-Pin Metal Can	SG78xxAT-883B	TO-39	
			SG7805AT-DESC		
			SG7812AT-DESC		
			SG7815AT-DESC		
			SG78xxAT		
			SG78xxT-883B		
			SG7805T-JAN		
			SG7812T-JAN		
			SG7815T-JAN		
			SG78xxT		
-55 °C to 125 °C	IG	3-Pin Hermetic Isolated Package	SG78xxAIG-883B	TO-257	
			SG7805AIG-DESC		
			SG7812AIG-DESC		
			SG7815AIG-DESC		
			SG78xxAIG		
			SG78xxIG-883B		
			SG78xxIG		
-55 °C to 125 °C	L	20-Pin Ceramic Package	SG7805AL-DESC	Leadless Chip Carrier	
			SG7812AL-DESC		
			SG7815AL-DESC		
			SG78xxL-883B		
-55 °C to 125 °C	G	3-Pin Hermetic Package	SG78xxAG-883B	TO-257	
			SG7805AG-DESC		
			SG7812AG-DESC		
			SG7815AG-DESC		
			SG78xxAG		
			SG78xxG-883B		
			SG78xxG		

Notes:

1. Contact factory for JAN and DESC product availability.
2. All parts are viewed from the top.
3. “xx” to be replaced by output voltage of specific fixed regulator.
4. Some products will be available in hermetic flat pack (F). Consult factory for price and availability.
5. Both inputs and outputs must be externally connected together at the device terminals.
6. For normal operation, the V_O SENSE pin must be externally connected to the load.

Absolute Maximum Ratings

Parameter	Value	Units
Device Output Voltage	5, 12, 15	V
Input Voltage	35	V
Input Voltage (Transient) (Note 2)	50	V
Input Voltage Differential (Output Shorted to Ground)	35	V
Operating Junction Temperature	150	°C
Storage Temperature Range	-65 to 150	°C
Lead Temperature (Soldering 10 seconds)	300	°C

Notes:

1. Exceeding these ratings could cause damage to the device. All voltages are with respect to Ground. Currents are positive into, negative out of specified terminal.
2. Operation at high input voltages is dependent upon load current. When load current is less than 5 mA, output will rise out of regulation as input-output differential increases beyond 30 V. Note also from [Figure 2](#), that maximum load current is reduced at high voltages. The 50 V input rating of the SG78xxA series refers to ability to withstand high line or transient conditions without damage. Since the regulator’s maximum current capability is reduced, the output may fall out of regulation at high input voltages under nominal loading.

Thermal Data

Parameter	Value	Units
K Package TO-3 3-Terminal Metal Can (Two pins and case)		
Thermal Resistance-Junction to Case, θ_{JC}	3	°C/W
Thermal Resistance-Junction to Ambient, θ_{JA}	35	°C/W
T Package TO-39 3-Pin Metal Can		
Thermal Resistance-Junction to Case, θ_{JC}	15	°C/W
Thermal Resistance-Junction to Ambient, θ_{JA}	120	°C/W
G Package TO-257 3-Pin Hermetic		
Thermal Resistance-Junction to Case, θ_{JC}	3.5	°C/W
Thermal Resistance-Junction to Ambient, θ_{JA}	42	°C/W
IG Package TO-257 3-Pin Hermetic (Isolated)		
Thermal Resistance-Junction to Case, θ_{JC}	4	°C/W
Thermal Resistance-Junction to Ambient, θ_{JA}	42	°C/W
L Package Leadless Chip Carrier 20-Pin Ceramic		
Thermal Resistance-Junction to Case, θ_{JC}	35	°C/W
Thermal Resistance-Junction to Ambient, θ_{JA}	120	°C/W
<i>Notes:</i>		
1. Junction Temperature Calculation: $T_J = T_A + (P_D \times \theta_{JA})$.		
2. The θ_{JA} numbers are meant to be guidelines for the thermal performance of the device/pc-board system. All of the above assume no ambient airflow.		

Recommended Operating Conditions

Parameter	SG78xx / 78xxA			Units
	Min	Typ	Max	
Operating Junction Temperature Range	-55		150	°C
<i>Note: Range over which the device is functional.</i>				

Electrical Characteristics

Unless specified, these specifications apply over the operating ambient temperatures for SG7805A / SG7805 with $-55\text{ }^{\circ}\text{C} \leq T_A \leq 125\text{ }^{\circ}\text{C}$, $V_{IN} = 10\text{ V}$, $I_O = 500\text{ mA}$ for the K, G, and IG – Power Packages, $I_O = 100\text{ mA}$ for the T and L packages, $C_{IN} = 0.33\text{ }\mu\text{F}$ and $C_{OUT} = 0.1\text{ }\mu\text{F}$. Low duty cycle pulse testing techniques are used, which maintains junction and case temperatures equal to the ambient temperature.

Parameter	Test Conditions	SG7805A			SG7805			Units
		Min	Typ	Max	Min	Typ	Max	
Output Voltage	$T_J = 25\text{ }^{\circ}\text{C}$	4.92	5	5.08	4.80	5	5.20	V
Line Regulation (Note 1)	$V_{IN} = 7.5\text{ V to } 20\text{ V}$, $T_J = 25\text{ }^{\circ}\text{C}$		5	25		5	25	mV
	$V_{IN} = 8\text{ V to } 12\text{ V}$, $T_J = 25\text{ }^{\circ}\text{C}$		2	12		2	25	mV
Load Regulation (Note 1)	Power Pkgs: $I_O = 5\text{ mA to } 1.5\text{ A}$, $T_J = 25\text{ }^{\circ}\text{C}$		15	50		15	50	mV
	$I_O = 250\text{ mA to } 750\text{ mA}$, $T_J = 25\text{ }^{\circ}\text{C}$		5	25		5	25	mV
	T, L – Pkg: $I_O = 5\text{ mA to } 500\text{ mA}$, $T_J = 250\text{ }^{\circ}\text{C}$		5	25		20	25	mV
Total Output Voltage Tolerance	$V_{IN} = 8\text{ V to } 20\text{ V}$ Power Pkgs: $I_O = 5\text{ mA to } 1.0\text{ A}$, $P \leq 20\text{ W}$	4.85	5	5.15	4.65	5	5.35	V
	$V_{IN} = 8\text{ V to } 20\text{ V}$ T, L – Pkg: $I_O = 5\text{ mA to } 500\text{ mA}$, $P \leq 2\text{ W}$	4.85	5	5.15	4.65	5	5.35	V
Quiescent Current	Over Temperature Range			7			7	mA
	$T_J = 25\text{ }^{\circ}\text{C}$		4	6		4	6	mA
Quiescent Current Change	With Line: $V_{IN} = 8\text{ V to } 25\text{ V}$			0.8			0.8	mA
	With Load: $I_O = 5\text{ mA to } 1.0\text{ A}$ (Power Pkgs)			0.5			0.5	mA
	$I_O = 5\text{ mA to } 500\text{ mA}$ (T, L)			0.5			0.5	mA
Dropout Voltage	$\Delta V_O = 100\text{ mV}$, $T_J = 25\text{ }^{\circ}\text{C}$ Power Pkgs: $I_O = 1.0\text{ A}$, T, L -Pkg: $I_O = 500\text{ mA}$		2	2.5		2	2.5	V
Peak Output Current	Power Pkgs: $V_{IN} = 10\text{ V}$, $T_J = 25\text{ }^{\circ}\text{C}$	1.5	2	3.3	1.5	2	3.3	A
	T, L – Pkg: $V_{IN} = 10\text{ V}$, $T_J = 25\text{ }^{\circ}\text{C}$	0.5	1	2	0.5	1	2	A
Short Circuit Current	Power Pkgs: $V_{IN} = 35\text{ V}$, $T_J = 25\text{ }^{\circ}\text{C}$			1.2			1.2	A
	T, L – Pkg: $V_{IN} = 35\text{ V}$, $T_J = 25\text{ }^{\circ}\text{C}$			0.7			0.7	A
Ripple Rejection	$\Delta V_{IN} = 10\text{ V}$, $f = 120\text{ Hz}$, $T_J = 25\text{ }^{\circ}\text{C}$	68			68			dB
Output Noise Voltage (rms)	$f = 10\text{ Hz to } 100\text{ kHz}$ (Note 2)			40			40	$\mu\text{V/V}$
Long Term Stability	1000 hours @ $T_J = 125\text{ }^{\circ}\text{C}$		20			20		mV
Thermal Shutdown	$I_O = 5\text{ mA}$		175			175		$^{\circ}\text{C}$

Notes:

- All regulation tests are made at constant junction temperature with low duty cycle testing.
- This test is guaranteed but is not tested in production.

Electrical Characteristics

Unless specified, these specifications apply over the operating ambient temperatures for SG7812A / SG7812 with $-55\text{ °C} \leq T_A \leq 125\text{ °C}$, $V_{IN} = 19\text{ V}$, $I_O = 500\text{ mA}$ for the K, G, and IG – Power Packages, $I_O = 100\text{ mA}$ for the T and L packages, $C_{IN} = 0.33\text{ }\mu\text{F}$ and $C_{OUT} = 0.1\text{ }\mu\text{F}$. Low duty cycle pulse testing techniques are used, which maintains junction and case temperatures equal to the ambient temperature.

Parameter	Test Conditions	SG7812A			SG7812			Units
		Min	Typ	Max	Min	Typ	Max	
Output Voltage	$T_J = 25\text{ °C}$	11.8	12	12.2	11.5	12	12.5	V
Line Regulation (Note 1)	$V_{IN} = 14.5\text{ V to }30\text{ V}$, $T_J = 25\text{ °C}$		12	60		12	120	mV
	$V_{IN} = 16\text{ V to }22\text{ V}$, $T_J = 25\text{ °C}$		6	30		6	60	mV
Load Regulation (Note 1)	Power Pkgs: $I_O = 5\text{ mA to }1.5\text{ A}$, $T_J = 25\text{ °C}$		28	80		28	120	mV
	$I_O = 250\text{ mA to }750\text{ mA}$, $T_J = 25\text{ °C}$		10	40		10	60	mV
	T, L – Pkg: $I_O = 5\text{ mA to }500\text{ mA}$, $T_J = 25\text{ °C}$		10	40		10	60	mV
Total Output Voltage Tolerance	$V_{IN} = 15.5\text{ V to }27\text{ V}$ Power Pkgs: $I_O = 5\text{ mA to }1.0\text{ A}$, $P \leq 20\text{ W}$	11.7	12	12.3	11.4	12	12.6	V
	$V_{IN} = 15.5\text{ V to }27\text{ V}$ T, L – Pkg: $I_O = 5\text{ mA to }500\text{ mA}$, $P \leq 2\text{ W}$	11.7	12	12.3	11.4	12	12.6	V
Quiescent Current	Over Temperature Range			7			7	mA
	$T_J = 25\text{ °C}$		4	6		4	6	mA
Quiescent Current Change	With Line: $V_{IN} = 15\text{ V to }30\text{ V}$			0.8			0.8	mA
	With Load: $I_O = 5\text{ mA to }1.0\text{ A}$ (Power Pkgs)			0.5			0.5	mA
	$I_O = 5\text{ mA to }500\text{ mA}$ (T, L)			0.5			0.5	mA
Dropout Voltage	$\Delta V_O = 100\text{ mV}$, $T_J = 25\text{ °C}$ Power Pkgs: $I_O = 1.0\text{ A}$, T, L – Pkg: $I_O = 500\text{ mA}$		2	2.5		2	2.5	V
Peak Output Current	Power Pkgs: $T_J = 25\text{ °C}$	1.5	2	3.3	1.5	2	3.3	A
	T, L – Pkg: $T_J = 25\text{ °C}$	0.5	1	1.7	0.5	1	1.7	A
Short Circuit Current	Power Pkgs: $V_{IN} = 35\text{ V}$, $T_J = 25\text{ °C}$			1.2			1.2	A
	T, L – Pkg: $V_{IN} = 35\text{ V}$, $T_J = 25\text{ °C}$			0.7			0.7	A
Ripple Rejection	$\Delta V_{IN} = 10\text{ V}$, $f = 120\text{ Hz}$, $T_J = 25\text{ °C}$	61			61			dB
Output Noise Voltage (rms)	$f = 10\text{ Hz to }100\text{ kHz}$ (Note 2)			40			40	$\mu\text{V/V}$
Long Term Stability	1000 hours @ $T_J = 125\text{ °C}$		48			48		mV
Thermal Shutdown	$I_O = 5\text{ mA}$		175			175		$^{\circ}\text{C}$

Notes:

- All regulation tests are made at constant junction temperature with low duty cycle testing.
- This test is guaranteed but is not tested in production.

Electrical Characteristics

Unless specified, these specifications apply over the operating ambient temperatures for SG7815A / SG7815 with $-55\text{ }^{\circ}\text{C} \leq T_A \leq 125\text{ }^{\circ}\text{C}$, $V_{IN} = 23\text{ V}$, $I_O = 500\text{ mA}$ for the K, G, and IG – Power Packages, $I_O = 100\text{ mA}$ for the T and L packages, $C_{IN} = 0.33\text{ }\mu\text{F}$ and $C_{OUT} = 0.1\text{ }\mu\text{F}$. Low duty cycle pulse testing techniques are used which maintains junction and case temperatures equal to the ambient temperature.

Parameter	Test Conditions	SG7815A			SG7815			Units
		Min	Typ	Max	Min	Typ	Max	
Output Voltage	$T_J = 25\text{ }^{\circ}\text{C}$	14.8	15	15.2	14.4	15	15.6	V
Line Regulation (Note 1)	$V_{IN} = 17.5\text{ V to }30\text{ V}$, $T_J = 25\text{ }^{\circ}\text{C}$		15	75		15	150	mV
	$V_{IN} = 20\text{ V to }26\text{ V}$, $T_J = 25\text{ }^{\circ}\text{C}$		8	40		8	75	mV
Load Regulation (Note 1)	Power Pkgs: $I_O = 5\text{ mA to }1.5\text{ A}$, $T_J = 25\text{ }^{\circ}\text{C}$		30	100		30	150	mV
	$I_O = 250\text{ mA to }750\text{ mA}$, $T_J = 25\text{ }^{\circ}\text{C}$		12	50		12	75	mV
	T, L – Pkg: $I_O = 5\text{ mA to }500\text{ mA}$, $T_J = 25\text{ }^{\circ}\text{C}$		12	50		12	75	mV
Total Output Voltage Tolerance	$V_{IN} = 18.5\text{ V to }30\text{ V}$ Power Pkgs: $I_O = 5\text{ mA to }1.0\text{ A}$, $P \leq 20\text{ W}$	14.6	15	15.4	14.3	15	15.7	V
	$V_{IN} = 18.5\text{ V to }30\text{ V}$ T, L – Pkg: $I_O = 5\text{ mA to }500\text{ mA}$, $P \leq 2\text{ W}$	14.6	15	15.4	14.3	15	15.7	V
Quiescent Current	Over Temperature Range			7			7	mA
	$T_J = 25\text{ }^{\circ}\text{C}$		4	6		4	6	mA
Quiescent Current Change	With Line: $V_{IN} = 18.5\text{ V to }30\text{ V}$			0.8			0.8	mA
	With Load: $I_O = 5\text{ mA to }1.0\text{ A}$ (Power Pkgs)			0.5			0.5	mA
	$I_O = 5\text{ mA to }500\text{ mA}$ (T, L)			0.5			0.5	mA
Dropout Voltage	$\Delta V_O = 100\text{ mV}$, $T_J = 25\text{ }^{\circ}\text{C}$ Power Pkgs: $I_O = 1.0\text{ A}$, T, L – Pkg: $I_O = 500\text{ mA}$		2	2.5		2	2.5	V
Peak Output Current	Power Pkgs: $T_J = 25\text{ }^{\circ}\text{C}$	1.5	2.2	3.3	1.5	2.2	3.3	A
	T, L – Pkg: $T_J = 25\text{ }^{\circ}\text{C}$	0.5	0.9	1.7	0.5	0.9	1.7	A
Short Circuit Current	Power Pkgs: $V_{IN} = 35\text{ V}$, $T_J = 25\text{ }^{\circ}\text{C}$			1.2			1.2	A
	T, L – Pkg: $V_{IN} = 35\text{ V}$, $T_J = 25\text{ }^{\circ}\text{C}$			0.7			0.7	A
Ripple Rejection	$\Delta V_{IN} = 10\text{ V}$, $f = 120\text{ Hz}$, $T_J = 25\text{ }^{\circ}\text{C}$	60			60			dB
Output Noise Voltage (rms)	$f = 10\text{ Hz to }100\text{ kHz}$ (Note 2)			40			40	$\mu\text{V/V}$
Long Term Stability	1000 hours @ $T_J = 125\text{ }^{\circ}\text{C}$		60			60		mV
Thermal Shutdown	$I_O = 5\text{ mA}$		175			175		$^{\circ}\text{C}$

Notes:

- All regulation tests are made at constant junction temperature with low duty cycle testing.
- This test is guaranteed but is not tested in production.

Characteristic Curves

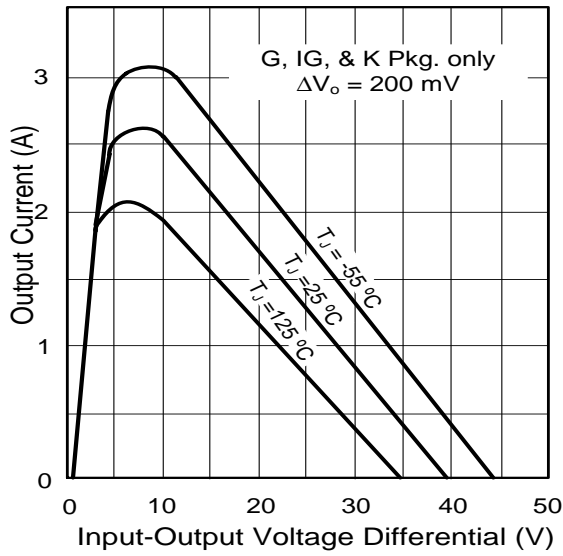

Figure 2 - Peak Output Current versus Input-Output Differential

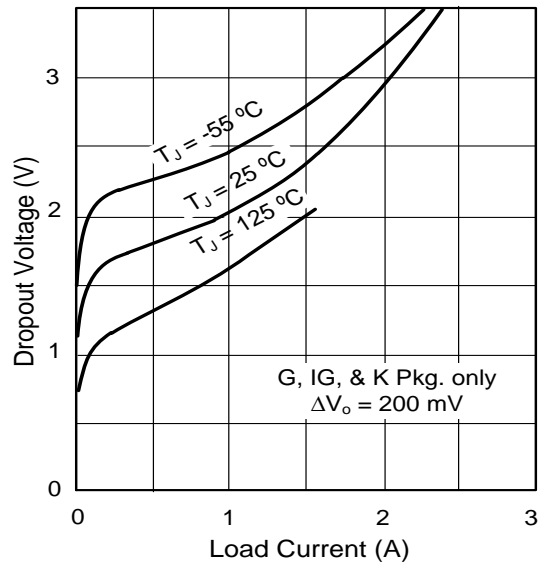

Figure 3 - Minimum Input-Output Voltage versus Load Current

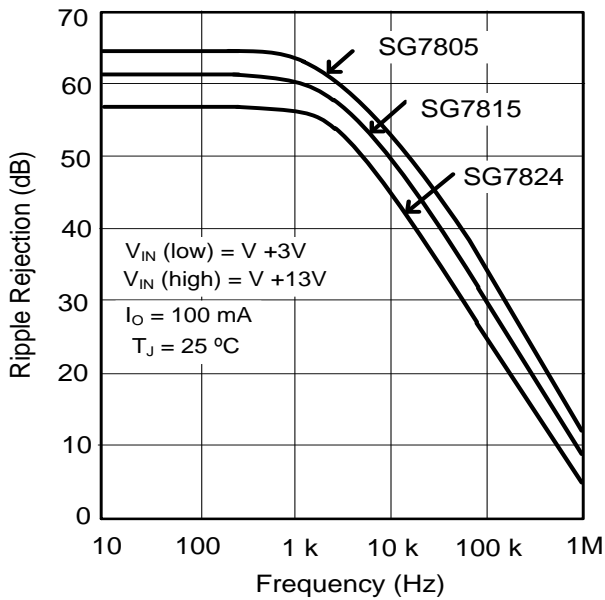
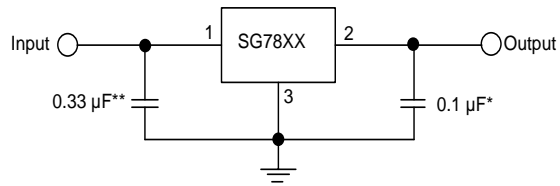

Figure 4 - Ripple Rejection versus Frequency

Application Information



* Increasing value of output capacitor improves system transient response

**Required only if regulator is located an appreciable distance from power supply filter

Figure 5 - Fixed Output Regulator



Figure 6 - Circuit for Increasing Output Voltage



Figure 7 - High Output Current, Short Circuit Protected



Figure 8 - Adjustable Output Regulator, 7 V to 30 V

Package Outline Dimensions

Controlling dimensions are in inches, metric equivalents are shown for general information.



Dim	MILLIMETERS		INCHES	
	MIN	MAX	MIN	MAX
A	6.86	7.62	0.270	0.300
q	29.90	30.40	1.177	1.197
b	0.97	1.09	0.038	0.043
D	19.43	19.68	0.765	0.775
S	16.64	17.14	0.655	0.675
e	10.67	11.18	0.420	0.440
e1	5.21	5.72	0.205	0.225
F	1.52	2.03	0.060	0.080
ϕ_p	3.84	4.09	0.151	0.161
L	10.79	12.19	0.425	0.480
R1	3.33	4.78	0.131	0.188
R	12.57	13.34	0.495	0.525

Note: Dimensions do not include protrusions; these shall not exceed 0.155 mm (0.006") on any side. Lead dimension shall not include solder coverage.

Figure 9 - K 3-Pin Metal Can TO-3



Dim	MILLIMETERS		INCHES	
	MIN	MAX	MIN	MAX
A	4.19	4.70	0.165	0.185
b	0.41	0.48	0.016	0.019
b1	0.41	0.53	0.016	0.021
D	8.89	9.40	0.350	0.370
D1	8.13	8.51	0.320	0.335
e	5.08 BSC		0.200 BSC	
e1	2.54 Typ		0.100 Typ	
F	-	1.02	-	0.040
k	0.71	0.86	0.028	0.034
k1	0.74	1.14	0.029	0.045
L	12.70	14.48	0.500	0.570
L1	-	1.27	-	0.050
Q	90° Typ		90° Typ	
α	45° Typ		45° Typ	

* Lead Coplanarity

Note: Dimensions do not include protrusions; these shall not exceed 0.155 mm (0.006") on any side. Lead dimension shall not include solder coverage.

Figure 10 - T 3-Pin Metal Can TO-39

Package Outline Dimensions (continued)



Dim	MILLIMETERS		INCHES	
	MIN	MAX	MIN	MAX
A	4.70	5.21	0.185	0.205
A1	0.89	1.14	0.035	0.045
A2	2.92	3.18	0.115	0.125
b	0.71	0.081	0.027	0.032
D	16.38	16.76	0.645	0.660
D1*	10.41	10.92	0.410	0.430
e	2.54 BSC		0.100 BSC	
E*	10.41	10.67	0.410	0.420
H		0.50		0.020
L	12.70		0.500	
O	13.39	13.64	0.527	0.537
P	3.56	3.81	0.140	0.150
J		0.10		0.004
V	5.13	5.38	0.202	0.212
Z	1.40 Typ		0.055 Typ	

*Excludes Weld Fillet Around Lid.

Note: Dimensions do not include protrusions; these shall not exceed 0.155 mm (0.006") on any side. Lead dimension shall not include solder coverage.

Figure 11 • G/IG 3-Pin Hermetic TO-257



Dim	MILLIMETERS		INCHES	
	MIN	MAX	MIN	MAX
D, E	8.64	9.14	0.340	0.360
E3	-	8.128	-	0.320
e	1.270 BSC		0.050 BSC	
B1	0.635 Typ		0.025 Typ	
L	1.02	1.52	0.040	0.060
A	1.626	2.286	0.064	0.090
h	1.016 Typ		0.040 Typ	
A1	1.372	1.68	0.054	0.066
A2	-	1.168	-	0.046
L2	1.91	2.41	0.075	0.95
B3	0.203R		0.008R	

Note: All exposed metalized area shall be gold plated 60 μ-inch minimum thickness over nickel plated unless specified in purchase order. Lead dimension shall not include solder coverage

Figure 12 • L 20-Pin Ceramic Leadless Chip Carrier



Microsemi Corporate Headquarters
One Enterprise, Aliso Viejo,
CA 92656 USA

Within the USA: +1 (800) 713-4113
Outside the USA: +1 (949) 380-6100
Sales: +1 (949) 380-6136
Fax: +1 (949) 215-4996

E-mail: sales.support@microsemi.com



© 2015 Microsemi Corporation. All rights reserved. Microsemi and the Microsemi logo are trademarks of Microsemi Corporation. All other trademarks and service marks are the property of their respective owners.

Microsemi Corporation (Nasdaq: MSCC) offers a comprehensive portfolio of semiconductor and system solutions for communications, defense & security, aerospace and industrial markets. Products include high-performance and radiation-hardened analog mixed-signal integrated circuits, FPGAs, SoCs and ASICs; power management products; timing and synchronization devices and precise time solutions, setting the world's standard for time; voice processing devices; RF solutions; discrete components; security technologies and scalable anti-tamper products; Power-over-Ethernet ICs and midspans; as well as custom design capabilities and services. Microsemi is headquartered in Aliso Viejo, Calif., and has approximately 3,400 employees globally. Learn more at www.microsemi.com.

Microsemi makes no warranty, representation, or guarantee regarding the information contained herein or the suitability of its products and services for any particular purpose, nor does Microsemi assume any liability whatsoever arising out of the application or use of any product or circuit. The products sold hereunder and any other products sold by Microsemi have been subject to limited testing and should not be used in conjunction with mission-critical equipment or applications. Any performance specifications are believed to be reliable but are not verified, and Buyer must conduct and complete all performance and other testing of the products, alone and together with, or installed in, any end-products. Buyer shall not rely on any data and performance specifications or parameters provided by Microsemi. It is the Buyer's responsibility to independently determine suitability of any products and to test and verify the same. The information provided by Microsemi hereunder is provided "as is, where is" and with all faults, and the entire risk associated with such information is entirely with the Buyer. Microsemi does not grant, explicitly or implicitly, to any party any patent rights, licenses, or any other IP rights, whether with regard to such information itself or anything described by such information. Information provided in this document is proprietary to Microsemi, and Microsemi reserves the right to make any changes to the information in this document or to any products and services at any time without notice.

Looking for pricing, stock, or lifecycle information?

Click below to explore more details on WIN SOURCE:

-  [View SG7812AIG on WIN SOURCE](#)
-  [Microchip Technology](#) Information

Optimize Your Supply Chain with WIN SOURCE Solutions

-  Global Sourcing Solution
-  Obsolete Management
-  Cost Control Management
-  Shortage Management
-  Alternative Solution
-  Excess Inventory Management