

NPN Silicon RF Transistor
Preliminary data

- For low noise, high-gain broadband amplifiers at collector currents from 1 mA to 20 mA
- $f_T = 9$ GHz
 $F = 1.0$ dB at 1 GHz

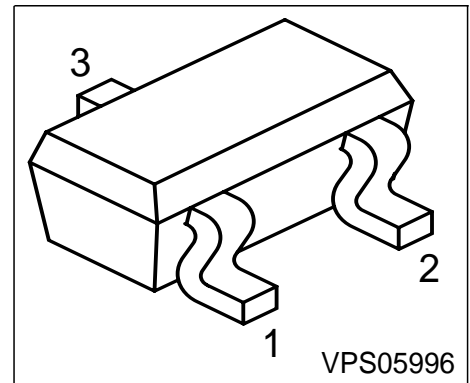

ESD: Electrostatic discharge sensitive device, observe handling precaution!

Type	Marking	Pin Configuration			Package
BFR949T	RKs	1 = B	2 = E	3 = C	SC75

Maximum Ratings

Parameter	Symbol	Value	Unit
Collector-emitter voltage	V_{CEO}	10	V
Collector-emitter voltage	V_{CES}	20	
Collector-base voltage	V_{CBO}	20	
Emitter-base voltage	V_{EBO}	1.5	
Collector current	I_C	35	mA
Base current	I_B	4	
Total power dissipation $T_S \leq 75^\circ\text{C}^1)$	P_{tot}	250	mW
Junction temperature	T_j	150	°C
Ambient temperature	T_A	-65 ... 150	
Storage temperature	T_{stg}	-65 ... 150	

Thermal Resistance

Junction - soldering point ²⁾	R_{thJS}	≤ 300	K/W
--	------------	------------	-----

¹ T_S is measured on the collector lead at the soldering point to the pcb

²For calculation of R_{thJA} please refer to Application Note Thermal Resistance

Electrical Characteristics at $T_A = 25^\circ\text{C}$, unless otherwise specified

Parameter	Symbol	Values			Unit
		min.	typ.	max.	
DC Characteristics					
Collector-emitter breakdown voltage $I_C = 1 \text{ mA}, I_B = 0$	$V_{(BR)CEO}$	10	-	-	V
Base-emitter forward voltage $I_E = 25\text{mA}$	V_{BEF}	-	-	1.05	
Collector-base cutoff current $V_{CB} = 10 \text{ V}, I_E = 0$	I_{CBO}	-	-	100	nA
Emitter-base cutoff current $V_{EB} = 1 \text{ V}, I_C = 0$	I_{EBO}	-	-	0.1	μA
DC current gain $I_C = 5 \text{ mA}, V_{CE} = 6 \text{ V}$	h_{FE}	100	140	200	-

Electrical Characteristics at $T_A = 25^\circ\text{C}$, unless otherwise specified.

Parameter	Symbol	Values			Unit
		min.	typ.	max.	
AC characteristics (verified by random sampling)					
Transition frequency $I_C = 15 \text{ mA}, V_{CE} = 6 \text{ V}, f = 1 \text{ GHz}$	f_T	7	9	-	GHz
Collector-base capacitance $V_{CB} = 10 \text{ V}, f = 1 \text{ MHz}$	C_{cb}	-	0.33	0.4	pF
Collector-emitter capacitance $V_{CE} = 10 \text{ V}, f = 1 \text{ MHz}$	C_{ce}	-	0.2	-	
Emitter-base capacitance $V_{EB} = 0.5 \text{ V}, f = 1 \text{ MHz}$	C_{eb}	-	0.6	-	
Noise figure $I_C = 5 \text{ mA}, V_{CE} = 6 \text{ V}, Z_S = Z_{Sopt}, f = 1 \text{ GHz}$ $I_C = 3 \text{ mA}, V_{CE} = 8 \text{ V}, Z_S = Z_{Sopt}, f = 1.8 \text{ GHz}$	F	-	1 1.5	2.5 -	dB
Power gain, maximum stable ¹⁾ $I_C = 10 \text{ mA}, V_{CE} = 8 \text{ V}, Z_S = Z_{Sopt}, Z_L = Z_{Lopt}, f = 900 \text{ MHz}$	G_{ms}	-	20	-	
Power gain, maximum available ²⁾ $I_C = 10 \text{ mA}, V_{CE} = 8 \text{ V}, Z_S = Z_{Sopt}, Z_L = Z_{Lopt}, f = 1.8 \text{ GHz}$	G_{ma}	-	14	-	
Transducer gain $I_C = 15 \text{ mA}, V_{CE} = 6 \text{ V}, Z_S = Z_L = 50\Omega, f = 1 \text{ GHz}$ $I_C = 10 \text{ mA}, V_{CE} = 8 \text{ V}, Z_S = Z_L = 50\Omega, f = 1.8 \text{ GHz}$	$ S_{21e} ^2$	13 -	16 11	- -	

$$^1G_{ms} = |S_{21} / S_{12}|$$

$$^2G_{ma} = |S_{21} / S_{12}| (k - (k^2 - 1)^{1/2})$$

SPICE Parameters (Gummel-Poon Model, Berkley-SPICE 2G.6 Syntax) :

Transistor Chip Data

IS =	4.36	fA	BF =	120	-	NF =	1.085	-
VAF =	30	V	IKF =	0.152	A	ISE =	1.86	pA
NE =	1.998	-	BR =	33.322	-	NR =	1.095	-
VAR =	41.889	V	IKR =	0.063	A	ISC =	3.68	pA
NC =	1.569	-	RB =	20.766	Ω	IRB =	72.2	μ A
RBM =	0.823	Ω	RE =	0.101		RC =	0.849	Ω
CJE =	291	fF	VJE =	0.586	V	MJE =	0.456	-
TF =	8.77	ps	XTF =	0.00894	-	VTF =	0.198	V
ITF =	1.336	mA	PTF =	0	deg	CJC =	459	fF
VJC =	1.048	V	MJC =	0.334	-	XCJC =	0.217	-
TR =	1.39	ns	CJS =	0	fF	VJS =	0.75	V
MJS =	0	-	NK =	0.5	-	EG =	1.11	eV
.	-		FC =	0.924	-	TNOM	300	K

All parameters are ready to use, no scaling is necessary.
 Extracted on behalf of Infineon Technologies AG by:
 Institut für Mobil-und Satellitentechnik (IMST)

Package Equivalent Circuit:

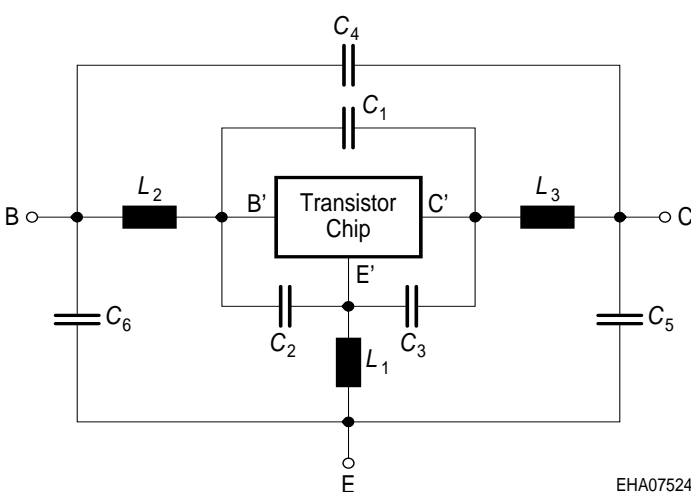

$L_1 =$	0.762	nH
$L_2 =$	0.706	nH
$L_3 =$	0.382	nH
$C_1 =$	62	fF
$C_2 =$	84	fF
$C_3 =$	180	fF
$C_4 =$	7	fF
$C_5 =$	40	fF
$C_6 =$	48	fF

Valid up to 6GHz

For examples and ready to use parameters please contact your local Infineon Technologies distributor or sales office to obtain a Infineon Technologies CD-ROM or see Internet: <http://www.infineon.com/silicondiscretes>

Total power dissipation $P_{tot} = f(T_S)$

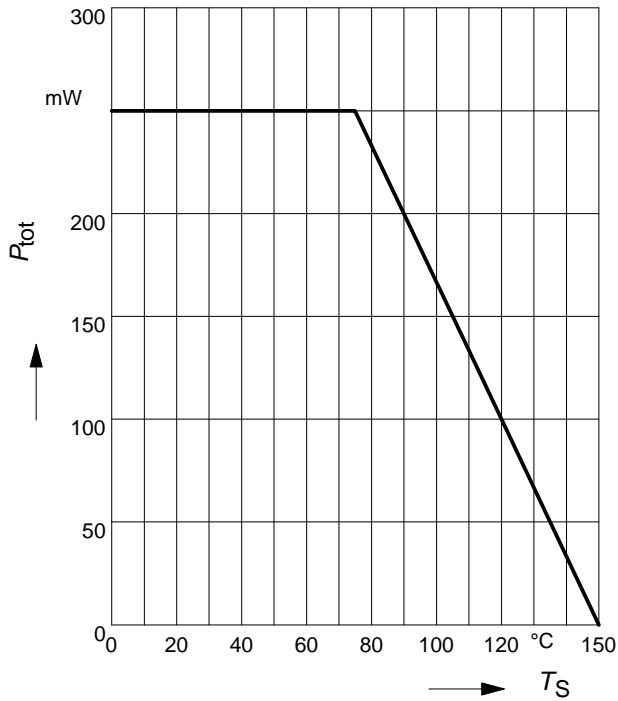

Permissible Pulse Load $R_{thJS} = f(t_p)$

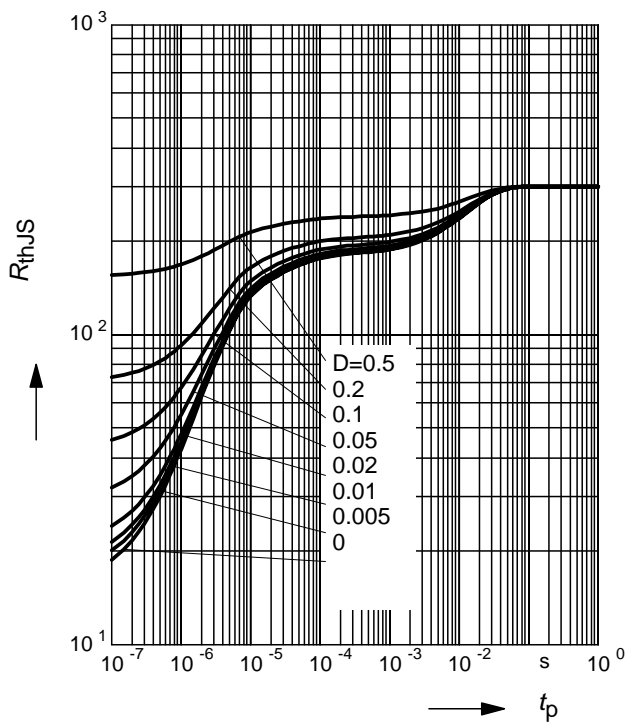

Permissible Pulse Load

$P_{totmax}/P_{totDC} = f(t_p)$

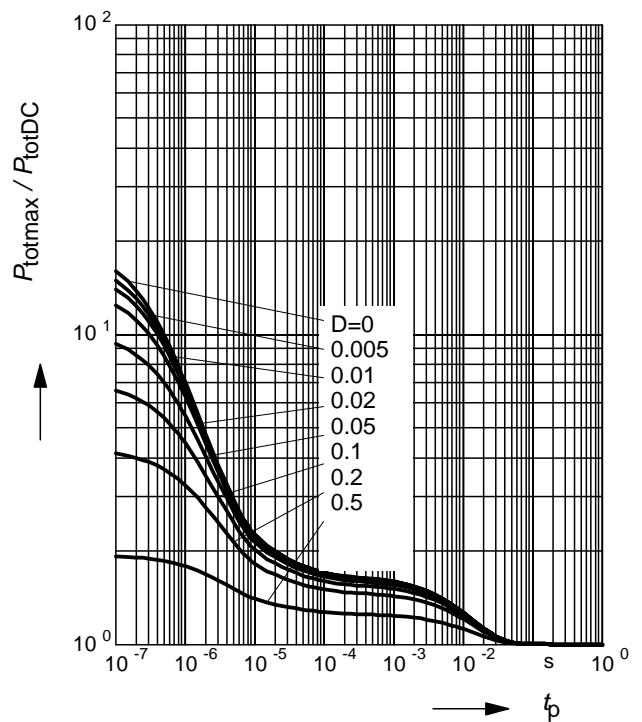

Collector-base capacitance $C_{cb} = f(V_{CB})$

$f = 1\text{MHz}$

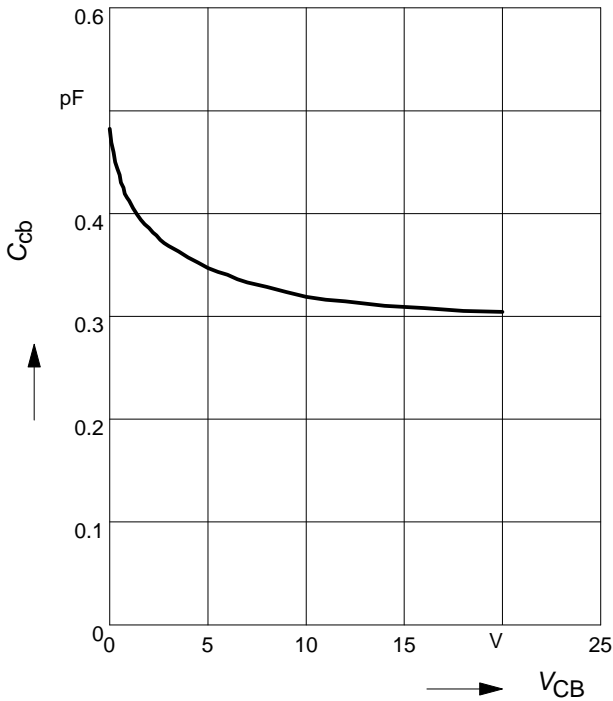

Transition frequency $f_T = f(I_C)$

$V_{CE} = \text{Parameter}$

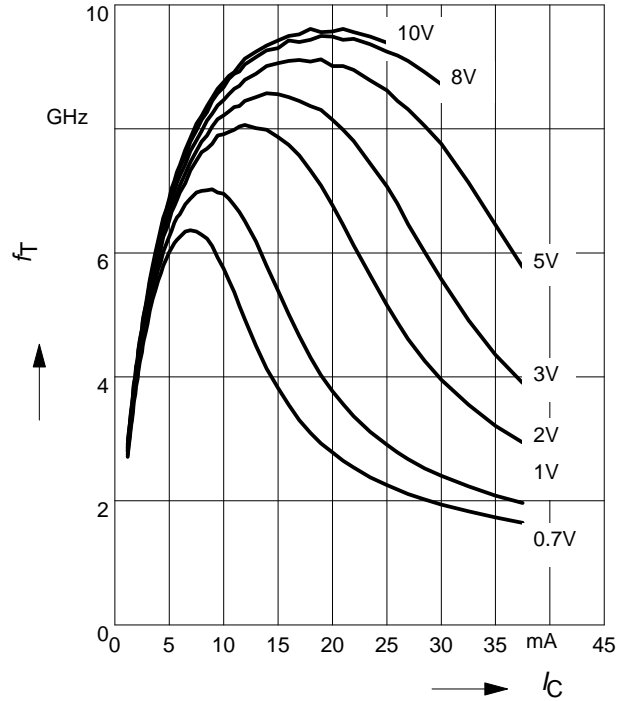

Power Gain $G_{ma}, G_{ms} = f(I_C)$

$f = 0.9\text{GHz}$

$V_{CE} = \text{Parameter}$

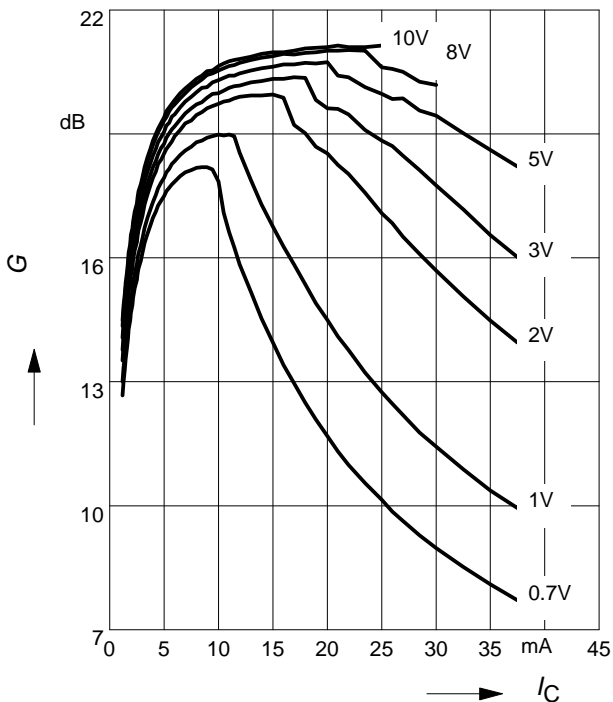

Power Gain $G_{ma}, G_{ms} = f(I_C)$

$f = 1.8\text{GHz}$

$V_{CE} = \text{Parameter}$

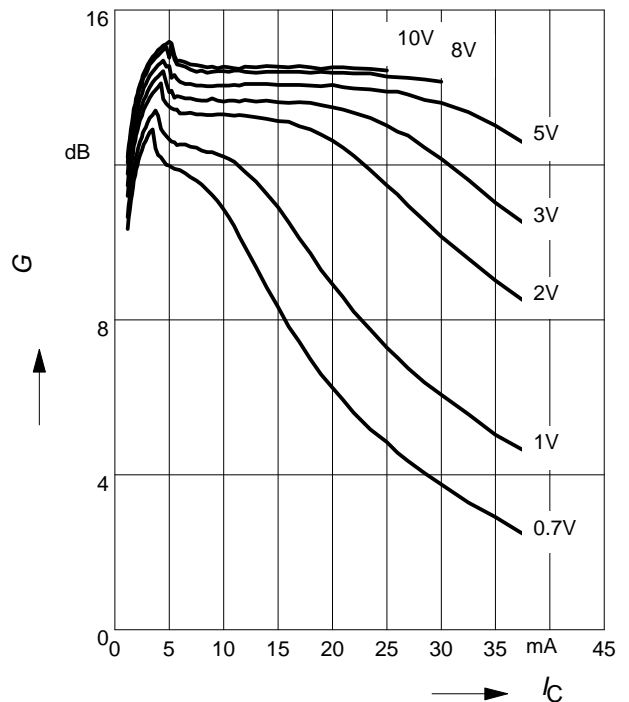

Power Gain G_{ma} , $G_{ms} = f(V_{CE})$: _____
 $|S_{21}|^2 = f(V_{CE})$: -----

f = Parameter

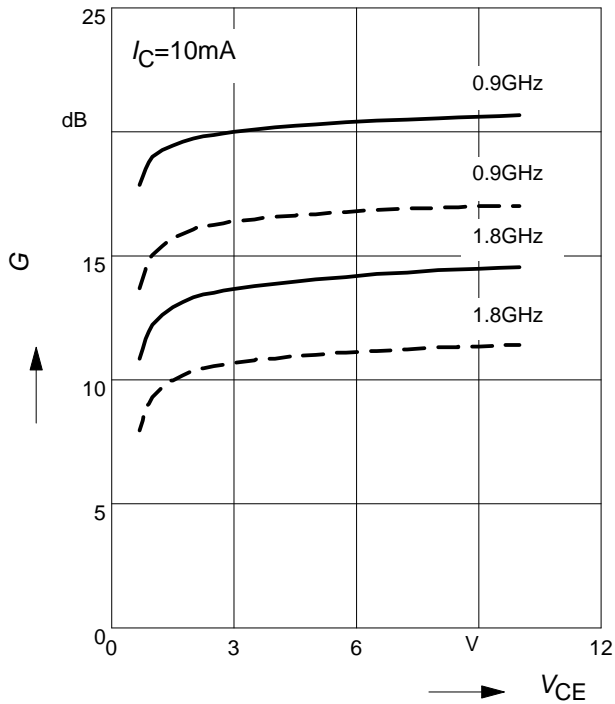

Power Gain G_{ma} , $G_{ms} = f(f)$

V_{CE} = Parameter

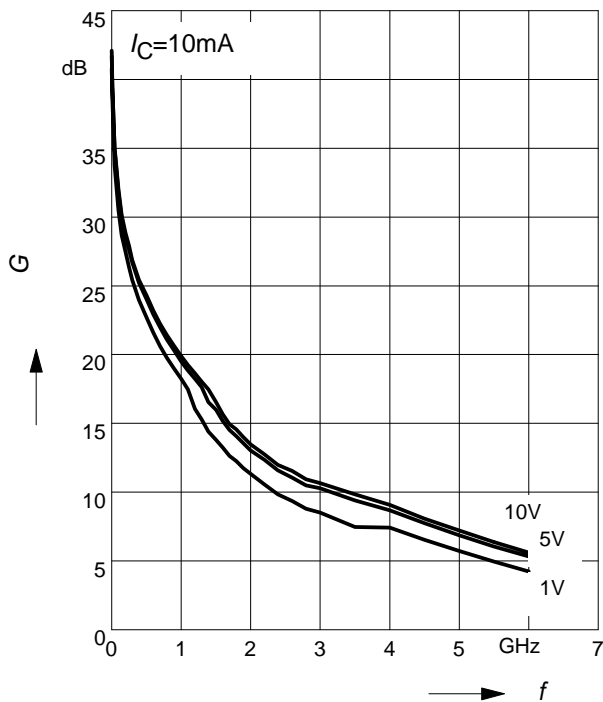

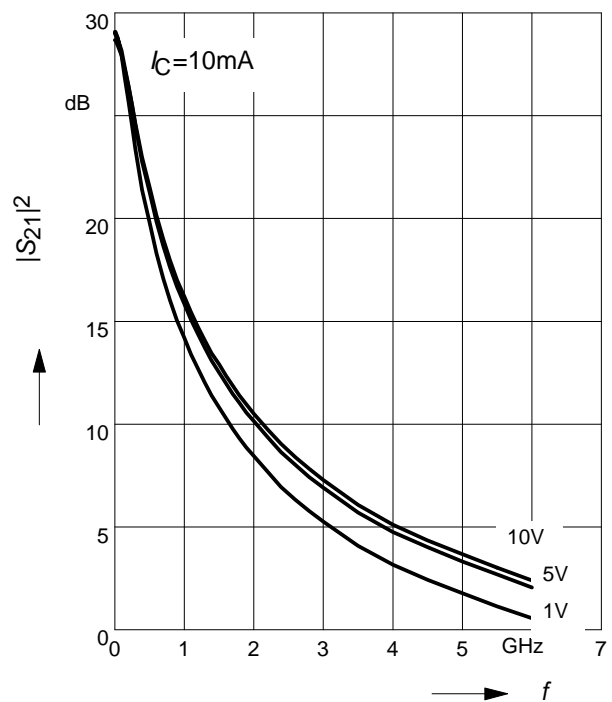

Power Gain $|S_{21}|^2 = f(f)$

V_{CE} = Parameter



Looking for pricing, stock, or lifecycle information?

Click below to explore more details on WIN SOURCE:

-  [View BFR949T on WIN SOURCE](#)
-  [Infineon Technologies Information](#)

Optimize Your Supply Chain with WIN SOURCE Solutions

-  Global Sourcing Solution
-  Obsolete Management
-  Cost Control Management
-  Shortage Management
-  Alternative Solution
-  Excess Inventory Management