



**THE DATASHEET OF  
TPS40007EVM-001**





---

# ***TPS40007-Based Converter Delivers 10-A Output***

*User's Guide*

## EVM IMPORTANT NOTICE

Texas Instruments (TI) provides the enclosed product(s) under the following conditions:

This evaluation kit being sold by TI is intended for use for **ENGINEERING DEVELOPMENT OR EVALUATION PURPOSES ONLY** and is not considered by TI to be fit for commercial use. As such, the goods being provided may not be complete in terms of required design-, marketing-, and/or manufacturing-related protective considerations, including product safety measures typically found in the end product incorporating the goods. As a prototype, this product does not fall within the scope of the European Union directive on electromagnetic compatibility and therefore may not meet the technical requirements of the directive.

Should this evaluation kit not meet the specifications indicated in the EVM User's Guide, the kit may be returned within 30 days from the date of delivery for a full refund. THE FOREGOING WARRANTY IS THE EXCLUSIVE WARRANTY MADE BY SELLER TO BUYER AND IS IN LIEU OF ALL OTHER WARRANTIES, EXPRESSED, IMPLIED, OR STATUTORY, INCLUDING ANY WARRANTY OF MERCHANTABILITY OR FITNESS FOR ANY PARTICULAR PURPOSE.

The user assumes all responsibility and liability for proper and safe handling of the goods. Further, the user indemnifies TI from all claims arising from the handling or use of the goods. Please be aware that the products received may not be regulatory compliant or agency certified (FCC, UL, CE, etc.). Due to the open construction of the product, it is the user's responsibility to take any and all appropriate precautions with regard to electrostatic discharge.

EXCEPT TO THE EXTENT OF THE INDEMNITY SET FORTH ABOVE, NEITHER PARTY SHALL BE LIABLE TO THE OTHER FOR ANY INDIRECT, SPECIAL, INCIDENTAL, OR CONSEQUENTIAL DAMAGES.

TI currently deals with a variety of customers for products, and therefore our arrangement with the user **is not exclusive**.

TI assumes **no liability for applications assistance, customer product design, software performance, or infringement of patents or services described herein**.

Please read the EVM User's Guide and, specifically, the EVM Warnings and Restrictions notice in the EVM User's Guide prior to handling the product. This notice contains important safety information about temperatures and voltages. For further safety concerns, please contact the TI application engineer.

Persons handling the product must have electronics training and observe good laboratory practice standards.

No license is granted under any patent right or other intellectual property right of TI covering or relating to any machine, process, or combination in which such TI products or services might be or are used.

Mailing Address:

Texas Instruments  
Post Office Box 655303  
Dallas, Texas 75265

### DYNAMIC WARNINGS AND RESTRICTIONS

It is important to operate this EVM within the input voltage range of  $0 V_{DC}$  to  $5.5 V_{DC}$ .

Exceeding the specified input range may cause unexpected operation and/or irreversible damage to the EVM. If there are questions concerning the input range, please contact a TI field representative prior to connecting the input power.

Applying loads outside of the specified output range may result in unintended operation and/or possible permanent damage to the EVM. Please consult the EVM User's Guide prior to connecting any load to the EVM output. If there is uncertainty as to the load specification, please contact a TI field representative.

During normal operation, some circuit components may have case temperatures greater than  $50^{\circ}\text{C}$ . The EVM is designed to operate properly with certain components above  $50^{\circ}\text{C}$  as long as the input and output ranges are maintained. These components include but are not limited to linear regulators, switching transistors, pass transistors, and current sense resistors. These types of devices can be identified using the EVM schematic located in the EVM User's Guide. When placing measurement probes near these devices during operation, please be aware that these devices may be very warm to the touch.

Mailing Address:

Texas Instruments  
Post Office Box 655303  
Dallas, Texas 75265

Copyright © 2004, Texas Instruments Incorporated

# TPS40007-Based Converter Delivers 10-A Output

Mark Dennis

DC to DC Controller Products

## Contents

<b>1</b>	<b>Introduction</b>	<b>4</b>
<b>2</b>	<b>Features</b>	<b>4</b>
<b>3</b>	<b>Schematic</b>	<b>5</b>
<b>3</b>	<b>Design Procedure</b>	<b>6</b>
<b>4</b>	<b>PowerPAD™ Packaging</b>	<b>10</b>
<b>5</b>	<b>Test Results/Performance Data</b>	<b>11</b>
<b>6</b>	<b>PCB Layout</b>	<b>14</b>
<b>7</b>	<b>List of Material</b>	<b>15</b>

## 1 Introduction

The TPS40007 is a voltage-mode, synchronous buck PWM controller that uses TI's proprietary Predictive Gate Drive™ technology to wring maximum efficiency from step-down converters. This controller provides a bootstrap circuit to allow the use of an N-channel MOSFET as the topside buck switch to reduce conduction losses and increase silicon device utilization. Predictive Gate Drive™ technology controls the delay from main switch turn-off to synchronous rectifier turn-on and also the delay from rectifier turn-off to main switch turn-on. This allows minimization of the losses in the MOSFET body diodes, both conduction and reverse recovery. This design note provides details on a buck converter that converts an input of 3 V to 5 V down to a 2.5-V output level using the TPS40007 controller.

A schematic for the board is shown in Figure 1. The list of material is provided in section 7 of this User's Guide.

## 2 Features

The specification for this board is as follows:

- $V_{IN} = 3.3 \text{ V to } 5 \text{ V}$
- $V_{OUT} = 2.5 \text{ V } \pm 3\%$
- $I_{OUT} = 0 \text{ A to } 10 \text{ A}$
- Efficiency = > 95% with  $V_{IN} = 3.3 \text{ V}$ ,  $I_{LOAD} = 4 \text{ A}$
- Output voltage ripple < 2%  $V_{OUT}$
- Power semiconductor devices: Each MOSFET is a single SO-8 package

### 3 Schematic

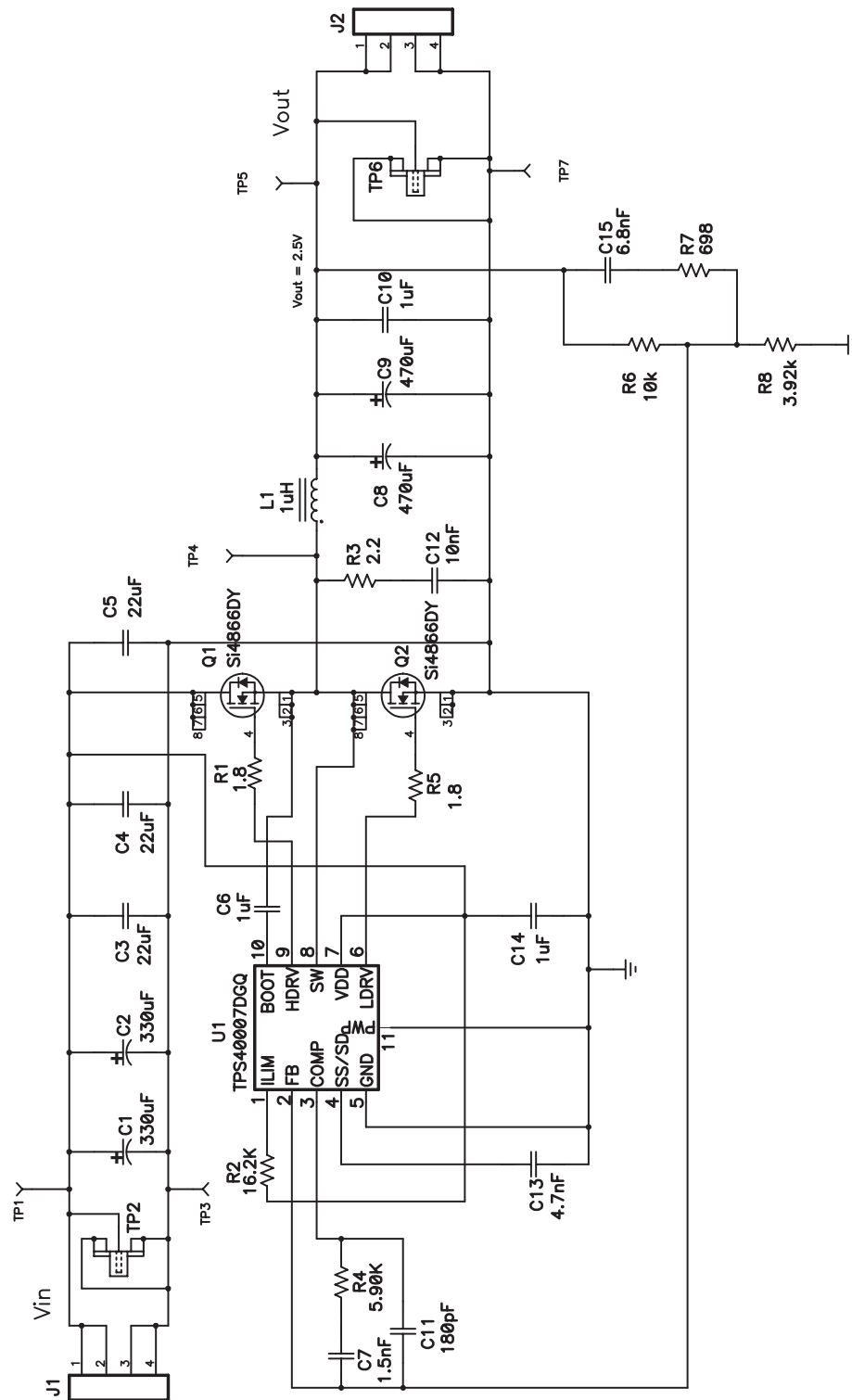

Figure 1. Application Diagram for the TPS4007EVM-001

## 4 Design Procedure

### 4.1 Controller Selection

The TPS40007 synchronous buck controller is selected for this high-current application because the 300-kHz switching frequency enables higher efficiency. The TPS40009 is available for applications needing 600-kHz operation for reducing component size. However, at higher frequency the efficiency is generally reduced, leading to more on-board power dissipation.

### 4.2 Inductance Value

The output inductor value is selected to set the ripple current to a value most suited to overall circuit functionality. An inductor selection that is too small leads to larger ripple current that increases RMS current losses in the inductor and MOSFETs, and also leads to more ripple voltage on the output. The inductor value is calculated by equation (1),

$$L_{\text{MIN}} = \frac{V_{\text{OUT}}}{f \times I_{\text{RIPPLE}}} \left( 1 - \frac{V_{\text{OUT}}}{V_{\text{IN(max)}}} \right) = \frac{2.5 \text{ V}}{300 \text{ kHz} \times 4 \text{ A}} \times \left( 1 - \frac{2.5 \text{ V}}{5 \text{ V}} \right) = 1.0 \mu\text{H} \quad (1)$$

in which  $I_{\text{RIPPLE}}$  is chosen to be 40% of  $I_{\text{OUT}}$ , or 4 A at max  $V_{\text{IN}}$ . This high value of ripple current is selected to keep the inductor small to minimize the  $R_{\text{DS(on)}}$  losses due to the high output current. A synchronous rectifier controller that maintains continuous inductor current down to no load eliminates concerns arising from crossing the DCM boundary. A standard value of 1  $\mu\text{H}$  with a resistance of 3.5 m $\Omega$  is selected. At full load the power loss is only 0.35 W, which is only 1.4% of the 25-W output power.

### 4.3 Input Capacitor Selection

Bulk input capacitor selection is based on allowable input voltage ripple and required RMS current carrying capability. In typical buck converter applications, the converter is fed from an upstream power converter with its own output capacitance. In this standalone supply, onboard capacitance is added to handle input voltage ripple and RMS current considerations. For this power level, input voltage ripple of 150 mV is reasonable, and a conservative minimum value of capacitance is calculated as

$$C = \frac{I \times \Delta t}{\Delta V} = \frac{10 \text{ A} \times 2.5 \mu\text{s}}{0.15 \text{ V}} = 167 \mu\text{F} \quad (2)$$

In addition to this minimum capacitance requirement, the RMS current stresses must be considered. In this converter, the large duty cycle causes the input RMS current to be nearly as large as the output current. This simplified formula calculates the RMS current for a trapezoidal current waveform, shown in equation (3).

$$I_{\text{RMS}} = I \times \sqrt{D} = I \times \sqrt{\frac{V_{\text{OUT}}}{V_{\text{IN(min)}}}} = 10 \text{ A} \times \sqrt{\frac{2.5 \text{ V}}{3.0 \text{ V}}} = 9.1 \text{ A} \quad (3)$$

Additional terms for the ripple component of the current add only a small amount to the total RMS current, and can be neglected. To meet this initial requirement with small size and cost, a combination of capacitors is considered. To carry the high frequency ripple current, three 22- $\mu\text{F}$ , X5R ceramic capacitors are placed close to the power circuitry. Although these capacitors have an extremely small resistance, the datasheet indicates that the part undergoes a 30°C temperature rise with 2 A<sub>RMS</sub> current at 500 kHz, so more current capability is needed. Two 330- $\mu\text{F}$  POSCAPs with an RMS current capability of 4.4 A each is selected. In typical embedded converters, these POSCAPs is not required if the upstream converter feeding this buck has sufficient current handling capability.

#### 4.4 Output Capacitor Selection

Selection of the output capacitor is based on many application variables, including function, cost, size, and availability. First, the minimum allowable output capacitance should be determined by the amount of inductor ripple current and one-half the allowable output ripple, as given in equation (4).

$$C_{\text{OUT(min)}} = \frac{I_{\text{RIPPLE}}}{8 \times f \times V_{\text{RIPPLE}}} = \frac{4 \text{ A}}{8 \times 300 \text{ kHz} \times 25 \text{ mV}} = 67 \mu\text{F} \quad (4)$$

This only affects the capacitive component of the ripple voltage. In addition, the voltage component due to the capacitor ESR must be considered, shown in equation (5).

$$\text{ESR}_{\text{Cout}} \leq \frac{V_{\text{RIPPLE}}}{I_{\text{RIPPLE}}} = \frac{25 \text{ mV}}{4 \text{ A}} = 6.25 \text{ m}\Omega \quad (5)$$

To minimize capacitor size while maintaining good transient response, two 470- $\mu\text{F}$  POSCAPs (with an ESR of 10 m $\Omega$  each) are fitted in parallel with a 1- $\mu\text{F}$  ceramic capacitor.

#### 4.5 MOSFET Selection

One constraint of this design is the use of one SO-8 MOSFET in the upper switch device and one SO-8 in the lower synchronous rectifier location in the buck converter power stage. The upper device loss is usually dominated by switching loss, so a device with lower gate charge and switching times was selected. Since this application has a relatively high output voltage, the upper device runs at a high duty cycle and needs to have a low  $R_{\text{DS(on)}}$  to keep conduction losses low, and an 8-m $\Omega$  device with a maximum gate charge of 30 nC is selected. The same device is fitted in the bottom switch location to achieve high efficiency.

#### 4.6 Short Circuit Protection

The TPS40003 implements short circuit protection by comparing the voltage across the topside MOSFET while it is on to a voltage dropped from VDD by  $R_{\text{LIM}}$  due to an internal current source of 15  $\mu\text{A}$  inside pin 1. Due to tolerances in the current source and variations in the power MOSFET on-voltage versus temperature, the short circuit level can protect against gross overcurrent conditions only, and should be set much higher than rated load. In this particular case,  $R_{\text{LIM}}$  is selected as shown in equation (6).

$$R_{\text{LIM}} = R2 = \frac{3 \times I_{\text{OUT}} \times R_{\text{DS(on)}}}{15 \mu\text{A}} = \frac{3 \times 10 \text{ A} \times 0.008 \Omega}{15 \mu\text{A}} = 15 \text{ k}\Omega \quad (6)$$

For this design, a standard value of 16.2 k $\Omega$  is selected for R2. The factor of 3 in the equation accounts for the variations in component tolerances (both initial and over temperature) and output current ripple. The component tolerances include MOSFET  $R_{\text{DS(on)}}$ ,  $I_{\text{LIM}}$  sink current, and the  $V_{\text{OS}}$  offset voltage of SW vs  $I_{\text{LIM}}$ .

## 4.7 Compensation Design

The TPS40007 uses voltage mode control in conjunction with a high frequency error amplifier. The power circuit L-C double pole corner frequency  $f_C$  is located in equation (7).

$$f_{\text{req}_{LC}} = \frac{1}{2 \times \pi \times \sqrt{L_{\text{OUT}} \times C_{\text{OUT}}}} = 5.1 \text{ kHz} \quad (7)$$

The output capacitor ESR zero is calculated by equation (8),

$$F_{Z(\text{esr})} = \frac{1}{2 \times \pi \times R_{\text{ESR}} \times C_{\text{OUT}}} = 33.8 \text{ kHz} \quad (8)$$

where the two POSCAPs ESR of 5 mΩ is used in the calculation because the 1 μF is effectively out of the picture at these relatively low frequencies.

The feedback compensation network is implemented to provide two zeroes and three poles. The first pole is placed near the origin to improve dc regulation.

The first zero is placed below  $f_C$  at 2.2 kHz in equation (9).

$$f_{z1} = \frac{1}{2 \times \pi \times (R_6 + R_7) \times C_{15}} \quad (9)$$

The second zero is placed at 18 kHz shown in equation (10).

$$f_{z2} = \frac{1}{2 \times \pi \times R_4 \times C_7} \quad (10)$$

The first pole is placed near the ESR zero frequency in equation (11),

$$f_{p1} = \frac{1}{2 \times \pi \times R_7 \times C_{15}} \quad (11)$$

and the second pole is placed at one-half the switching frequency at 150 kHz to allow a high-speed transient response, shown in equation (12).

$$f_{p2} = \frac{1}{2 \times \pi \times R_4 \times \left( \frac{C_7 \times C_{11}}{C_7 + C_{11}} \right)} \quad (12)$$

Figure 2 presents the measured loop gain and phase characteristics. At the loop crossover frequency of 20 kHz the phase margin is approximately 50 degrees.

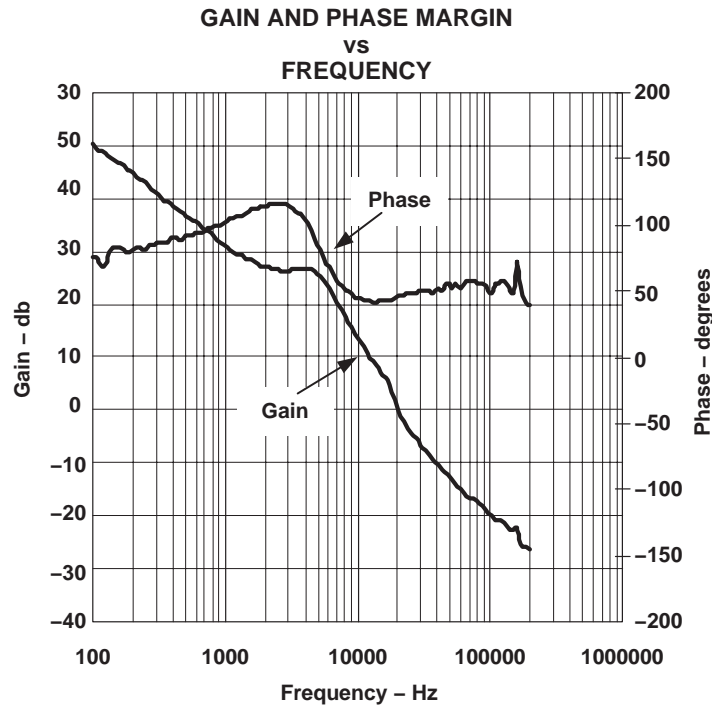

Figure 2.

#### 4.8 Snubber Component Selection

The switch node where Q1 and L1 come together is very noisy. An R-C network fitted between this node and ground can help reduce ringing and voltage overshoot on Q2. This ringing noise should be minimized to prevent it from confusing the control circuitry which is monitoring this node for current limit, Predictive Gate Drive™, and DCM control functions.

As a starting point, the snubber capacitor, C12, is generally chosen to be 5 to 8 times larger than the parasitic capacitance at the node, which is primarily C<sub>OS</sub> of Q2. Since C<sub>OS</sub> is around 1600 pF for Q2 at 5 V, C12 is chosen to be 10 nF. R3 is empirically determined to be 2.2 Ω, which minimizes the ringing and overshoot at the switch node. With the relatively low input voltage of 5 V, the power loss,  $\frac{1}{2} CV^2f$ , is relatively small at 37 mW.

## 5 PowerPAD™ Packaging

The TPS4000X family is available in the DGQ version of TI's PowerPAD™ thermally enhanced package. In the PowerPAD™, a thermally conductive epoxy is utilized to attach the integrated circuit die to the leadframe die pad, which is exposed on the bottom of the completed package. The leadframe die pad can be soldered to the PCB using standard solder flow techniques when maximum heat dissipation is required. However, depending on power dissipation requirements, the PowerPAD™ may not need to be soldered to the PCB.

The thermally conductive epoxy bonding the circuit die to the leadframe die pad causes a high resistance from the leadframe die pad to the device ground pin 5. When the PowerPad™ package is soldered to the PCB, the leadframe die pad can be connected to ground (pin 5), but this is not required. The leadframe die pad should not be connected to other potentials in the circuit.

The PowerPAD™ package helps to keep the junction temperature rise relatively low even with the power dissipation inherent in the onboard MOSFET drivers. This power loss is proportional to switching frequency, drive voltage, and the gate charge needed to enhance the N-channel MOSFETs. Effective heat removal allows the use of ultra small packaging while maintaining high component reliability.

To effectively remove heat from the PowerPAD™ package, a thermal land should be provided directly underneath the package. This thermal land usually has vias that help to spread heat to internal copper layers and/or the opposite side of the PCB. The vias should not have thermal reliefs that are often used on ground planes, because this reduces the copper area to transfer heat. Additionally, the vias should be small enough so that the holes are effectively plugged when plated. This prevents the solder from wicking away from the connection between the PCB surface and the bottom of the part. A typical footprint pattern is shown in Figure 2, but does not include the additional copper plane which includes the vias above and below the device.

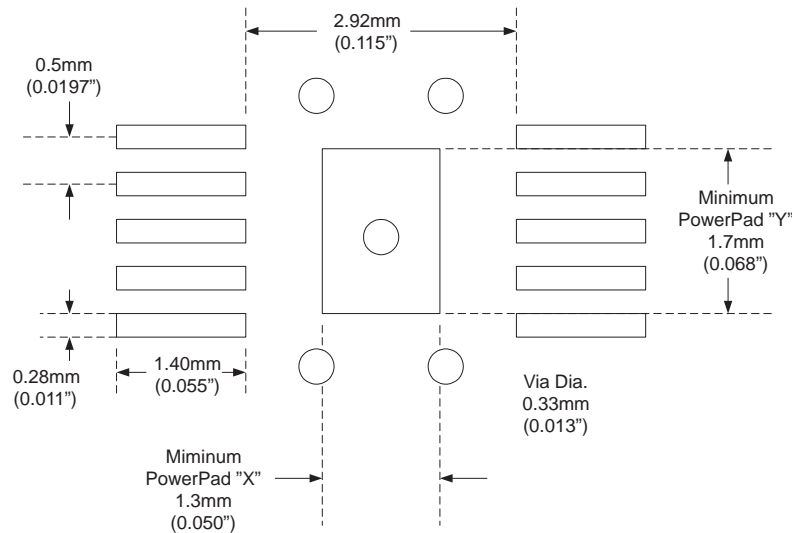

**Figure 3. PowerPAD™ PCB Layout Guidelines**

The Texas Instrument document, PowerPAD™ Thermally Enhanced Package Application Report (Texas Instrument Literature Number SLMA002) should be consulted for more information on the PowerPAD™ package. This report offers in-depth information on the package, assembly and rework techniques, and illustrative examples of the thermal performance of the PowerPAD™ package.

## 6 Test Results/Performance Data

### 6.1 Test Setup

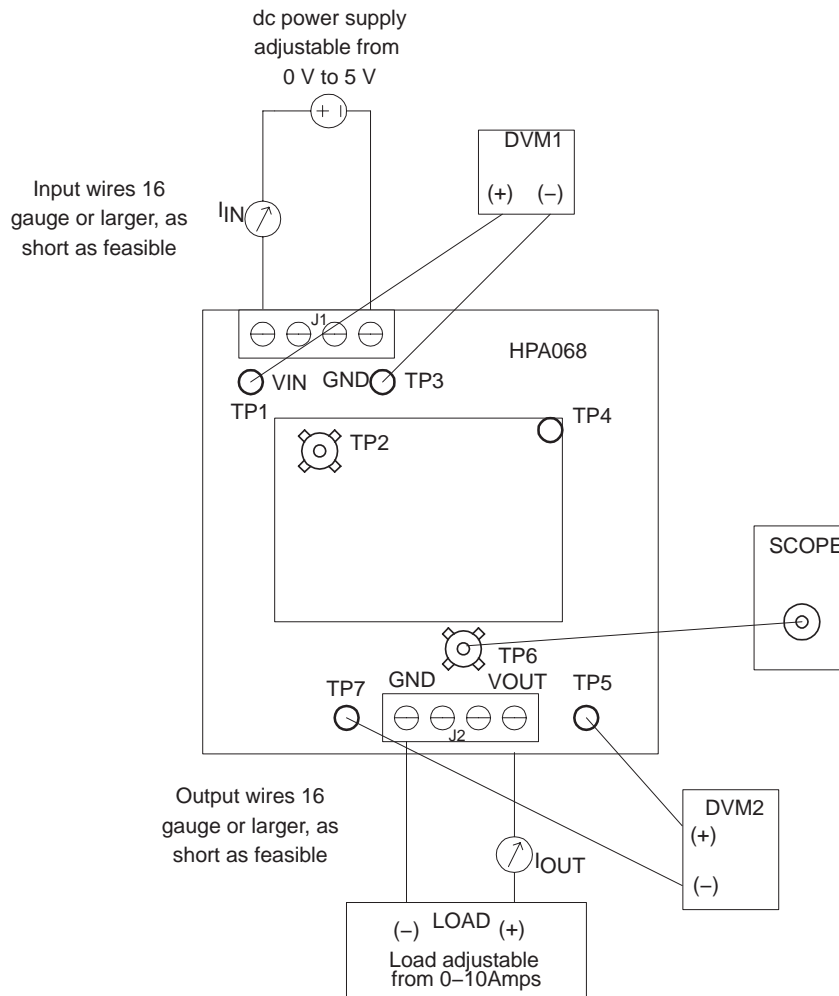

Figure 4. Test Setup

Typical efficiency curves are shown in Figure 5 for 3.3-V input. It should be stressed that measuring high efficiencies requires the utmost care in instrumentation. The power losses are so low that small errors can lead to large variations in measured efficiency. The input and output voltages are measured on the PCB as shown in the test diagram to avoid the losses associated with the input and output connectors.

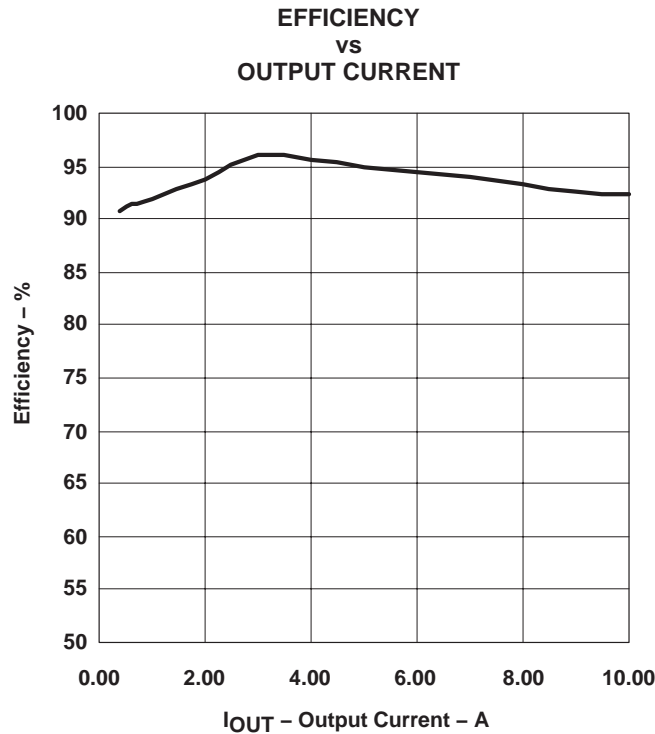

Figure 5.

Figure 6 shows the switch node at  $V_{IN} = 5\text{ V}$  and  $I_{OUT} = 10\text{ A}$ . As the picture indicates, there is almost negligible body diode conduction using the Predictive Gate Drive™ technique.

TYPICAL SWITCH NODE WAVEFORM

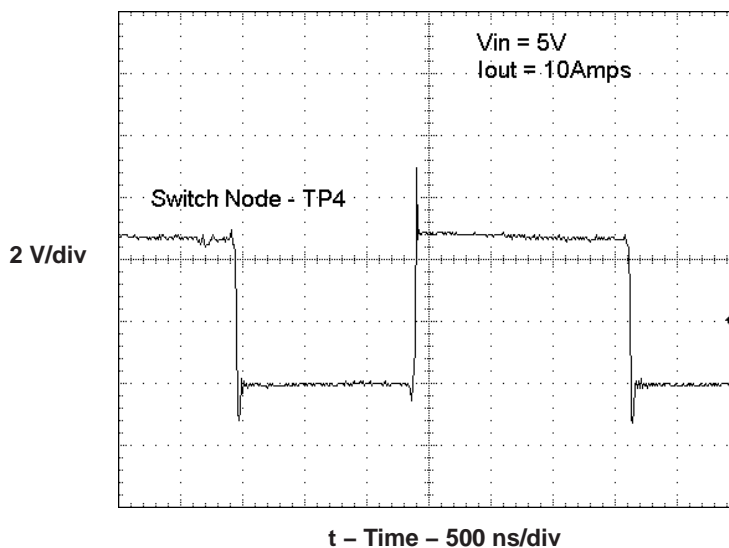
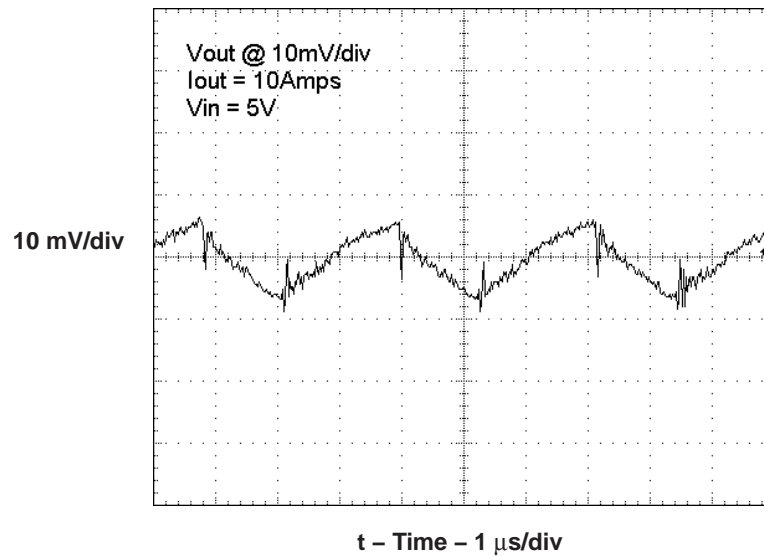

Figure 6.

Figure 7 shows the output voltage ripple at high  $V_{IN}$  and full load, which is the worst case condition for output voltage ripple.

**OUTPUT VOLTAGE RIPPLE**



**Figure 7.**

Figure 8 shows the transient response with a 50% load step from 2.5 A to 7.5 A.

**TRANSIENT RESPONSE**

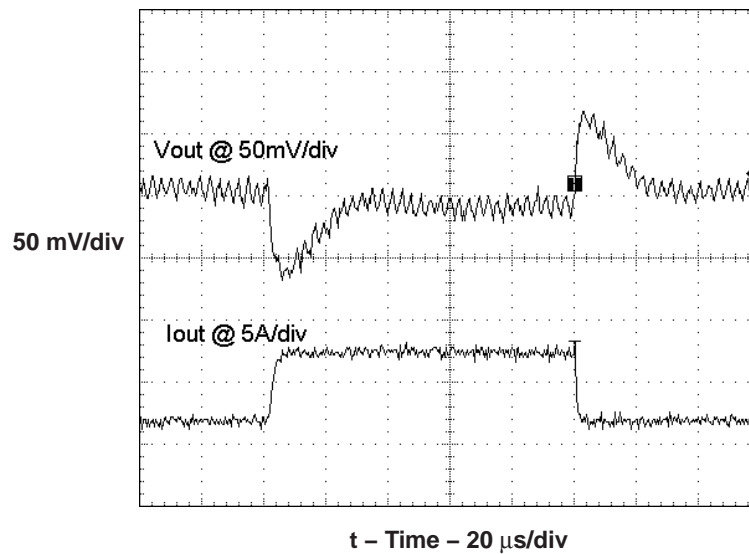

**Figure 8.**

## 7 PCB Layout

The PCB top assembly and copper layers are shown in Figures 9 through 11.

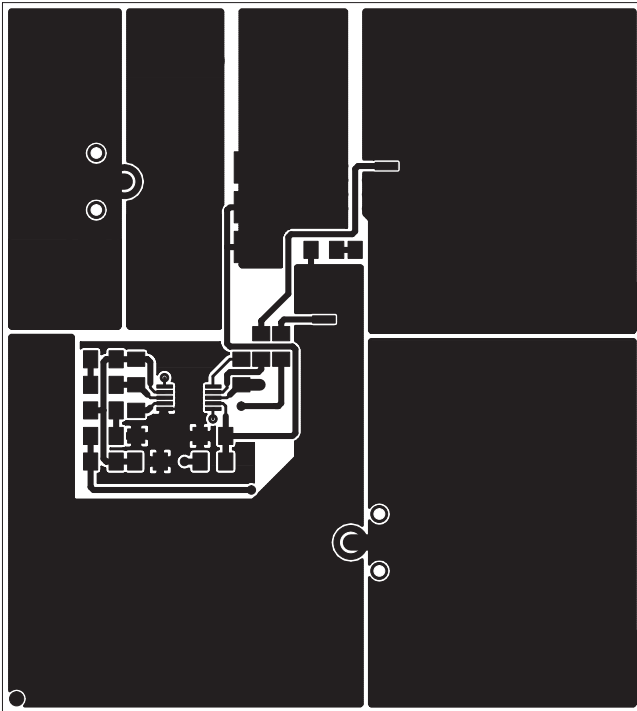

Figure 9

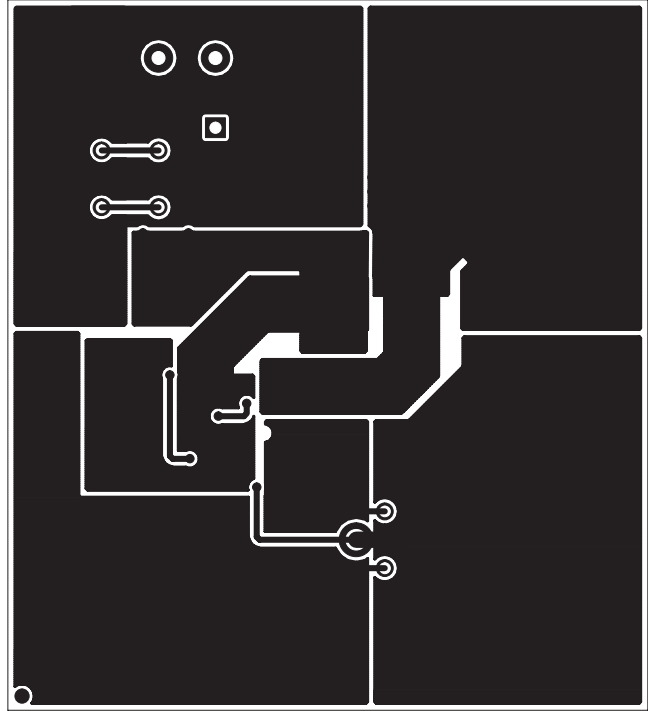

Figure 10

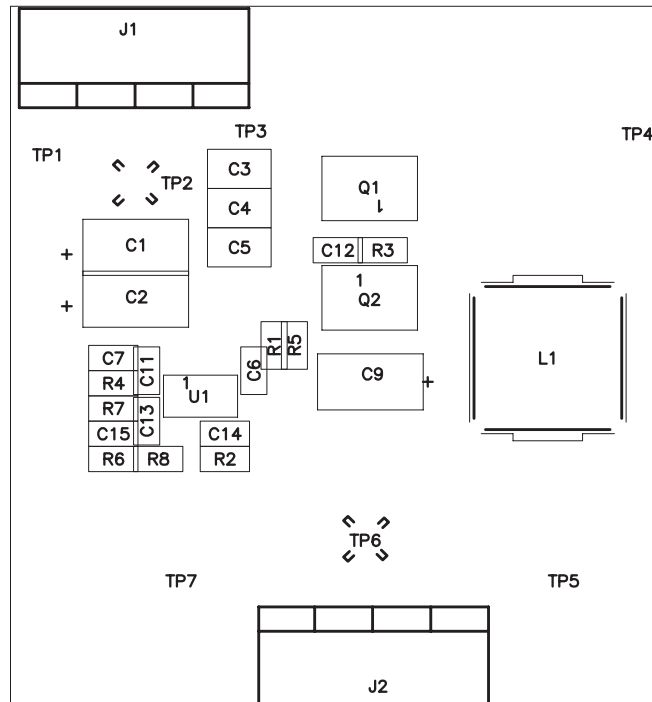

Figure 11

## 8 List of Material

Table 1 lists the components used in this design. With minor component tweaks this design could be modified to meet a wide range of applications.

	Reference	Qty	Description	Manufacturer	Part Number
Capacitor	C1, C2	2	POSCAP, 330 $\mu$ F, 6.3 V, 10 milliohm, 20%, 7343 (D)	Sanyo	6TPD330M
	C11	1	Ceramic, 180 pF, 50 V, NPO, 10%, 805	Vishay	VJ0805A181KXAAT
	C12	1	Ceramic, 0.01 $\mu$ F, 50 V, X7R, 10%, 805	Vishay	VJ0805Y103KXAAT
	C13	1	Ceramic, 0.0047 $\mu$ F, 50 V, X7R, 10%, 805	Vishay	VJ0805Y472KXAAT
	C15	1	Ceramic, 6.8 nF, 50 V, X7R, 10%, 805	Vishay	VJ0805Y682KXAAT
	C3, C4, C5	3	Ceramic, 22 $\mu$ F, 6.3 V, X5R, 20%, 1210	Panasonic	ECJ-4YB0J226M
	C6, C10, C14	3	Ceramic, 1 $\mu$ F, 10 V, X5R, 10%, 805	Panasonic	ECJ-2YB1A105K
	C7	1	Ceramic, 1.5 nF, 50 V, X7R, 10%, 805	Vishay	VJ0805Y152KXAAT
	C8, C9	2	POSCAP, 470 $\mu$ F, 4 V, 10 m $\Omega$ , 20%, 7343 (D)	Sanyo	4TPD470M
Terminal Block	J1, J2	2	4-pin, 15 A, 5.1 mm, 291126	OST	ED2227
Inductor	L1	1	Inductor, SMT, 1 $\mu$ H, 15 A, 3.5 m $\Omega$ , 0.51 x 0.51	Vishay	IHLP-5050CE-01
MOSFET	Q1, Q2	2	MOSFET, N-channel, 12 V, 17 A, 5.5 m $\Omega$ , SO8	Siliconix	Si4866DY
Resistor	R1, R5	1	Chip, 1.8 $\Omega$ , 1/10 W, 5%, 805	Std	Std
	R2	1	Chip, 16.2 k $\Omega$ , 1/10 W, 1%, 805	Std	Std
	R3	1	Chip, 2.2 $\Omega$ , 1/10 W, 5%, 805	Std	Std
	R4	1	Chip, 5.90 k $\Omega$ , 1/10 W, 1%, 805	Std	Std
	R6	1	Chip, 10 k $\Omega$ , 1/10 W, 1%, 805	Std	Std
	R7	1	Chip, 698 $\Omega$ , 1/10 W, 1%, 805	Std	Std
	R8	1	Chip, 3.92 $\Omega$ , 1/10 W, 1%, 805	Std	Std
JACK	TP1, TP4, TP5,	3	Red, 1 mm, 0.038", 6400"	Farnell	240-345
Adapter	TP2, TP6	2	3.5-mm probe clip (or 131-5031-00), 72900	Tektronix	131-4244-00
JACK	TP3, TP7	1	Black, 1mm, 0.038", 6400"	Farnell	240-333
Device	U1	1	Low Input Voltage Mode, Synchronous Buck Controller DGQ10	TI	TPS40007DGQ

## IMPORTANT NOTICE

Texas Instruments Incorporated and its subsidiaries (TI) reserve the right to make corrections, modifications, enhancements, improvements, and other changes to its products and services at any time and to discontinue any product or service without notice. Customers should obtain the latest relevant information before placing orders and should verify that such information is current and complete. All products are sold subject to TI's terms and conditions of sale supplied at the time of order acknowledgment.

TI warrants performance of its hardware products to the specifications applicable at the time of sale in accordance with TI's standard warranty. Testing and other quality control techniques are used to the extent TI deems necessary to support this warranty. Except where mandated by government requirements, testing of all parameters of each product is not necessarily performed.

TI assumes no liability for applications assistance or customer product design. Customers are responsible for their products and applications using TI components. To minimize the risks associated with customer products and applications, customers should provide adequate design and operating safeguards.

TI does not warrant or represent that any license, either express or implied, is granted under any TI patent right, copyright, mask work right, or other TI intellectual property right relating to any combination, machine, or process in which TI products or services are used. Information published by TI regarding third-party products or services does not constitute a license from TI to use such products or services or a warranty or endorsement thereof. Use of such information may require a license from a third party under the patents or other intellectual property of the third party, or a license from TI under the patents or other intellectual property of TI.

Reproduction of information in TI data books or data sheets is permissible only if reproduction is without alteration and is accompanied by all associated warranties, conditions, limitations, and notices. Reproduction of this information with alteration is an unfair and deceptive business practice. TI is not responsible or liable for such altered documentation.

Resale of TI products or services with statements different from or beyond the parameters stated by TI for that product or service voids all express and any implied warranties for the associated TI product or service and is an unfair and deceptive business practice. TI is not responsible or liable for any such statements.

Following are URLs where you can obtain information on other Texas Instruments products and application solutions:

<b>Products</b>		<b>Applications</b>	
Amplifiers	<a href="http://amplifier.ti.com">amplifier.ti.com</a>	Audio	<a href="http://www.ti.com/audio">www.ti.com/audio</a>
Data Converters	<a href="http://dataconverter.ti.com">dataconverter.ti.com</a>	Automotive	<a href="http://www.ti.com/automotive">www.ti.com/automotive</a>
DSP	<a href="http://dsp.ti.com">dsp.ti.com</a>	Broadband	<a href="http://www.ti.com/broadband">www.ti.com/broadband</a>
Interface	<a href="http://interface.ti.com">interface.ti.com</a>	Digital Control	<a href="http://www.ti.com/digitalcontrol">www.ti.com/digitalcontrol</a>
Logic	<a href="http://logic.ti.com">logic.ti.com</a>	Military	<a href="http://www.ti.com/military">www.ti.com/military</a>
Power Mgmt	<a href="http://power.ti.com">power.ti.com</a>	Optical Networking	<a href="http://www.ti.com/opticalnetwork">www.ti.com/opticalnetwork</a>
Microcontrollers	<a href="http://microcontroller.ti.com">microcontroller.ti.com</a>	Security	<a href="http://www.ti.com/security">www.ti.com/security</a>
		Telephony	<a href="http://www.ti.com/telephony">www.ti.com/telephony</a>
		Video & Imaging	<a href="http://www.ti.com/video">www.ti.com/video</a>
		Wireless	<a href="http://www.ti.com/wireless">www.ti.com/wireless</a>

Mailing Address: Texas Instruments  
Post Office Box 655303 Dallas, Texas 75265

## Looking for pricing, stock, or lifecycle information?

Click below to explore more details on WIN SOURCE:

- ⊖ [View TPS40007EVM-001 on WIN SOURCE](#)
- ⊖ [Texas Instruments](#) Information

## Optimize Your Supply Chain with WIN SOURCE Solutions

- ✓ Global Sourcing Solution
- ✓ Obsolete Management
- ✓ Cost Control Management
- ✓ Shortage Management
- ✓ Alternative Solution
- ✓ Excess Inventory Management