



**THE DATASHEET OF
TPS77825PWPR**



- Open Drain Power-On Reset With 200 ms Delay (TPS777xx)
- Open Drain Power Good (TPS778xx)
- 750-mA Low-Dropout Voltage Regulator
- Available in 1.5-V, 1.8-V, 2.5-V, 3.3-V Fixed Output and Adjustable Versions
- Dropout Voltage to 260 mV (Typ) at 750 mA (TPS77x33)
- Ultralow 85 μA Typical Quiescent Current
- Fast Transient Response
- 2% Tolerance Over Specified Conditions for Fixed-Output Versions
- 8-Pin SOIC and 20-Pin TSSOP PowerPAD™ (PWP) Package
- Thermal Shutdown Protection

description

TPS777xx and TPS778xx are designed to have a fast transient response and be stable with a 10 μF low ESR capacitor. This combination provides high performance at a reasonable cost.

PWP PACKAGE
(TOP VIEW)

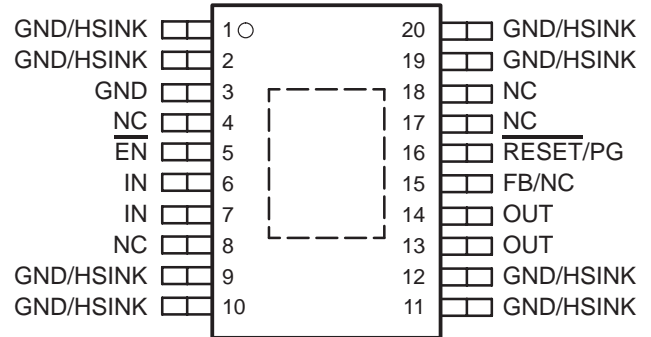

NC – No internal connection

D PACKAGE
(TOP VIEW)

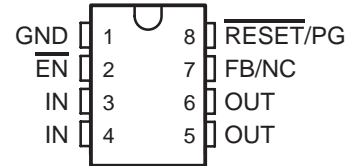

TPS77x33
DROPOUT VOLTAGE
vs
FREE-AIR TEMPERATURE

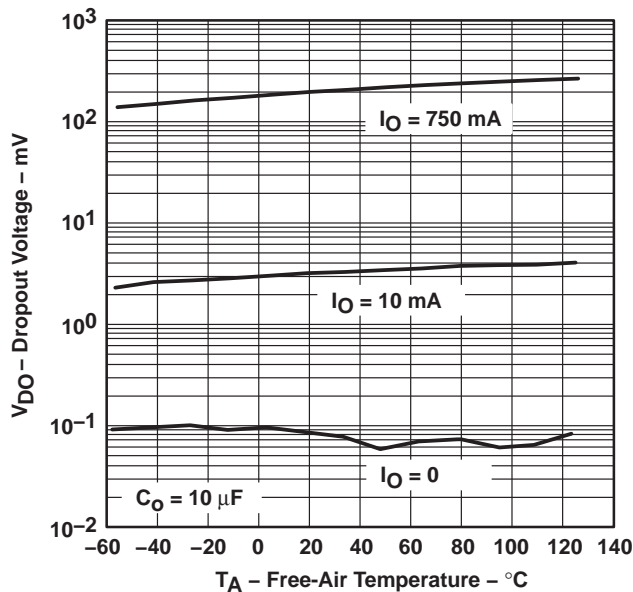

TPS77x33
LOAD TRANSIENT RESPONSE

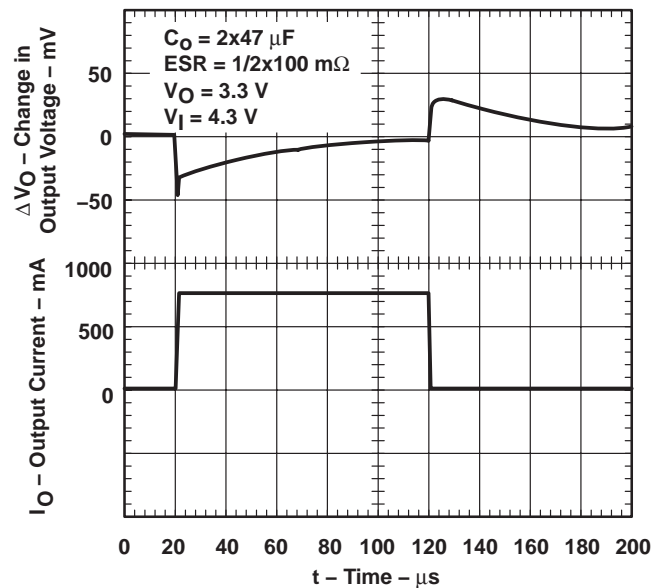

Please be aware that an important notice concerning availability, standard warranty, and use in critical applications of Texas Instruments semiconductor products and disclaimers thereto appears at the end of this data sheet.

All trademarks are the property of their respective owners.

description (continued)

Because the PMOS device behaves as a low-value resistor, the dropout voltage is very low (typically 260 mV at an output current of 750 mA for the TPS77x33) and is directly proportional to the output current. Additionally, since the PMOS pass element is a voltage-driven device, the quiescent current is very low and independent of output loading (typically 85 μA over the full range of output current, 0 mA to 750 mA). These two key specifications yield a significant improvement in operating life for battery-powered systems. This LDO family also features a sleep mode; applying a TTL high signal to $\overline{\text{EN}}$ (enable) shuts down the regulator, reducing the quiescent current to 1 μA at $T_J = 25^\circ\text{C}$.

The $\overline{\text{RESET}}$ output of the TPS777xx initiates a reset in microcomputer and microprocessor systems in the event of an undervoltage condition. An internal comparator in the TPS777xx monitors the output voltage of the regulator to detect an undervoltage condition on the regulated output voltage.

Power good (PG) of the TPS778xx is an active high output, which can be used to implement a power-on reset or a low-battery indicator.

The TPS777xx and TPS778xx are offered in 1.5-V, 1.8-V, 2.5-V, and 3.3-V fixed-voltage versions and in an adjustable version (programmable over the range of 1.5 V to 5.5 V for the TPS77701 option and 1.2 V to 5.5 V for the TPS77801 option). Output voltage tolerance is specified as a maximum of 2% over line, load, and temperature ranges. The TPS777xx and TPS778xx families are available in 8-pin SOIC and 20-pin PWP packages.

AVAILABLE OPTIONS

T_J	OUTPUT VOLTAGE (V)	PACKAGED DEVICES			
	TYP	TSSOP (PWP)		SOIC (D)	
-40°C to 125°C	3.3	TPS77733PWP	TPS77833PWP	TPS77733D	TPS77833D
	2.5	TPS77725PWP	TPS77825PWP	TPS77725D	TPS77825D
	1.8	TPS77718PWP	TPS77818PWP	TPS77718D	TPS77818D
	1.5	TPS77715PWP	TPS77815PWP	TPS77715D	TPS77815D
	Adjustable 1.5 V to 5.5 V	TPS77701PWP	—	TPS77701D	—
	Adjustable 1.2 V to 5.5 V	—	TPS77801PWP	—	TPS77801D

The TPS77x01 is programmable using an external resistor divider (see application information). The D and PWP packages are available taped and reeled. Add an R suffix to the device type (e.g., TPS77701DR).

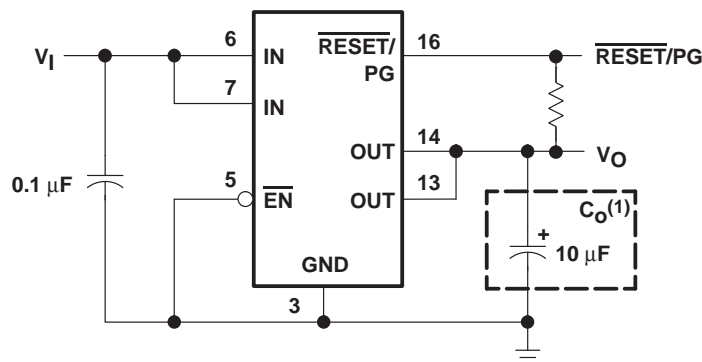

(1) See application information section for capacitor selection details.

Figure 1. Typical Application Configuration for Fixed Output Options

functional block diagram—adjustable version

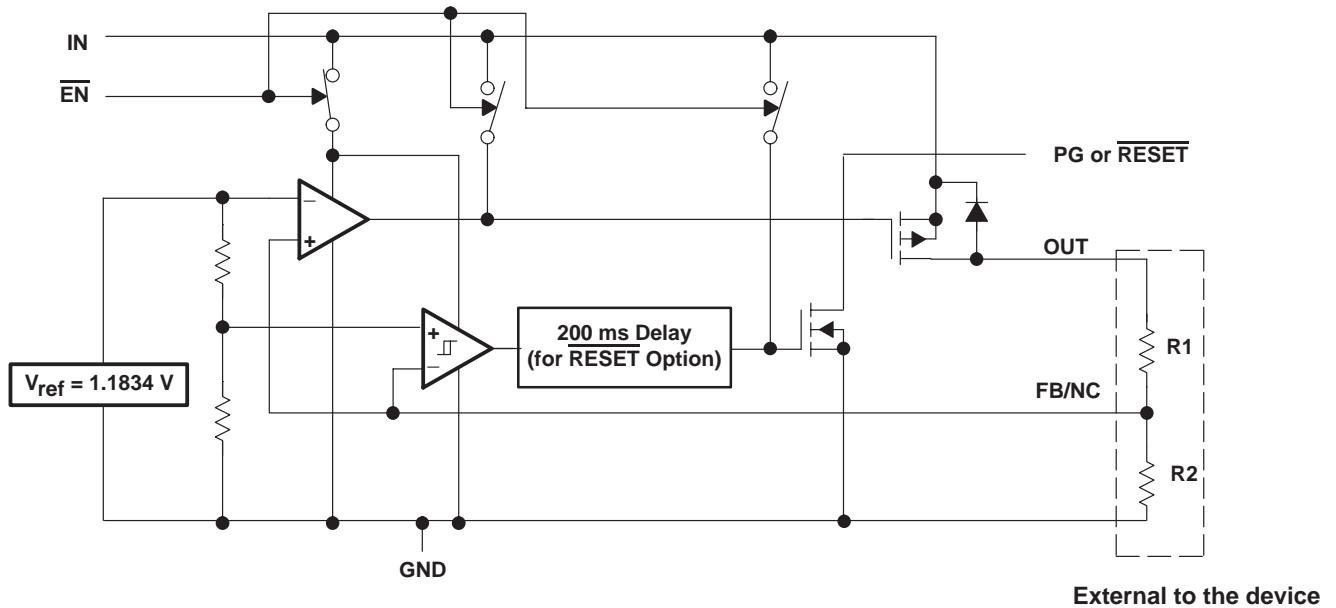

functional block diagram—fixed-voltage version

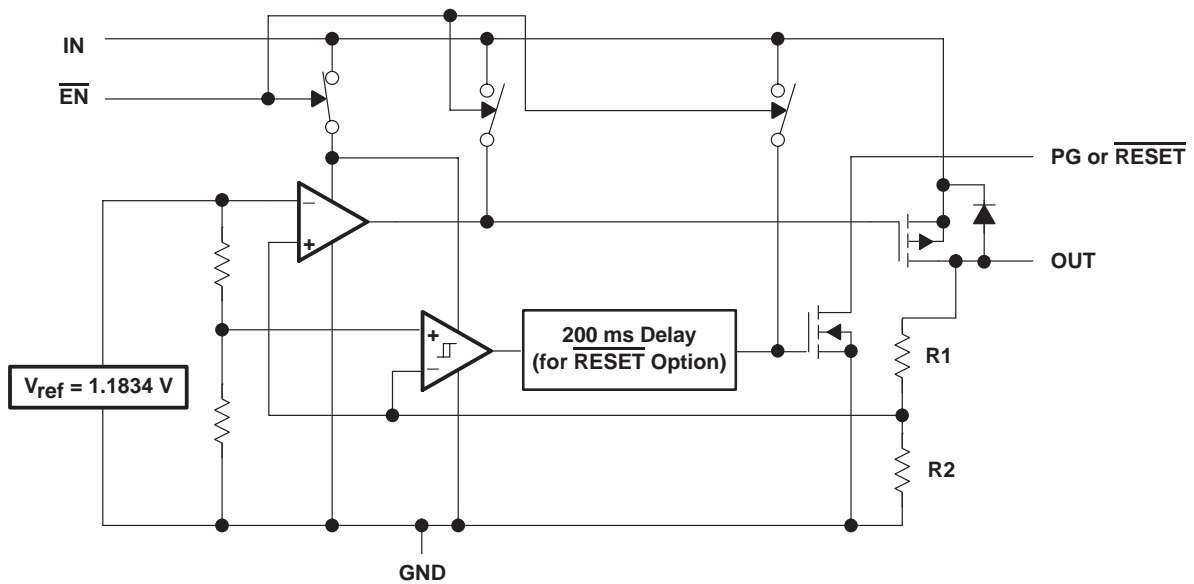

TPS77701, TPS77715, TPS77718, TPS77725, TPS77733 with RESET OUTPUT
TPS77801, TPS77815, TPS77818, TPS77825, TPS77833 with PG OUTPUT
FAST-TRANSIENT-RESPONSE 750-mA LOW-DROPOUT LINEAR REGULATORS



SLVS230G – SEPTEMBER 1999 – REVISED JANUARY 2004

Terminal Functions

SOIC Package (TPS777xx)

TERMINAL NAME	NO.	I/O	DESCRIPTION
EN	2	I	Enable input
FB/NC	7	I	Feedback input voltage for adjustable device (no connect for fixed options)
GND	1		Regulator ground
IN	3, 4	I	Input voltage
OUT	5, 6	O	Regulated output voltage
RESET	8	O	RESET output

TSSOP Package (TPS777xx)

TERMINAL NAME	NO.	I/O	DESCRIPTION
EN	5	I	Enable input
FB/NC	15	I	Feedback input voltage for adjustable device (no connect for fixed options)
GND	3		Regulator ground
GND/HSINK	1, 2, 9, 10, 11, 12, 19, 20		Ground/heatsink
IN	6, 7	I	Input
NC	4, 8, 17, 18		No connect
OUT	13, 14	O	Regulated output voltage
RESET	16	O	RESET output

SOIC Package (TPS778xx)

TERMINAL NAME	NO.	I/O	DESCRIPTION
EN	2	I	Enable input
FB/NC	7	I	Feedback input voltage for adjustable device (no connect for fixed options)
GND	1		Regulator ground
IN	3, 4	I	Input voltage
OUT	5, 6	O	Regulated output voltage
PG	8	O	PG output

TSSOP Package (TPS778xx)

TERMINAL NAME	NO.	I/O	DESCRIPTION
EN	5	I	Enable input
FB/NC	15	I	Feedback input voltage for adjustable device (no connect for fixed options)
GND	3		Regulator ground
GND/HSINK	1, 2, 9, 10, 11, 12, 19, 20		Ground/heatsink
IN	6, 7	I	Input
NC	4, 8, 17, 18		No connect
OUT	13, 14	O	Regulated output voltage
PG	16	O	PG output

TPS777xx $\overline{\text{RESET}}$ timing diagram

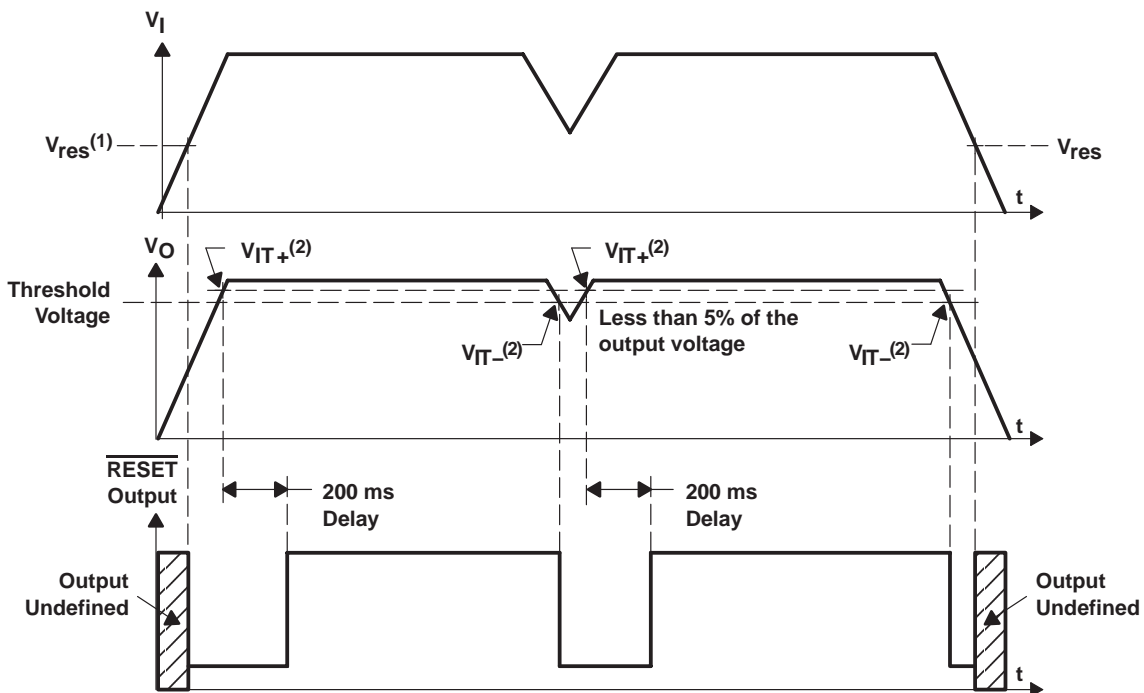

(1) V_{res} is the minimum input voltage for a valid $\overline{\text{RESET}}$. The symbol V_{res} is not currently listed within EIA or JEDEC standards for semiconductor symbology.

(2) V_{IT-} – Trip voltage is typically 5% lower than the output voltage ($95\%V_O$). V_{IT-} to V_{IT+} is the hysteresis voltage.

TPS77701, TPS77715, TPS77718, TPS77725, TPS77733 with RESET OUTPUT
TPS77801, TPS77815, TPS77818, TPS77825, TPS77833 with PG OUTPUT
FAST-TRANSIENT-RESPONSE 750-mA LOW-DROPOUT LINEAR REGULATORS



SLVS230G – SEPTEMBER 1999 – REVISED JANUARY 2004

absolute maximum ratings over operating free-air temperature range (unless otherwise noted)(1)

Input voltage range ⁽²⁾ , V_I	-0.3 V to 13.5 V
Voltage range at EN	-0.3 V to 16.5 V
Maximum RESET voltage (TPS777xx)	16.5 V
Maximum PG voltage (TPS778xx)	16.5 V
Peak output current	Internally limited
Output voltage, V_O (OUT, FB)	7 V
Continuous total power dissipation	See dissipation rating tables
Operating junction temperature range, T_J	-40°C to 125°C
Storage temperature range, T_{stg}	-65°C to 150°C
ESD rating, HBM	2 kV

- (1) Stresses beyond those listed under *absolute maximum ratings* may cause permanent damage to the device. These are stress ratings only, and functional operation of the device at these or any other conditions beyond those indicated under *recommended operating conditions* is not implied. Exposure to absolute-maximum-rated conditions for extended periods may affect device reliability.
- (2) All voltage values are with respect to network terminal ground.

DISSIPATION RATING TABLE 1 – FREE-AIR TEMPERATURES

PACKAGE	AIR FLOW (CFM)	$T_A < 25^\circ\text{C}$ POWER RATING	DERATING FACTOR ABOVE $T_A = 25^\circ\text{C}$	$T_A = 70^\circ\text{C}$ POWER RATING	$T_A = 85^\circ\text{C}$ POWER RATING
D	0	568 mW	5.68 mW/°C	312 mW	227 mW
	250	904 mW	9.04 mW/°C	497 mW	361 mW

DISSIPATION RATING TABLE 2 – FREE-AIR TEMPERATURES

PACKAGE	AIR FLOW (CFM)	$T_A < 25^\circ\text{C}$ POWER RATING	DERATING FACTOR ABOVE $T_A = 25^\circ\text{C}$	$T_A = 70^\circ\text{C}$ POWER RATING	$T_A = 85^\circ\text{C}$ POWER RATING
PWP§	0	2.9 W	23.5 mW/°C	1.9 W	1.5 W
	300	4.3 W	34.6 mW/°C	2.8 W	2.2 W
PWP¶	0	3 W	23.8 mW/°C	1.9 W	1.5 W
	300	7.2 W	57.9 mW/°C	4.6 W	3.8 W

- (1) This parameter is measured with the recommended copper heat sink pattern on a 1-layer PCB, 5 in × 5 in PCB, 1 oz. copper, 2 in × 2 in coverage (4 in²).
- (2) This parameter is measured with the recommended copper heat sink pattern on a 8-layer PCB, 1.5 in × 2 in PCB, 1 oz. copper with layers 1, 2, 4, 5, 7, and 8 at 5% coverage (0.9 in²) and layers 3 and 6 at 100% coverage (6 in²). For more information, refer to TI technical brief SLMA002.

recommended operating conditions

		MIN	MAX	UNIT
Input voltage, V_I ⁽¹⁾		2.7	10	V
Output voltage range, V_O	TPS77701	1.5	5.5	V
	TPS77801	1.2	5.5	
Operating junction temperature, T_J		-40	125	°C

(1) Minimum $V_{IN} = V_{OUT} + V_{DO}$ or 2.7V, whichever is greater.

electrical characteristics over recommended operating temperature range ($T_J = -40^\circ\text{C}$ to 125°C), $V_I = V_{O(\text{typ})} + 1\text{ V}$, $I_O = 1\text{ mA}$, $\overline{\text{EN}} = 0\text{ V}$, $C_O = 10\ \mu\text{F}$ (unless otherwise noted)

PARAMETER		TEST CONDITIONS	MIN	TYP	MAX	UNIT
Output voltage (10 μA to 750 mA load)	TPS77701	$1.5\text{ V} \leq V_O \leq 5.5\text{ V}$, $T_J = 25^\circ\text{C}$	V_O			V
		$1.5\text{ V} \leq V_O \leq 5.5\text{ V}$,	0.98	V_O	1.02	
	TPS77801	$1.2\text{ V} \leq V_O \leq 5.5\text{ V}$, $T_J = 25^\circ\text{C}$	V_O			
		$1.2\text{ V} \leq V_O \leq 5.5\text{ V}$,	0.98	V_O	1.02	
	TPS77x15	$T_J = 25^\circ\text{C}$, $2.7\text{ V} < V_{IN} < 10\text{ V}$	1.5			
		$T_J = -40^\circ\text{C}$ to 125°C , $2.7\text{ V} < V_{IN} < 10\text{ V}$	1.470	1.530		
	TPS77x18	$T_J = 25^\circ\text{C}$, $2.8\text{ V} < V_{IN} < 10\text{ V}$	1.8			
		$T_J = -40^\circ\text{C}$ to 125°C , $2.8\text{ V} < V_{IN} < 10\text{ V}$	1.764	1.836		
	TPS77x25	$T_J = 25^\circ\text{C}$, $3.5\text{ V} < V_{IN} < 10\text{ V}$	2.5			
		$T_J = -40^\circ\text{C}$ to 125°C , $3.5\text{ V} < V_{IN} < 10\text{ V}$	2.450	2.550		
	TPS77x33	$T_J = 25^\circ\text{C}$, $4.3\text{ V} < V_{IN} < 10\text{ V}$	3.3			
		$T_J = -40^\circ\text{C}$ to 125°C , $4.3\text{ V} < V_{IN} < 10\text{ V}$	3.234	3.366		
Quiescent current (GND current)		$10\ \mu\text{A} < I_O < 750\text{ mA}$, $T_J = 25^\circ\text{C}$	85			μA
		$I_O = 750\text{ mA}$	125			
Output voltage line regulation ($\Delta V_O/V_O$)		$V_O + 1\text{ V} < V_I \leq 10\text{ V}$, $T_J = 25^\circ\text{C}$	0.01			%/V
Load regulation			3			mV
Output noise voltage (TPS77x18)		BW = 200 Hz to 100 kHz, $C_O = 10\ \mu\text{F}$, $T_J = 25^\circ\text{C}$, $I_C = 750\ \mu\text{A}$	54			μV_{rms}
Output current limit		$V_O = 0\text{ V}$	1.2	1.7	2	A
Thermal shutdown junction temperature			150			$^\circ\text{C}$
Standby current		$\overline{\text{EN}} = V_I$, $T_J = 25^\circ\text{C}$, $2.7\text{ V} < V_I < 10\text{ V}$	1			μA
		$\overline{\text{EN}} = V_I$, $2.7\text{ V} < V_I < 10\text{ V}$	10			μA
FB input current	TPS77x01	FB = 1.5 V	2			nA
High level enable input voltage			1.7			V
Low level enable input voltage			0.9			V
Power supply ripple rejection		$f = 1\text{ KHz}$, $C_O = 10\ \mu\text{F}$, $T_J = 25^\circ\text{C}$	60			dB
Reset (TPS77xx)	Minimum input voltage for valid $\overline{\text{RESET}}$	$I_O(\text{RESET}) = 300\ \mu\text{A}$	1.1			V
	Trip threshold voltage	V_O decreasing	92	98		% V_O
	Hysteresis voltage	Measured at V_O	0.5			% V_O
	Output low voltage	$V_I = 2.7\text{ V}$, $I_O(\text{RESET}) = 1\text{ mA}$	0.15	0.4		V
	Leakage current	$V(\text{RESET}) = 5\text{ V}$	1			μA
	RESET time-out delay		200			ms

TPS77701, TPS77715, TPS77718, TPS77725, TPS77733 with $\overline{\text{RESET}}$ OUTPUT
TPS77801, TPS77815, TPS77818, TPS77825, TPS77833 with PG OUTPUT
FAST-TRANSIENT-RESPONSE 750-mA LOW-DROPOUT LINEAR REGULATORS



SLVS230G – SEPTEMBER 1999 – REVISED JANUARY 2004

electrical characteristics over recommended operating temperature range ($T_J = -40^\circ\text{C}$ to 125°C), $V_I = V_{O(\text{typ})} + 1\text{ V}$, $I_O = 1\text{ mA}$, $\overline{\text{EN}} = 0\text{ V}$, $C_O = 10\text{ }\mu\text{F}$ (unless otherwise noted) (continued)

PARAMETER		TEST CONDITIONS	MIN	TYP	MAX	UNIT
PG (TPS778xx)	Minimum input voltage for valid PG	$I_{O(\text{PG})} = 300\text{ }\mu\text{A}$		1.1		V
	Trip threshold voltage	V_O decreasing	92		98	$\%V_O$
	Hysteresis voltage	Measured at V_O		0.5		$\%V_O$
	Output low voltage	$V_I = 2.7\text{ V}$, $I_{O(\text{PG})} = 1\text{ mA}$		0.15	0.4	V
	Leakage current	$V(\text{PG}) = 5\text{ V}$			1	μA
Input current ($\overline{\text{EN}}$)		$\overline{\text{EN}} = 0\text{ V}$	-1	0	1	μA
		$\overline{\text{EN}} = V_I$	-1		1	
Dropout voltage (1)	TPS77733	$I_O = 750\text{ mA}$, $T_J = 25^\circ\text{C}$		260		mV
		$I_O = 750\text{ mA}$,			427	
	TPS77833	$I_O = 750\text{ mA}$, $T_J = 25^\circ\text{C}$		260		
		$I_O = 750\text{ mA}$,			427	

(1) IN voltage equals $V_{O(\text{typ})} - 100\text{ mV}$; TPS77x01 output voltage set to 3.3 V nominal with external resistor divider. TPS77x15, TPS77x18, and TPS77x25 dropout voltage limited by input voltage range limitations (i.e., TPS77x33 input voltage needs to drop to 3.2 V for purpose of this test).

TYPICAL CHARACTERISTICS

Table of Graphs

		FIGURE	
V_O	Output voltage	vs Output current	2, 3, 4
		vs Free-air temperature	5, 6, 7
	Ground current	vs Free-air temperature	8
	Power supply ripple rejection	vs Frequency	9
	Output spectral noise density	vs Frequency	10
Z_O	Output impedance	vs Frequency	11
V_{DO}	Dropout voltage	vs Input voltage	12
		vs Free-air temperature	13
	Input voltage (min)	vs Output voltage	14
	Line transient response		15, 17
	Load transient response		16, 18
V_O	Output voltage	vs Time	19
	Equivalent series resistance (ESR)	vs Output current	21 – 24

TYPICAL CHARACTERISTICS

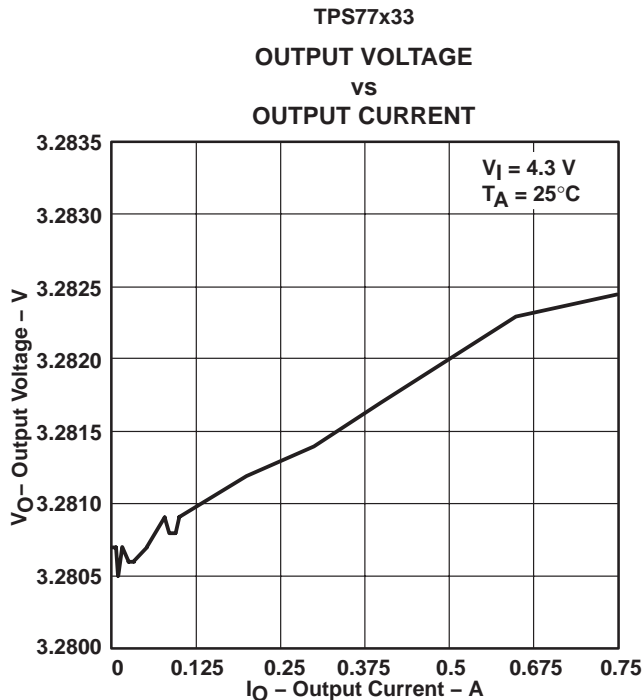

Figure 2

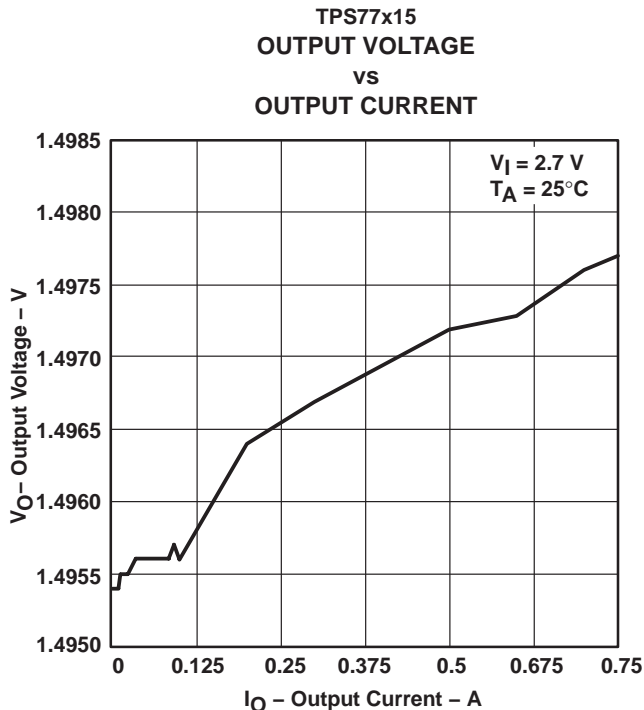

Figure 3

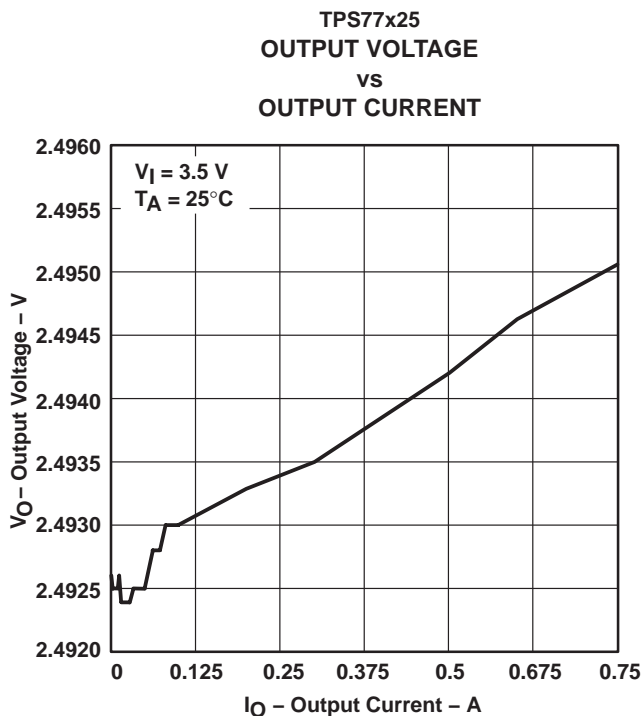

Figure 4

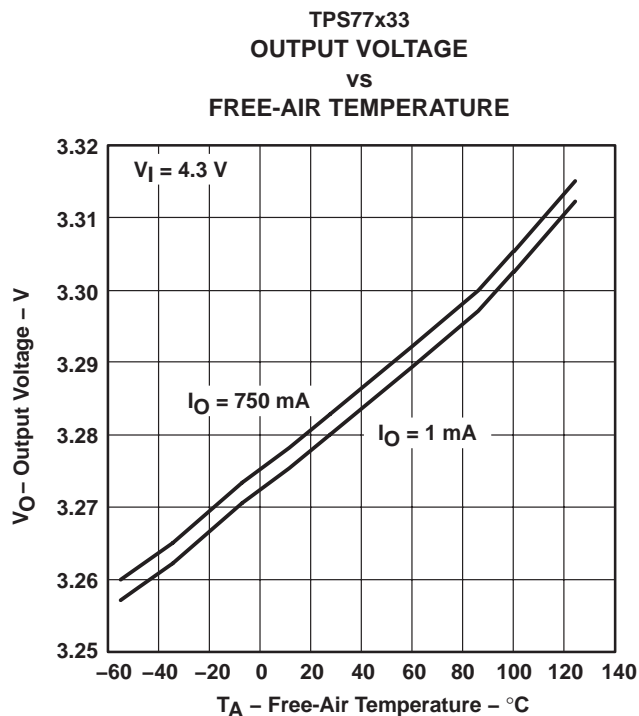

Figure 5

TYPICAL CHARACTERISTICS

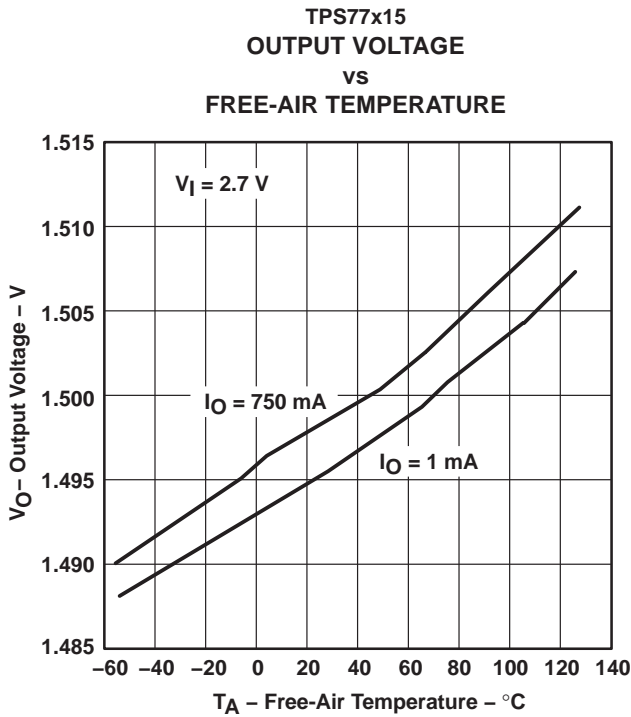

Figure 6

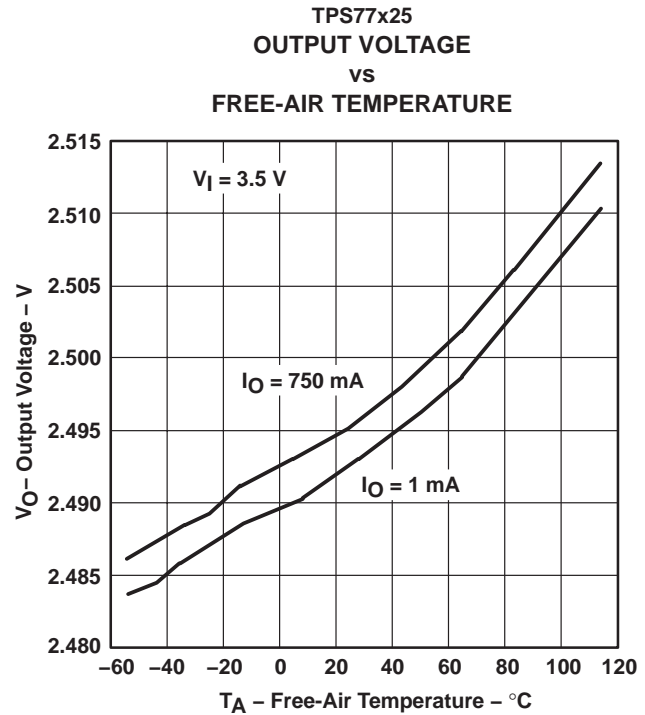

Figure 7

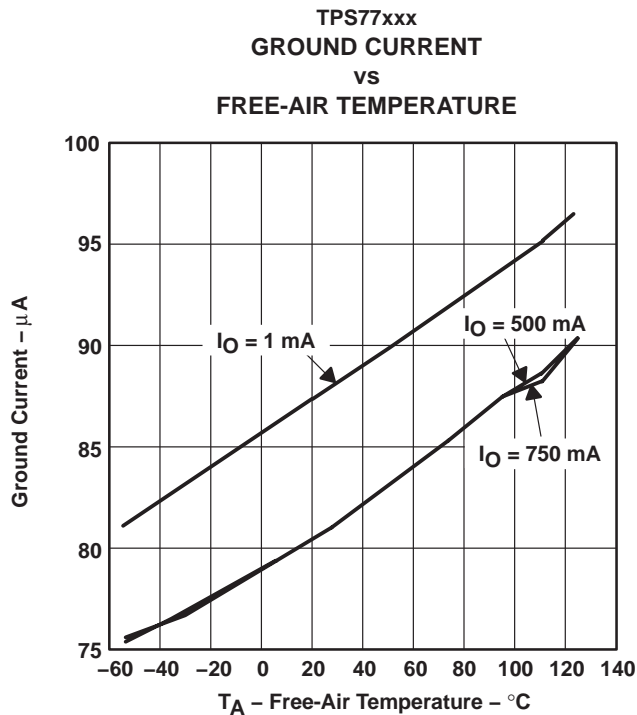

Figure 8

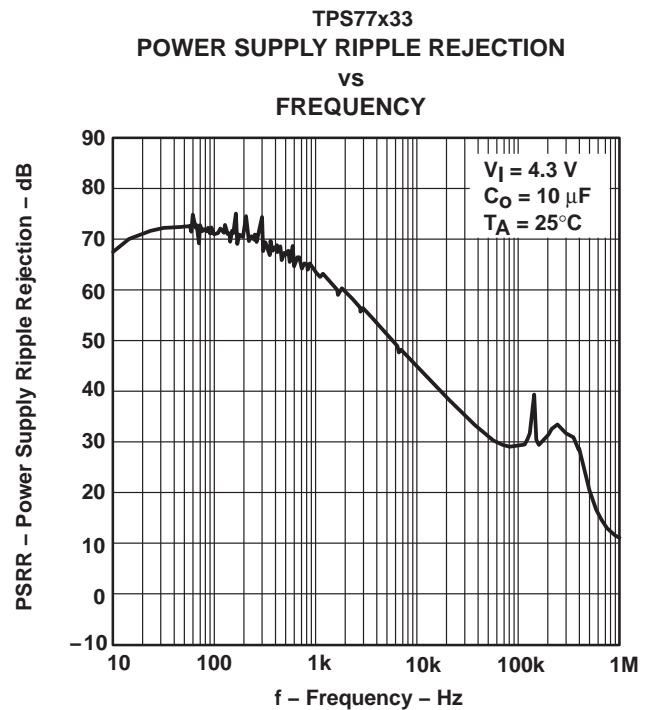

Figure 9

TYPICAL CHARACTERISTICS

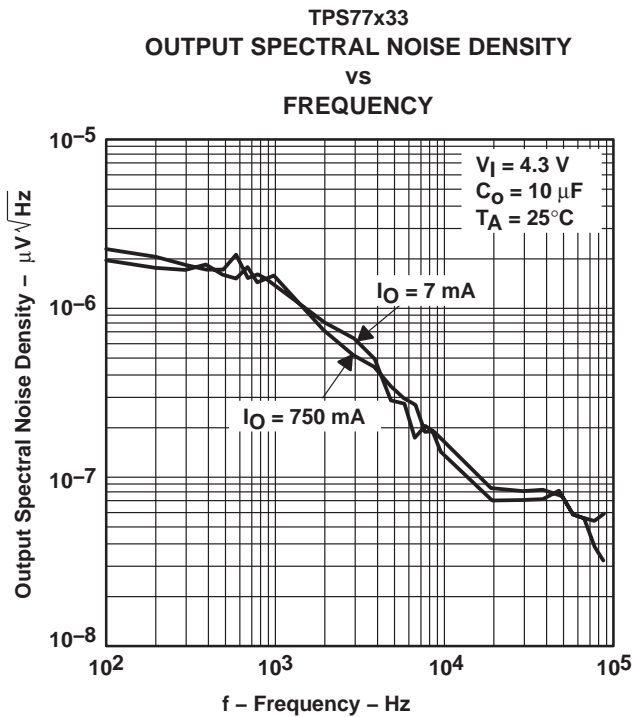

Figure 10

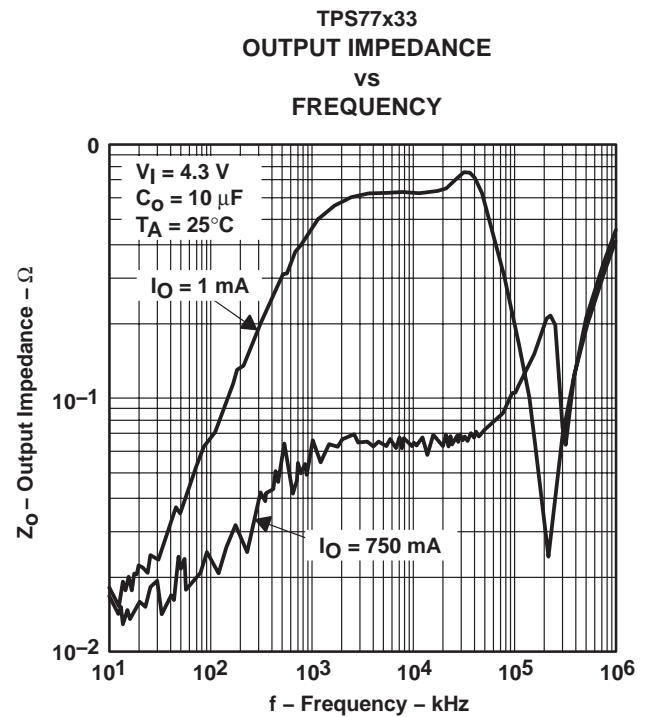

Figure 11

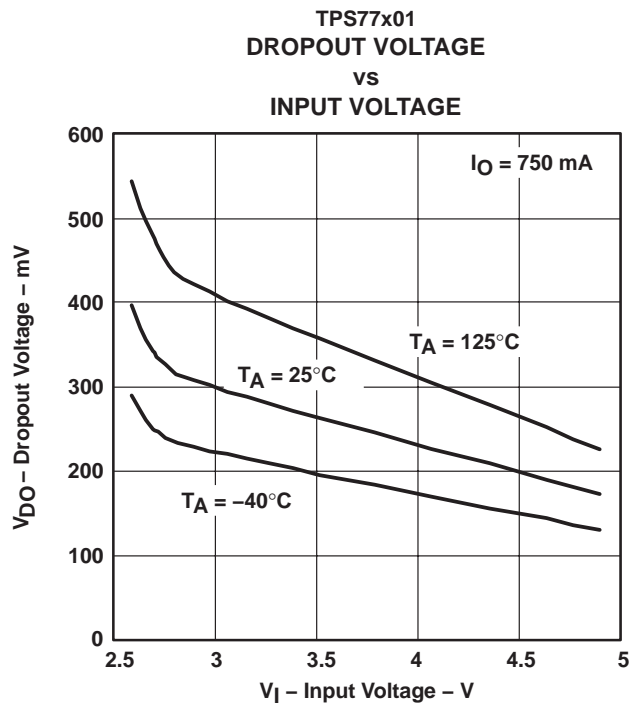

Figure 12

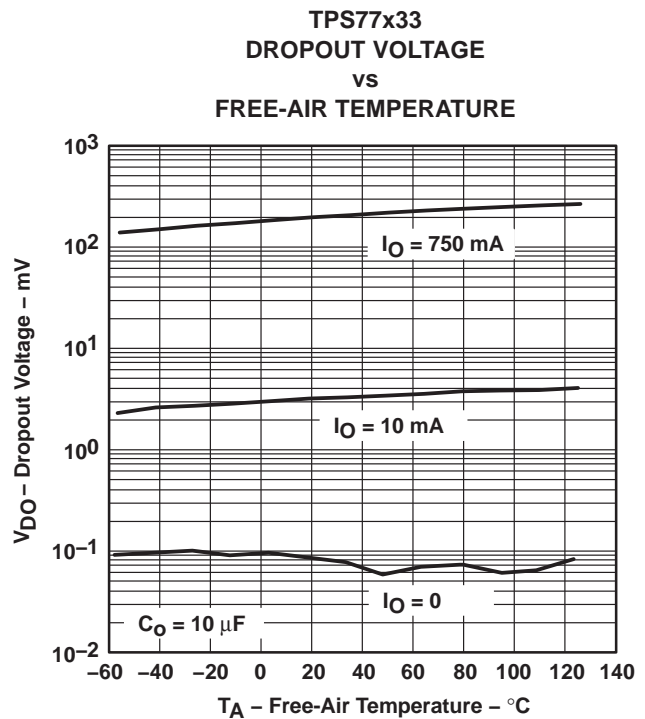
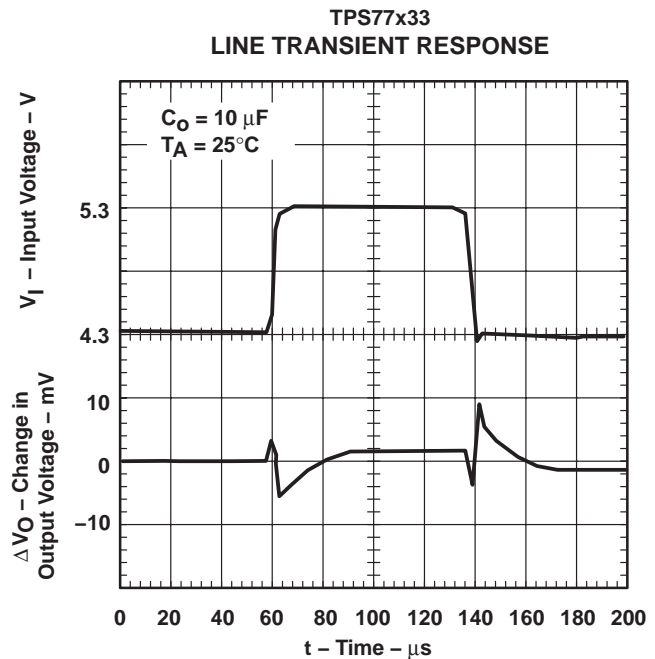
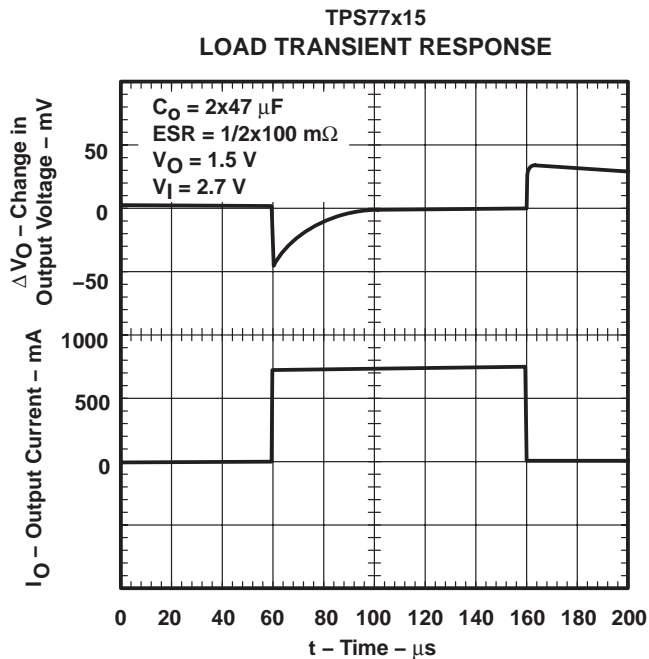
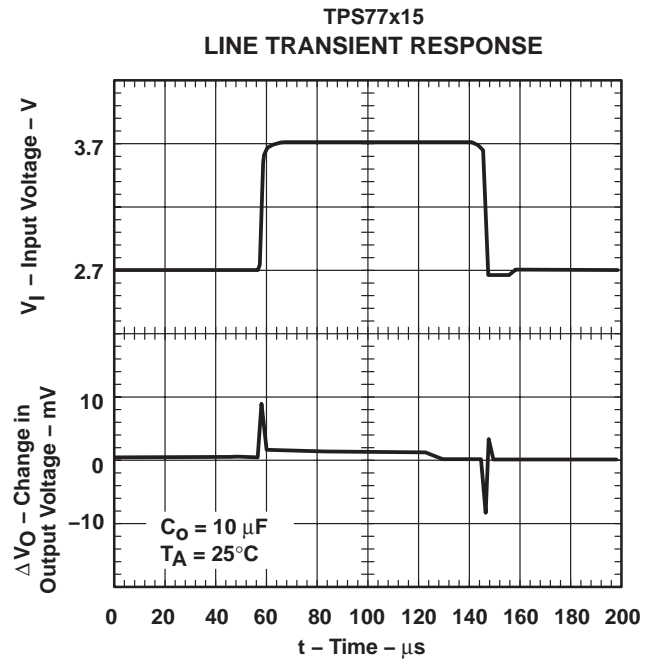
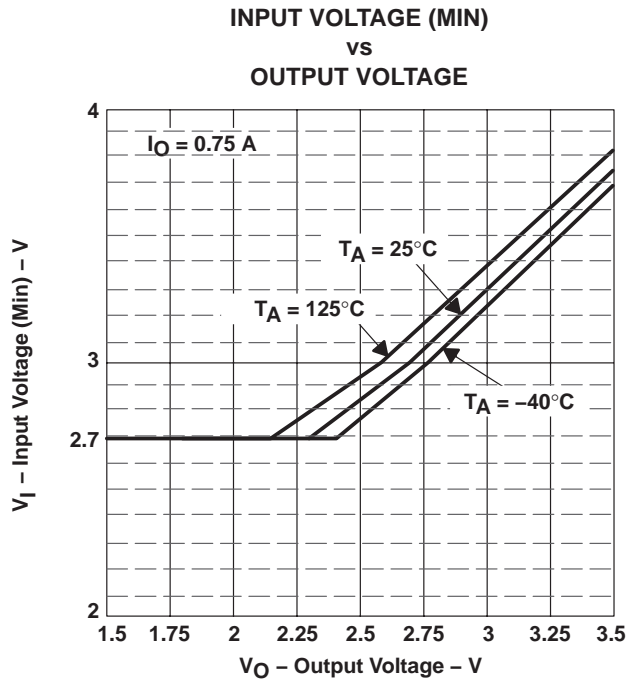

Figure 13

TYPICAL CHARACTERISTICS



TYPICAL CHARACTERISTICS

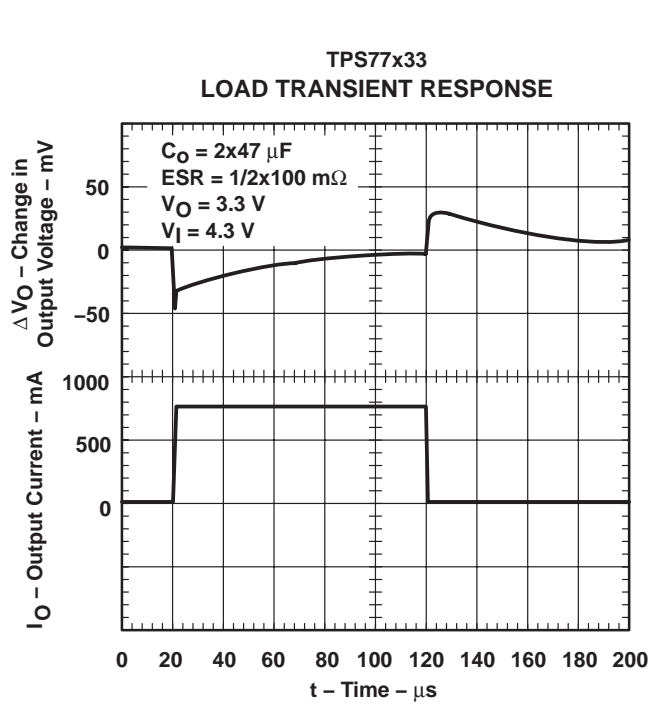

Figure 18

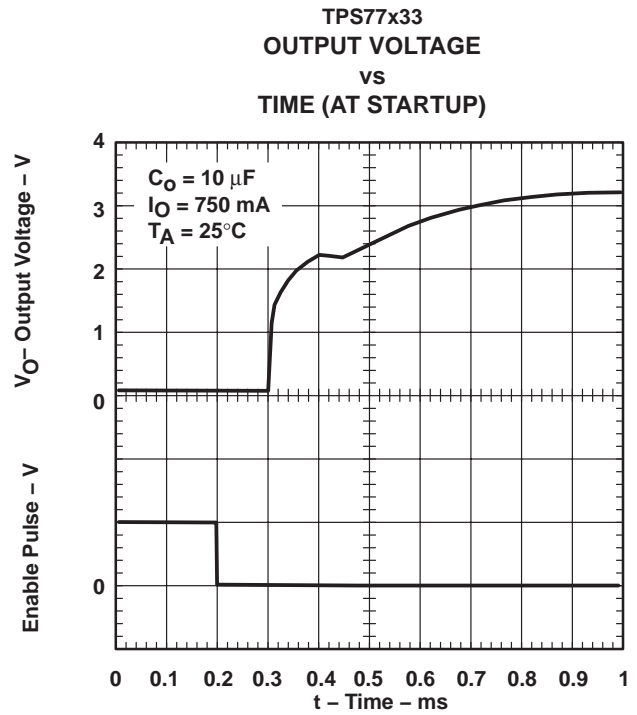

Figure 19

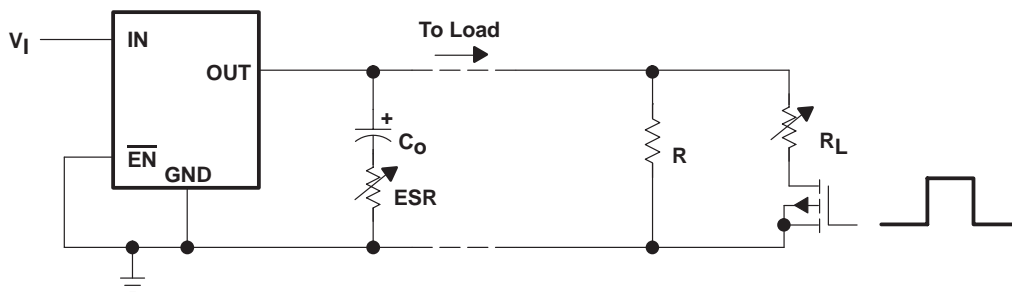

Figure 20. Test Circuit for Typical Regions of Stability (Figures 21 through 24) (Fixed Output Options)

TYPICAL CHARACTERISTICS

TYPICAL REGION OF STABILITY
 EQUIVALENT SERIES RESISTANCE(1)
 vs
 OUTPUT CURRENT

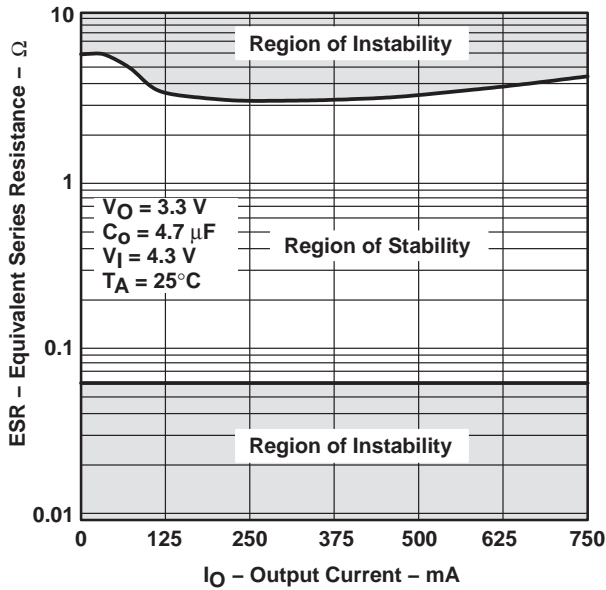

Figure 21

TYPICAL REGION OF STABILITY
 EQUIVALENT SERIES RESISTANCE(1)
 vs
 OUTPUT CURRENT

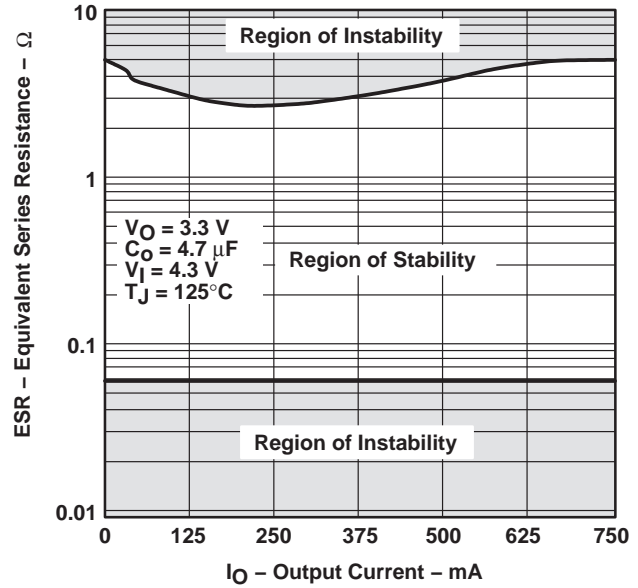

Figure 22

TYPICAL REGION OF STABILITY
 EQUIVALENT SERIES RESISTANCE(1)
 vs
 OUTPUT CURRENT

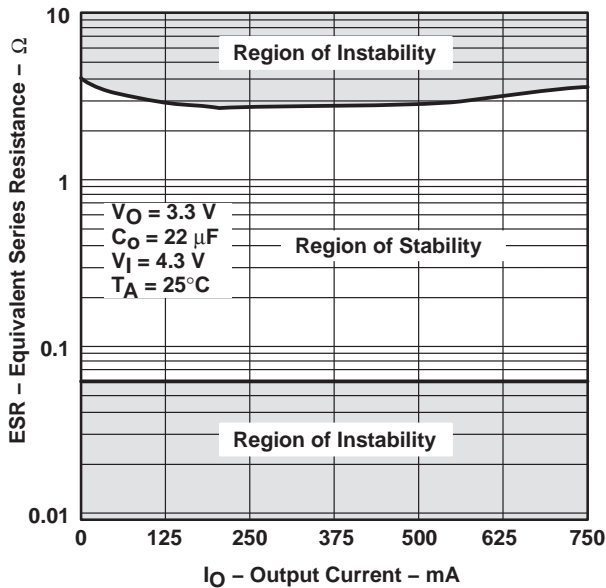

Figure 23

TYPICAL REGION OF STABILITY
 EQUIVALENT SERIES RESISTANCE(1)
 vs
 OUTPUT CURRENT

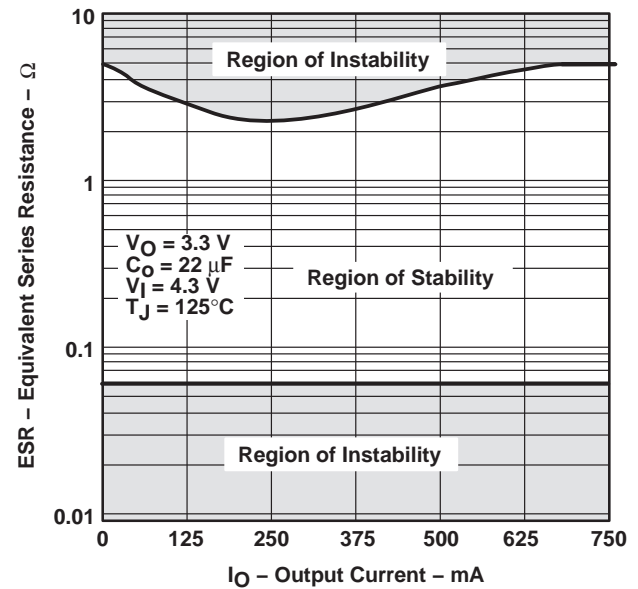

Figure 24

(1) Equivalent series resistance (ESR) refers to the total series resistance, including the ESR of the capacitor, any series resistance added externally, and PWB trace resistance to C_O .

APPLICATION INFORMATION

The TPS777xx and TPS778xx families include four fixed-output voltage regulators (1.5 V, 1.8 V, 2.5 V, and 3.3 V), and an adjustable regulator, the TPS77x01 (adjustable from 1.5 V to 5.5 V for TPS77701 option and 1.2 V to 5.5 V for TPS77801 option).

device operation

The TPS777xx and TPS778xx feature very low quiescent current, which remains virtually constant even with varying loads. Conventional LDO regulators use a pnp pass element, the base current of which is directly proportional to the load current through the regulator ($I_B = I_C/\beta$). The TPS777xx and TPS778xx use a PMOS transistor to pass current; because the gate of the PMOS is voltage driven, operating current is low and invariable over the full load range.

Another pitfall associated with the pnp-pass element is its tendency to saturate when the device goes into dropout. The resulting drop in β forces an increase in I_B to maintain the load. During power up, this translates to large start-up currents. Systems with limited supply current may fail to start up. In battery-powered systems, it means rapid battery discharge when the voltage decays below the minimum required for regulation. The TPS777xx and TPS778xx quiescent currents remain low even when the regulator drops out, eliminating both problems.

The TPS777xx and TPS778xx families also feature a shutdown mode that places the output in the high-impedance state (essentially equal to the feedback-divider resistance) and reduces quiescent current to 2 μA . If the shutdown feature is not used, $\overline{\text{EN}}$ should be tied to ground.

minimum load requirements

The TPS777xx and TPS778xx families are stable even at zero load; no minimum load is required for operation.

FB—pin connection (adjustable version only)

The FB pin is an input pin to sense the output voltage and close the loop for the adjustable option. The output voltage is sensed through a resistor divider network to close the loop as it is shown in Figure 26. Normally, this connection should be as short as possible; however, the connection can be made near a critical circuit to improve performance at that point. Internally, FB connects to a high-impedance wide-bandwidth amplifier and noise pickup feeds through to the regulator output. Routing the FB connection to minimize/avoid noise pickup is essential.

external capacitor requirements

An input capacitor is not usually required; however, a ceramic bypass capacitor (0.047 μF or larger) improves load transient response and noise rejection if the TPS777xx or TPS778xx are located more than a few inches from the power supply. A higher-capacitance electrolytic capacitor may be necessary if large (hundreds of milliamps) load transients with fast rise times are anticipated.

Like all low dropout regulators, the TPS777xx and TPS778xx require an output capacitor connected between OUT and GND to stabilize the internal control loop. The minimum recommended capacitance value is 10 μF and the ESR (equivalent series resistance) must be between 50 m Ω and 1.5 Ω . Capacitor values 10 μF or larger are acceptable, provided the ESR is less than 1.5 Ω . Solid tantalum electrolytic, aluminum electrolytic, and multilayer ceramic capacitors are all suitable, provided they meet the requirements described previously.

APPLICATION INFORMATION

external capacitor requirements (continued)

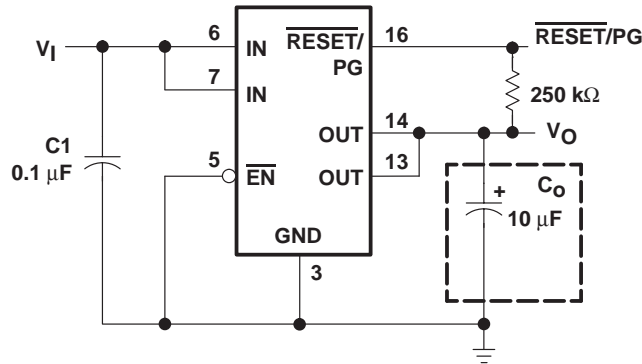

Figure 25. Typical Application Circuit (Fixed Versions)

programming the TPS77x01 adjustable LDO regulator

The output voltage of the TPS77x01 adjustable regulator is programmed using an external resistor divider as shown in Figure 26. The output voltage is calculated using:

$$V_O = V_{\text{ref}} \times \left(1 + \frac{R1}{R2} \right) \tag{1}$$

Where:

$V_{\text{ref}} = 1.1834 \text{ V typ}$ (the internal reference voltage)

Resistors R1 and R2 should be chosen for approximately 10-μA divider current. Lower value resistors can be used but offer no inherent advantage and waste more power. Higher values should be avoided as leakage currents at FB increase the output voltage error. The recommended design procedure is to choose $R2 = 110 \text{ k}\Omega$ to set the divider current at approximately 10 μA and then calculate R1 using:

$$R1 = \left(\frac{V_O}{V_{\text{ref}}} - 1 \right) \times R2 \tag{2}$$

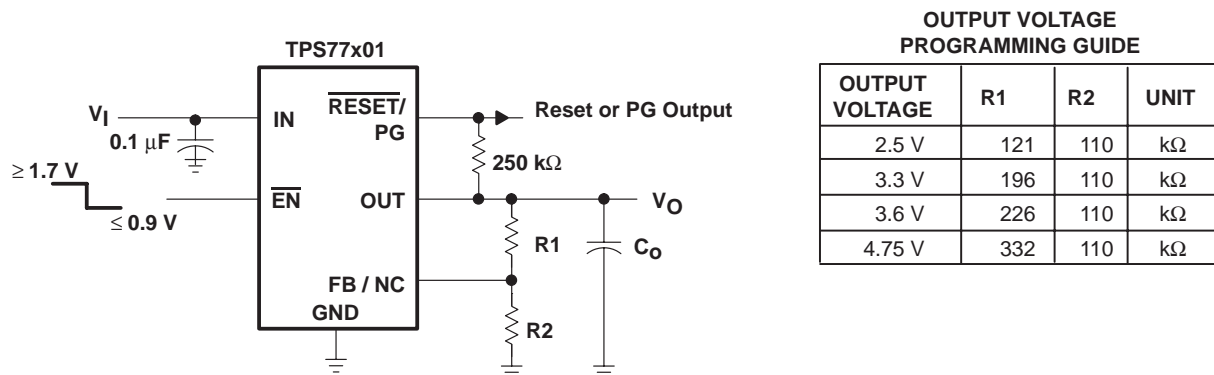

Figure 26. TPS77x01 Adjustable LDO Regulator Programming

APPLICATION INFORMATION

reset indicator

The TPS777xx features a $\overline{\text{RESET}}$ output that can be used to monitor the status of the regulator. The internal comparator monitors the output voltage: when the output drops to between 92% and 98% of its nominal regulated value, the $\overline{\text{RESET}}$ output transistor turns on, taking the signal low. The open-drain output requires a pullup resistor. If not used, it can be left floating. $\overline{\text{RESET}}$ can be used to drive power-on reset circuitry or as a low-battery indicator. $\overline{\text{RESET}}$ does not assert itself when the regulated output voltage falls outside the specified 2% tolerance, but instead reports an output voltage low relative to its nominal regulated value (refer to timing diagram for start-up sequence).

power-good indicator

The TPS778xx features a power-good (PG) output that can be used to monitor the status of the regulator. The internal comparator monitors the output voltage: when the output drops to between 92% and 98% of its nominal regulated value, the PG output transistor turns on, taking the signal low. The open-drain output requires a pullup resistor. If not used, it can be left floating. PG can be used to drive power-on reset circuitry or used as a low-battery indicator.

regulator protection

The TPS777xx and TPS778xx PMOS-pass transistors have a built-in back diode that conducts reverse currents when the input voltage drops below the output voltage (e.g., during power down). Current is conducted from the output to the input and is not internally limited. When extended reverse voltage is anticipated, external limiting may be appropriate.

The TPS777xx and TPS778xx also feature internal current limiting and thermal protection. During normal operation, the TPS777xx and TPS778xx limit output current to approximately 1.7 A. When current limiting engages, the output voltage scales back linearly until the overcurrent condition ends. While current limiting is designed to prevent gross device failure, care should be taken not to exceed the power dissipation ratings of the package. If the temperature of the device exceeds 150°C(typ), thermal-protection circuitry shuts it down. Once the device has cooled below 130°C(typ), regulator operation resumes.

APPLICATION INFORMATION

POWER DISSIPATION AND JUNCTION TEMPERATURE

Specified regulator operation is assured to a junction temperature of 125°C; the maximum junction temperature should be restricted to 125°C under normal operating conditions. This restriction limits the power dissipation the regulator can handle in any given application. To ensure the junction temperature is within acceptable limits, calculate the maximum allowable dissipation, $P_{D(\max)}$, and the actual dissipation, P_D , which must be less than or equal to $P_{D(\max)}$.

The maximum-power-dissipation limit is determined using the following equation:

$$P_{D(\max)} = \frac{T_{J\max} - T_A}{R_{\theta JA}}$$

Where:

$T_{J\max}$ is the maximum allowable junction temperature.

$R_{\theta JA}$ is the thermal resistance junction-to-ambient for the package, and is calculated as

$$\frac{1}{\text{derating factor}} \quad \text{from the dissipation rating tables.}$$

T_A is the ambient temperature.

The regulator dissipation is calculated using:

$$P_D = (V_I - V_O) \times I_O$$

Power dissipation resulting from quiescent current is negligible. Excessive power dissipation will trigger the thermal protection circuit.

PACKAGING INFORMATION

Orderable Device	Status (1)	Package Type	Package Drawing	Pins	Package Qty	Eco Plan (2)	Lead finish/ Ball material (6)	MSL Peak Temp (3)	Op Temp (°C)	Device Marking (4/5)	Samples
TPS77701D	ACTIVE	SOIC	D	8	75	RoHS & Green	NIPDAU	Level-1-260C-UNLIM	-40 to 125	77701	Samples
TPS77701DR	ACTIVE	SOIC	D	8	2500	RoHS & Green	NIPDAU	Level-1-260C-UNLIM	-40 to 125	77701	Samples
TPS77701PWP	ACTIVE	HTSSOP	PWP	20	70	RoHS & Green	NIPDAU	Level-2-260C-1 YEAR	-40 to 125	PT77701	Samples
TPS77701PWPR	ACTIVE	HTSSOP	PWP	20	2000	RoHS & Green	NIPDAU	Level-2-260C-1 YEAR	-40 to 125	PT77701	Samples
TPS77715D	ACTIVE	SOIC	D	8	75	RoHS & Green	NIPDAU	Level-1-260C-UNLIM	-40 to 125	77715	Samples
TPS77715DR	ACTIVE	SOIC	D	8	2500	RoHS & Green	NIPDAU	Level-1-260C-UNLIM	-40 to 125	77715	Samples
TPS77715PWP	ACTIVE	HTSSOP	PWP	20	70	RoHS & Green	NIPDAU	Level-2-260C-1 YEAR	-40 to 125	PT77715	Samples
TPS77715PWPG4	ACTIVE	HTSSOP	PWP	20	70	RoHS & Green	NIPDAU	Level-2-260C-1 YEAR	-40 to 125	PT77715	Samples
TPS77718D	ACTIVE	SOIC	D	8	75	RoHS & Green	NIPDAU	Level-1-260C-UNLIM	-40 to 125	77718	Samples
TPS77718DR	ACTIVE	SOIC	D	8	2500	RoHS & Green	NIPDAU	Level-1-260C-UNLIM	-40 to 125	77718	Samples
TPS77718PWP	ACTIVE	HTSSOP	PWP	20	70	RoHS & Green	NIPDAU	Level-2-260C-1 YEAR	-40 to 125	PT77718	Samples
TPS77718PWPG4	ACTIVE	HTSSOP	PWP	20	70	RoHS & Green	NIPDAU	Level-2-260C-1 YEAR	-40 to 125	PT77718	Samples
TPS77718PWPR	ACTIVE	HTSSOP	PWP	20	2000	RoHS & Green	NIPDAU	Level-2-260C-1 YEAR	-40 to 125	PT77718	Samples
TPS77725D	ACTIVE	SOIC	D	8	75	RoHS & Green	NIPDAU	Level-1-260C-UNLIM	-40 to 125	77725	Samples
TPS77725PWP	ACTIVE	HTSSOP	PWP	20	70	RoHS & Green	NIPDAU	Level-2-260C-1 YEAR	-40 to 125	PT77725	Samples
TPS77725PWPR	ACTIVE	HTSSOP	PWP	20	2000	RoHS & Green	NIPDAU	Level-2-260C-1 YEAR	-40 to 125	PT77725	Samples
TPS77733D	ACTIVE	SOIC	D	8	75	RoHS & Green	NIPDAU	Level-1-260C-UNLIM	-40 to 125	77733	Samples
TPS77733DR	ACTIVE	SOIC	D	8	2500	RoHS & Green	NIPDAU	Level-1-260C-UNLIM	-40 to 125	77733	Samples
TPS77733PWP	ACTIVE	HTSSOP	PWP	20	70	RoHS & Green	NIPDAU	Level-2-260C-1 YEAR	-40 to 125	PT77733	Samples
TPS77733PWPR	ACTIVE	HTSSOP	PWP	20	2000	RoHS & Green	NIPDAU	Level-2-260C-1 YEAR	-40 to 125	PT77733	Samples

Orderable Device	Status (1)	Package Type	Package Drawing	Pins	Package Qty	Eco Plan (2)	Lead finish/ Ball material (6)	MSL Peak Temp (3)	Op Temp (°C)	Device Marking (4/5)	Samples
TPS77801D	ACTIVE	SOIC	D	8	75	RoHS & Green	NIPDAU	Level-1-260C-UNLIM	-40 to 125	77801	Samples
TPS77801DG4	ACTIVE	SOIC	D	8	75	RoHS & Green	NIPDAU	Level-1-260C-UNLIM	-40 to 125	77801	Samples
TPS77801DR	ACTIVE	SOIC	D	8	2500	RoHS & Green	NIPDAU	Level-1-260C-UNLIM	-40 to 125	77801	Samples
TPS77801PWP	ACTIVE	HTSSOP	PWP	20	70	RoHS & Green	NIPDAU	Level-2-260C-1 YEAR	-40 to 125	PT77801	Samples
TPS77801PWPG4	ACTIVE	HTSSOP	PWP	20	70	RoHS & Green	NIPDAU	Level-2-260C-1 YEAR	-40 to 125	PT77801	Samples
TPS77801PWPR	ACTIVE	HTSSOP	PWP	20	2000	RoHS & Green	NIPDAU	Level-2-260C-1 YEAR	-40 to 125	PT77801	Samples
TPS77801PWPRG4	ACTIVE	HTSSOP	PWP	20	2000	RoHS & Green	NIPDAU	Level-2-260C-1 YEAR	-40 to 125	PT77801	Samples
TPS77815D	ACTIVE	SOIC	D	8	75	RoHS & Green	NIPDAU	Level-1-260C-UNLIM	-40 to 125	77815	Samples
TPS77815DR	ACTIVE	SOIC	D	8	2500	RoHS & Green	NIPDAU	Level-1-260C-UNLIM	-40 to 125	77815	Samples
TPS77815PWP	ACTIVE	HTSSOP	PWP	20	70	RoHS & Green	NIPDAU	Level-2-260C-1 YEAR	-40 to 125	PT77815	Samples
TPS77815PWPG4	ACTIVE	HTSSOP	PWP	20	70	RoHS & Green	NIPDAU	Level-2-260C-1 YEAR	-40 to 125	PT77815	Samples
TPS77815PWPR	ACTIVE	HTSSOP	PWP	20	2000	RoHS & Green	NIPDAU	Level-2-260C-1 YEAR	-40 to 125	PT77815	Samples
TPS77818D	ACTIVE	SOIC	D	8	75	RoHS & Green	NIPDAU	Level-1-260C-UNLIM	-40 to 125	77818	Samples
TPS77818PWP	ACTIVE	HTSSOP	PWP	20	70	RoHS & Green	NIPDAU	Level-2-260C-1 YEAR	-40 to 125	PT77818	Samples
TPS77818PWPG4	ACTIVE	HTSSOP	PWP	20	70	RoHS & Green	NIPDAU	Level-2-260C-1 YEAR	-40 to 125	PT77818	Samples
TPS77818PWPR	ACTIVE	HTSSOP	PWP	20	2000	RoHS & Green	NIPDAU	Level-2-260C-1 YEAR	-40 to 125	PT77818	Samples
TPS77825D	ACTIVE	SOIC	D	8	75	RoHS & Green	NIPDAU	Level-1-260C-UNLIM	-40 to 125	77825	Samples
TPS77825DR	ACTIVE	SOIC	D	8	2500	RoHS & Green	NIPDAU	Level-1-260C-UNLIM	-40 to 125	77825	Samples
TPS77825PWP	ACTIVE	HTSSOP	PWP	20	70	RoHS & Green	NIPDAU	Level-2-260C-1 YEAR	-40 to 125	PT77825	Samples
TPS77825PWPR	ACTIVE	HTSSOP	PWP	20	2000	RoHS & Green	NIPDAU	Level-2-260C-1 YEAR	-40 to 125	PT77825	Samples
TPS77833D	ACTIVE	SOIC	D	8	75	RoHS & Green	NIPDAU	Level-1-260C-UNLIM	-40 to 125	77833	Samples

Orderable Device	Status (1)	Package Type	Package Drawing	Pins	Package Qty	Eco Plan (2)	Lead finish/ Ball material (6)	MSL Peak Temp (3)	Op Temp (°C)	Device Marking (4/5)	Samples
TPS77833DR	ACTIVE	SOIC	D	8	2500	RoHS & Green	NIPDAU	Level-1-260C-UNLIM	-40 to 125	77833	Samples
TPS77833PWP	ACTIVE	HTSSOP	PWP	20	70	RoHS & Green	NIPDAU	Level-2-260C-1 YEAR	-40 to 125	PT77833	Samples
TPS77833PWPR	ACTIVE	HTSSOP	PWP	20	2000	RoHS & Green	NIPDAU	Level-2-260C-1 YEAR	-40 to 125	PT77833	Samples

(1) The marketing status values are defined as follows:

ACTIVE: Product device recommended for new designs.

LIFEBUY: TI has announced that the device will be discontinued, and a lifetime-buy period is in effect.

NRND: Not recommended for new designs. Device is in production to support existing customers, but TI does not recommend using this part in a new design.

PREVIEW: Device has been announced but is not in production. Samples may or may not be available.

OBSELETE: TI has discontinued the production of the device.

(2) **RoHS:** TI defines "RoHS" to mean semiconductor products that are compliant with the current EU RoHS requirements for all 10 RoHS substances, including the requirement that RoHS substance do not exceed 0.1% by weight in homogeneous materials. Where designed to be soldered at high temperatures, "RoHS" products are suitable for use in specified lead-free processes. TI may reference these types of products as "Pb-Free".

RoHS Exempt: TI defines "RoHS Exempt" to mean products that contain lead but are compliant with EU RoHS pursuant to a specific EU RoHS exemption.

Green: TI defines "Green" to mean the content of Chlorine (Cl) and Bromine (Br) based flame retardants meet JS709B low halogen requirements of <=1000ppm threshold. Antimony trioxide based flame retardants must also meet the <=1000ppm threshold requirement.

(3) MSL, Peak Temp. - The Moisture Sensitivity Level rating according to the JEDEC industry standard classifications, and peak solder temperature.

(4) There may be additional marking, which relates to the logo, the lot trace code information, or the environmental category on the device.

(5) Multiple Device Markings will be inside parentheses. Only one Device Marking contained in parentheses and separated by a "-" will appear on a device. If a line is indented then it is a continuation of the previous line and the two combined represent the entire Device Marking for that device.

(6) Lead finish/Ball material - Orderable Devices may have multiple material finish options. Finish options are separated by a vertical ruled line. Lead finish/Ball material values may wrap to two lines if the finish value exceeds the maximum column width.

Important Information and Disclaimer:The information provided on this page represents TI's knowledge and belief as of the date that it is provided. TI bases its knowledge and belief on information provided by third parties, and makes no representation or warranty as to the accuracy of such information. Efforts are underway to better integrate information from third parties. TI has taken and continues to take reasonable steps to provide representative and accurate information but may not have conducted destructive testing or chemical analysis on incoming materials and chemicals. TI and TI suppliers consider certain information to be proprietary, and thus CAS numbers and other limited information may not be available for release.

In no event shall TI's liability arising out of such information exceed the total purchase price of the TI part(s) at issue in this document sold by TI to Customer on an annual basis.

TAPE AND REEL INFORMATION

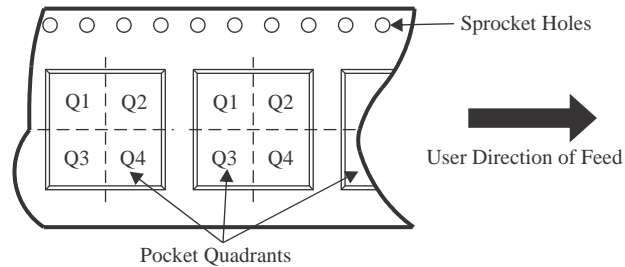
QUADRANT ASSIGNMENTS FOR PIN 1 ORIENTATION IN TAPE

*All dimensions are nominal

Device	Package Type	Package Drawing	Pins	SPQ	Reel Diameter (mm)	Reel Width W1 (mm)	A0 (mm)	B0 (mm)	K0 (mm)	P1 (mm)	W (mm)	Pin1 Quadrant
TPS77701DR	SOIC	D	8	2500	330.0	12.4	6.4	5.2	2.1	8.0	12.0	Q1
TPS77701PWPR	HTSSOP	PWP	20	2000	330.0	16.4	6.95	7.1	1.6	8.0	16.0	Q1
TPS77715DR	SOIC	D	8	2500	330.0	12.4	6.4	5.2	2.1	8.0	12.0	Q1
TPS77718DR	SOIC	D	8	2500	330.0	12.4	6.4	5.2	2.1	8.0	12.0	Q1
TPS77718PWPR	HTSSOP	PWP	20	2000	330.0	16.4	6.95	7.1	1.6	8.0	16.0	Q1
TPS77725PWPR	HTSSOP	PWP	20	2000	330.0	16.4	6.95	7.1	1.6	8.0	16.0	Q1
TPS77733DR	SOIC	D	8	2500	330.0	12.4	6.4	5.2	2.1	8.0	12.0	Q1
TPS77733PWPR	HTSSOP	PWP	20	2000	330.0	16.4	6.95	7.1	1.6	8.0	16.0	Q1
TPS77801DR	SOIC	D	8	2500	330.0	12.4	6.4	5.2	2.1	8.0	12.0	Q1
TPS77801PWPR	HTSSOP	PWP	20	2000	330.0	16.4	6.95	7.1	1.6	8.0	16.0	Q1
TPS77815DR	SOIC	D	8	2500	330.0	12.4	6.4	5.2	2.1	8.0	12.0	Q1
TPS77815PWPR	HTSSOP	PWP	20	2000	330.0	16.4	6.95	7.1	1.6	8.0	16.0	Q1
TPS77818PWPR	HTSSOP	PWP	20	2000	330.0	16.4	6.95	7.1	1.6	8.0	16.0	Q1
TPS77825DR	SOIC	D	8	2500	330.0	12.4	6.4	5.2	2.1	8.0	12.0	Q1
TPS77825PWPR	HTSSOP	PWP	20	2000	330.0	16.4	6.95	7.1	1.6	8.0	16.0	Q1
TPS77833DR	SOIC	D	8	2500	330.0	12.4	6.4	5.2	2.1	8.0	12.0	Q1

Device	Package Type	Package Drawing	Pins	SPQ	Reel Diameter (mm)	Reel Width W1 (mm)	A0 (mm)	B0 (mm)	K0 (mm)	P1 (mm)	W (mm)	Pin1 Quadrant
TPS77833PWPR	HTSSOP	PWP	20	2000	330.0	16.4	6.95	7.1	1.6	8.0	16.0	Q1

TAPE AND REEL BOX DIMENSIONS

*All dimensions are nominal

Device	Package Type	Package Drawing	Pins	SPQ	Length (mm)	Width (mm)	Height (mm)
TPS77701DR	SOIC	D	8	2500	350.0	350.0	43.0
TPS77701PWPR	HTSSOP	PWP	20	2000	356.0	356.0	35.0
TPS77715DR	SOIC	D	8	2500	350.0	350.0	43.0
TPS77718DR	SOIC	D	8	2500	350.0	350.0	43.0
TPS77718PWPR	HTSSOP	PWP	20	2000	350.0	350.0	43.0
TPS77725PWPR	HTSSOP	PWP	20	2000	350.0	350.0	43.0
TPS77733DR	SOIC	D	8	2500	350.0	350.0	43.0
TPS77733PWPR	HTSSOP	PWP	20	2000	350.0	350.0	43.0
TPS77801DR	SOIC	D	8	2500	350.0	350.0	43.0
TPS77801PWPR	HTSSOP	PWP	20	2000	350.0	350.0	43.0
TPS77815DR	SOIC	D	8	2500	350.0	350.0	43.0
TPS77815PWPR	HTSSOP	PWP	20	2000	350.0	350.0	43.0
TPS77818PWPR	HTSSOP	PWP	20	2000	350.0	350.0	43.0
TPS77825DR	SOIC	D	8	2500	350.0	350.0	43.0
TPS77825PWPR	HTSSOP	PWP	20	2000	350.0	350.0	43.0
TPS77833DR	SOIC	D	8	2500	350.0	350.0	43.0
TPS77833PWPR	HTSSOP	PWP	20	2000	350.0	350.0	43.0

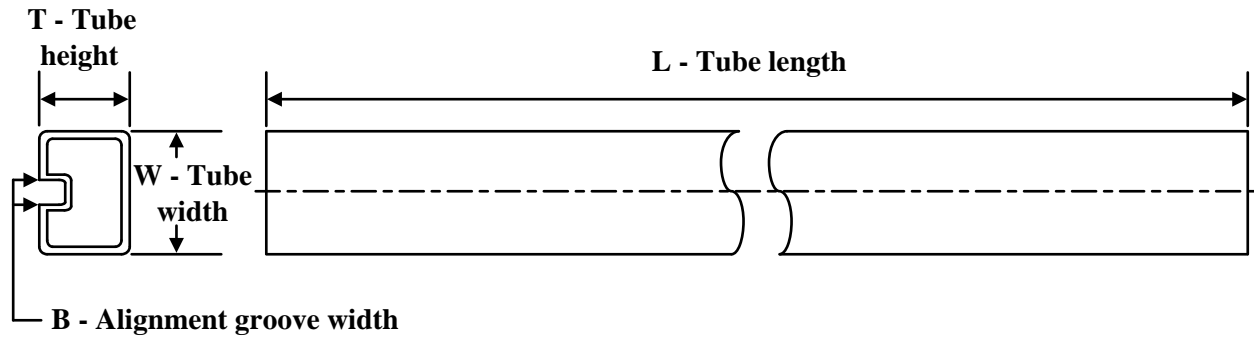
TUBE

*All dimensions are nominal

Device	Package Name	Package Type	Pins	SPQ	L (mm)	W (mm)	T (μm)	B (mm)
TPS77701D	D	SOIC	8	75	505.46	6.76	3810	4
TPS77701PWP	PWP	HTSSOP	20	70	530	10.2	3600	3.5
TPS77715D	D	SOIC	8	75	505.46	6.76	3810	4
TPS77715PWP	PWP	HTSSOP	20	70	530	10.2	3600	3.5
TPS77715PWPG4	PWP	HTSSOP	20	70	530	10.2	3600	3.5
TPS77718D	D	SOIC	8	75	505.46	6.76	3810	4
TPS77718PWP	PWP	HTSSOP	20	70	530	10.2	3600	3.5
TPS77718PWPG4	PWP	HTSSOP	20	70	530	10.2	3600	3.5
TPS77725D	D	SOIC	8	75	505.46	6.76	3810	4
TPS77725PWP	PWP	HTSSOP	20	70	530	10.2	3600	3.5
TPS77733D	D	SOIC	8	75	505.46	6.76	3810	4
TPS77733PWP	PWP	HTSSOP	20	70	530	10.2	3600	3.5
TPS77801D	D	SOIC	8	75	505.46	6.76	3810	4
TPS77801DG4	D	SOIC	8	75	505.46	6.76	3810	4
TPS77801PWP	PWP	HTSSOP	20	70	530	10.2	3600	3.5
TPS77801PWPG4	PWP	HTSSOP	20	70	530	10.2	3600	3.5
TPS77815D	D	SOIC	8	75	505.46	6.76	3810	4
TPS77815PWP	PWP	HTSSOP	20	70	530	10.2	3600	3.5
TPS77815PWPG4	PWP	HTSSOP	20	70	530	10.2	3600	3.5
TPS77818D	D	SOIC	8	75	505.46	6.76	3810	4
TPS77818PWP	PWP	HTSSOP	20	70	530	10.2	3600	3.5
TPS77818PWPG4	PWP	HTSSOP	20	70	530	10.2	3600	3.5
TPS77825D	D	SOIC	8	75	505.46	6.76	3810	4
TPS77825PWP	PWP	HTSSOP	20	70	530	10.2	3600	3.5
TPS77833D	D	SOIC	8	75	505.46	6.76	3810	4
TPS77833PWP	PWP	HTSSOP	20	70	530	10.2	3600	3.5

IMPORTANT NOTICE AND DISCLAIMER

TI PROVIDES TECHNICAL AND RELIABILITY DATA (INCLUDING DATA SHEETS), DESIGN RESOURCES (INCLUDING REFERENCE DESIGNS), APPLICATION OR OTHER DESIGN ADVICE, WEB TOOLS, SAFETY INFORMATION, AND OTHER RESOURCES "AS IS" AND WITH ALL FAULTS, AND DISCLAIMS ALL WARRANTIES, EXPRESS AND IMPLIED, INCLUDING WITHOUT LIMITATION ANY IMPLIED WARRANTIES OF MERCHANTABILITY, FITNESS FOR A PARTICULAR PURPOSE OR NON-INFRINGEMENT OF THIRD PARTY INTELLECTUAL PROPERTY RIGHTS.

These resources are intended for skilled developers designing with TI products. You are solely responsible for (1) selecting the appropriate TI products for your application, (2) designing, validating and testing your application, and (3) ensuring your application meets applicable standards, and any other safety, security, regulatory or other requirements.

These resources are subject to change without notice. TI grants you permission to use these resources only for development of an application that uses the TI products described in the resource. Other reproduction and display of these resources is prohibited. No license is granted to any other TI intellectual property right or to any third party intellectual property right. TI disclaims responsibility for, and you will fully indemnify TI and its representatives against, any claims, damages, costs, losses, and liabilities arising out of your use of these resources.

TI's products are provided subject to [TI's Terms of Sale](#) or other applicable terms available either on [ti.com](https://www.ti.com) or provided in conjunction with such TI products. TI's provision of these resources does not expand or otherwise alter TI's applicable warranties or warranty disclaimers for TI products.

TI objects to and rejects any additional or different terms you may have proposed.

Mailing Address: Texas Instruments, Post Office Box 655303, Dallas, Texas 75265
Copyright © 2023, Texas Instruments Incorporated

Looking for pricing, stock, or lifecycle information?

Click below to explore more details on WIN SOURCE:

 [View TPS77825PWPR on WIN SOURCE](#)

 [Texas Instruments](#) Information

Optimize Your Supply Chain with WIN SOURCE Solutions

-  Global Sourcing Solution
-  Obsolete Management
-  Cost Control Management
-  Shortage Management
-  Alternative Solution
-  Excess Inventory Management