



**THE DATASHEET OF
TS1103-50EG6**





A 1µA, 200µV_{OS} Bidirectional Precision Current-Sense Amplifier

FEATURES

- ◆ Ultra-Low Supply Current: 1µA
- ◆ Wide Input Common Mode Range: +2V to +27V
- ◆ Low Input Offset Voltage: 200µV (max)
- ◆ Low Gain Error: 0.6% (max)
- ◆ Voltage Output
- ◆ Four Gain Options Available:
 - TS1103-25: Gain = 25V/V
 - TS1103-50: Gain = 50V/V
 - TS1103-100: Gain = 100V/V
 - TS1103-200: Gain = 200V/V
- ◆ 6-Lead SOT23 Packaging

APPLICATIONS

- Notebook Computers
- Power Management Systems
- Portable/Battery-Powered Systems
- Smart Chargers
- Smart Phones

DESCRIPTION

The TS1103 is the latest addition to the TS1101 family of bidirectional current-sense amplifiers. Consuming a very low 1µA supply current, the TS1103 high-side current-sense amplifiers combine a 200-µV (max) V_{OS} and a 0.6% (max) gain error for cost-sensitive applications. For all high-side bidirectional current-sensing applications, the TS1103s are self-powered and feature a wide input common-mode voltage range from 2V to 27V. A SIGN comparator digital output is also provided that indicates the direction of current flow depending on the external connections to the TS1103's RS+ and RS- input terminals.

The SOT23 package makes the TS1103 an ideal choice for pcb-area-critical, supply-current-conscious, high-accuracy current-sense applications in all battery-powered and portable instruments.

All TS1103s are specified for operation over the -40°C to +105°C extended temperature range.

TYPICAL APPLICATION CIRCUIT

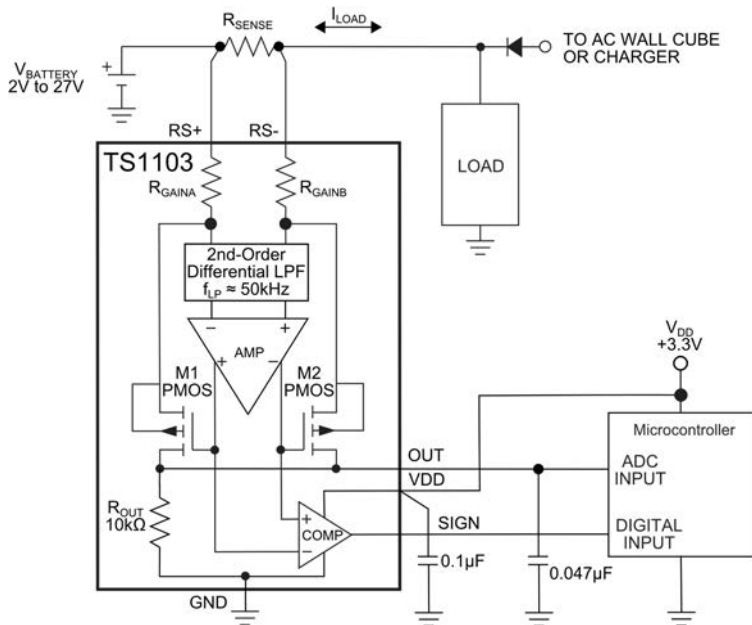

SIGN Comparator's Symmetric I_LOAD Crossover

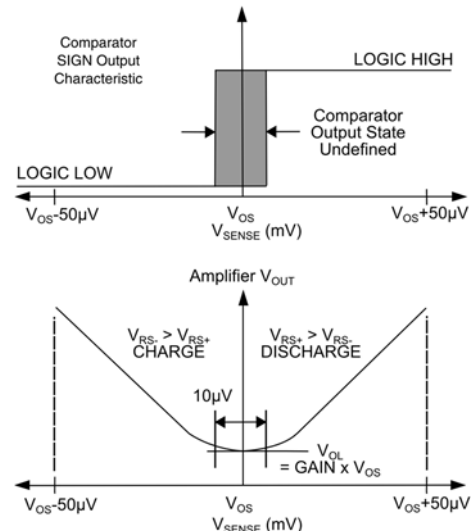

PART	GAIN OPTION
TS1103-25	25 V/V
TS1103-50	50 V/V
TS1103-100	100 V/V
TS1103-200	200 V/V

ABSOLUTE MAXIMUM RATINGS

RS+, RS- to GND -0.3V to +27V
 VDD, OUT, SIGN to GND -0.3V to +6
 RS+ to RS- ±28V
 Short-Circuit Duration: OUT to GND Continuous
 Continuous Input Current (Any Pin) ±20mA
 Continuous Power Dissipation (T_A = +70°C)
 6-Lead SOT23 (Derate at 4.5mW/°C above +70°C)
 360mW

Operating Temperature Range -40°C to +105°C
 Junction Temperature +150°C
 Storage Temperature Range -65°C to +150°C
 Lead Temperature (Soldering, 10s) +300°C
 Soldering Temperature (Reflow) +260°C

Electrical and thermal stresses beyond those listed under “Absolute Maximum Ratings” may cause permanent damage to the device. These are stress ratings only and functional operation of the device at these or any other condition beyond those indicated in the operational sections of the specifications is not implied. Exposure to any absolute maximum rating conditions for extended periods may affect device reliability and lifetime.

PACKAGE/ORDERING INFORMATION

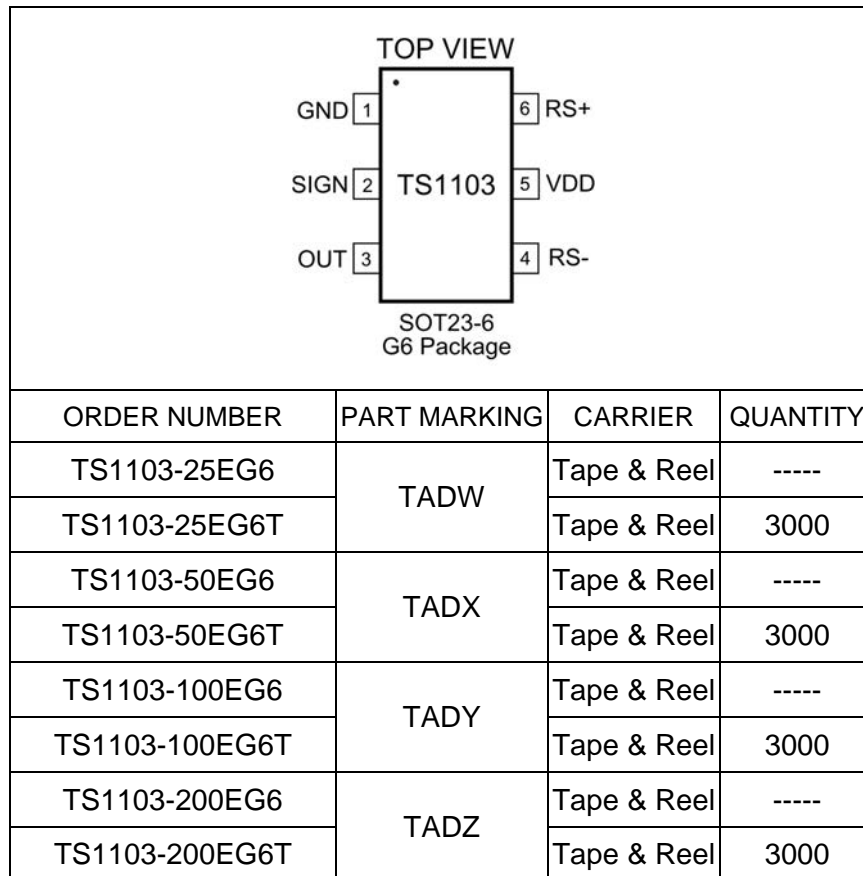

Lead-free Program: Silicon Labs supplies only lead-free packaging.

Consult Silicon Labs for products specified with wider operating temperature ranges.

ELECTRICAL CHARACTERISTICS

$V_{RS+} = 3.6V$; $V_{SENSE} = (V_{RS+} - V_{RS-}) = 0V$; $C_{OUT} = 47nF$; $V_{DD} = 1.8V$; $T_A = -40^{\circ}C$ to $+105^{\circ}C$, unless otherwise noted. Typical values are at $T_A = +25^{\circ}C$. See Note 1.

PARAMETER	SYMBOL	CONDITIONS	MIN	TYP	MAX	UNITS
Supply Current (Note 2)	I_{CC}	$T_A = +25^{\circ}C$		0.68	0.85	μA
		$V_{RS+} = 25V$	$T_A = +25^{\circ}C$		1.0	
					1.2	
Common-Mode Input Range	V_{CM}	Guaranteed by CMRR	2		27	V
CURRENT SENSE AMPLIFIER PARAMETERS						
Common-Mode Rejection Ratio	CMRR	$2V < V_{RS+} < 27V$	120	150		dB
Input Offset Voltage (Note 3)	V_{OS}	$T_A = +25^{\circ}C$		± 30	± 200	μV
V_{OS} Hysteresis (Note 4)	V_{HYS}	$T_A = +25^{\circ}C$		10		μV
Gain	G	TS1103-25		25		V/V
		TS1103-50		50		
		TS1103-100		100		
		TS1103-200		200		
Gain Error (Note 5)	GE	$T_A = +25^{\circ}C$		± 0.2	± 0.6	%
Gain Match (Note 5)	GM	$T_A = +25^{\circ}C$		± 0.2	± 0.6	%
Output Resistance (Note 6)	R_{OUT}	TS1103-25/50/100	7.0	10	13.2	k Ω
		TS1103-200	14.0	20	26.4	
OUT Low Voltage	V_{AOL}	Gain = 25			5	mV
		Gain = 50			10	
		Gain = 100			20	
		Gain = 200			40	
OUT High Voltage (Note 7)	V_{AOH}	$V_{OH} = V_{RS-} - V_{OUT}$		0.05	0.2	V
Output Settling Time	t_S	TS1103-25/50/100	1% final value, $V_{OUT} = 3V$	2.2		ms
		TS1103-200		4.3		
SIGN COMPARATOR PARAMETERS						
VDD Supply Voltage Range	V_{DD}		1.25		5.5	V
VDD Supply Current	I_{DD}			0.02	0.2	μA
Output Low Voltage	V_{COL}	$V_{DD} = 1.25V, I_{SINK} = 5\mu A$			0.2	V
		$V_{DD} = 1.8V, I_{SINK} = 35\mu A$				
Output High Voltage	V_{COH}	$V_{DD} = 1.25V, I_{SOURCE} = 5\mu A$	$V_{DD} - 0.2$			V
		$V_{DD} = 1.8V, I_{SOURCE} = 35\mu A$				
Propagation Delay	t_{PD}	$V_{SENSE} = \pm 1mV$		3		ms
		$V_{SENSE} = \pm 10mV$		0.4		

Note 1: All devices are 100% production tested at $T_A = +25^{\circ}C$. All temperature limits are guaranteed by product characterization.

Note 2: Extrapolated to $V_{OUT} = 0$. I_{CC} is the total current into the $RS+$ and the $RS-$ pins.

Note 3: Input offset voltage V_{OS} is extrapolated from a V_{OUT+} measurement with V_{SENSE} set to $+1mV$ and a V_{OUT-} measurement with V_{SENSE} set to $-1mV$; vis-a-viz,

$$\text{Average } V_{OS} = \frac{(V_{OUT-}) - (V_{OUT+})}{2 \times \text{GAIN}}$$

Note 4: Amplitude of V_{SENSE} lower or higher than V_{OS} required to cause the comparator to switch output states.

Note 5: Gain error applies to current flow in either direction and is calculated by applying two values for V_{SENSE} and then calculating the error of the actual slope vs. the ideal transfer characteristic:

For GAIN = 25, the applied V_{SENSE} is 20mV and 120mV.

For GAIN = 50, the applied V_{SENSE} is 10mV and 60mV.

For GAIN = 100, the applied V_{SENSE} is 5mV and 30mV.

For GAIN = 200, the applied V_{SENSE} is 2.5mV and 15mV.

Note 6: The device is stable for any capacitive load at V_{OUT} .

Note 7: V_{OH} is the voltage from V_{RS-} to V_{OUT} with $V_{SENSE} = 3.6V/\text{GAIN}$.

TYPICAL PERFORMANCE CHARACTERISTICS

$V_{RS+} = V_{RS-} = 3.6V$; $T_A = +25^{\circ}C$, unless otherwise noted.

Input Offset Voltage Histogram

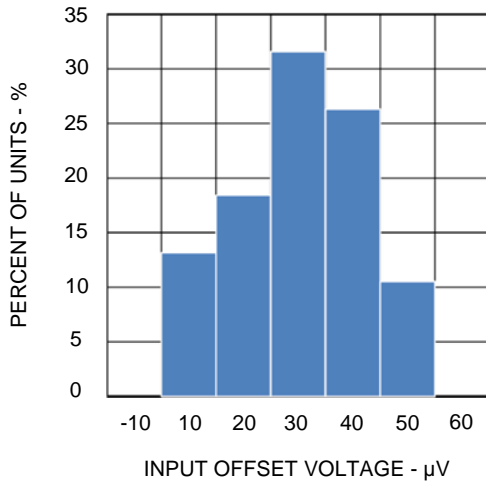

Gain Error Histogram

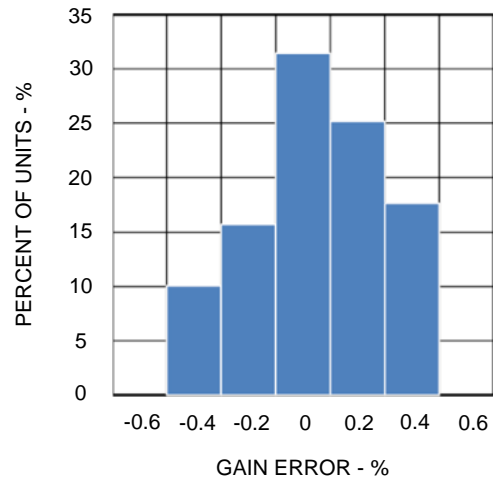

Supply Current vs Temperature

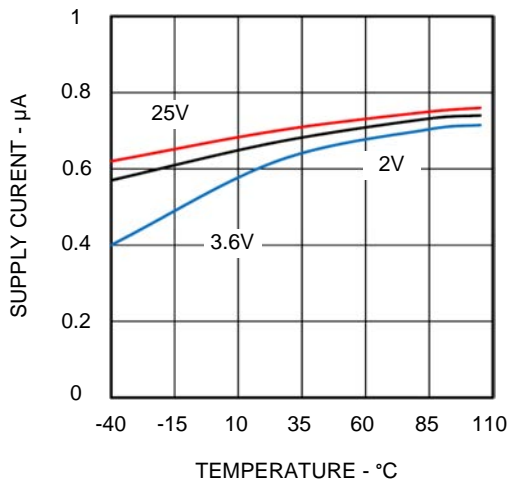

Input Offset Voltage vs Common-Mode Voltage

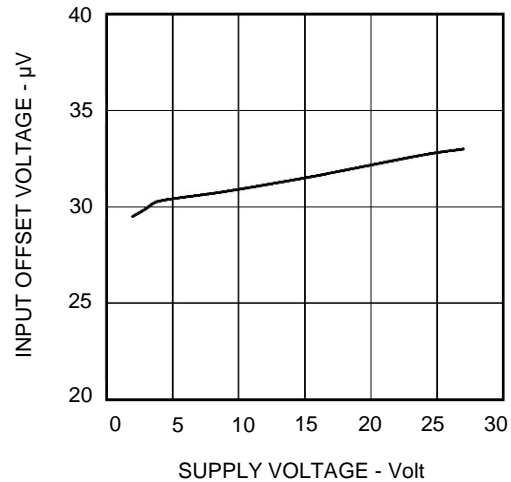

Input Offset Voltage vs Temperature

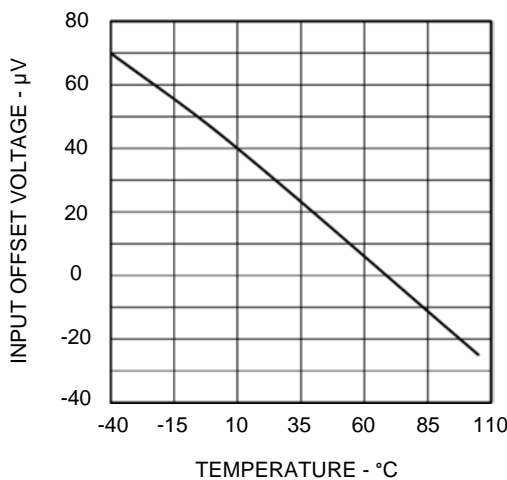

Supply Current vs Common-Mode Voltage

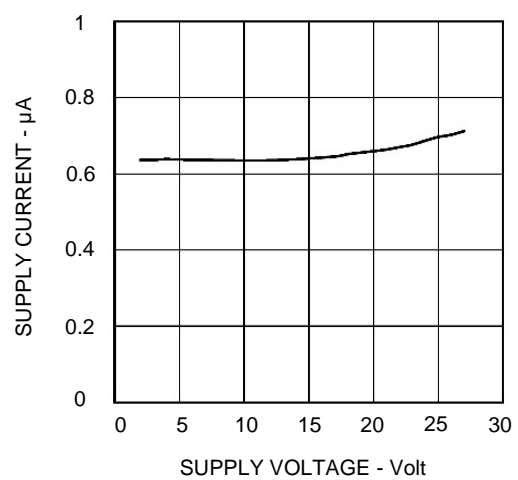



TYPICAL PERFORMANCE CHARACTERISTICS

$V_{RS+} = V_{RS-} = 3.6V$; $T_A = +25^{\circ}C$, unless otherwise noted.

Gain Error vs Common-Mode Voltage

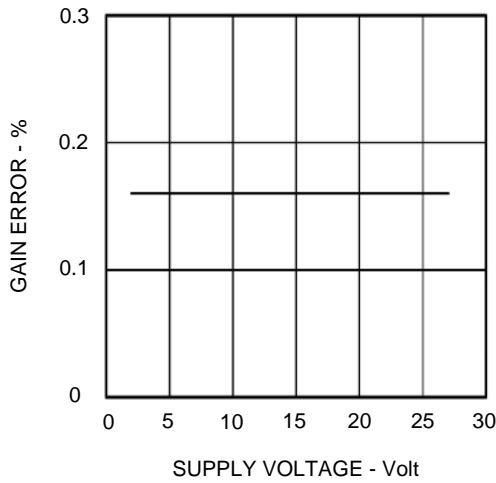

Gain Error vs. Temperature

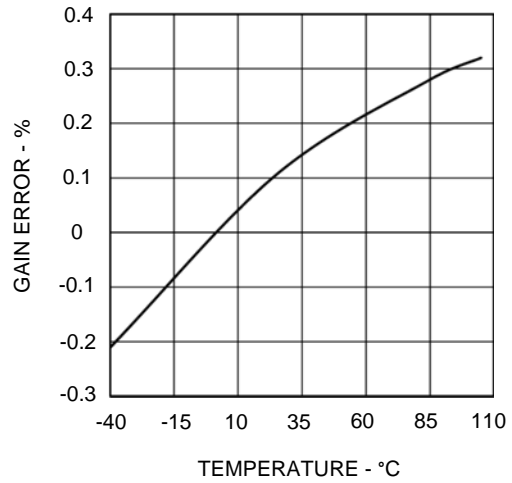

V_{OUT} vs V_{SENSE} @ Supply = 3.6V

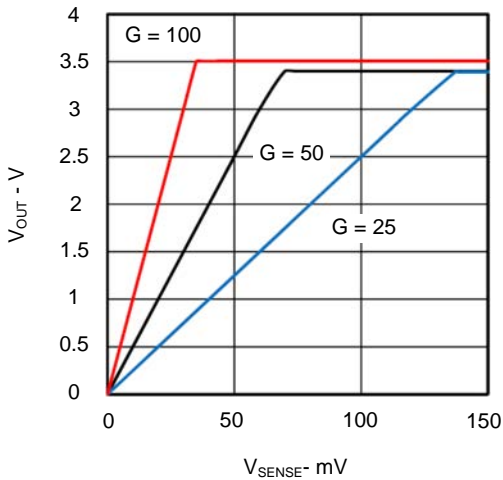

V_{OUT} vs V_{SENSE} @ Supply = 2V

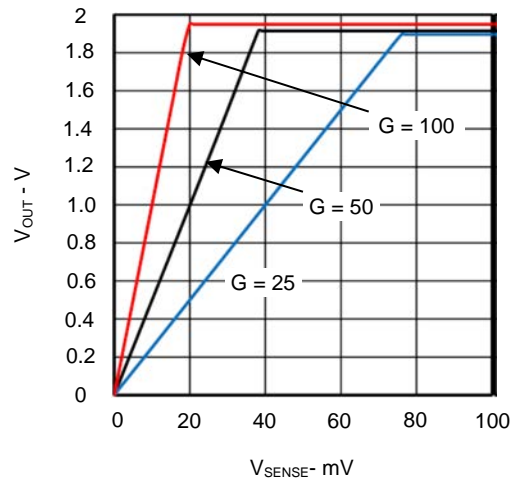

Small-Signal Gain vs Frequency

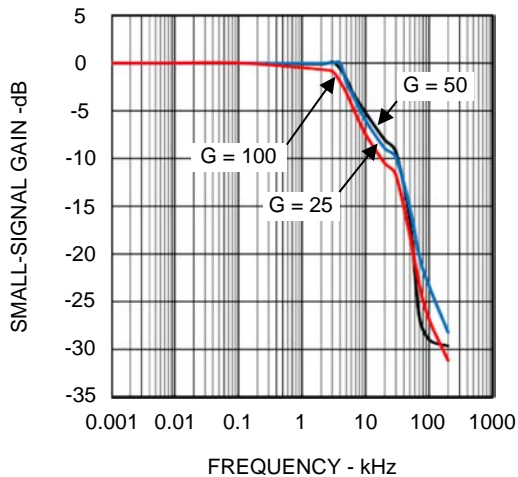

Common-Mode Rejection vs Frequency

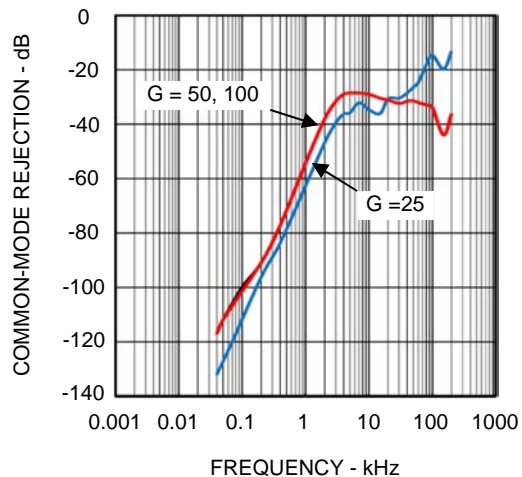

TYPICAL PERFORMANCE CHARACTERISTICS

$V_{RS+} = V_{RS-} = 3.6V$; $C_{OUT} = 0pF$; $T_A = +25^{\circ}C$, unless otherwise noted.

Small-Signal Pulse Response, Gain = 50

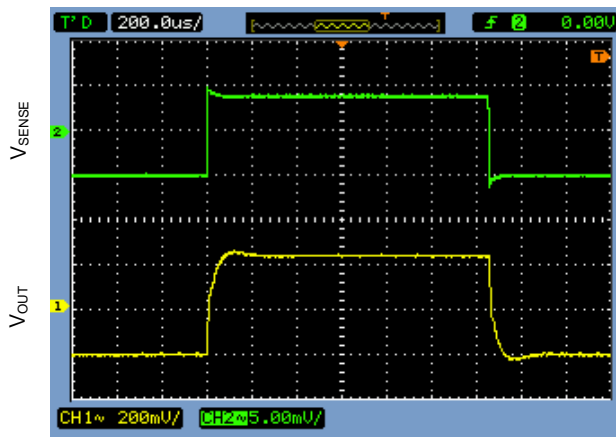

200µs/DIV

Large-Signal Pulse Response, Gain = 50

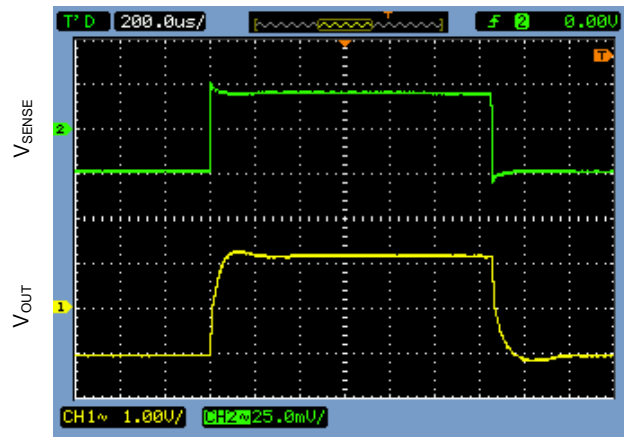

200µs/DIV

Small-Signal Pulse Response, Gain = 25

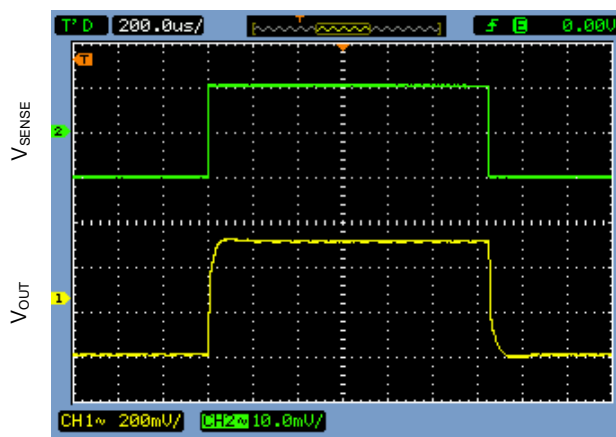

200µs/DIV

Large-Signal Pulse Response, Gain = 25

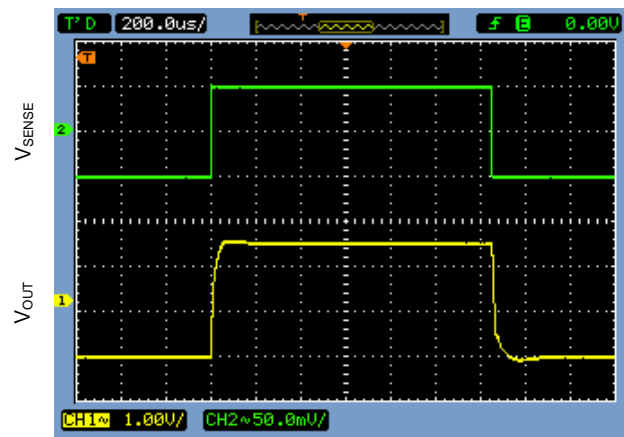

200µs/DIV

Small-Signal Pulse Response, Gain = 100

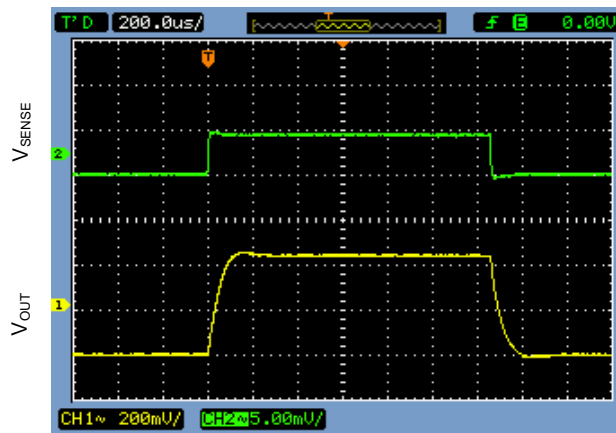

200µs/DIV

Large-Signal Pulse Response, Gain = 100

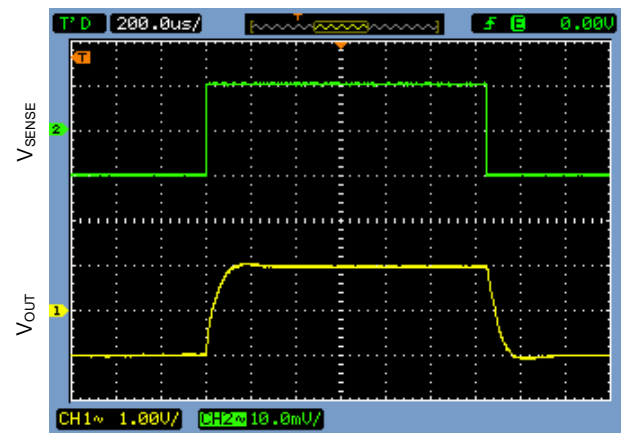

200µs/DIV

PIN FUNCTIONS

PIN	LABEL	FUNCTION
1	GND	Ground. Connect this pin to analog ground.
2	SIGN	Comparator Output, push-pull; SIGN is HIGH for ($V_{RS+} > V_{RS-}$) and LOW for ($V_{RS-} > V_{RS+}$).
3	OUT	Output Voltage. V_{OUT} is proportional to $V_{SENSE} = (V_{RS+} - V_{RS-})$ or $(V_{RS-} - V_{RS+})$.
4	RS-	External Sense Resistor Load-Side Connection
5	VDD	SIGN Comparator External Power Supply Pin; Connect this pin to system's logic VDD supply.
6	RS+	External Sense Resistor Power-Side Connection

BLOCK DIAGRAM

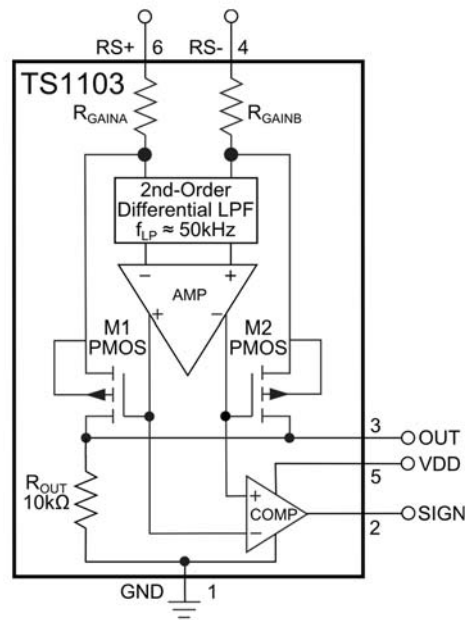

DESCRIPTION OF OPERATION

The internal configuration of the TS1103 – a bidirectional high-side, current-sense amplifier – is a variation of the TS1100 uni-directional current-sense amplifier. In the design of the TS1103, the input amplifier was reconfigured for fully differential input/output operation and a second low-threshold p-channel FET (M2) was added where the drain terminal of M2 is also connected to R_{OUT}. Therefore, the behavior of the TS1103 for when $V_{RS-} > V_{RS+}$ is identical for when $V_{RS+} > V_{RS-}$.

Referring to the typical application circuit on Page 1, the inputs of the TS1103's differential input/output amplifier are connected across an external R_{SENSE} resistor that is used to measure current. At the non-

inverting input of the TS1103 (the RS- terminal), the applied voltage is $I_{LOAD} \times R_{SENSE}$. Since the RS- terminal is the non-inverting input of the internal op amp, op amp feedback action forces the inverting input of the internal op amp to the same potential ($I_{LOAD} \times R_{SENSE}$). Therefore, the voltage drop across R_{SENSE} ($V_{SENSE} = V_{RS+} - V_{RS-}$) and the voltage drop across R_{GAINA} (at the RS+ terminal) are equal. Necessary for gain ratio match, both R_{GAINA} and R_{GAINB} are the same value.

Since p-channel M1's source is connected to the inverting input of the internal op amp and since the voltage drop across R_{GAINA} is the same as the

external V_{SENSE} , op amp feedback action drives the gate of M1 such that M1's drain-source current is equal to:

$$I_{DS(M1)} = \frac{V_{SENSE}}{RGAINA}$$

or

$$I_{DS(M1)} = \frac{I_{LOAD} \times R_{SENSE}}{RGAINA}$$

Since M1's drain terminal is connected to R_{OUT} , the output voltage of the TS1103 at the OUT terminal is, therefore;

$$V_{OUT} = I_{LOAD} \times R_{SENSE} \times \frac{R_{OUT}}{RGAINA}$$

When the voltage at the $RS-$ terminal is greater than the voltage at the $RS+$ terminal, the external V_{SENSE} voltage drop is impressed upon $RGAINB$. The voltage drop across $RGAINB$ is then converted into a current by M2 that then produces an output voltage across R_{OUT} . In this design, when M1 is conducting current ($V_{RS+} > V_{RS-}$), the TS1103's internal amplifier holds M2 OFF. When M2 is conducting current ($V_{RS-} > V_{RS+}$), the internal amplifier holds M1 OFF. In either case, the disabled FET does not contribute to the resultant output voltage.

The current-sense amplifier's gain accuracy is therefore the ratio match of R_{OUT} to $RGAIN[A/B]$. For each of the four gain options available, Table 1 lists the values for R_{OUT} and $RGAIN[A/B]$. The TS1103's output stage is protected against input overdrive by use of an output current-limiting circuit of 3mA (typical) and a 7V internal clamp protection circuit.

Table 1: Internal Gain Setting Resistors (Typical Values)

GAIN (V/V)	RGAIN[A/B] (Ω)	R_{OUT} (Ω)	Part Number
25	400	10k	TS1103-25
50	200	10k	TS1103-50
100	100	10k	TS1103-100
200	100	20k	TS1103-200

The SIGN Comparator Output

As shown in the TS1103's block diagram, the design of the TS1103 incorporated one additional feature – an analog comparator the inputs of which monitor the internal amplifier's differential output voltage. While the voltage at the TS1103's OUT terminal

indicates the magnitude of the load current, the TS1103's SIGN output indicates the load current's direction. The SIGN output is a logic high when M1 is conducting current ($V_{RS+} > V_{RS-}$). Alternatively, the SIGN output is a logic low when M2 is conducting current ($V_{RS+} < V_{RS-}$). The SIGN comparator's transfer characteristic is illustrated in Figure 1. Unlike other current-sense amplifiers that implement a $OUT/SIGN$ arrangement, the TS1103 exhibits no "dead zone" at I_{LOAD} switchover.

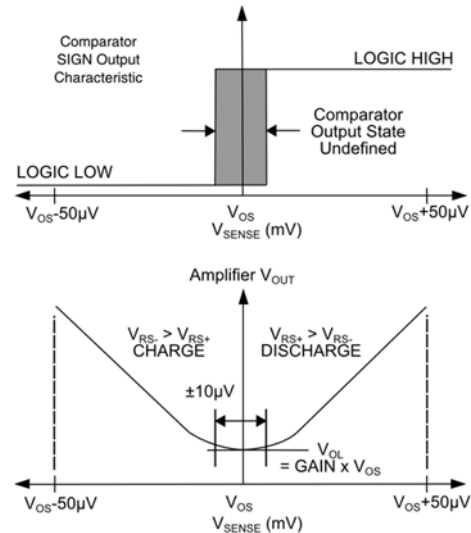

Figure 1: TS1103's SIGN Comparator Transfer Characteristic.

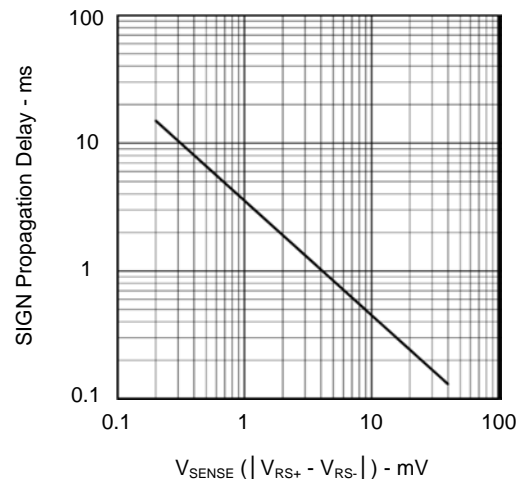

Figure 2: SIGN Comparator Propagation Delay vs V_{SENSE} .

The other attribute of the SIGN comparator's behavior is its propagation delay as a function of applied V_{SENSE} [($V_{RS+} - V_{RS-}$) or ($V_{RS-} - V_{RS+}$)]. As shown in Figure 2, the SIGN comparator's

propagation delay behavior is symmetric regardless of current-flow direction and is inversely proportional to V_{SENSE} .

APPLICATIONS INFORMATION

Choosing the Sense Resistor

Selecting the optimal value for the external R_{SENSE} is based on the following criteria and for each commentary follows:

- 1) R_{SENSE} Voltage Loss
- 2) V_{OUT} Swing vs. Applied Input Voltage at V_{RS+} and Desired V_{SENSE}
- 3) Total I_{LOAD} Accuracy
- 4) Circuit Efficiency and Power Dissipation
- 5) R_{SENSE} Kelvin Connections

1) R_{SENSE} Voltage Loss

For lowest IR power dissipation in R_{SENSE} , the smallest usable resistor value for R_{SENSE} should be selected.

2) V_{OUT} Swing vs. Applied Input Voltage at V_{RS+} and Desired V_{SENSE}

As there is no separate power supply pin for the TS1103, the circuit draws its power from the voltage at its $RS+$ and $RS-$ terminals. Therefore, the signal voltage at the OUT terminal is bounded by the minimum voltage applied at the $RS+$ terminal.

Therefore,

$$V_{OUT(max)} = V_{RS+(min)} - V_{SENSE(max)} - V_{OH(max)}$$

and

$$R_{SENSE} < \frac{V_{OUT(max)}}{GAIN \times I_{LOAD(max)}}$$

where the full-scale V_{SENSE} should be less than $V_{OUT(max)}/GAIN$ at the application's minimum $RS+$ terminal voltage. For best performance with a 3.6V power supply, R_{SENSE} should be chosen to generate a V_{SENSE} of: a) 120mV (for the 25V/V GAIN option), b) 60mV (for the 50V/V GAIN option), c) 30mV (for the 100V/V GAIN option), or d) 15mV (for the 200V/V GAIN option) at the full-scale I_{LOAD} current in each application. For the case where the

minimum power supply voltage is higher than 3.6V, each of the four full-scale V_{SENSE} s above can be increased.

3) Total Load Current Accuracy

In the TS1103's linear region where $V_{OUT} < V_{OUT(max)}$, there are two specifications related to the circuit's accuracy: a) the TS1103's input offset voltage ($V_{OS(max)} = 200\mu V$) and b) its gain error ($GE(max) = 0.6\%$). An expression for the TS1103's total error is given by:

$$V_{OUT} = [GAIN \times (1 \pm GE) \times V_{SENSE}] \pm (GAIN \times V_{OS})$$

A large value for R_{SENSE} permits the use of smaller load currents to be measured more accurately because the effects of offset voltages are less significant when compared to larger V_{SENSE} voltages. Due care though should be exercised as previously mentioned with large values of R_{SENSE} .

4) Circuit Efficiency and Power Dissipation

IR losses in R_{SENSE} can be large especially at high load currents. It is important to select the smallest, usable R_{SENSE} value to minimize power dissipation and to keep the physical size of R_{SENSE} small. If the external R_{SENSE} is allowed to dissipate significant power, then its inherent temperature coefficient may alter its design center value, thereby reducing load current measurement accuracy. Precisely because the TS1103's input stage was designed to exhibit a very low input offset voltage, small R_{SENSE} values can be used to reduce power dissipation and minimize local hot spots on the pcb.

5) R_{SENSE} Kelvin Connections

For optimal V_{SENSE} accuracy in the presence of large load currents, parasitic pcb track resistance should be minimized. Kelvin-sense pcb connections between R_{SENSE} and the TS1103's $RS+$ and $RS-$ terminals are strongly recommended. The drawing in Figure 3 illustrates the connections between the

current-sense amplifier and the current-sense resistor. The pcb layout should be balanced and symmetrical to minimize wiring-induced errors. In addition, the pcb layout for RSENSE should include good thermal management techniques for optimal RSENSE power dissipation.

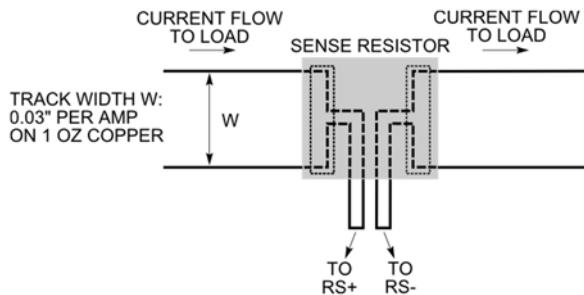

Figure 3: Making PCB Connections to RSENSE.

6) RSENSE Composition

Current-shunt resistors are available in metal film, metal strip, and wire-wound constructions. Wire-wound current-shunt resistors are constructed with wire spirally wound onto a core. As a result, these types of current shunt resistors exhibit the largest self inductance. In applications where the load current contains high-frequency transients, metal film or metal strip current sense resistors are recommended.

Internal Noise Filter

In power management and motor control applications, current-sense amplifiers are required to measure load currents accurately in the presence of both externally-generated differential and common-mode noise. An example of differential-mode noise that can appear at the inputs of a current-sense amplifier is high-frequency ripple. High-frequency ripple – whether injected into the circuit inductively or capacitively - can produce a differential-mode voltage drop across the external current-shunt resistor (RSENSE). An example of externally-generated, common-mode noise is the high-frequency output ripple of a switching regulator that can result in common-mode noise injection into both inputs of a current-sense amplifier.

Even though the load current signal bandwidth is DC, the input stage of any current-sense amplifier can rectify unwanted, out-of-band noise that can result in an apparent error voltage at its output. This

rectification of noise signals occurs because all amplifier input stages are constructed with transistors that can behave as high-frequency signal detectors in the same way pn-junction diodes were used as RF envelope detectors in early radio designs. Against common-mode injected noise, the amplifier's internal common-mode rejection is usually sufficient.

To counter the effects of externally-injected noise, it has always been good engineering practice to add external low-pass filters in series with the inputs of a current-sense amplifier. In the design of discrete current-sense amplifiers, resistors used in the external low-pass filters were incorporated into the circuit's overall design so errors because of any input-bias current-generated offset voltage errors and gain errors were compensated.

With the advent of monolithic current-sense amplifiers, like the TS1103, the addition of external low-pass filters in series with the current-sense amplifier's inputs only introduces additional offset voltage and gain errors. To minimize or eliminate altogether the need for external low-pass filters and to maintain low input offset voltage and gain errors, the TS1103 incorporates a 50-kHz (typ), 2nd-order differential low-pass filter as shown in the TS1103's Block Diagram.

Output Filter Capacitor

If the TS1103 is part of a signal acquisition system where its OUT terminal is connected to the input of an ADC with an internal, switched-capacitor track-and-hold circuit, the internal track-and-hold's sampling capacitor can cause voltage droop at V_{OUT}. A 22nF to 100nF good-quality ceramic capacitor from the OUT terminal to GND forms a low-pass filter with the TS1103's R_{OUT} and should be used to minimize voltage droop (holding V_{OUT} constant during the sample interval. Using a capacitor on the OUT terminal will also reduce the TS1103's small-signal bandwidth as well as band-limiting amplifier noise.

PC Board Layout and Power-Supply Bypassing

For optimal circuit performance, the TS1103 should be in very close proximity to the external current-sense resistor and the pcb tracks from RSENSE to the RS+ and the RS- input terminals of the TS1103 should be short and symmetric. Also recommended are a ground plane and surface mount resistors and capacitors.

PACKAGE OUTLINE DRAWING

6-Pin SOT23 Package Outline Drawing

(N.B., Drawings are not to scale)

Note:

1. \triangle Dimension are exclusive of mold flash and gate burr.
2. Dimension are exclusive of solder plating.
3. The foot length measuring is based on the gauge plane method.
4. Package is surface to be matte finish VDI 11~13.
5. Dimensions and tolerances are as per ANSI Y14.5M, 1982.
6. This part is compliant with EIAJ specification SC74A and JEDEC MO-178 AB spec.
7. Die is facing up for mold, Die is facing down for trim/form, ie. reverse trim/form.
8. All dimensions are in mm.

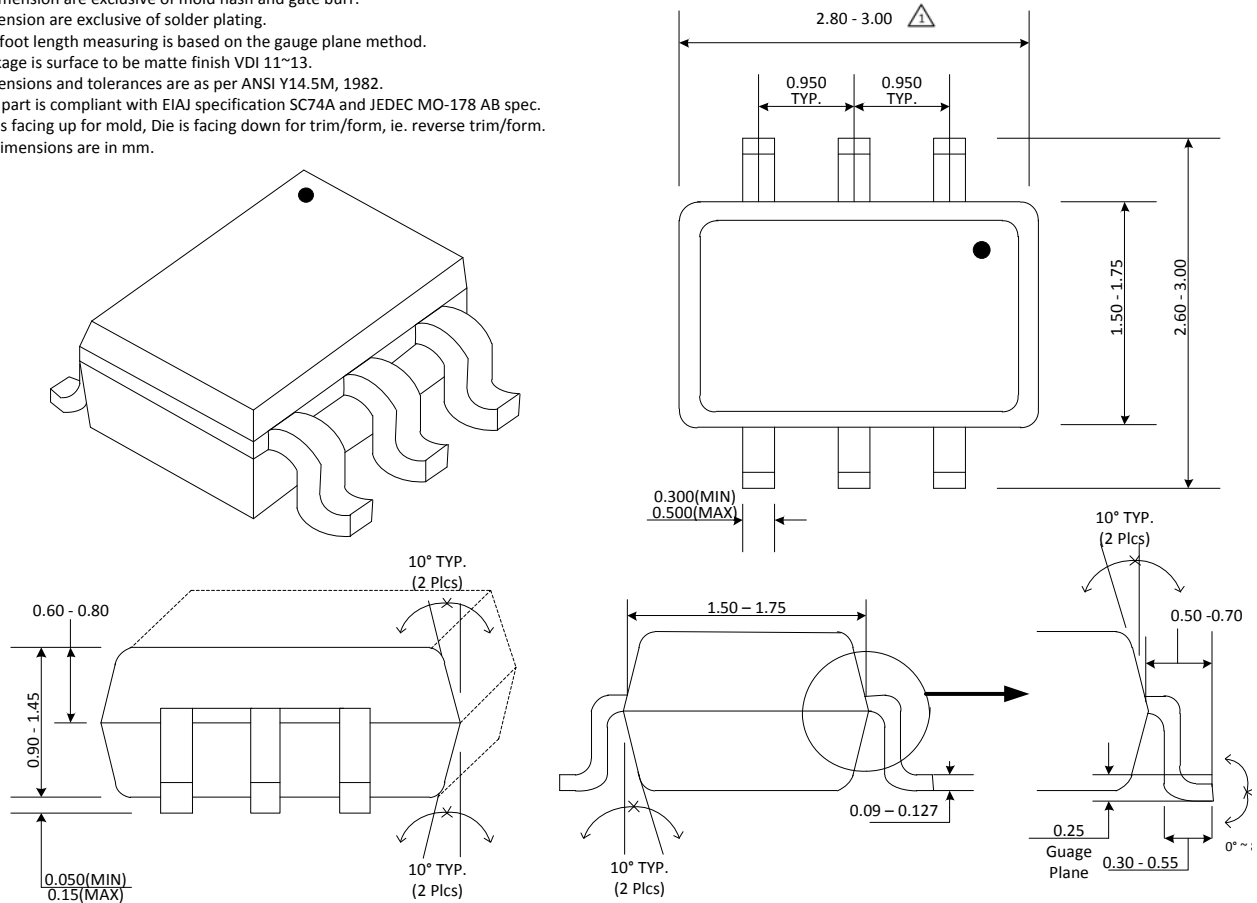

Patent Notice

Silicon Labs invests in research and development to help our customers differentiate in the market with innovative low-power, small size, analog-intensive mixed-signal solutions. Silicon Labs' extensive patent portfolio is a testament to our unique approach and world-class engineering team.

The information in this document is believed to be accurate in all respects at the time of publication but is subject to change without notice. Silicon Laboratories assumes no responsibility for errors and omissions, and disclaims responsibility for any consequences resulting from the use of information included herein. Additionally, Silicon Laboratories assumes no responsibility for the functioning of undescribed features or parameters. Silicon Laboratories reserves the right to make changes without further notice. Silicon Laboratories makes no warranty, representation or guarantee regarding the suitability of its products for any particular purpose, nor does Silicon Laboratories assume any liability arising out of the application or use of any product or circuit, and specifically disclaims any and all liability, including without limitation consequential or incidental damages. Silicon Laboratories products are not designed, intended, or authorized for use in applications intended to support or sustain life, or for any other application in which the failure of the Silicon Laboratories product could create a situation where personal injury or death may occur. Should Buyer purchase or use Silicon Laboratories products for any such unintended or unauthorized application, Buyer shall indemnify and hold Silicon Laboratories harmless against all claims and damages.

Silicon Laboratories and Silicon Labs are trademarks of Silicon Laboratories Inc. Other products or brandnames mentioned herein are trademarks or registered trademarks of their respective holders.

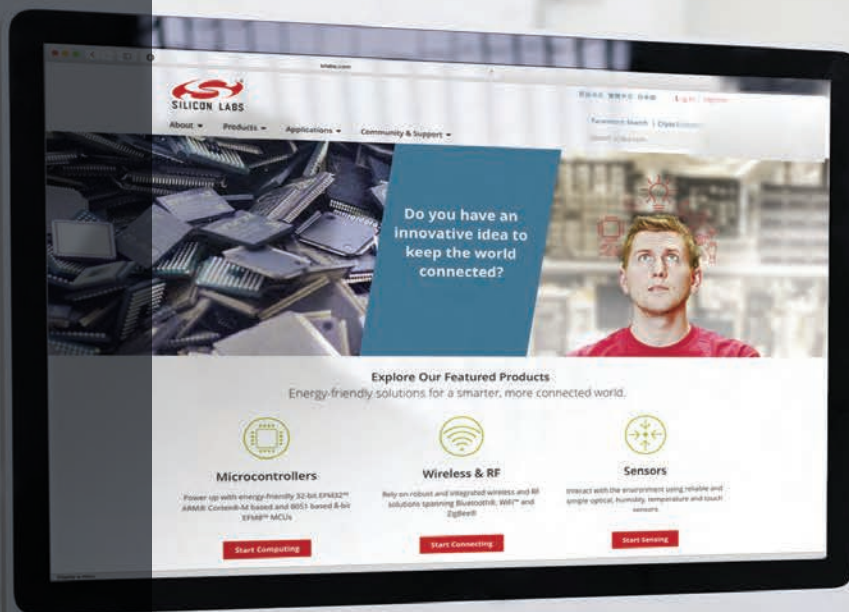

Smart.
Connected.
Energy-Friendly



Products
www.silabs.com/products

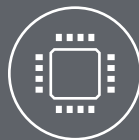

Quality
www.silabs.com/quality



Support and Community
community.silabs.com

Disclaimer

Silicon Laboratories intends to provide customers with the latest, accurate, and in-depth documentation of all peripherals and modules available for system and software implementers using or intending to use the Silicon Laboratories products. Characterization data, available modules and peripherals, memory sizes and memory addresses refer to each specific device, and "Typical" parameters provided can and do vary in different applications. Application examples described herein are for illustrative purposes only. Silicon Laboratories reserves the right to make changes without further notice and limitation to product information, specifications, and descriptions herein, and does not give warranties as to the accuracy or completeness of the included information. Silicon Laboratories shall have no liability for the consequences of use of the information supplied herein. This document does not imply or express copyright licenses granted hereunder to design or fabricate any integrated circuits. The products must not be used within any Life Support System without the specific written consent of Silicon Laboratories. A "Life Support System" is any product or system intended to support or sustain life and/or health, which, if it fails, can be reasonably expected to result in significant personal injury or death. Silicon Laboratories products are generally not intended for military applications. Silicon Laboratories products shall under no circumstances be used in weapons of mass destruction including (but not limited to) nuclear, biological or chemical weapons, or missiles capable of delivering such weapons.

Trademark Information

Silicon Laboratories Inc., Silicon Laboratories, Silicon Labs, SiLabs and the Silicon Labs logo, CMEMS®, EFM, EFM32, EFR, Energy Micro, Energy Micro logo and combinations thereof, "the world's most energy friendly microcontrollers", Ember®, EZLink®, EZMac®, EZRadio®, EZRadioPRO®, DSPLL®, ISOmodem®, Precision32®, ProSLIC®, SiPHY®, USBXpress® and others are trademarks or registered trademarks of Silicon Laboratories Inc. ARM, CORTEX, Cortex-M3 and THUMB are trademarks or registered trademarks of ARM Holdings. Keil is a registered trademark of ARM Limited. All other products or brand names mentioned herein are trademarks of their respective holders.



Silicon Laboratories Inc.
400 West Cesar Chavez
Austin, TX 78701
USA

<http://www.silabs.com>

Looking for pricing, stock, or lifecycle information?

Click below to explore more details on WIN SOURCE:

 [View TS1103-50EG6 on WIN SOURCE](#)

 [Silicon Labs](#) Information

Optimize Your Supply Chain with WIN SOURCE Solutions

-  Global Sourcing Solution
-  Obsolete Management
-  Cost Control Management
-  Shortage Management
-  Alternative Solution
-  Excess Inventory Management