



**THE DATASHEET OF  
TS3480CX33 RFG**



# Low Quiescent Current Low-Dropout Linear Voltage Regulator

## DESCRIPTION

TS3480 series is an integrated linear voltage regulator. It can be provided the operation from an input as high as 30V and a guaranteed maximum dropout of 1.2V at the full 100mA load. The 1.2V quasi low dropout of TS3480 series is able to makes them a nice fit in many applications where the 2 to 2.5V dropout of TS78LXX series devices precludes their use.

The TS3480 series features 5V & 3.3V output voltage options. The SOT packaging and quasi low dropout features of the TS3480 series converge in this device to provide a very nice, very tiny 5V & 3.3V, 100mA bias supply that regulates directly off the system power supply.

## FEATURES

- 30V maximum input for operation
- 2V guaranteed maximum dropout over full load and temperature ranges
- 100mA guaranteed minimum load current
- ±5% guaranteed output voltage tolerance over full load and temperature ranges
- -40 to +125°C junction temperature range for operation
- Compliant to RoHS Directive 2011/65/EU and in accordance to WEEE 2002/96/EC.
- Halogen-free according to IEC 61249-2-21

## APPLICATION

- Tiny alternative to TS78LXX series and similar devices
- Tiny 5V±5% to 3.3V, 100mA converter
- Post regulator for switching DC/DC converter
- Bias supply for analog circuits



### Pin Definition:

1. Output
2. Input
3. Ground

**Notes:** MSL 1 (Moisture Sensitivity Level) per J-STD-020

## TYPICAL APPLICATION CIRCUIT

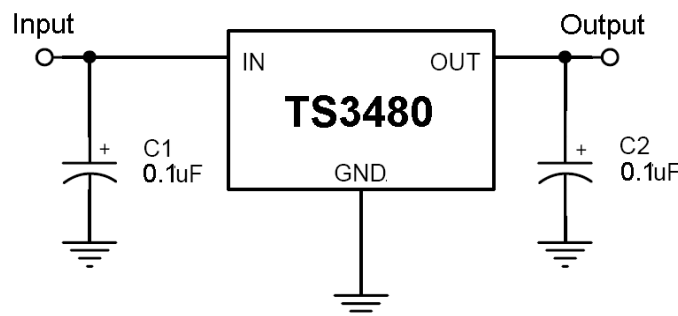

<b>ABSOLUTE MAXIMUM RATINGS</b> ( $T_A = 25^\circ\text{C}$ unless otherwise specified) <sup>(Note 1)</sup>			
PARAMETER	SYMBOL	LIMIT	UNIT
Input Voltage	$V_{IN}$	35	V
Operating Input Voltage	$V_{OPER}$	30	V
Output Current Range	$I_{OUT}$	100	mA
Power Dissipation <sup>(Note 2)</sup>	$P_D$	350	mW
Junction Temperature	$T_J$	+150	$^\circ\text{C}$
Operating Temperature Range	$T_{OPER}$	-40 ~ +125	$^\circ\text{C}$
Storage Temperature Range	$T_{STG}$	-65 ~ +150	$^\circ\text{C}$
Lead Soldering Time (260 $^\circ\text{C}$ ) <sup>(Note 3)</sup>	$T_{SOLDER}$	4	Sec
ESD <sup>(note 4)</sup>		2	kV

<b>ELECTRICAL SPECIFICATIONS</b> ( $T_A = 25^\circ\text{C}$ unless otherwise specified)						
PARAMETER	SYMBOL	CONDITION	MIN	TYP	MAX	UNIT
<b>3.3V Output</b>						
Output Voltage	$V_{OUT}$	$V_{IN} = 4.8\text{V}, I_o = 1\text{mA} \sim 100\text{mA}$	3.17	3.3	3.43	V
Line Regulation	$\Delta V_{DDLine}$	$4.8\text{V} \leq V_{IN} \leq 30\text{V}, I_o = 1\text{mA}$	--	10	25	mV
Load Regulation	$\Delta V_{DDLload}$	$V_{IN} = 4.8\text{V}, I_o = 1\text{mA} \sim 100\text{mA}$	--	20	40	mV
Dropout Voltage	$V_{DROP\_OUT}$	$I_o = 10\text{mA}$	--	0.75	0.9	V
		$I_o = 100\text{mA}$	--	0.95	1.1	V
Quiescent Current		$V_{IN} = 4.8\text{V} \leq V_{IN} \leq 30\text{V}, I_o = 0\text{V}$	--	3	5	mA
Output Current	$I_{OUT}$	$V_{IN} - V_{OUT} = 20\text{V}$	100	--	--	mA
Ripple Rejection		$F = 10\text{Hz} \sim 100\text{kHz}, I_o = 0\text{mA}, C_{OUT} = 0.1\mu\text{F}, V_{IN} = 10\text{V}$	--	100	--	$\mu\text{V}_{RMS}$
<b>5.0V Output</b>						
Output Voltage	$V_{OUT}$	$V_{IN} = 6.5\text{V}, I_o = 1\text{mA} \sim 100\text{mA}$	4.80	5.0	5.20	V
Line Regulation	$\Delta V_{DDLine}$	$6.5\text{V} \leq V_{IN} \leq 30\text{V}, I_o = 1\text{mA}$	--	10	25	mV
Load Regulation	$\Delta V_{DDLload}$	$V_{IN} = 6.5\text{V}, I_o = 10\text{mA} \sim 100\text{mA}$	--	20	40	mV
Dropout Voltage	$V_{DROP\_OUT}$	$I_o = 10\text{mA}$	--	0.75	0.9	V
		$I_o = 100\text{mA}$	--	0.95	1.1	V
Quiescent Current		$V_{IN} = 6.5\text{V} \leq V_{IN} \leq 30\text{V}, I_o = 0\text{V}$	--	3	5	mA
Output Current	$I_{OUT}$	$V_{IN} - V_{OUT} = 20\text{V}$	100	--	--	mA
Ripple Rejection		$F = 10\text{Hz} \sim 100\text{kHz}, I_o = 0\text{mA}, C_{OUT} = 0.1\mu\text{F}, V_{IN} = 10\text{V}$	--	150	--	$\mu\text{V}_{rms}$

**Note:**

1. Absolute Maximum Ratings are limits beyond which damage to the device may occur. Operating ratings are conditions under which operation of the device is guaranteed. Operating ratings do not imply guaranteed performance limits. For guaranteed performance limits and associated test conditions, see the Electrical Characteristics.
2. The Absolute Maximum power dissipation depends on the ambient temperature and can be calculated using  $P = (T_J - T_A) / R_{\theta JA}$  where  $T_J$  is the junction temperature,  $T_A$  is the ambient temperature, and  $R_{\theta JA}$  is the junction-to-ambient thermal resistance. The 350mW rating results from substituting the absolute maximum junction temperature, 150°C for  $T_J$ , 50°C for  $T_A$ , and 300°C/W for  $R_{\theta JA}$ . More power can be safely dissipated at lower ambient temperatures, and less power can be safely dissipated at higher ambient temperatures. The absolute maximum power dissipation can be increased by 3.5mW for each Celsius below 50°C ambient. It must be derated by 3.5mW for each Celsius above 50°C ambient. A  $R_{\theta JA}$  of 300°C/W represents the worst-case condition of no heat sinking of the 3-lead plastic SOT-23 package. Heat sinking enables the safe dissipation of more power. The TS3480 actively limits its junction temperature to about 150°C.
3. Times shown are dwell times. Temperatures shown are dwell temperatures.
4. For testing purposes, ESD was applied using the Human-Body Model, a 100pF capacitor discharged through a 1.5kΩ resistor.
5. A typical is the center of characterization data taken with  $T_A = T_J = 25^\circ\text{C}$ . Typical are not guaranteed.
6. All limits are guaranteed. All electrical characteristics having room-temperature limits are tested during production with  $T_A = T_J = 25^\circ\text{C}$ . All hot and cold limits are guaranteed by correlating the electrical characteristics to process and temperature variations and applying statistical process control.
7. All voltages except dropout are with respect to the voltage at the GND pin.

**ORDERING INFORMATION**

OUTPUT VOLTAGE	ORDERING CODE.	PACKAGE	PACKING
3.3V	TS3480CX33 RFG	SOT-23	3,000pcs / 7" Reel
5V	TS3480CX50 RFG	SOT-23	3,000pcs / 7" Reel

**CHARACTERISTICS CURVES**

( $T_c = 25^\circ\text{C}$  unless otherwise noted)

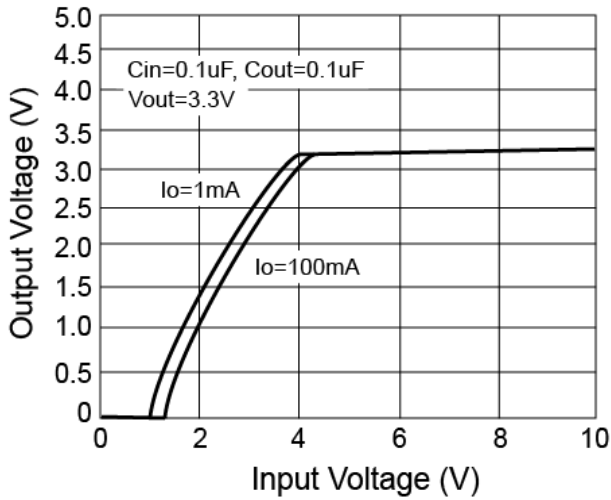

**Figure 1. Output Voltage vs. Input Voltage**

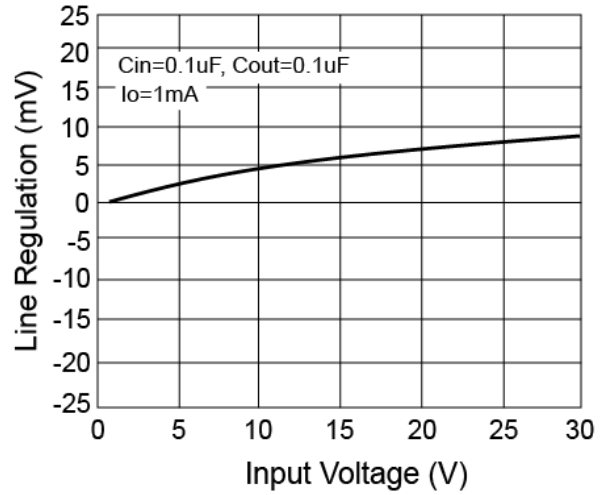

**Figure 2. Line Regulation**

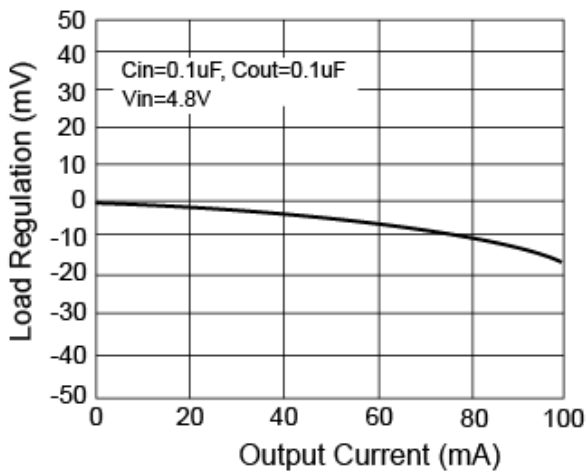

**Figure 3. Load Regulation**

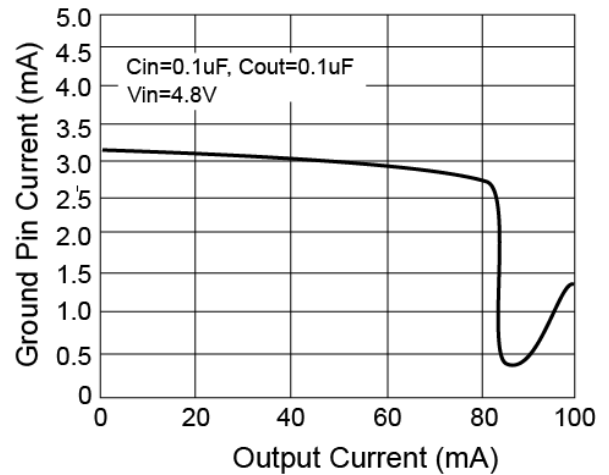

**Figure 4. Ground Pin Current vs. Output Current**

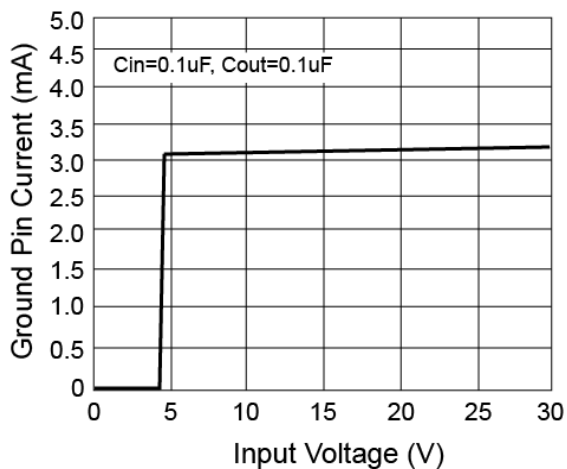

**Figure 5. Ground Pin Current vs. Input Voltage**

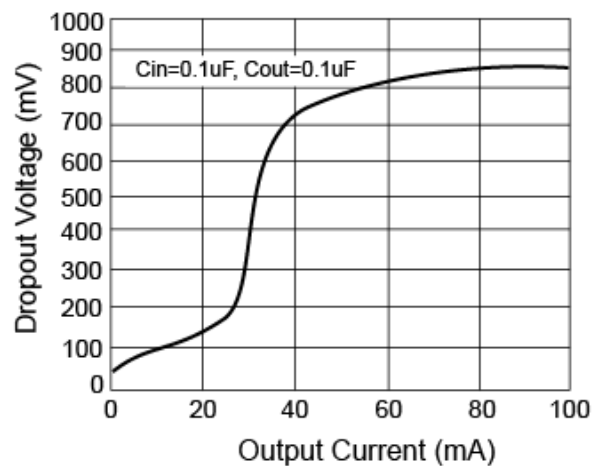

**Figure 6. Dropout Voltage vs. Load Current**

**PACKAGE OUTLINE DIMENSIONS** (Unit: Millimeters)

**SOT-23**

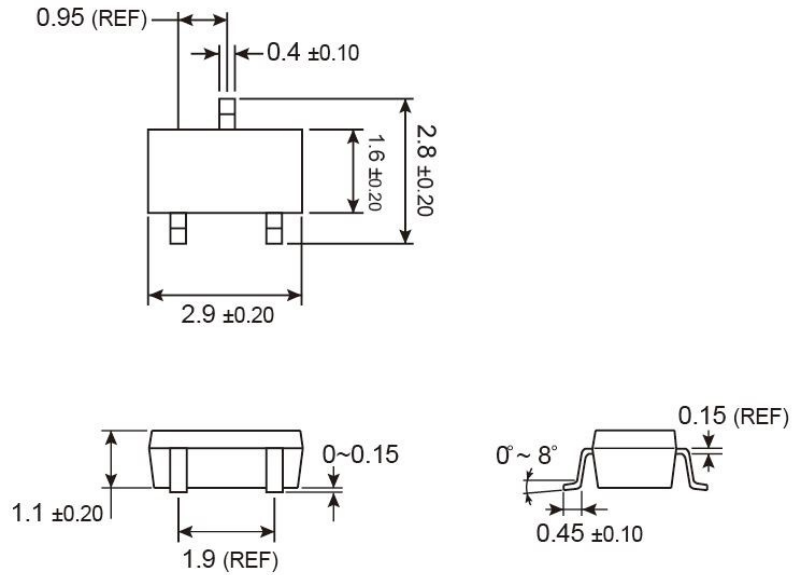

**SUGGESTED PAD LAYOUT** (Unit: Millimeters)

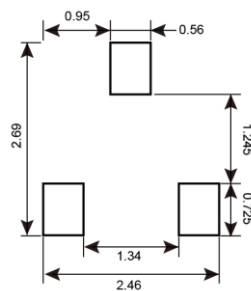

**MARKING DIAGRAM**

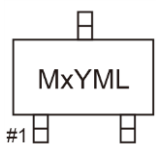

- M** = Device Code
- x** = Voltage Code (5=5V, S=3.3V)
- Y** = Year Code
- M** = Month Code for Halogen Free Product
  - O** =Jan    **P** =Feb    **Q** =Mar    **R** =Apr
  - S** =May    **T** =Jun    **U** =Jul    **V** =Aug
  - W** =Sep    **X** =Oct    **Y** =Nov    **Z** =Dec
- L** = Lot Code (1~9, A~Z)

## Notice



Specifications of the products displayed herein are subject to change without notice. TSC or anyone on its behalf, assumes no responsibility or liability for any errors or inaccuracies.

Information contained herein is intended to provide a product description only. No license, express or implied, to any intellectual property rights is granted by this document. Except as provided in TSC's terms and conditions of sale for such products, TSC assumes no liability whatsoever, and disclaims any express or implied warranty, relating to sale and/or use of TSC products including liability or warranties relating to fitness for a particular purpose, merchantability, or infringement of any patent, copyright, or other intellectual property right.







The products shown herein are not designed for use in medical, life-saving, or life-sustaining applications. Customers using or selling these products for use in such applications do so at their own risk and agree to fully indemnify TSC for any damages resulting from such improper use or sale.

## Looking for pricing, stock, or lifecycle information?

Click below to explore more details on WIN SOURCE:

-  [View TS3480CX33 RFG on WIN SOURCE](#)
-  [Taiwan Semiconductor](#) Information

## Optimize Your Supply Chain with WIN SOURCE Solutions

-  Global Sourcing Solution
-  Obsolete Management
-  Cost Control Management
-  Shortage Management
-  Alternative Solution
-  Excess Inventory Management