



**THE DATASHEET OF
BG3123RE6327HTSA1**



DUAL N-Channel MOSFET Tetrode

- Two gain controlled input stages for UHF and VHF -tuners e.g. (NTSC, PAL)
- Optimized for UHF (amp. B) and VHF (amp. A)
- Integrated gate protection diodes
- High AGC-range, low noise figure, high gain
- Improved cross modulation at gain reduction

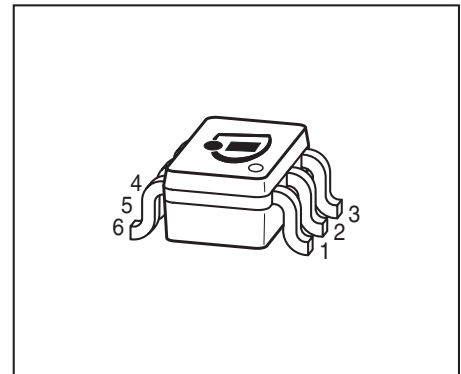
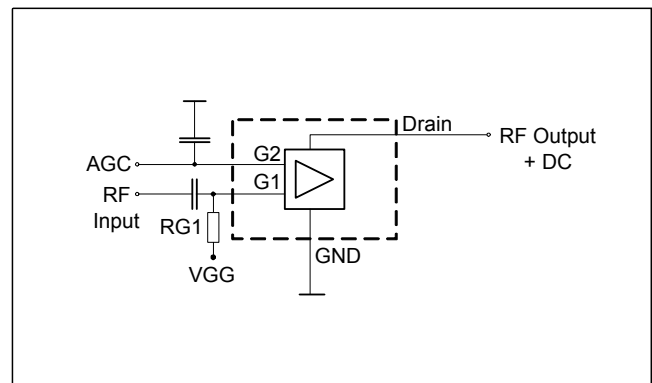
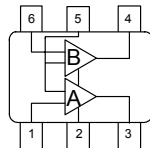
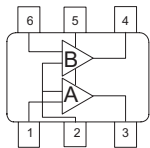
BG3123
BG3123R

ESD (Electrostatic discharge) sensitive device, observe handling precaution!

Type	Package	Pin Configuration						Marking
BG3123	SOT363	1=G1*	2=G2	3=D*	4=D**	5=S	6=G1**	KOs
BG3123R	SOT363	1=G1*	2=S	3=D*	4=D**	5=G2	6=G1**	KRs

* For amp. A; ** for amp. B

180° rotated tape loading orientation available

Maximum Ratings

Parameter	Symbol	Value	Unit
Drain-source voltage	V_{DS}	8	V
Continuous drain current	I_D		mA
amp. A		25	
amp. B		20	
Gate 1/ gate 2-source current	$\pm I_{G1/2SM}$	1	
Gate 1/ gate 2-source voltage	$\pm V_{G1/G2S}$	6	V
Total power dissipation	P_{tot}	200	mW
Storage temperature	T_{stg}	-55 ... 150	°C
Channel temperature	T_{ch}	150	

Thermal Resistance

Parameter	Symbol	Value	Unit
Channel - soldering point ¹⁾	R_{thchs}	≤ 150	K/W

Electrical Characteristics at $T_A = 25^\circ\text{C}$, unless otherwise specified

Parameter	Symbol	Values			Unit
		min.	typ.	max.	

DC Characteristics

Drain-source breakdown voltage $I_D = 10 \mu\text{A}$, $V_{G1S} = 0 \text{ V}$, $V_{G2S} = 0 \text{ V}$	$V_{(BR)DS}$	12	-	-	V
Gate1-source breakdown voltage $+I_{G1S} = 10 \text{ mA}$, $V_{G2S} = 0 \text{ V}$, $V_{DS} = 0 \text{ V}$	$+V_{(BR)G1SS}$	6	-	15	
Gate2-source breakdown voltage $+I_{G2S} = 10 \text{ mA}$, $V_{G1S} = 0 \text{ V}$, $V_{DS} = 0 \text{ V}$	$+V_{(BR)G2SS}$	6	-	15	
Gate1-source leakage current $V_{G1S} = 6 \text{ V}$, $V_{G2S} = 0 \text{ V}$	$+I_{G1SS}$	-	-	50	μA
Gate2-source leakage current $V_{G2S} = 8 \text{ V}$, $V_{G1S} = 0 \text{ V}$, $V_{DS} = 0 \text{ V}$	$+I_{G2SS}$	-	-	50	nA
Drain current $V_{DS} = 5 \text{ V}$, $V_{G1S} = 0 \text{ V}$, $V_{G2S} = 4.5 \text{ V}$	I_{DSS}	-	-	10	μA
Drain-source current $V_{DS} = 5 \text{ V}$, $V_{G2S} = 4 \text{ V}$, $R_{G1} = 60 \text{ k}\Omega$, amp. A $V_{DS} = 5 \text{ V}$, $V_{G2S} = 4 \text{ V}$, $R_{G1} = 50 \text{ k}\Omega$, amp. B	I_{DSX}	-	14	-	mA
Gate1-source pinch-off voltage $V_{DS} = 5 \text{ V}$, $V_{G2S} = 4 \text{ V}$, $I_D = 20 \mu\text{A}$	$V_{G1S(p)}$	-	0.7	-	V
Gate2-source pinch-off voltage $V_{DS} = 5 \text{ V}$, $I_D = 20 \mu\text{A}$	$V_{G2S(p)}$	-	0.6	-	

¹⁾For calculation of R_{thJA} please refer to Application Note Thermal Resistance

Electrical Characteristics at $T_A = 25^\circ\text{C}$, unless otherwise specified

Parameter	Symbol	Values			Unit
		min.	typ.	max.	
AC Characteristics $V_{DS} = 5\text{V}$, $V_{G2S} = 4\text{V}$, ($I_D = 14\text{ mA}$) (verified by random sampling)					
Forward transconductance amp. A amp. B	g_{fs}	- - -	30 25	- -	mS
Gate1 input capacitance $f = 10\text{ MHz}$, amp. A $f = 10\text{ MHz}$, amp. B	C_{g1ss}	- -	1.9 1.5	- -	pF
Output capacitance $f = 10\text{ MHz}$, amp. A $f = 10\text{ MHz}$, amp. B	C_{dss}	- -	1.3 1.1	- -	
Power gain $f = 800\text{ MHz}$, amp. A $f = 800\text{ MHz}$, amp. B $f = 45\text{ MHz}$, amp. A $f = 45\text{ MHz}$, amp. B	G_p	- - - -	25 24 32 30	- - - -	dB
Noise figure $f = 800\text{ MHz}$, amp. A $f = 800\text{ MHz}$, amp. B $f = 45\text{ MHz}$, amp. A $f = 45\text{ MHz}$, amp. B	F	- - - -	1.8 1.8 1.4 1.6	- - - -	dB
Gain control range $V_{G2S} = 4 \dots 0\text{ V}$, $f = 800\text{ MHz}$	ΔG_p	45	-	-	
Cross-modulation $k=1\%$, $f_w=50\text{MHz}$, $f_{unw}=60\text{MHz}$ amp.A , AGC = 0 dB amp. B, AGC = 0 dB amp. A , AGC = 10 dB amp. B , AGC = 10 dB amp. A, AGC = 40 dB amp. B, AGC = 40 dB	X_{mod}	90 90 - - 98 98	96 97 91 94 103 104	- - - - - -	-

Total power dissipation $P_{tot} = f(T_S)$

amp. A

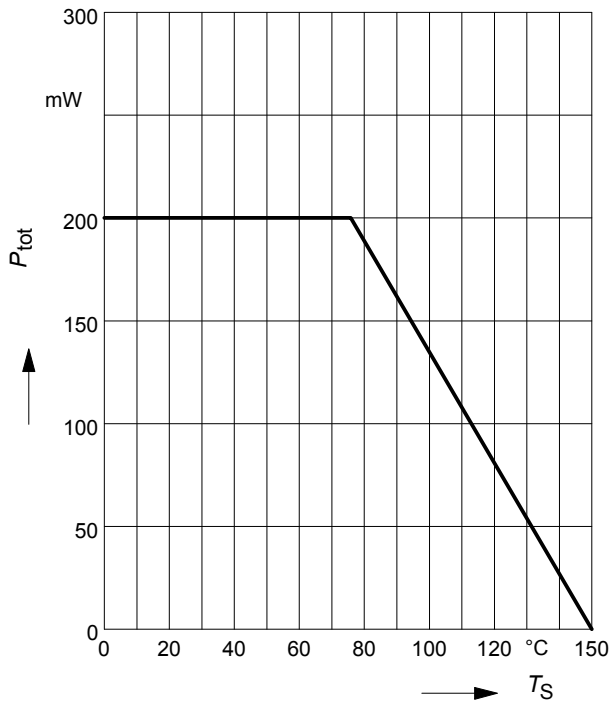

Total power dissipation $P_{tot} = f(T_S)$

amp. B

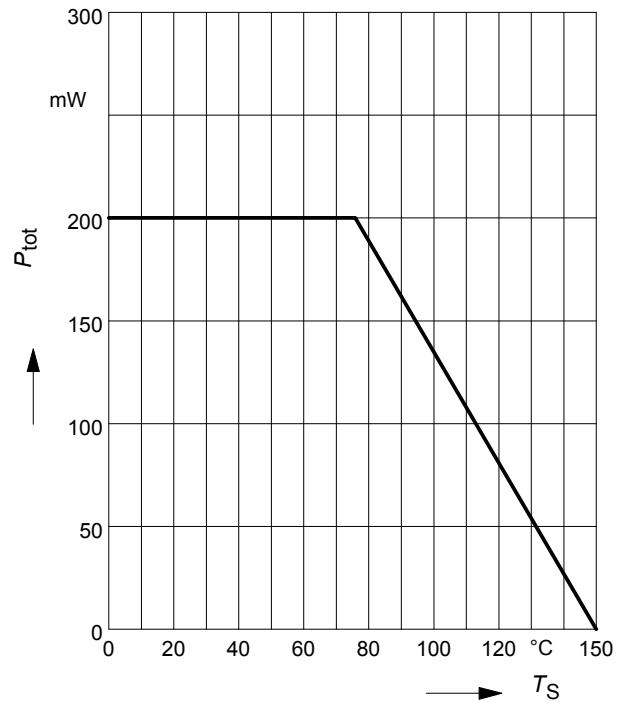

Drain current $I_D = f(I_{G1})$

$V_{G2S} = 4V$

amp. A

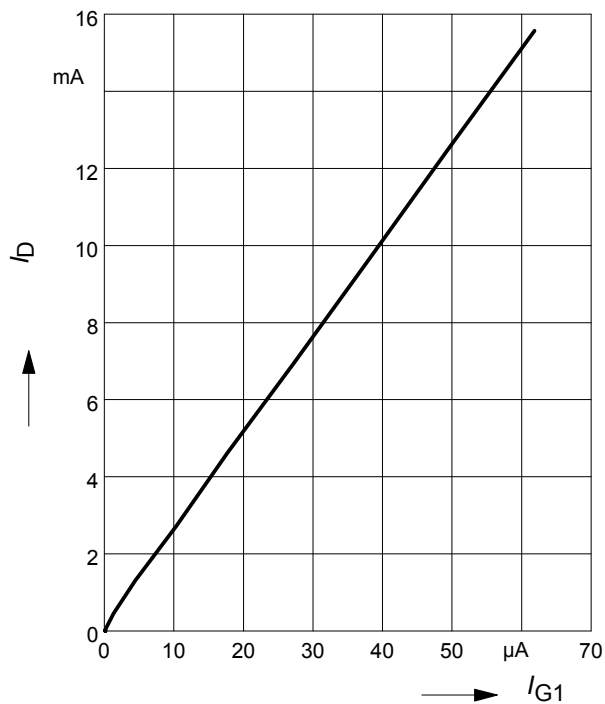

Drain current $I_D = f(I_{G1})$

$V_{G2S} = 4V$

amp. B

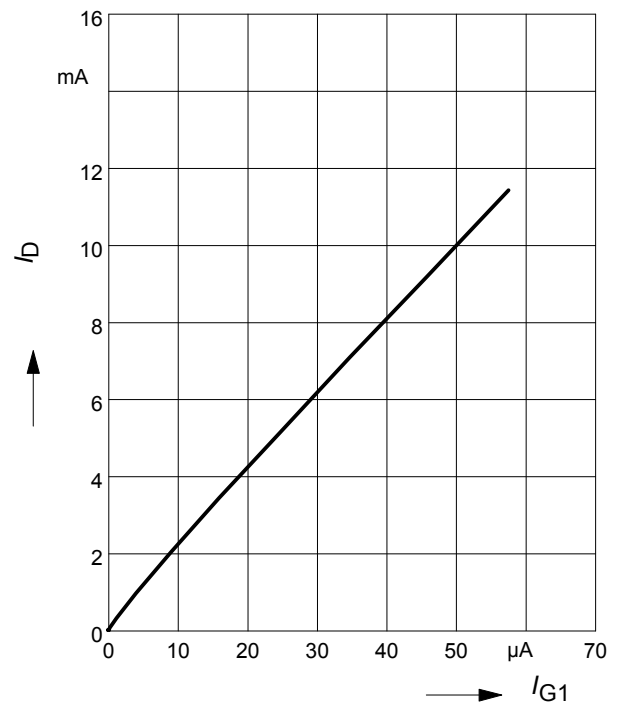

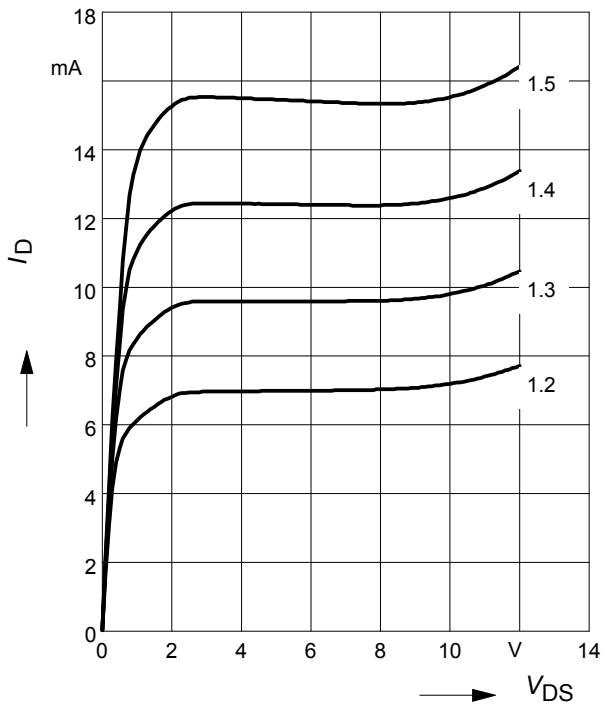
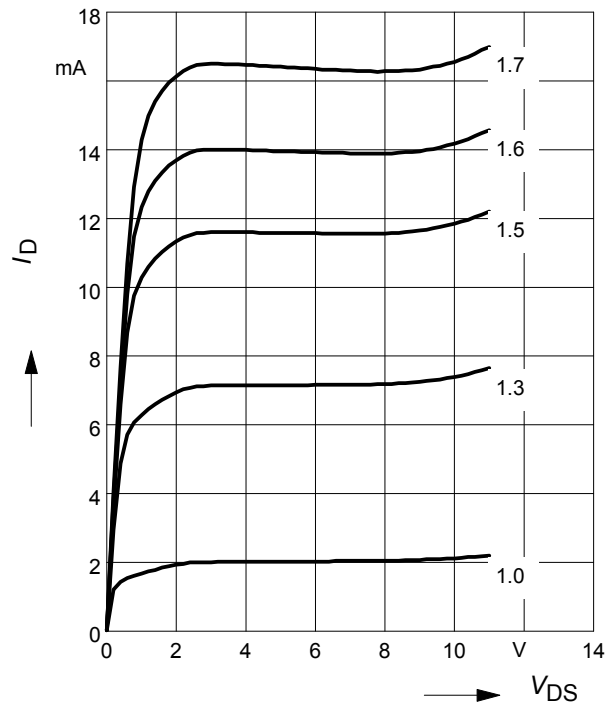
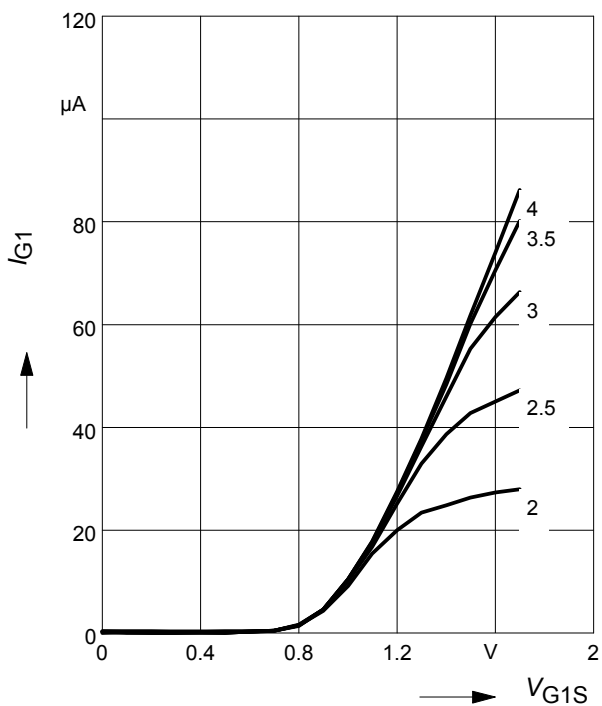
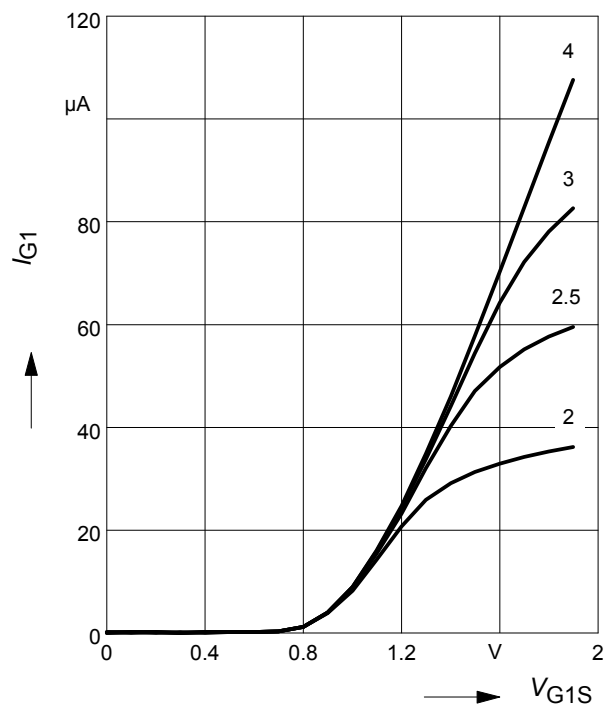
Output characteristics $I_D = f(V_{DS})$
 $V_{G2S} = 4V$, $V_{G1S} =$ Parameter in V
 amp. A

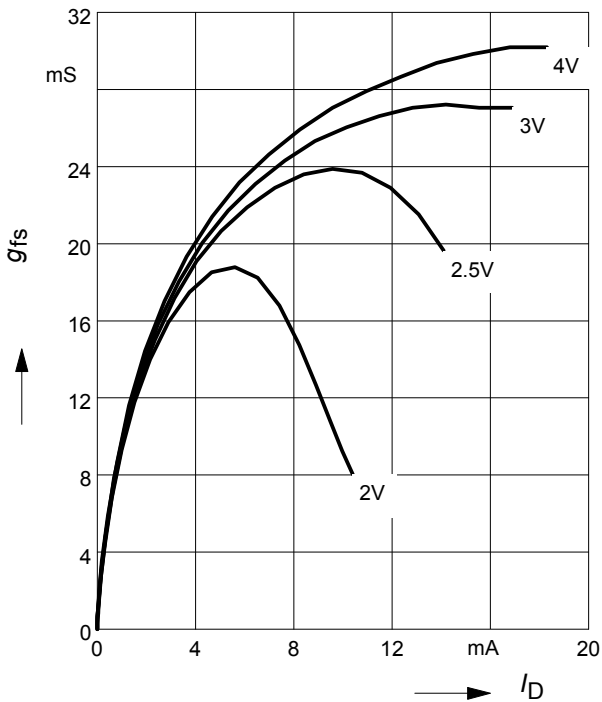
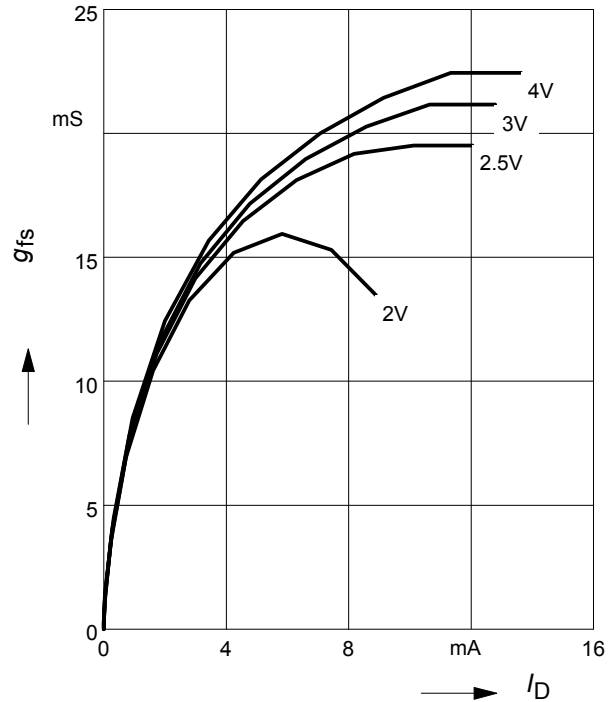
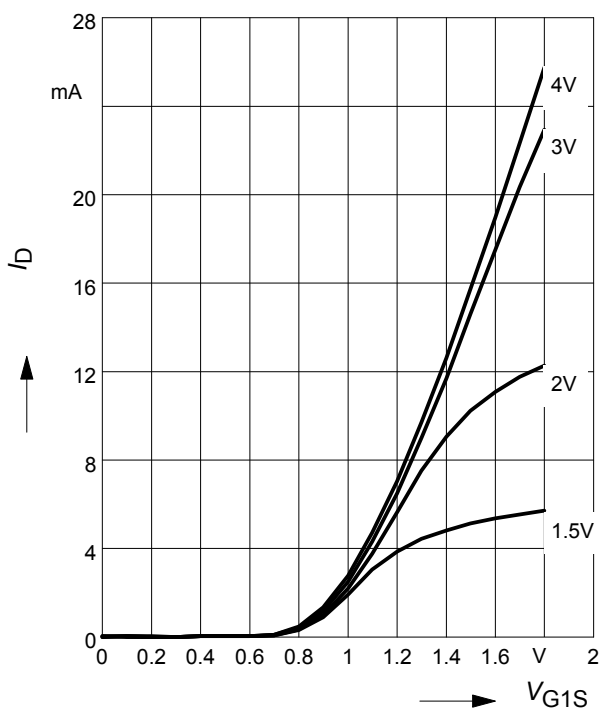
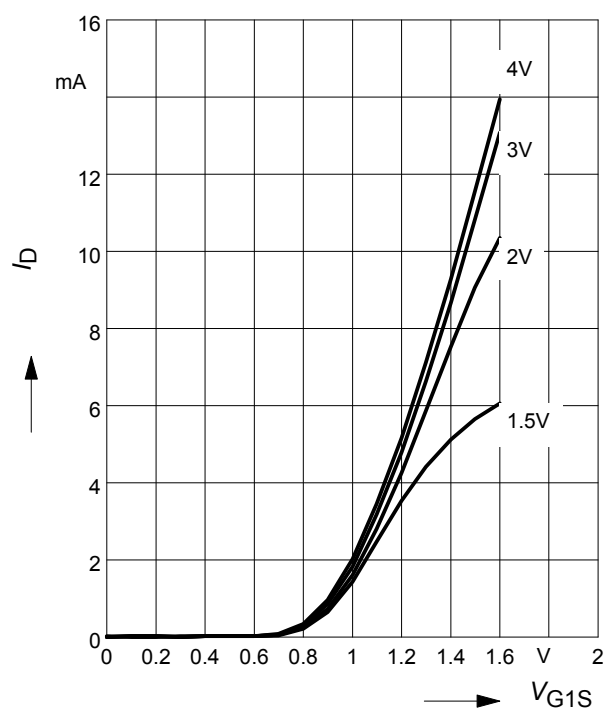
Output characteristics $I_D = f(V_{DS})$
 $V_{G2S} = 4V$, $V_{G1S} =$ Parameter in V
 amp. B

Gate 1 current $I_{G1} = f(V_{G1S})$
 $V_{DS} = 5V$, $V_{G2S} =$ Parameter in V
 amp. A

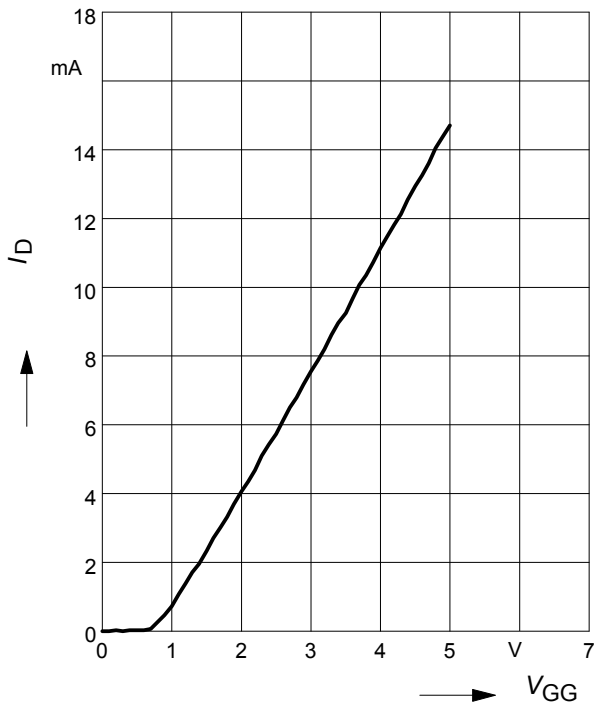
Gate 1 current $I_{G1} = f(V_{G1S})$
 $V_{DS} = 5V$, $V_{G2S} =$ Parameter in V
 amp. B

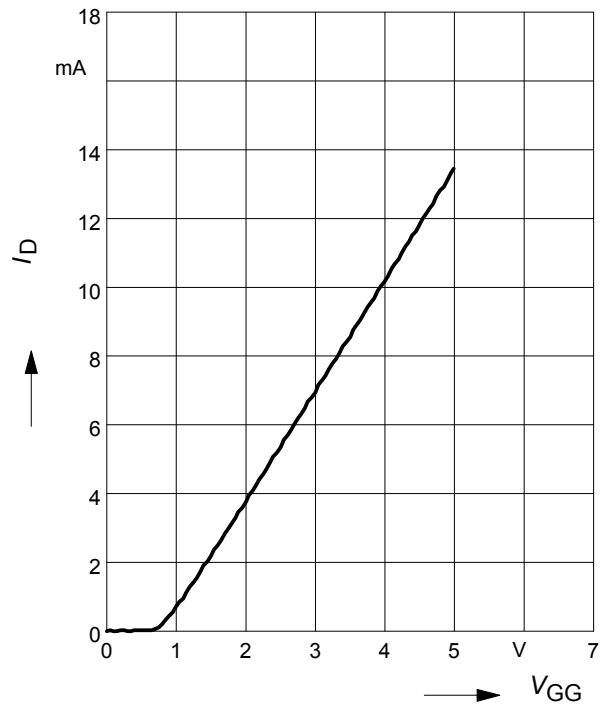
Gate 1 forward transconductance
 $g_{fs} = f(I_D)$, $V_{DS} = 5V$, $V_{G2S} = \text{Parameter}$
 amp. A

Gate 1 forward transconductance
 $g_{fs} = f(I_D)$, $V_{DS} = 5V$, $V_{G2S} = \text{Parameter}$
 amp. B

Drain current $I_D = f(V_{G1S})$
 $V_{DS} = 5V$, $V_{G2S} = \text{Parameter}$
 amp. A

Drain current $I_D = f(V_{G1S})$
 $V_{DS} = 5V$, $V_{G2S} = \text{Parameter}$
 amp. B

Drain current $I_D = f(V_{GG})$ amp. A
 $V_{DS} = 5V, V_{G2S} = 4V, R_{G1} = 60k\Omega$

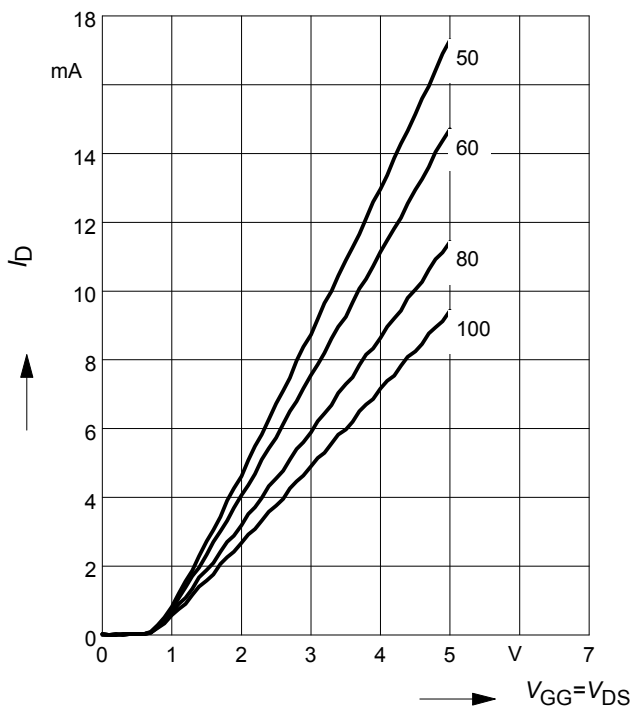
 (connected to V_{GG} , $V_{GG} = \text{gate1 supply voltage}$)

Drain current $I_D = f(V_{GG})$ amp. B
 $V_{DS} = 5V, V_{G2S} = 4V, R_{G1} = 50k\Omega$

 (connected to V_{GG} , $V_{GG} = \text{gate1 supply voltage}$)

Drain current $I_D = f(V_{GG})$
 $V_{G2S} = 4V, R_{G1} = \text{Parameter in } k\Omega$

amp. A

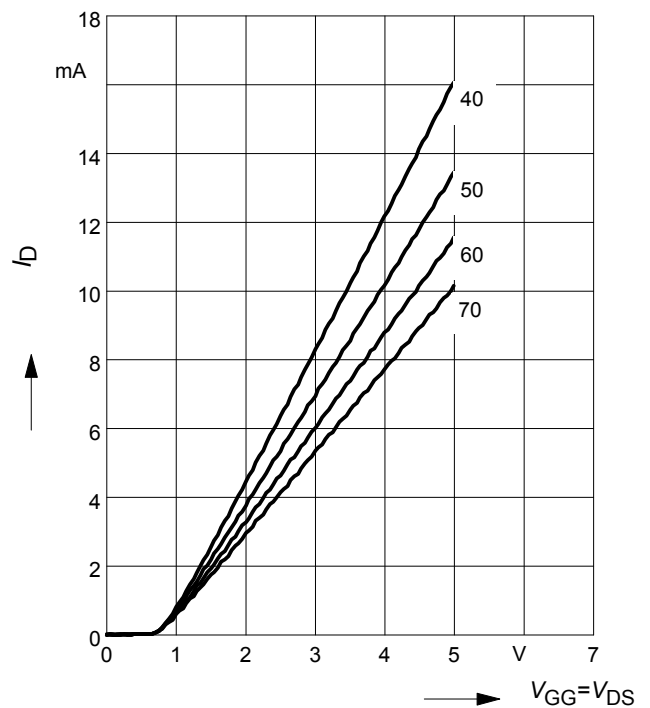
Drain current $I_D = f(V_{GG})$
 $V_{G2S} = 4V, R_{G1} = \text{Parameter in } k\Omega$

amp. B



Crossmodulation $V_{unw} = (AGC)$

$V_{DS} = 5\text{ V}$, $R_{g1} = 68\text{ k}\Omega$

amp.A

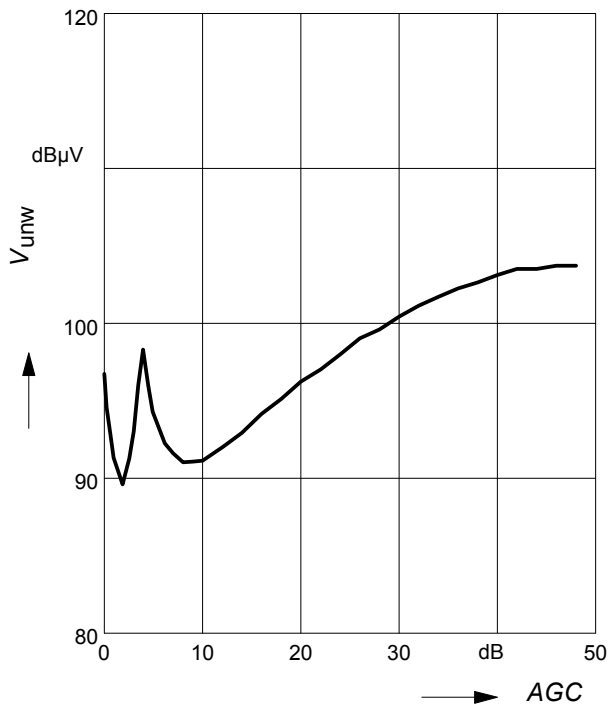

Crossmodulation $V_{unw} = (AGC)$

$V_{DS} = 5\text{ V}$, $R_{g1} = 56\text{ k}\Omega$

amp.B

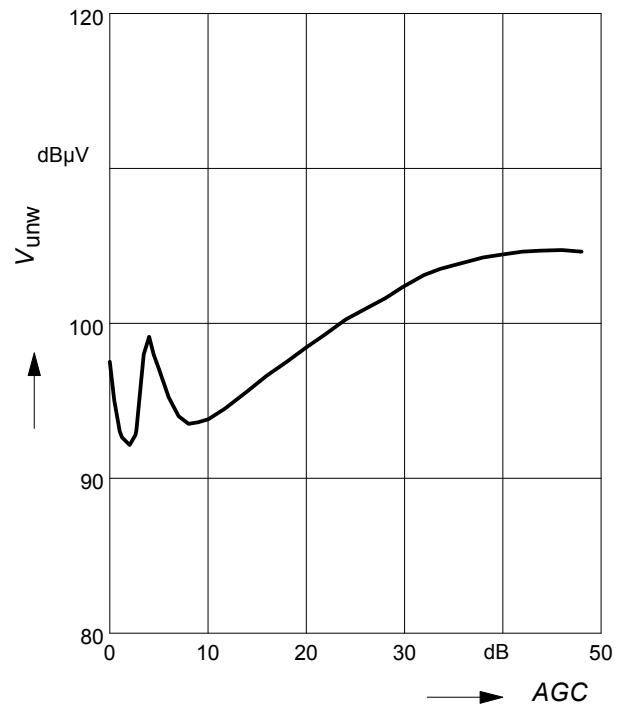

Crossmodulation test circuit

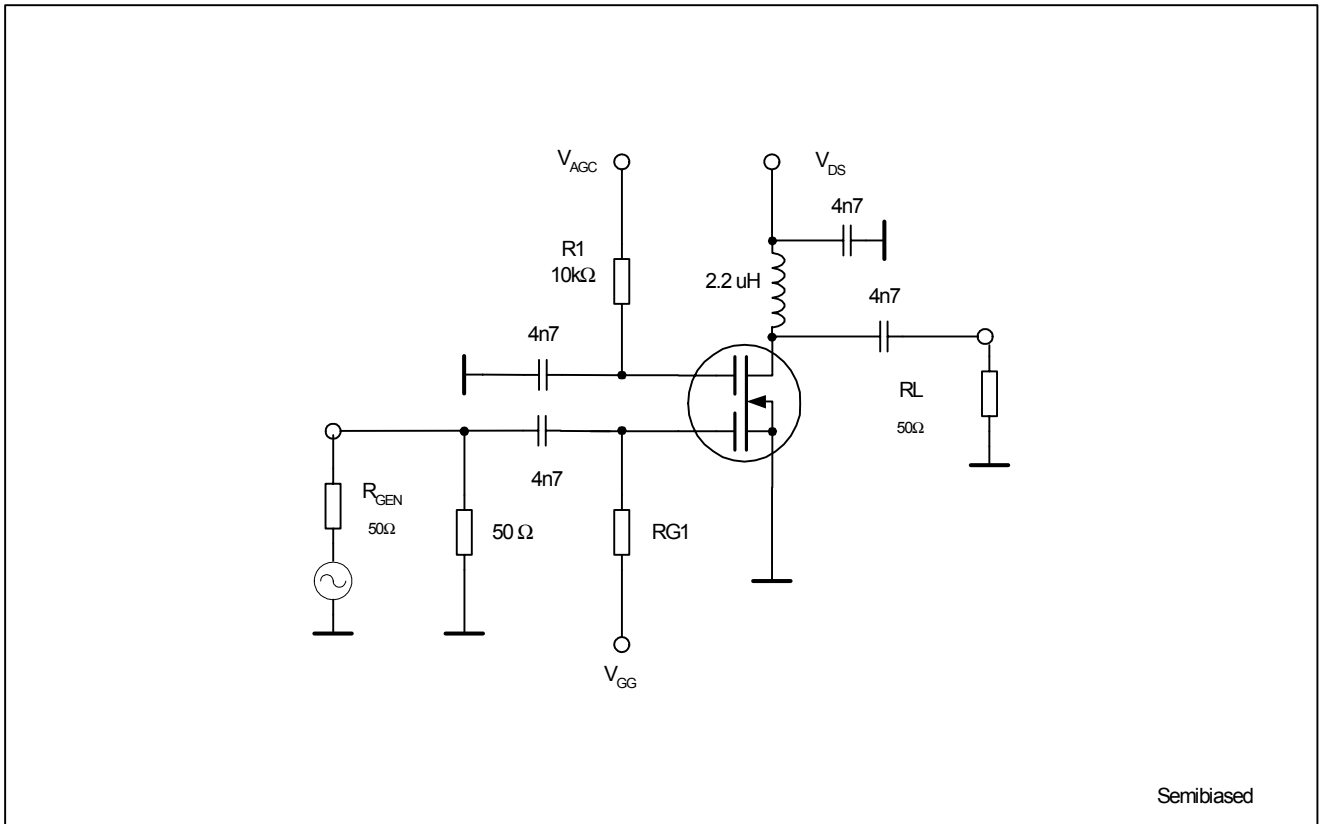

Package Outline

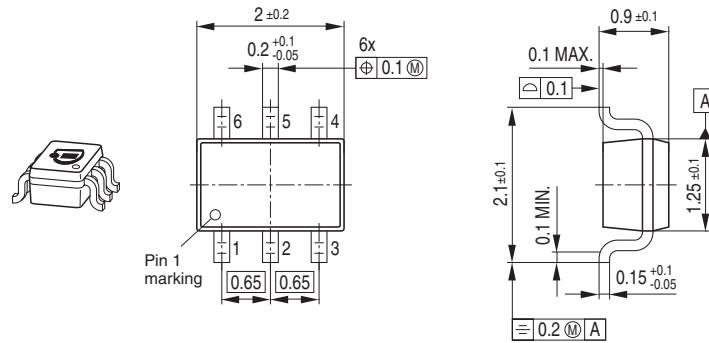

Foot Print

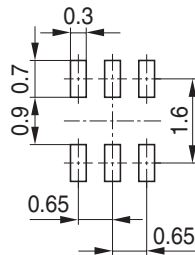

Marking Layout (Example)

Small variations in positioning of Date code, Type code and Manufacture are possible.

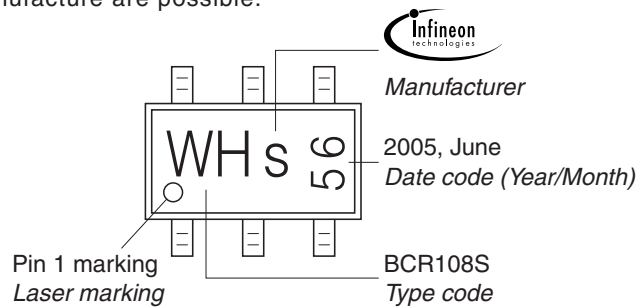

Standard Packing

Reel \varnothing 180 mm = 3.000 Pieces/Reel
 Reel \varnothing 330 mm = 10.000 Pieces/Reel

For symmetric types no defined Pin 1 orientation in reel.

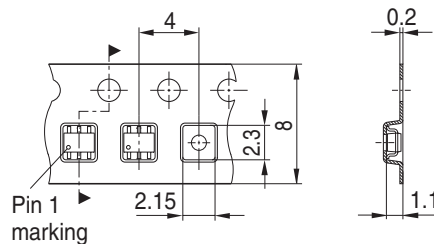

Edition 2006-02-01
Published by
Infineon Technologies AG
81726 München, Germany
© Infineon Technologies AG 2006.
All Rights Reserved.

Attention please!

The information given in this dokument shall in no event be regarded as a guarantee of conditions or characteristics ("Beschaffenheitsgarantie"). With respect to any examples or hints given herein, any typical values stated herein and/or any information regarding the application of the device, Infineon Technologies hereby disclaims any and all warranties and liabilities of any kind, including without limitation warranties of non-infringement of intellectual property rights of any third party.

Information

For further information on technology, delivery terms and conditions and prices please contact your nearest Infineon Technologies Office (www.infineon.com).

Warnings



Due to technical requirements components may contain dangerous substances. For information on the types in question please contact your nearest Infineon Technologies Office.

Infineon Technologies Components may only be used in life-support devices or systems with the express written approval of Infineon Technologies, if a failure of such components can reasonably be expected to cause the failure of that life-support device or system, or to affect the safety or effectiveness of that device or system.

Life support devices or systems are intended to be implanted in the human body, or to support and/or maintain and sustain and/or protect human life. If they fail, it is reasonable to assume that the health of the user or other persons may be endangered.

Looking for pricing, stock, or lifecycle information?

Click below to explore more details on WIN SOURCE:

-  [View BG3123RE6327HTSA1 on WIN SOURCE](#)
-  [Infineon Technologies Information](#)

Optimize Your Supply Chain with WIN SOURCE Solutions

-  Global Sourcing Solution
-  Obsolete Management
-  Cost Control Management
-  Shortage Management
-  Alternative Solution
-  Excess Inventory Management