



**THE DATASHEET OF
BG3230 E6327**



DUAL N-Channel MOSFET Tetrode

- Low noise gain controlled input stages of UHF- and VHF-tuners with 5V supply voltage
- Two AGC amplifiers in one single package
- Integrated stabilized bias network
- Integrated gate protection diodes
- High gain, low noise figure
- Improved cross modulation at gain reduction
- High AGC-range

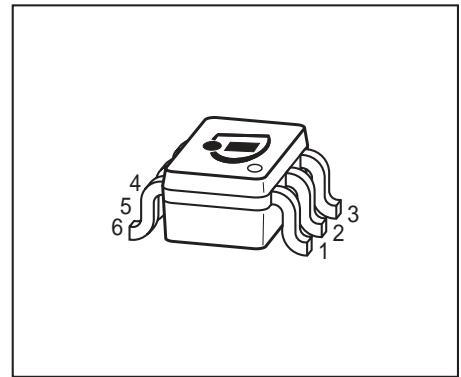
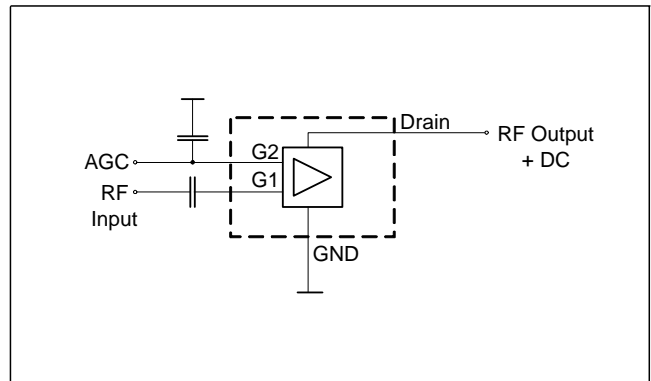
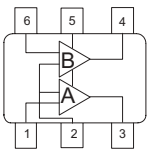
**BG3230
BG3230R**

ESD (Electrostatic discharge) sensitive device, observe handling precaution!

Type	Package	Pin Configuration						Marking
BG3230	SOT363	1=G1*	2=G2	3=D*	4=D**	5=S	6=G1**	KBs
BG3230R	SOT363	1=G1*	2=S	3=D*	4=D**	5=G2	6=G1**	KIs

* For amp. A; ** for amp. B

180° rotated tape loading orientation available

Maximum Ratings

Parameter	Symbol	Value	Unit
Drain-source voltage	V_{DS}	8	V
Continuous drain current	I_D	25	mA
Gate 1/ gate 2-source current	$\pm I_{G1/2SM}$	1	
Gate 1/ gate 2-source voltage	$\pm V_{G1/G2S}$	6	V
Total power dissipation	P_{tot}	200	mW
Storage temperature	T_{stg}	-55 ... 150	°C
Channel temperature	T_{ch}	150	

Thermal Resistance

Parameter	Symbol	Value	Unit
Channel - soldering point ¹⁾	R_{thchs}	≤ 280	K/W

Electrical Characteristics

Parameter	Symbol	Values			Unit
		min.	typ.	max.	

DC Characteristics

Drain-source breakdown voltage $I_D = 100 \mu A, V_{G1S} = 0, V_{G2S} = 0$	$V_{(BR)DS}$	12	-	-	V
Gate1-source breakdown voltage $+I_{G1S} = 10 mA, V_{G2S} = 0, V_{DS} = 0$	$+V_{(BR)G1SS}$	6	-	15	
Gate2 source breakdown voltage $\pm I_{G2S} = 10 mA, V_{G1S} = 0, V_{DS} = 0$	$\pm V_{(BR)G2SS}$	6	-	15	
Gate1-source leakage current $V_{G1S} = 6 V, V_{G2S} = 0$	$+I_{G1SS}$	-	-	50	μA
Gate 2 source leakage current $\pm V_{G2S} = 6 V, V_{G1S} = 0, V_{DS} = 0$	$\pm I_{G2SS}$	-	-	50	nA
Drain current $V_{DS} = 5 V, V_{G1S} = 0, V_{G2S} = 4 V$	I_{DSS}	-	-	100	μA
Operating current (selfbiased) $V_{DS} = 5 V, V_{G2S} = 4 V$	I_{DSO}	-	13	-	mA
Gate2-source pinch-off voltage $V_{DS} = 5 V, I_D = 100 \mu A$	$V_{G2S(p)}$	-	1	-	V

¹⁾For calculation of R_{thJA} please refer to Application Note Thermal Resistance

Electrical Characteristics

Parameter	Symbol	Values			Unit
		min.	typ.	max.	
AC Characteristics - (verified by random sampling)					
Forward transconductance $V_{DS} = 5\text{ V}$, $V_{G2S} = 4\text{ V}$	g_{fs}	-	33	-	mS
Gate1 input capacitance $V_{DS} = 5\text{ V}$, $V_{G2S} = 4\text{ V}$, $f = 10\text{ MHz}$	C_{g1ss}	-	1.9	-	pF
Output capacitance $V_{DS} = 5\text{ V}$, $V_{G2S} = 4\text{ V}$, $f = 10\text{ MHz}$	C_{dss}	-	1.1	-	
Power gain (self biased) $V_{DS} = 5\text{ V}$, $V_{G2S} = 4\text{ V}$, $f = 800\text{ MHz}$ $V_{DS} = 5\text{ V}$, $V_{G2S} = 4\text{ V}$, $f = 45\text{ MHz}$	G_p	-	24	-	dB
		-	31	-	
Noise figure (self biased) $V_{DS} = 5\text{ V}$, $V_{G2S} = 4\text{ V}$, $f = 800\text{ MHz}$ $V_{DS} = 5\text{ V}$, $V_{G2S} = 4\text{ V}$, $f = 45\text{ MHz}$	F	-	1.3	-	dB
		-	1.7	-	
Gain control range $V_{DS} = 5\text{ V}$, $V_{G2S} = 4\dots 0\text{ V}$, $f = 800\text{ MHz}$	ΔG_p	45	-	-	
Cross-modulation $k=1\%$, $f_w=50\text{MHz}$, $f_{unw}=60\text{MHz}$ AGC = 0 dB AGC = 10 dB AGC = 40 dB	X_{mod}	90	-	-	-
		-	87	-	
		96	100	-	

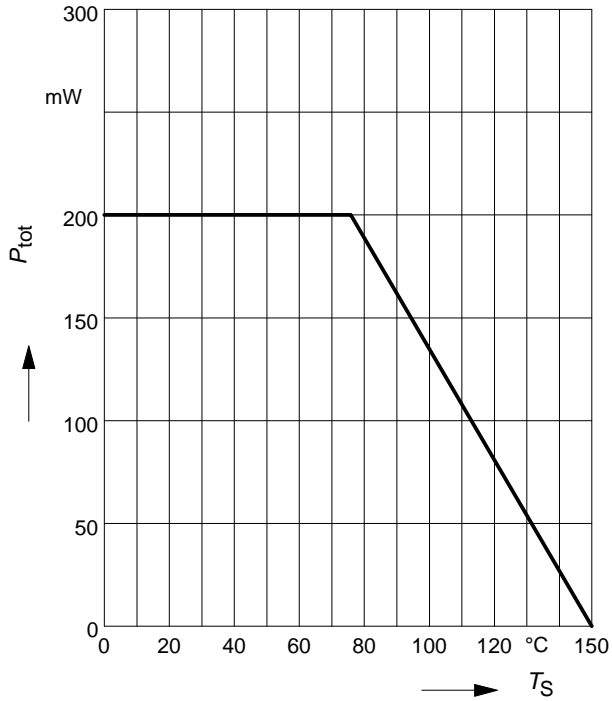
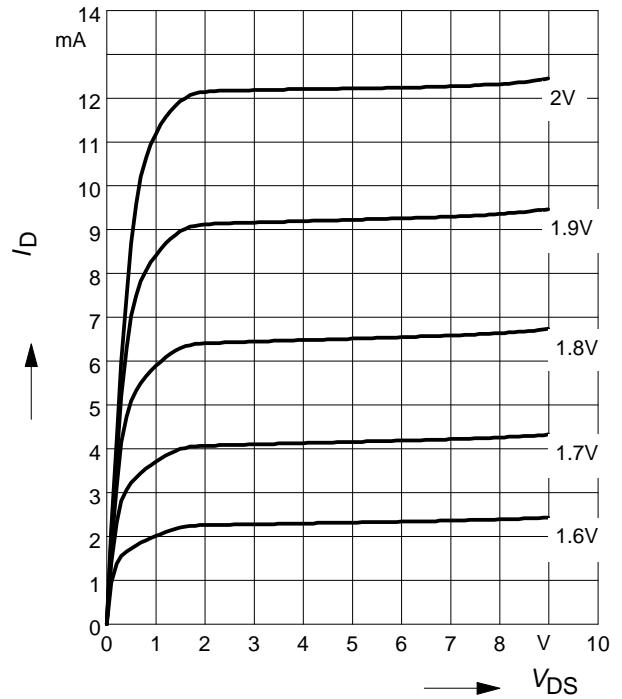
Total power dissipation $P_{\text{tot}} = f(T_S)$

Output characteristics $I_D = f(V_{\text{DS}})$

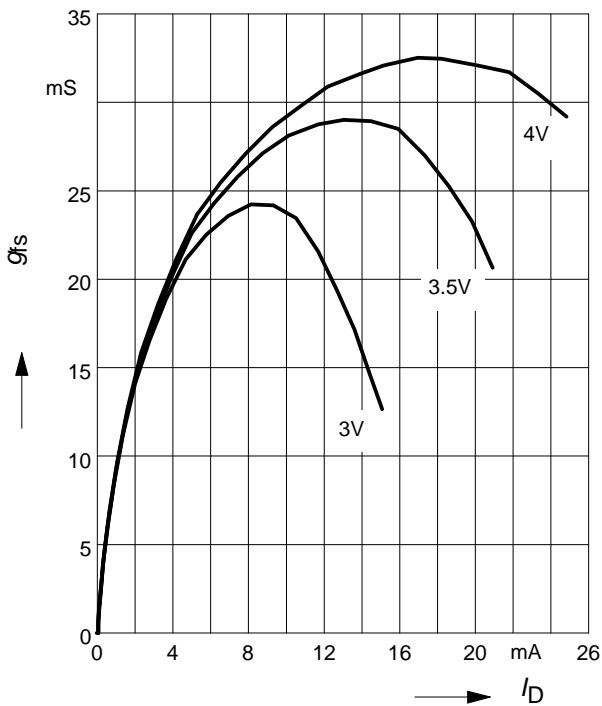
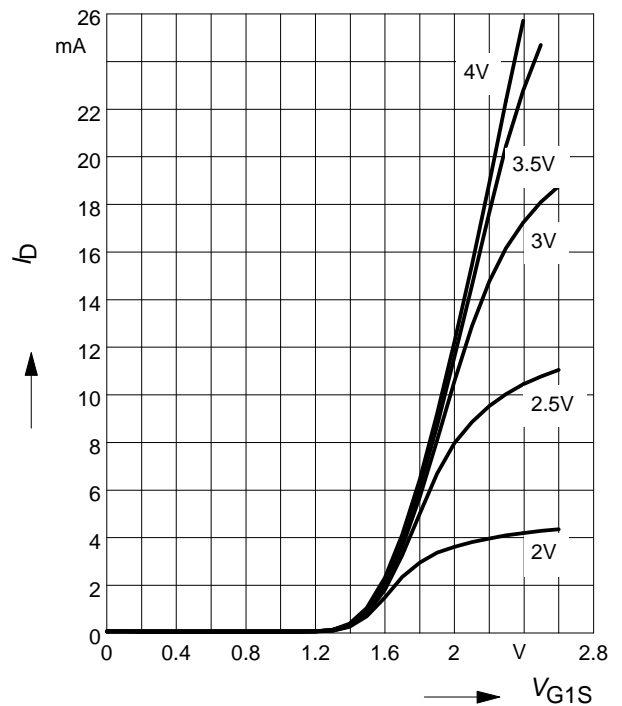
Gate 1 forward transconductance

$$g_{\text{fs}} = f(I_D)$$

 $V_{\text{DS}} = 5\text{V}, V_{\text{G2S}} = \text{Parameter}$

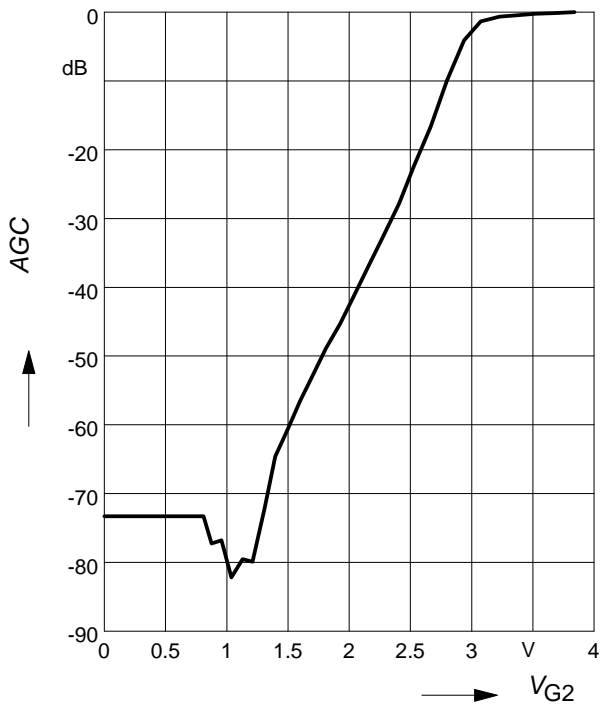
Drain current $I_D = f(V_{\text{G1S}})$
 $V_{\text{DS}} = 5\text{V}$
 $V_{\text{G2S}} = \text{Parameter}$

AGC characteristic $AGC = f(V_{G2S})$

$f = 200 \text{ MHz}$



AGC characteristic $AGC = f(V_{G2S})$

$f = 800 \text{ MHz}$

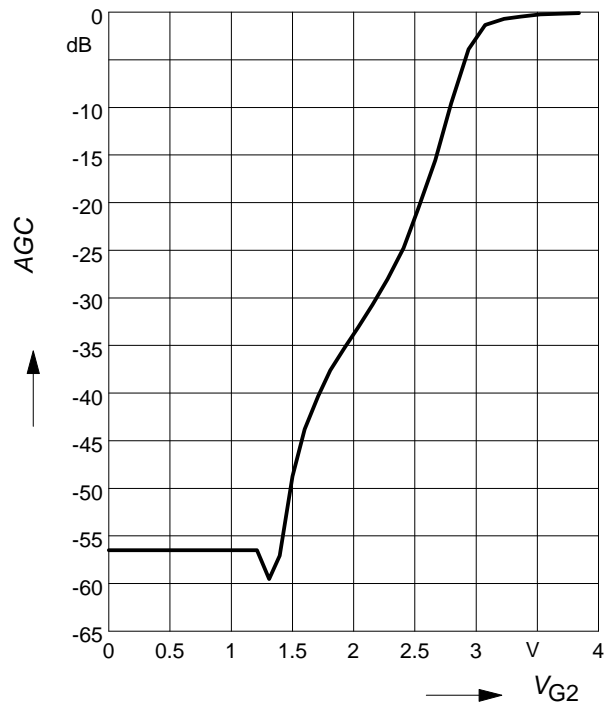

Crossmodulation $V_{unw} = (AGC)$

$V_{DS} = 5 \text{ V}, R_{g1} = 68 \text{ k}\Omega$

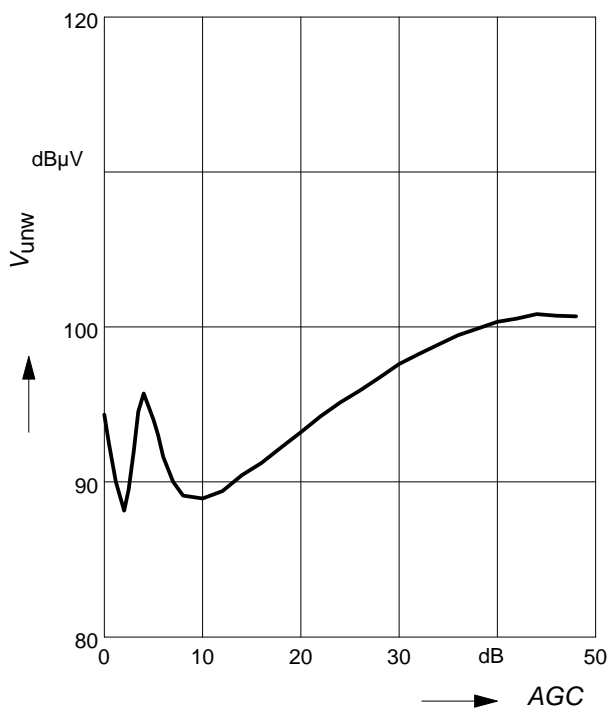

Crossmodulation test circuit

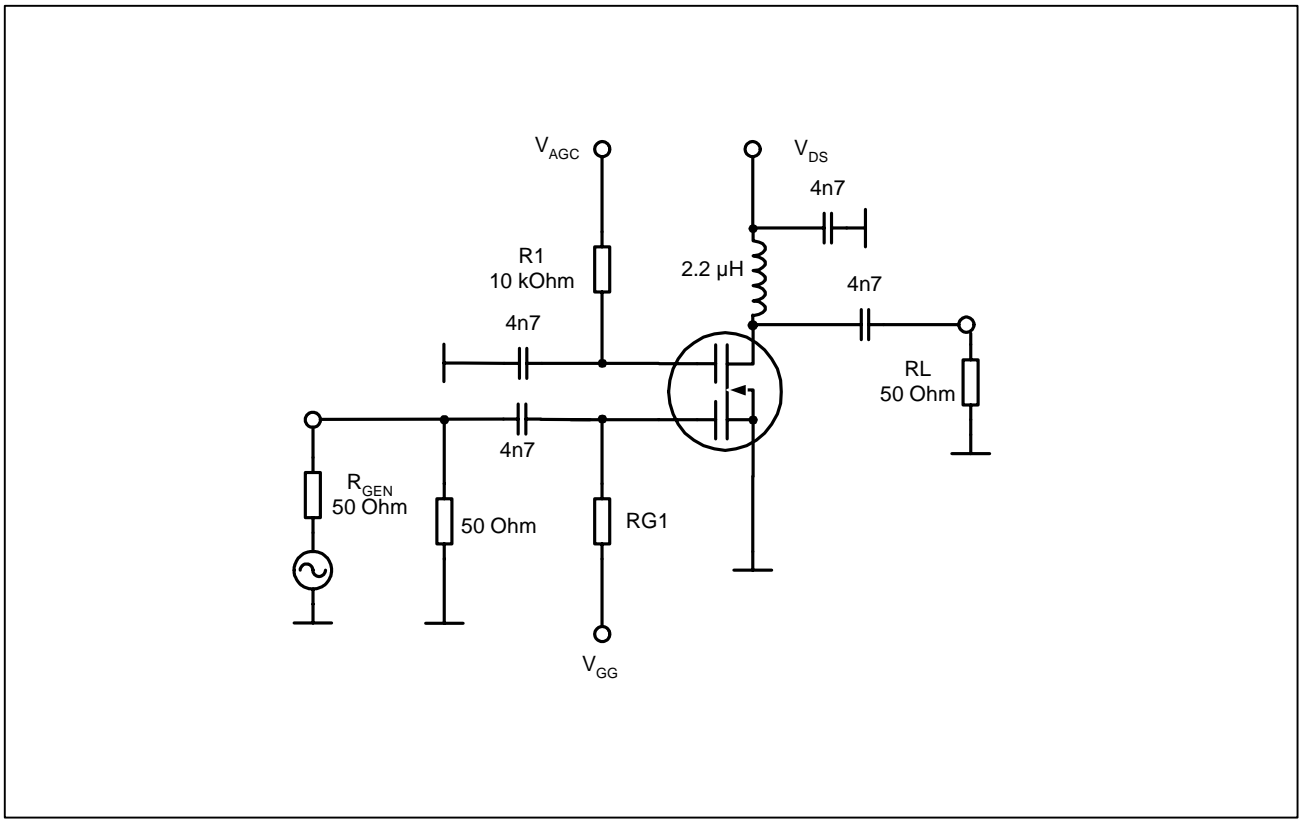

Package Outline

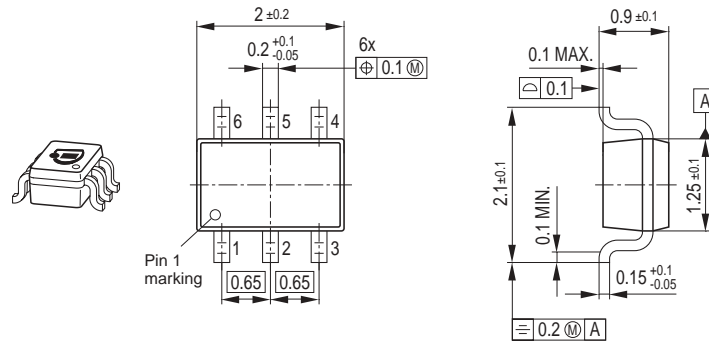

Foot Print

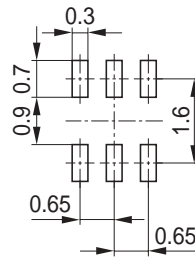

Marking Layout

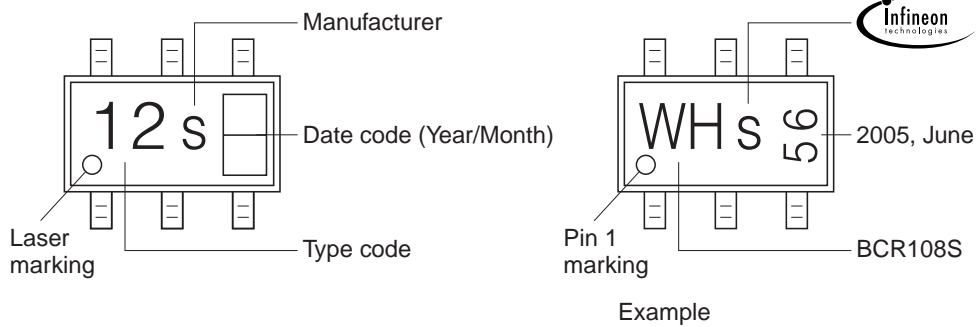

Standard Packing

Reel $\varnothing 180$ mm = 3.000 Pieces/Reel
 Reel $\varnothing 330$ mm = 10.000 Pieces/Reel

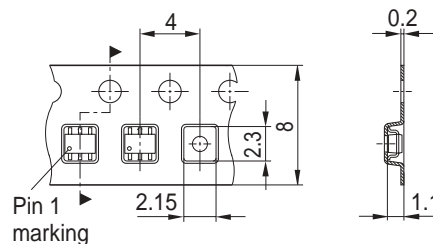

Published by Infineon Technologies AG,
St.-Martin-Strasse 53,
81669 München
© Infineon Technologies AG 2005.
All Rights Reserved.

Attention please!

The information herein is given to describe certain components and shall not be considered as a guarantee of characteristics.

Terms of delivery and rights to technical change reserved.

We hereby disclaim any and all warranties, including but not limited to warranties of non-infringement, regarding circuits, descriptions and charts stated herein.

Information

For further information on technology, delivery terms and conditions and prices please contact your nearest Infineon Technologies Office (www.infineon.com).

Warnings

Due to technical requirements components may contain dangerous substances. For information on the types in question please contact your nearest Infineon Technologies Office.

Infineon Technologies Components may only be used in life-support devices or systems with the express written approval of Infineon Technologies, if a failure of such components can reasonably be expected to cause the failure of that life-support device or system, or to affect the safety or effectiveness of that device or system. Life support devices or systems are intended to be implanted in the human body, or to support and/or maintain and sustain and/or protect human life. If they fail, it is reasonable to assume that the health of the user or other persons may be endangered.

Looking for pricing, stock, or lifecycle information?

Click below to explore more details on WIN SOURCE:

-  [View BG3230 E6327 on WIN SOURCE](#)
-  [Infineon Technologies Information](#)

Optimize Your Supply Chain with WIN SOURCE Solutions

-  Global Sourcing Solution
-  Obsolete Management
-  Cost Control Management
-  Shortage Management
-  Alternative Solution
-  Excess Inventory Management