



**THE DATASHEET OF
BG5120KE6327HTSA1**



Dual N-Channel MOSFET Tetrode

- Low noise gain controlled input stages for UHF and VHF -tuners e. g. (NTSC, PAL)
- Two AGC amplifiers in one single package
- Integrated gate protection diodes
- Low noise figure, high AGC-range
- Improved cross modulation at gain reduction
- Pb-free (RoHS compliant) package
- Qualified according AEC Q101

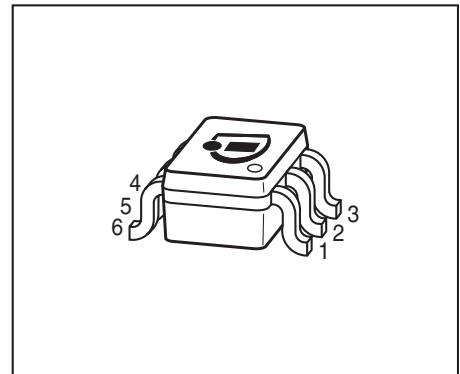
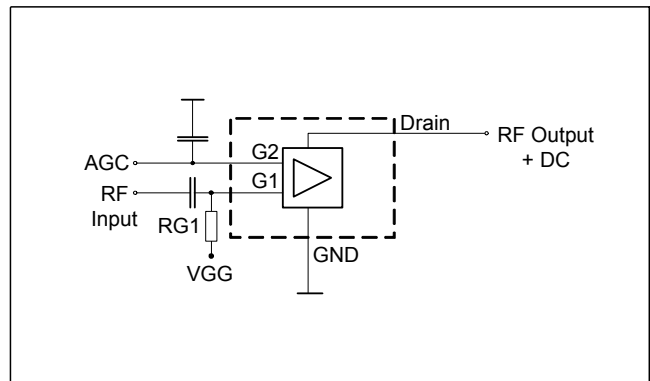
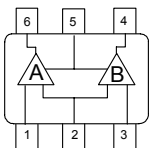
BG5120K

ESD (Electrostatic discharge) sensitive device, observe handling precaution!

Type	Package	Pin Configuration						Marking
BG5120K	SOT363	1=G1*	2=G2	3=G1**	4=D**	5=S	6=D*	K1

* For amp. A; ** for amp. B

180° rotated tape loading orientation available

Maximum Ratings

Parameter	Symbol	Value	Unit
Drain-source voltage	V_{DS}	8	V
Continuous drain current	I_D	20	mA
Gate 1/ gate 2-source current	$\pm I_{G1/2SM}$	1	
Gate 1/ gate 2-source voltage	$\pm V_{G1/G2S}$	6	V
Total power dissipation	P_{tot}	200	mW
Storage temperature	T_{stg}	-55 ... 150	°C
Channel temperature	T_{ch}	150	

Thermal Resistance

Parameter	Symbol	Value	Unit
Channel - soldering point ¹⁾	R_{thchs}	≤ 280	K/W

¹⁾For calculation of R_{thJA} please refer to Application Note Thermal Resistance

Electrical Characteristics at $T_A = 25^\circ\text{C}$, unless otherwise specified

Parameter	Symbol	Values			Unit
		min.	typ.	max.	

DC Characteristics

Drain-source breakdown voltage $I_D = 10 \mu\text{A}$, $V_{G1S} = 0$, $V_{G2S} = 0$	$V_{(BR)DS}$	12	-	-	V
Gate1-source breakdown voltage $+I_{G1S} = 10 \text{mA}$, $V_{G2S} = 0$, $V_{DS} = 0$	$+V_{(BR)G1SS}$	6	-	15	
Gate2-source breakdown voltage $+I_{G2S} = 10 \text{mA}$, $V_{G1S} = 0$, $V_{DS} = 0$	$+V_{(BR)G2SS}$	6	-	15	
Gate1-source leakage current $V_{G1S} = 6 \text{V}$, $V_{G2S} = 0$, $V_{DS} = 0$	$+I_{G1SS}$	-	-	50	μA
Gate2-source leakage current $V_{G2S} = 6 \text{V}$, $V_{G1S} = 0$, $V_{DS} = 0$	$+I_{G2SS}$	-	-	50	nA
Drain current $V_{DS} = 5 \text{V}$, $V_{G1S} = 0$, $V_{G2S} = 4 \text{V}$	I_{DSS}	-	-	10	μA
Drain-source current $V_{DS} = 5 \text{V}$, $V_{G2S} = 4 \text{V}$, $R_{G1} = 100 \text{k}\Omega$	I_{DSX}	-	12	-	mA
Gate1-source pinch-off voltage $V_{DS} = 5 \text{V}$, $V_{G2S} = 4 \text{V}$, $I_D = 20 \mu\text{A}$	$V_{G1S(p)}$	-	0.7	-	V
Gate2-source pinch-off voltage $V_{DS} = 5 \text{V}$, $I_D = 20 \mu\text{A}$, $V_{G1S} = 2 \text{V}$	$V_{G2S(p)}$	-	0.6	-	

Electrical Characteristics at $T_A = 25^\circ\text{C}$, unless otherwise specified

Parameter	Symbol	Values			Unit
		min.	typ.	max.	
AC Characteristics $V_{DS}=5\text{V}$, $V_{G2S}=4\text{V}$, ($I_D=10\text{mA}$) (verified by random sampling)					
Forward transconductance	g_{fs}	-	30	-	mS
Gate1 input capacitance $f = 10\text{ MHz}$	C_{g1ss}	-	2.2	-	pF
Output capacitance $f = 10\text{ MHz}$	C_{dss}	-	1.4	-	
Power gain 800 MHz 45 MHz	G_p	- -	23 30	- -	dB
Noise figure 800 MHz 45 MHz , 45 MHz	F	- -	1.1 0.7	- -	dB
Gain control range $V_{G2S} = 4 \dots 0\text{ V}$, $f = 800\text{ MHz}$	ΔG_p	45	-	-	
Cross-modulation $k=1\%$, $f_W=50\text{MHz}$, $f_{unw}=60\text{MHz}$ AGC = 0 dB AGC = 10 dB AGC = 40 dB	X_{mod}	90 - 96	- 87 100	- - -	dB μ V

Total power dissipation $P_{tot} = f(T_S)$

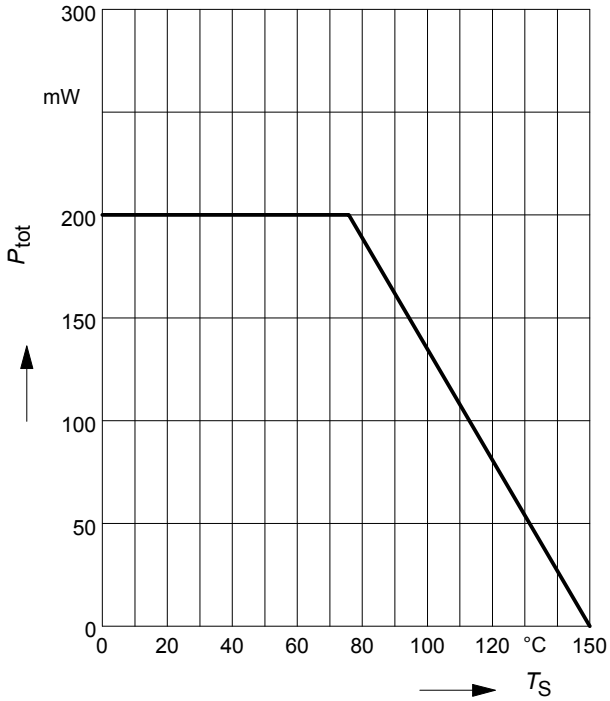

Drain current $I_D = f(I_{G1})$

$V_{G2S} = 4V$

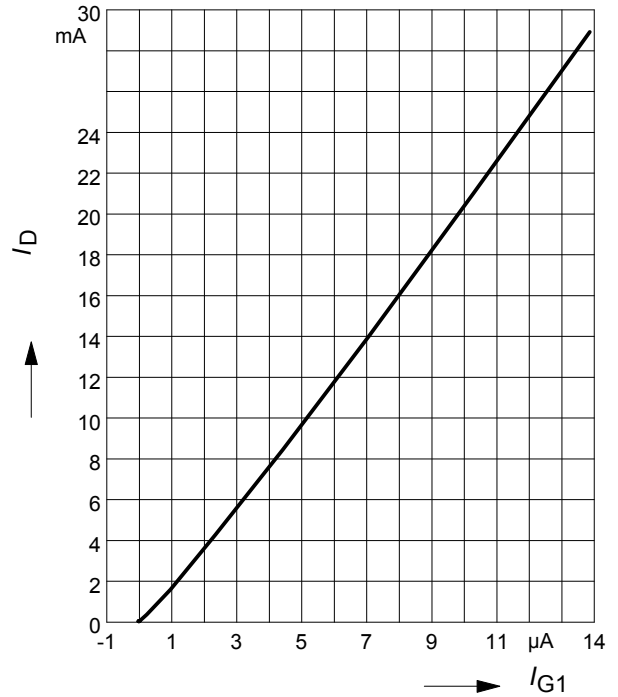

Output characteristics $I_D = f(V_{DS})$

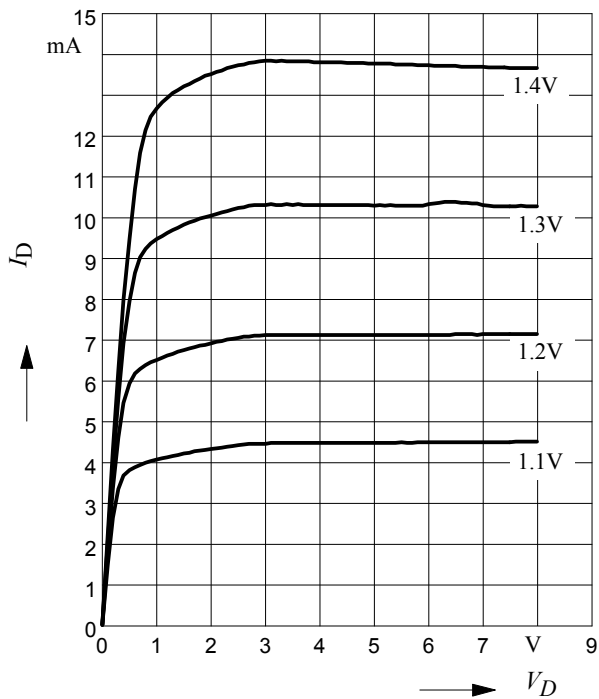

Gate 1 current $I_{G1} = f(V_{G1S})$

$V_{DS} = 5V$

$V_{G2S} = \text{Parameter}$

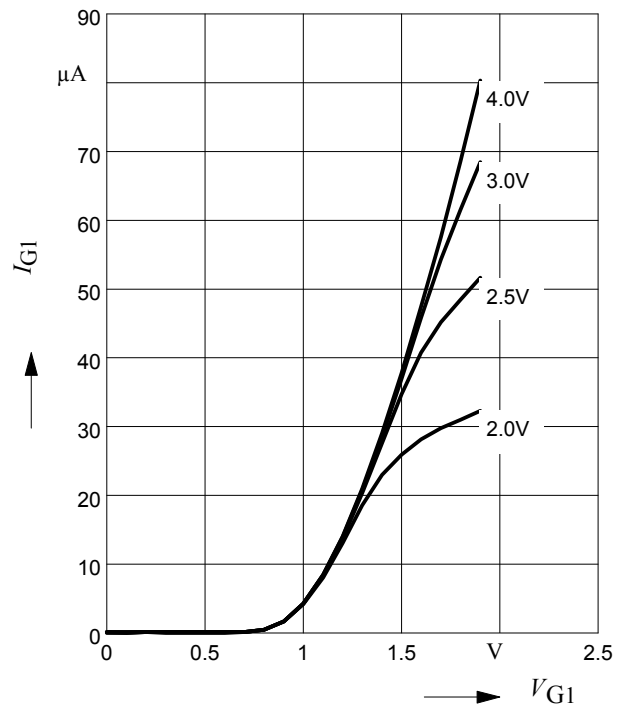

Gate 1 forward transconductance

$$g_{fs} = f(I_D)$$

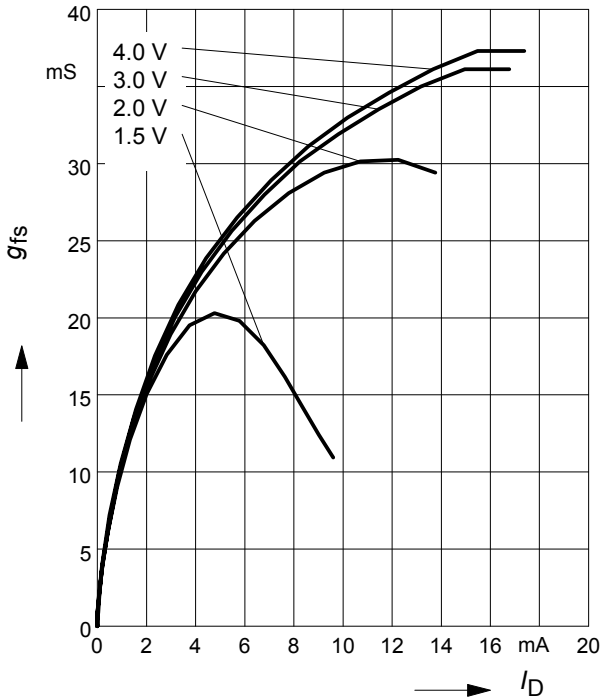
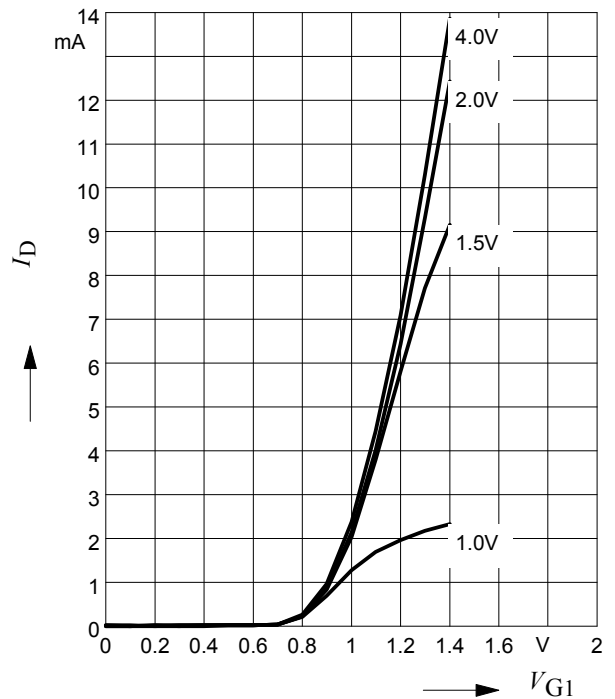
 $V_{DS} = 5V, V_{G2S} = \text{Parameter}$

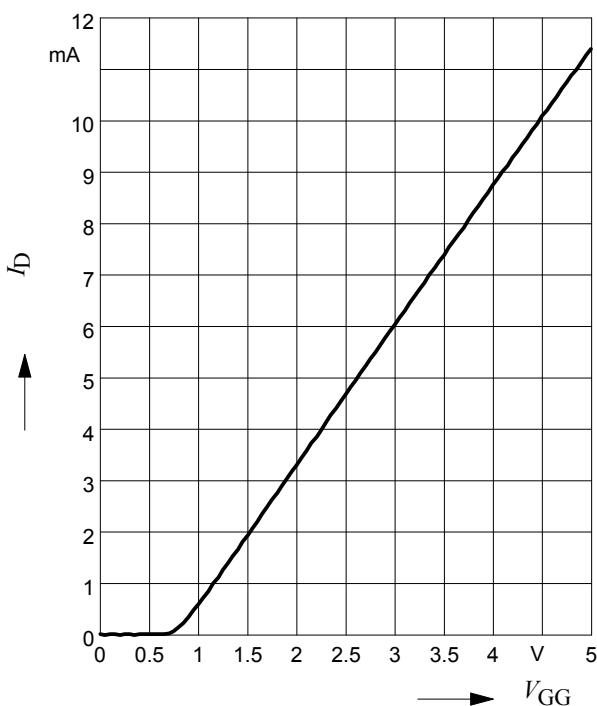
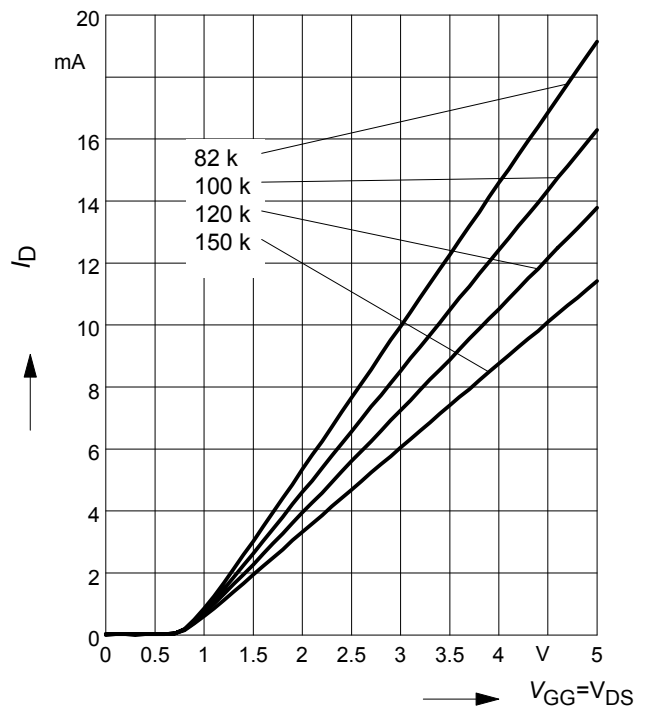
Drain current $I_D = f(V_{G1S})$
 $V_{DS} = 5V$
 $V_{G2S} = \text{Parameter}$

Drain current $I_D = f(V_{GG})$
 $V_{DS} = 5V, V_{G2S} = 4V, R_{G1} = 150k\Omega$

 (connected to V_{GG} , $V_{GG} = \text{gate1 supply voltage}$)

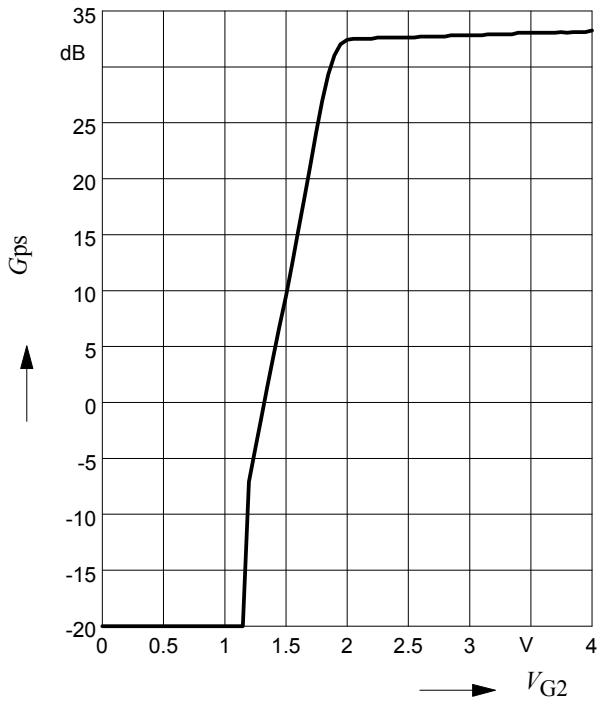
Drain current $I_D = f(V_{GG})$
 $V_{DS} = 5V, V_{G2S} = 4V$
 $R_{G1} = \text{Parameter in } k\Omega$

Power gain $G_{ps} = f(V_{G2S})$

$f = 45\text{MHz}$



Noise figure $F = f(V_{G2S})$

$f = 45\text{MHz}$

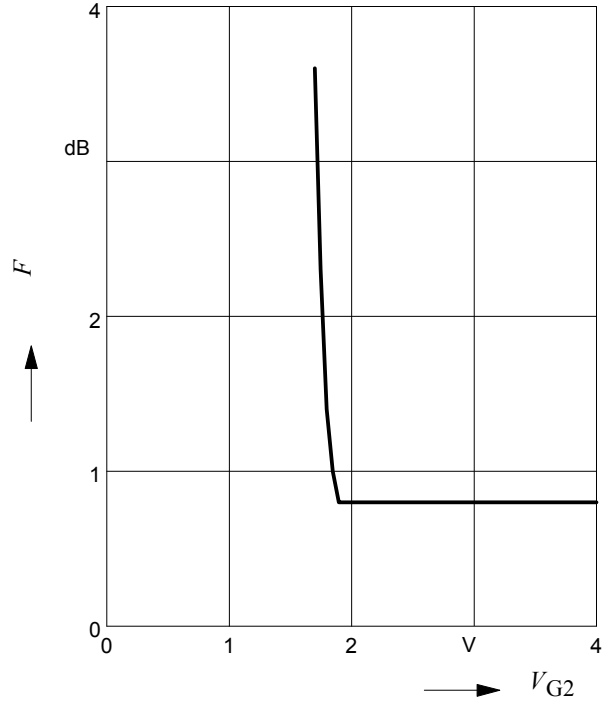

Noise figure $F = f(V_{G2S})$

$f = 800\text{MHz}$

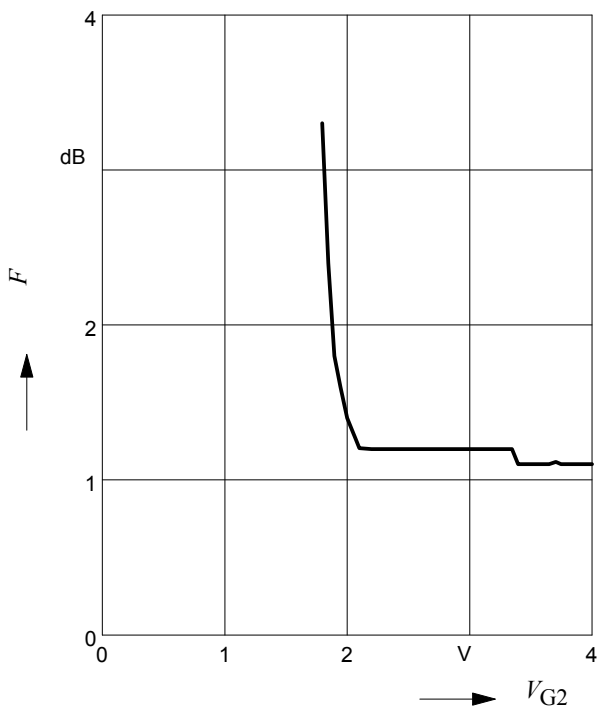

Power gain $G_{ps} = f(V_{G2S})$

$f = 800\text{GHz}$

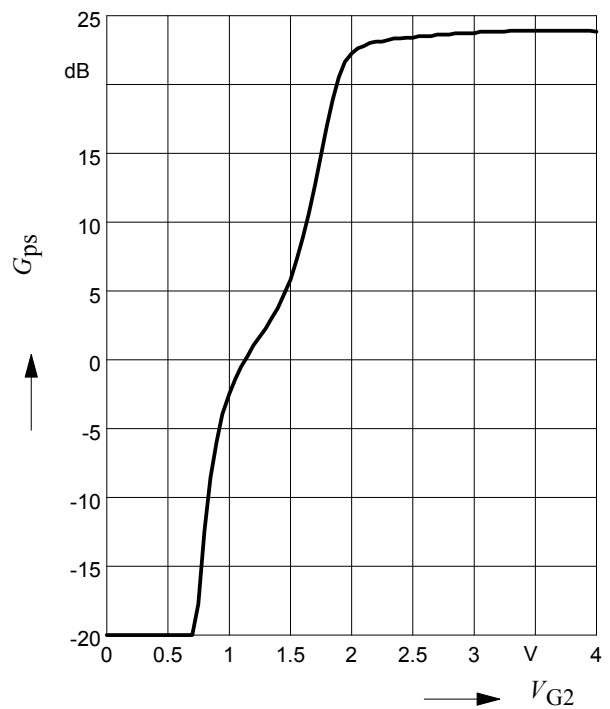

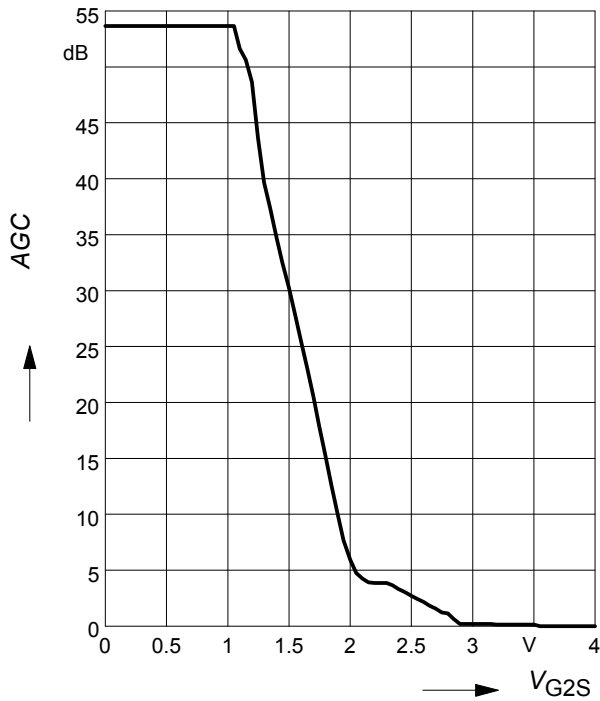
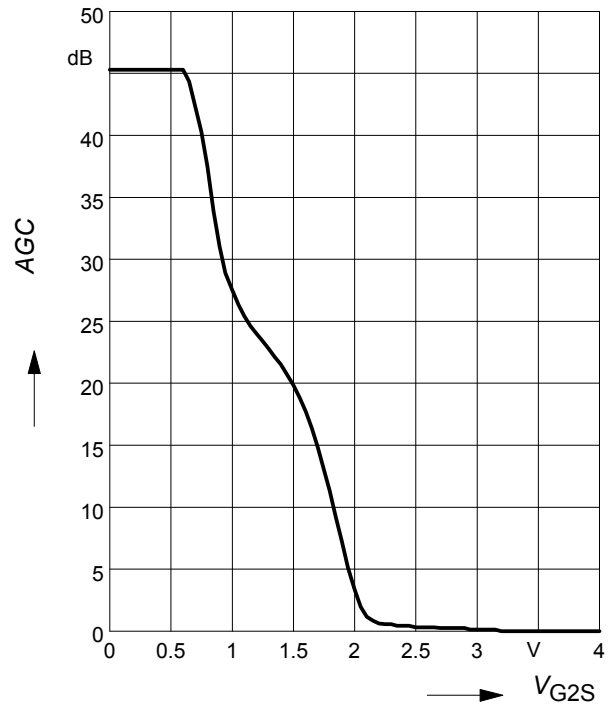
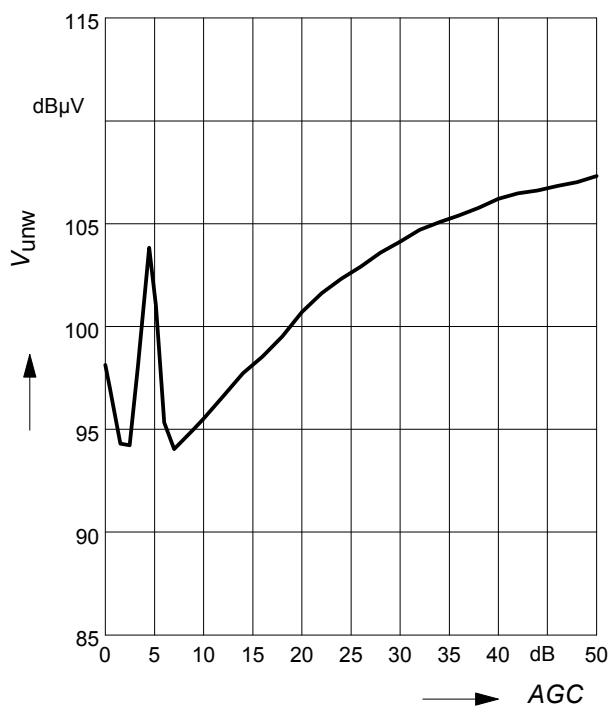
AGC characteristic $AGC = f(V_{G2S})$
 $V_{DS} = 5\text{ V}, R_{GG} = 120\text{ k}\Omega, f = 45\text{ MHz}$

AGC characteristic $AGC = f(V_{G2S})$
 $V_{DS} = 5\text{ V}, R_{GG} = 120\text{ k}\Omega, f = 800\text{ MHz}$

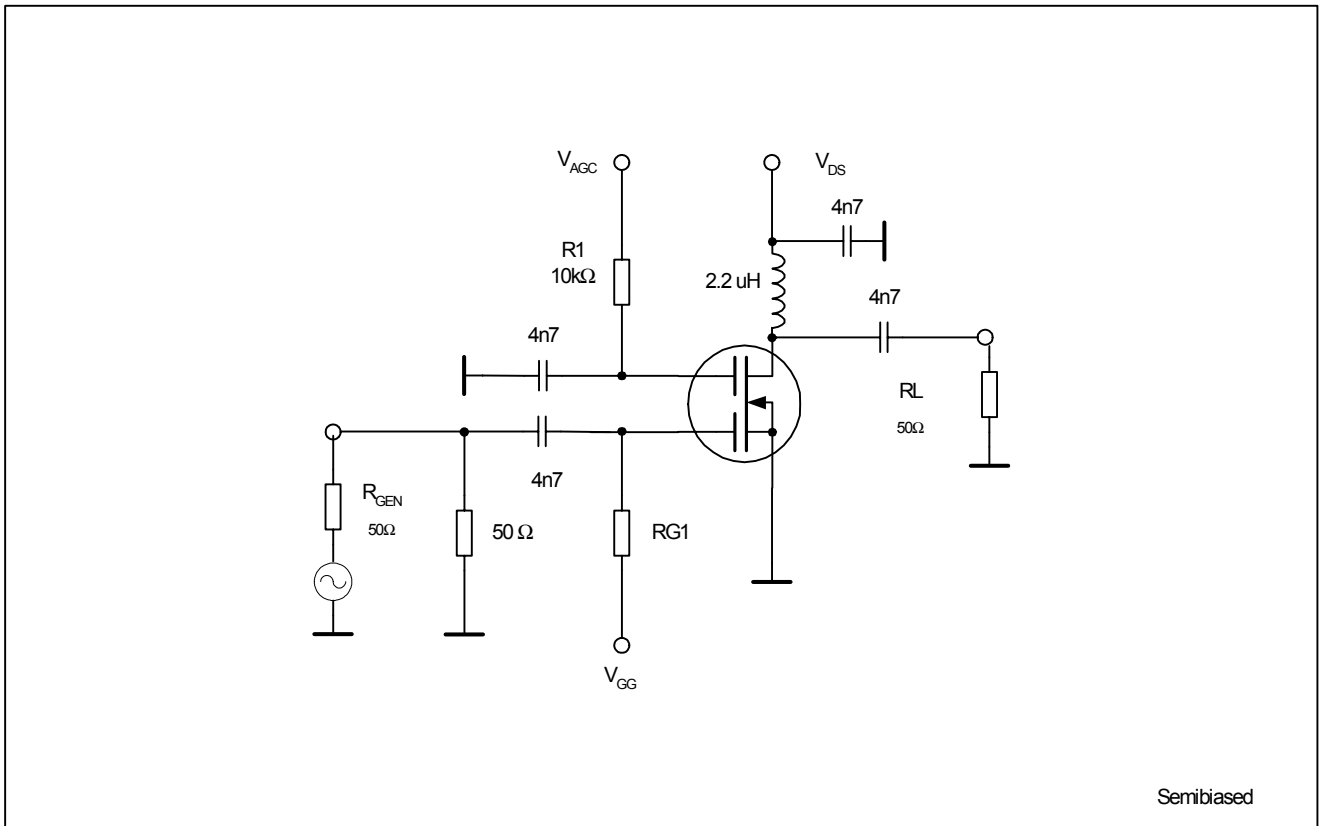
Crossmodulation $V_{unw} = (AGC)$
 $V_{DS} = 5\text{ V}, I_D = 14\text{ mA}$

Crossmodulation test circuit

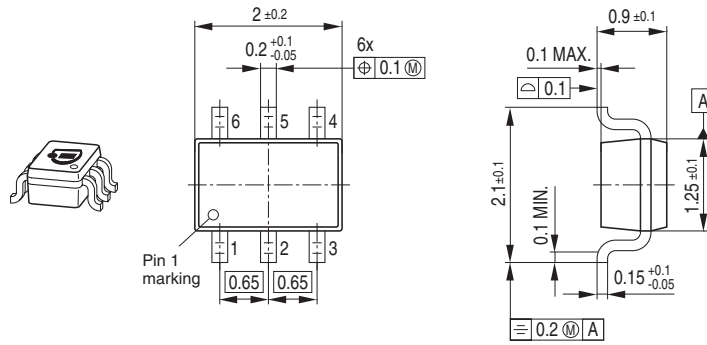

Package Outline



Foot Print

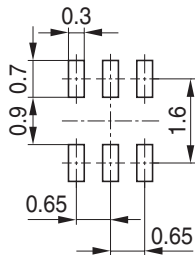

Marking Layout (Example)

Small variations in positioning of Date code, Type code and Manufacture are possible.

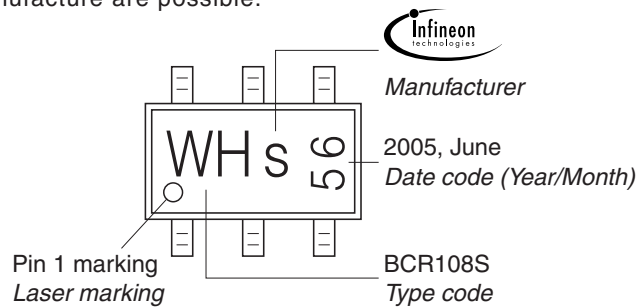

Standard Packing

Reel \varnothing 180 mm = 3.000 Pieces/Reel
 Reel \varnothing 330 mm = 10.000 Pieces/Reel

For symmetric types no defined Pin 1 orientation in reel.

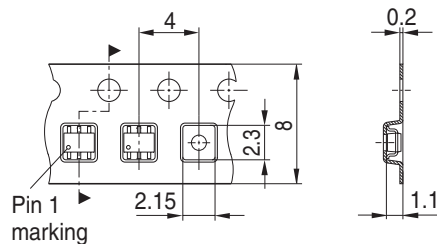

Edition 2006-02-01

Published by

Infineon Technologies AG

81726 München, Germany

© Infineon Technologies AG 2007.

All Rights Reserved.

Attention please!

The information given in this dokument shall in no event be regarded as a guarantee of conditions or characteristics ("Beschaffenheitsgarantie"). With respect to any examples or hints given herein, any typical values stated herein and/or any information regarding the application of the device, Infineon Technologies hereby disclaims any and all warranties and liabilities of any kind, including without limitation warranties of non-infringement of intellectual property rights of any third party.

Information

For further information on technology, delivery terms and conditions and prices please contact your nearest Infineon Technologies Office (www.infineon.com).

Warnings



Due to technical requirements components may contain dangerous substances. For information on the types in question please contact your nearest Infineon Technologies Office.

Infineon Technologies Components may only be used in life-support devices or systems with the express written approval of Infineon Technologies, if a failure of such components can reasonably be expected to cause the failure of that life-support device or system, or to affect the safety or effectiveness of that device or system.

Life support devices or systems are intended to be implanted in the human body, or to support and/or maintain and sustain and/or protect human life. If they fail, it is reasonable to assume that the health of the user or other persons may be endangered.

Looking for pricing, stock, or lifecycle information?

Click below to explore more details on WIN SOURCE:

-  [View BG5120KE6327HTSA1 on WIN SOURCE](#)
-  [Infineon Technologies Information](#)

Optimize Your Supply Chain with WIN SOURCE Solutions

-  Global Sourcing Solution
-  Obsolete Management
-  Cost Control Management
-  Shortage Management
-  Alternative Solution
-  Excess Inventory Management