



**THE DATASHEET OF  
BG5412KE6327HTSA1**



**Dual N-Channel MOSFET Tetrode**

- Designed for input stages of 2 band tuners
- Two AGC amplifiers in one single package, with on-chip internal switch
- Only one switching line to control both FETs
- Integrated gate protection diodes
- Ultra low noise figure
- Excellent cross modulation at gain reduction
- Integrated ESD gate protection diodes
- Pb-free (RoHS compliant) package
- Qualified according AEC Q101

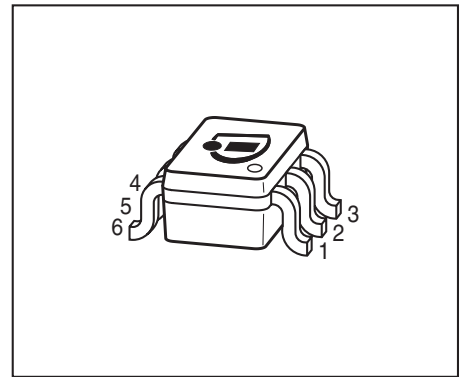

Detailed functional diagram on page 5

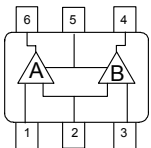
**BG5412K**

**ESD (Electrostatic discharge) sensitive device, observe handling precaution!**

Type	Package	Pin Configuration						Marking
BG5412K	SOT363	1=G1*	2=G2	3=G1**	4=D**	5=S	6=D*	K2s

\* For amp. A; \*\* for amp. B

180° rotated tape loading orientation available

**Maximum Ratings**

Parameter	Symbol	Value	Unit
Drain-source voltage	$V_{DS}$	8	V
Continuous drain current amp. A	$I_D$	25	mA
amp. B		25	
Gate 1/ gate 2-source current	$I_{G1S}, I_{G2S}$	$\pm 1$	mA
Gate 1/ gate 2-source voltage	$V_{G1S}, V_{G2S}$	$\pm 6$	V
Total power dissipation $T_S \leq 94 \text{ }^\circ\text{C}$	$P_{tot}$	200	mW
Storage temperature	$T_{stg}$	-55 ... 150	$^\circ\text{C}$
Channel temperature	$T_{ch}$	150	

**Thermal Resistance**

Parameter	Symbol	Value	Unit
Channel - soldering point <sup>1)</sup>	$R_{thchs}$	$\leq 280$	K/W

<sup>1)</sup>For calculation of  $R_{thJA}$  please refer to Application Note Thermal Resistance

**Electrical Characteristics** at  $T_A = 25^\circ\text{C}$ , unless otherwise specified

Parameter	Symbol	Values			Unit
		min.	typ.	max.	
<b>DC Characteristics</b>					
Drain-source breakdown voltage $I_D = 100 \mu\text{A}$ , $V_{G1S} = 0$ , $V_{G2S} = 0$	$V_{(BR)DS}$	12	-	-	V
Gate1-source breakdown voltage $+I_{G1S} = 10 \text{ mA}$ , $V_{G2S} = 0$ , $V_{DS} = 0$	$+V_{(BR)G1SS}$	6	-	15	
Gate2-source breakdown voltage $+I_{G2S} = 10 \text{ mA}$ , $V_{G1S} = 0$ , $V_{DS} = 0$	$+V_{(BR)G2SS}$	6	-	15	
Gate1-source leakage current $V_{G1S} = 6 \text{ V}$ , $V_{G2S} = 0$ , $V_{DS} = 0$	$+I_{G1SS}$	-	-	50	nA
Gate2-source leakage current $V_{G2S} = 8 \text{ V}$ , $V_{G1S} = 0$	$+I_{G2SS}$	-	-	50	
Drain current $V_{DS} = 5 \text{ V}$ , $V_{G1S} = 0$ , $V_{G2S} = 4 \text{ V}$	$I_{DSS}$	-	-	100	$\mu\text{A}$
Drain-source current $V_{DS} = 5 \text{ V}$ , $V_{G2S} = 4 \text{ V}$ , $R_{G1} = 120 \text{ k}\Omega$ , amp. B $V_{DS} = 5 \text{ V}$ , $V_{G2S} = 4 \text{ V}$ , selfbiased, amp. A	$I_{DSX}$	-	14 18	-	mA
Gate1-source pinch-off voltage $V_{DS} = 5 \text{ V}$ , $V_{G2S} = 4 \text{ V}$ , $I_D = 100 \mu\text{A}$	$V_{G1S(p)}$	-	0.7	-	V
Gate2-source pinch-off voltage $V_{DS} = 5 \text{ V}$ , $I_D = 100 \mu\text{A}$	$V_{G2S(p)}$	-	0.7	-	

**Electrical Characteristics at  $T_A = 25^\circ\text{C}$ , unless otherwise specified**

Parameter	Symbol	Values			Unit
		min.	typ.	max.	
<b>AC Characteristics <math>V_{DS} = 5\text{ V}</math>, <math>V_{G2} = 4\text{ V}</math>, <math>I_D = 10\text{ mA}</math> (verified by random sampling)</b>					
Forward transconductance amp. A amp. B	$g_{fs}$	- - -	33 30	- - -	mS
Gate1 input capacitance amp. A amp. B	$C_{g1ss}$	- -	2.2 2	- -	pF
Output capacitance amp. A amp. B	$C_{dss}$	- -	0.9 0.8	- -	
Power gain $f = 800\text{ MHz}$ , amp. A $f = 800\text{ MHz}$ , amp. B $f = 45\text{ MHz}$ , amp. A $f = 45\text{ MHz}$ , amp. B	$G_p$	- - - -	24 24 34 31	- - - -	dB
Noise figure $f = 800\text{ MHz}$ , amp. A $f = 800\text{ MHz}$ , amp. B $f = 45\text{ MHz}$ , amp. A $f = 45\text{ MHz}$ , amp. B	$F$	- - - -	1.1 1.2 0.8 0.9	- - - -	dB
Gain control range $V_{G2S} = 4\dots 0\text{ V}$ , $f = 800\text{ MHz}$	$\Delta G_p$	-	45	-	
Cross-modulation $k=1\%$ , $f_W=50\text{MHz}$ , $f_{unw}=60\text{MHz}$ amp. A, AGC = 0 dB amp. B, AGC = 0 dB amp. A, AGC = 10 dB amp. B, AGC = 10 dB amp. A, AGC = 40 dB amp. B, AGC = 40 dB	$X_{mod}$	- - - - - -	97 96 94 91 105 103	- - - - - -	-

**Functional diagram**

shows pinning of BG5412K, switching pin at PIN 3

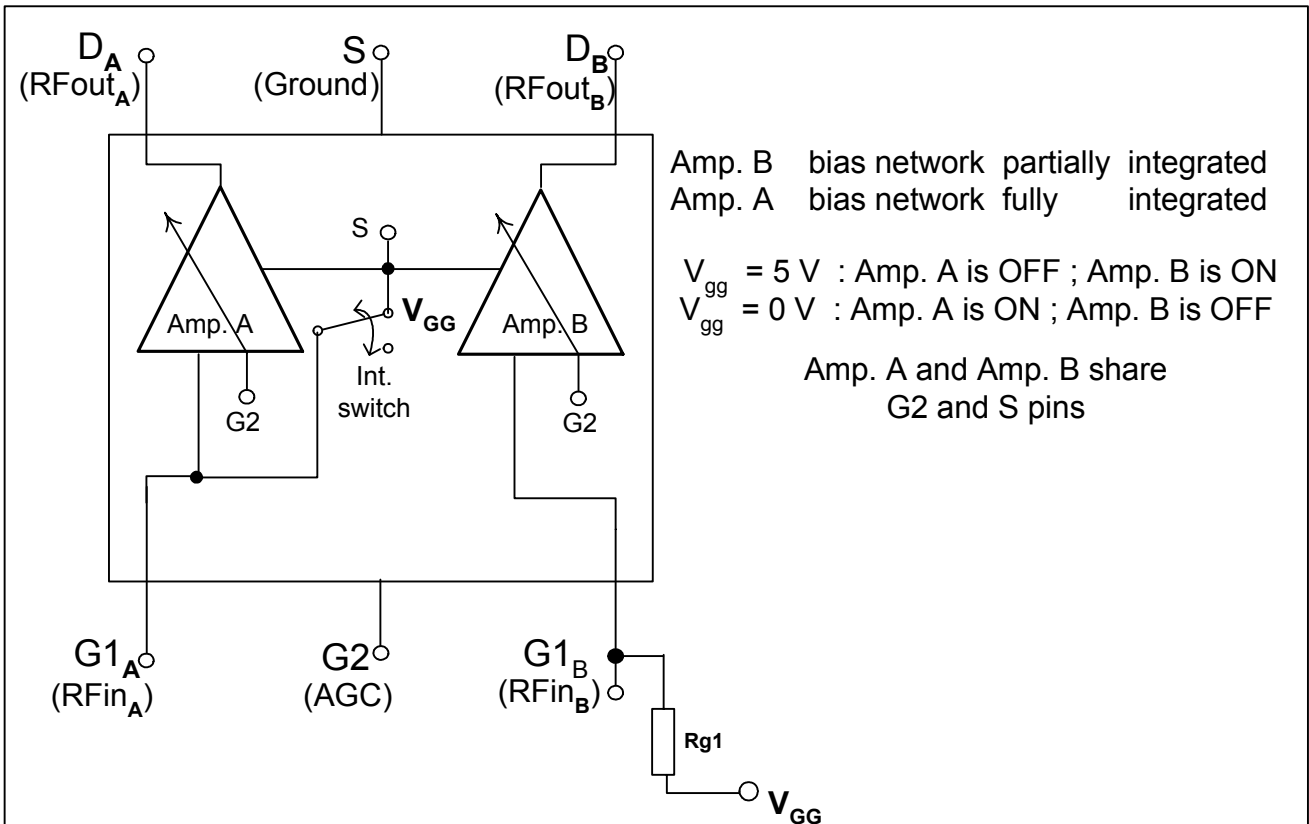

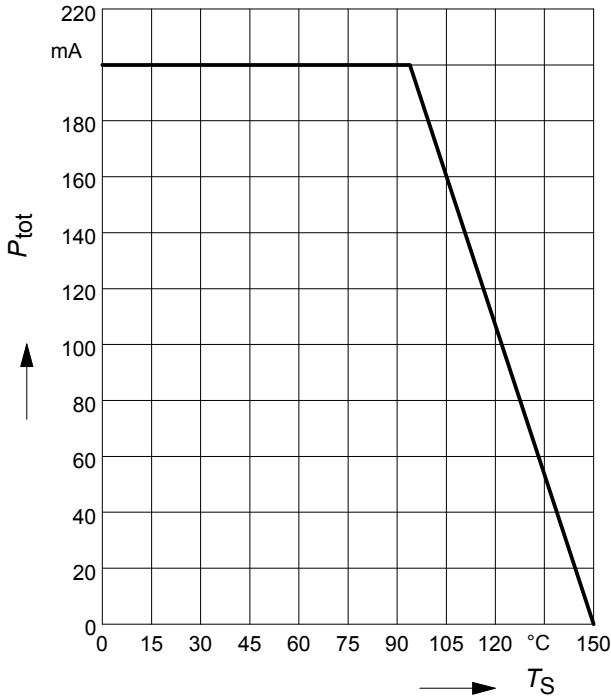
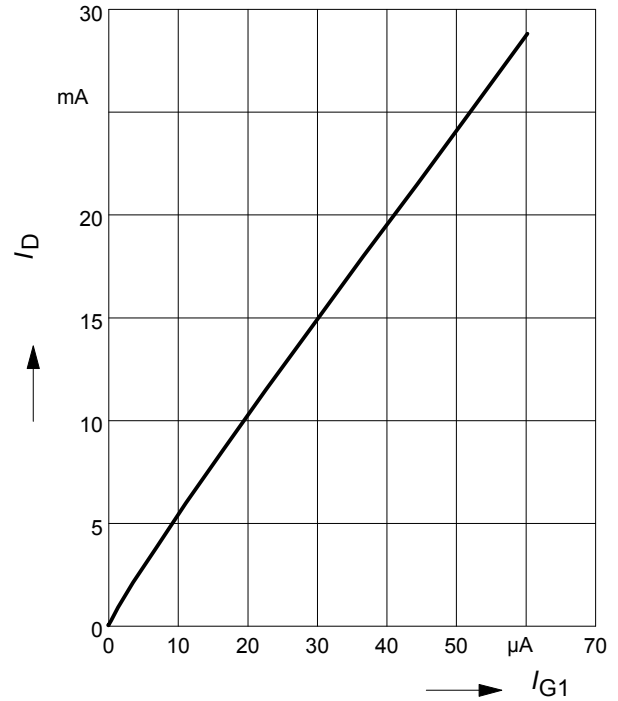
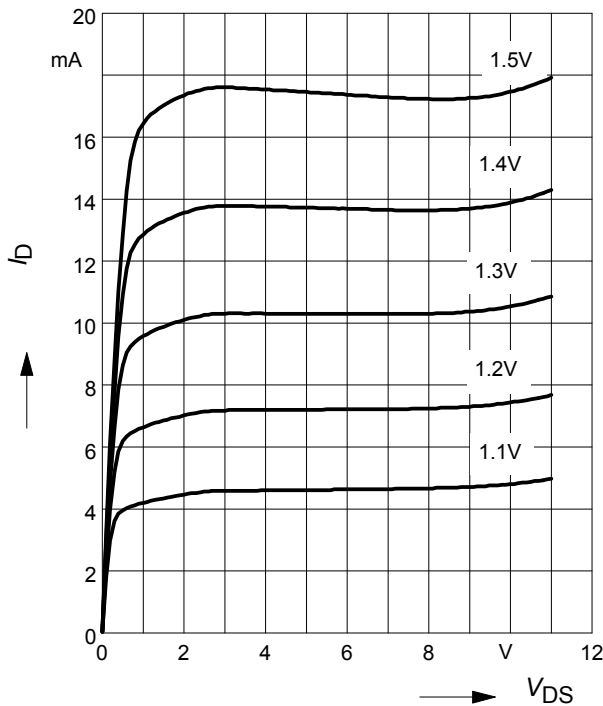
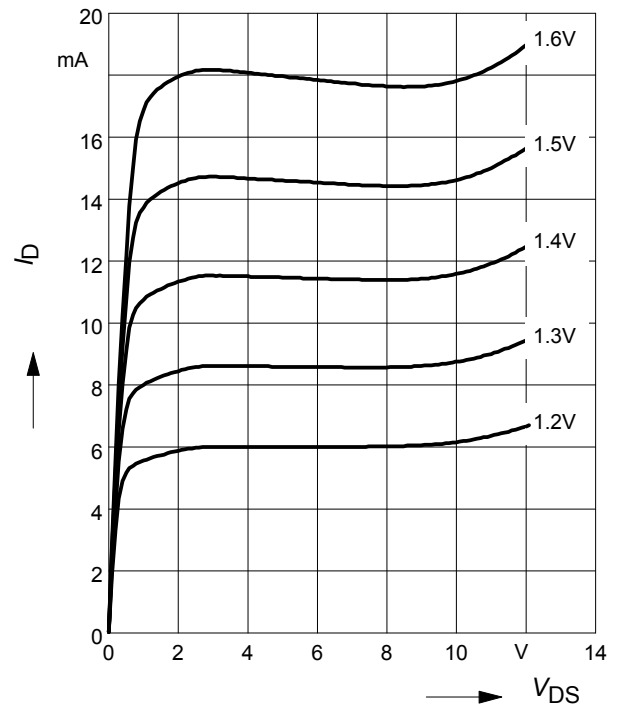
**Total power dissipation  $P_{\text{tot}} = f(T_S)$** 

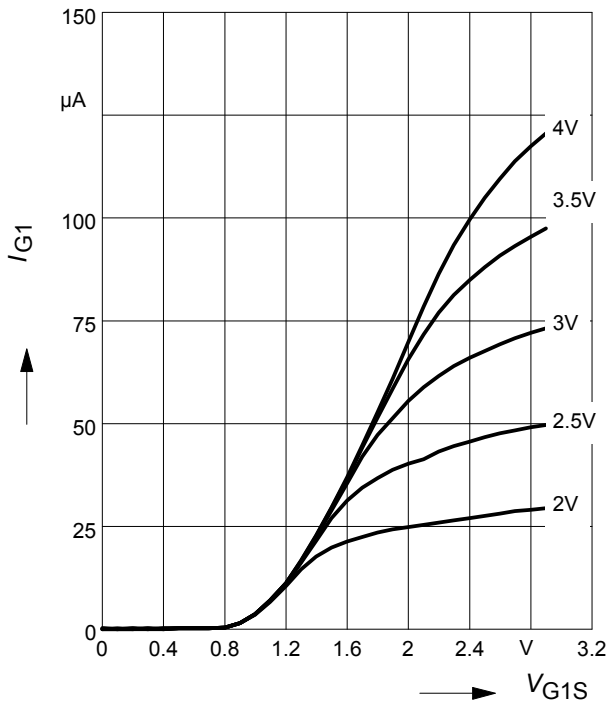
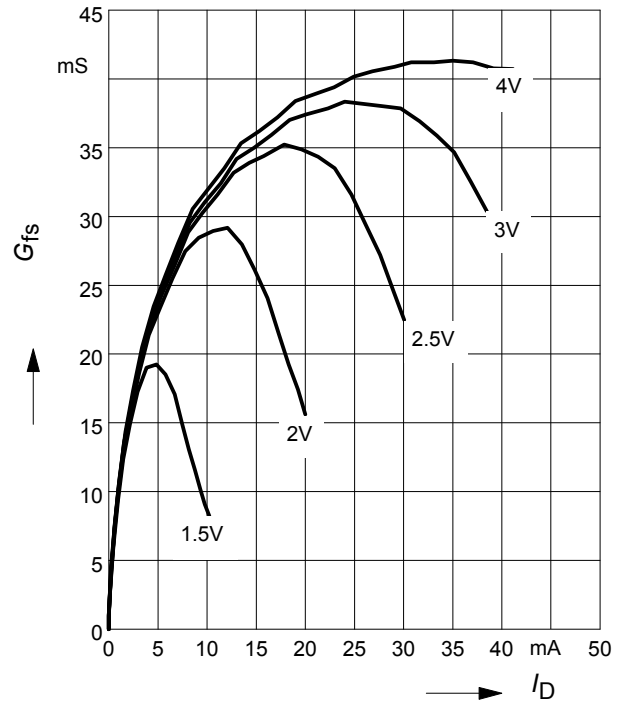
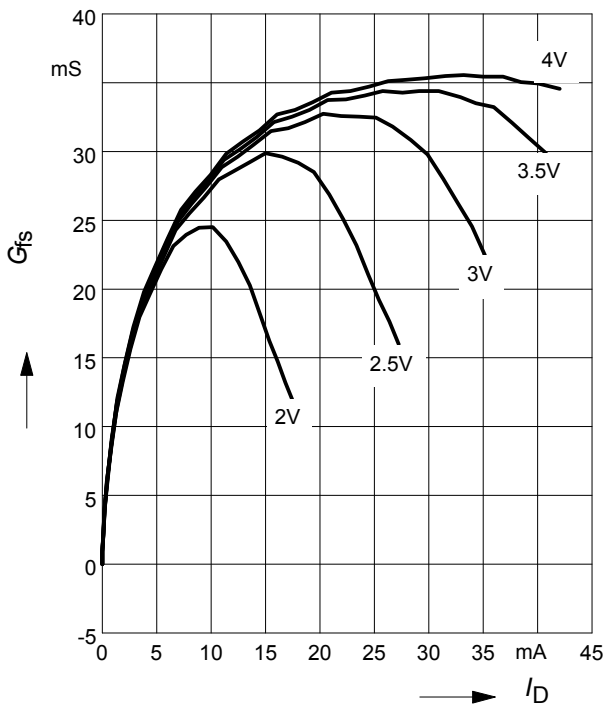
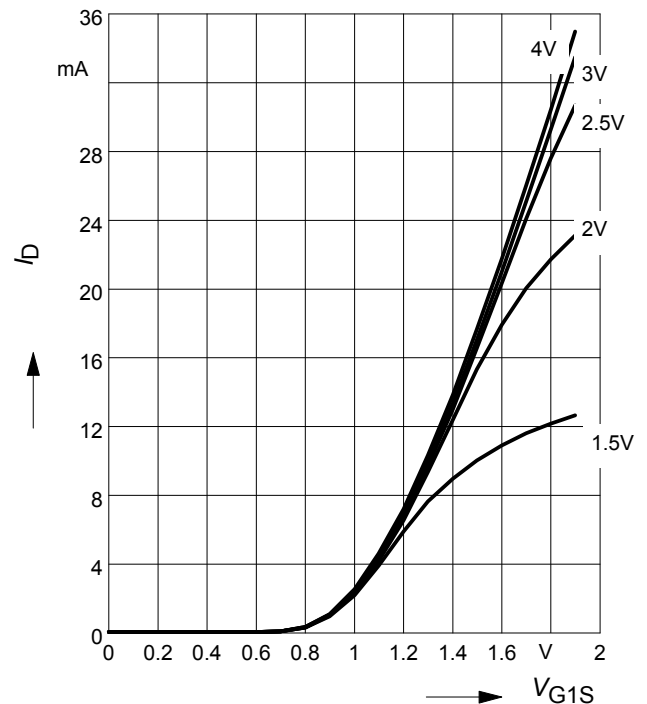
**Drain current  $I_D = f(I_{G1})$** 
 $V_{G2S} = 4V, \text{ amp. B}$ 
 $V_{DS} = 5V$ 

**Output characteristics  $I_D = f(V_{DS})$** 
 $V_{G2} = 4V, \text{ amp. A}$ 
 $V_{G1} = \text{Parameter}$ 

**Output characteristics  $I_D = f(V_{DS})$** 
 $V_{G2} = 4V, \text{ amp. B}$ 
 $V_{G1} = \text{Parameter}$ 

**Gate 1 current  $I_{G1} = f(V_{G1S})$** 
 $V_{DS} = 5V$ 
 $V_{G2S} = \text{Parameter}$ 

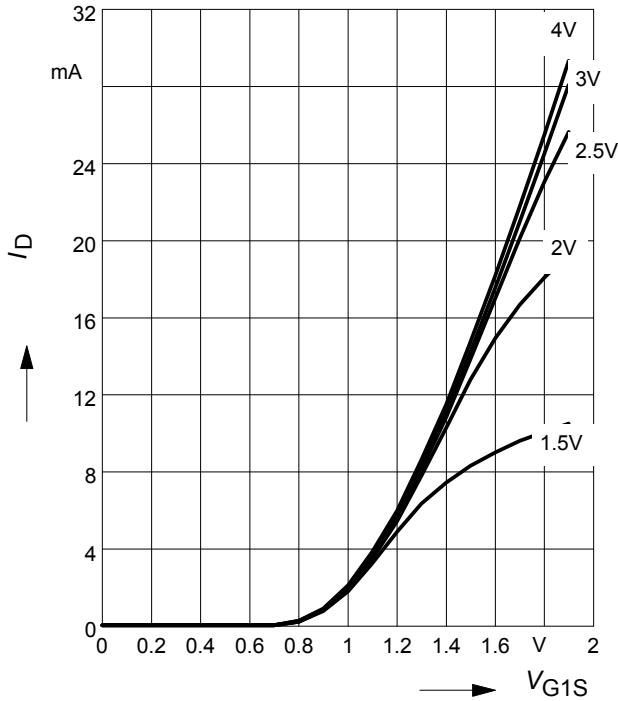
**Gate 1 forward transconductance**
 $g_{fs} = f(I_D); \text{ amp. A}$ 
 $V_{DS} = 5V, V_{G2S} = \text{Parameter}$ 

**Gate 1 forward transconductance**
 $g_{fs} = f(I_D), \text{ amp. B}$ 
 $V_{DS} = 5V, V_{G2S} = \text{Parameter}$ 

**Drain current  $I_D = f(V_{G1S})$** 
 $V_{DS} = 5V, \text{ amp. A}$ 
 $V_{G2S} = \text{Parameter}$ 

**Drain current  $I_D = f(V_{G1S})$**

$V_{DS} = 5V$ , amp. B

$V_{G2S} =$  Parameter



**Drain current  $I_D = f(V_{GG})$ , amp. B**

$V_{DS} = 5V$ ,  $V_{G2S} = 4V$ ,  $R_{G1} = 100k\Omega$

(connected to  $V_{GG}$ ,  $V_{GG} = \text{gate1 supply voltage}$ )

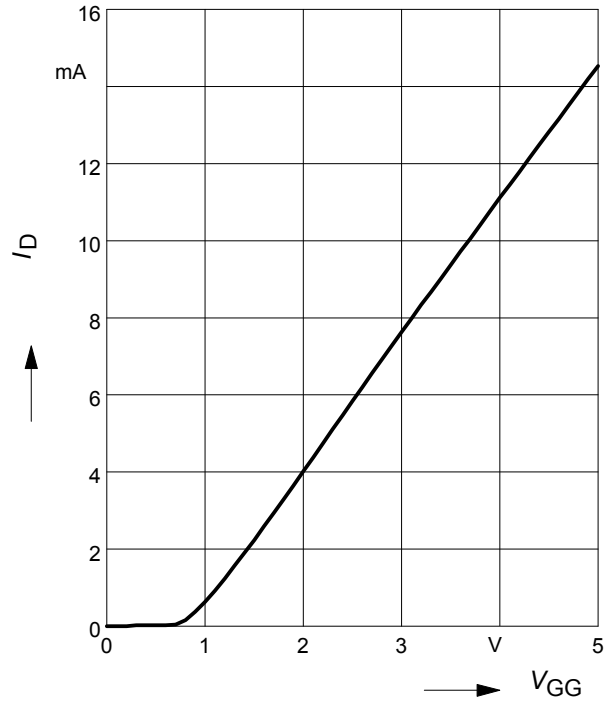

**Drain current  $I_D = f(V_{GG})$ , amp. B**

$V_{DS} = 5V$ ,  $V_{G2S} = 4V$

(connected to  $V_{GG}$ ,  $V_{GG} = \text{gate1 supply voltage}$ )

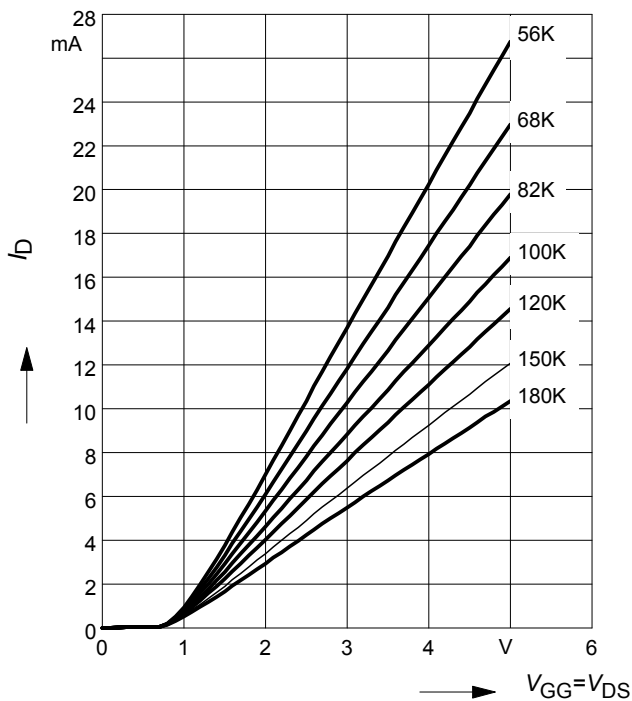

**Drain current of FET A and FET B**

as function of Gate 1 FET B

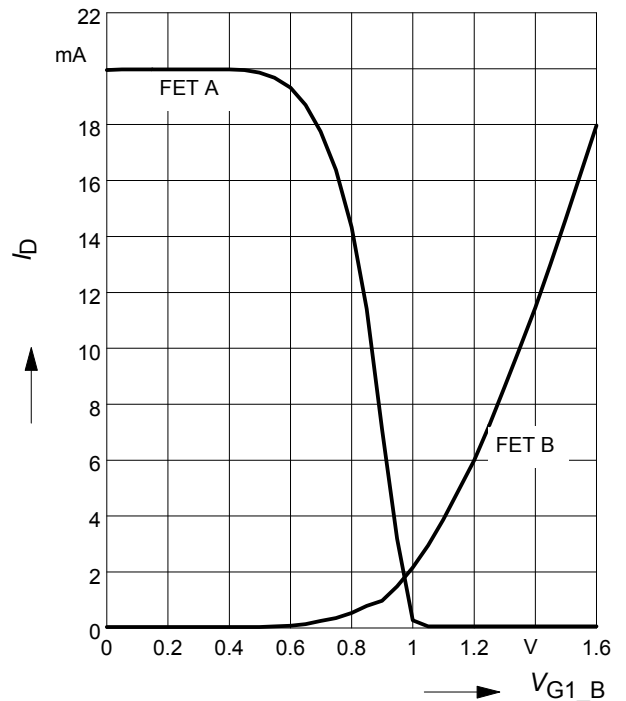

**AGC characteristic  $AGC = f(V_{G2S})$**

$f = 45 \text{ MHz, amp. A}$

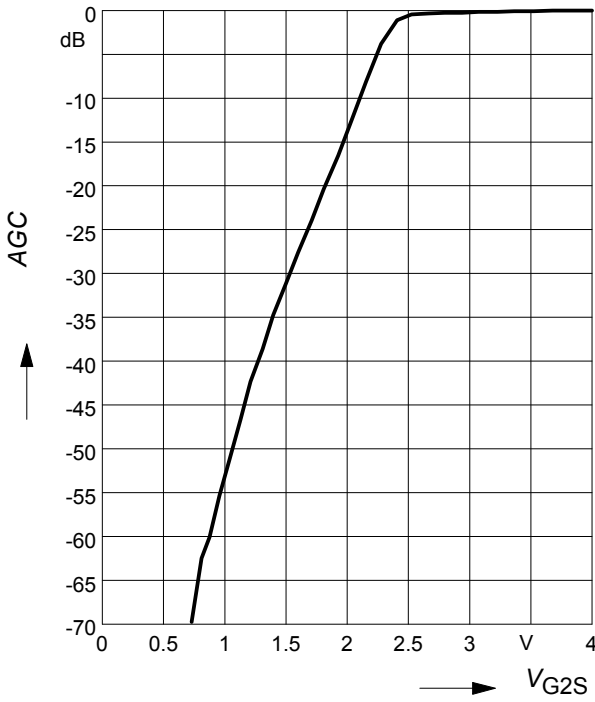

**AGC characteristic  $AGC = f(V_{G2S})$**

$f = 45 \text{ MHz, amp. B}$

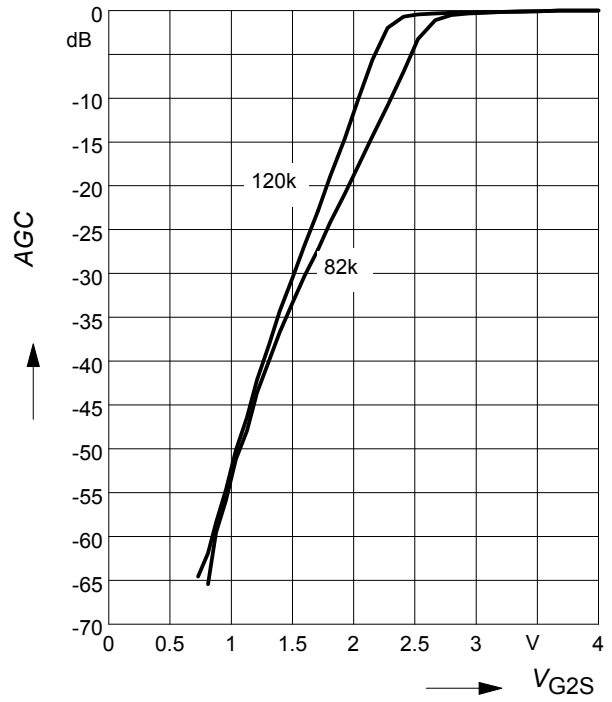

**AGC characteristic  $AGC = f(V_{G2S})$**

$f = 800 \text{ MHz, amp. A}$

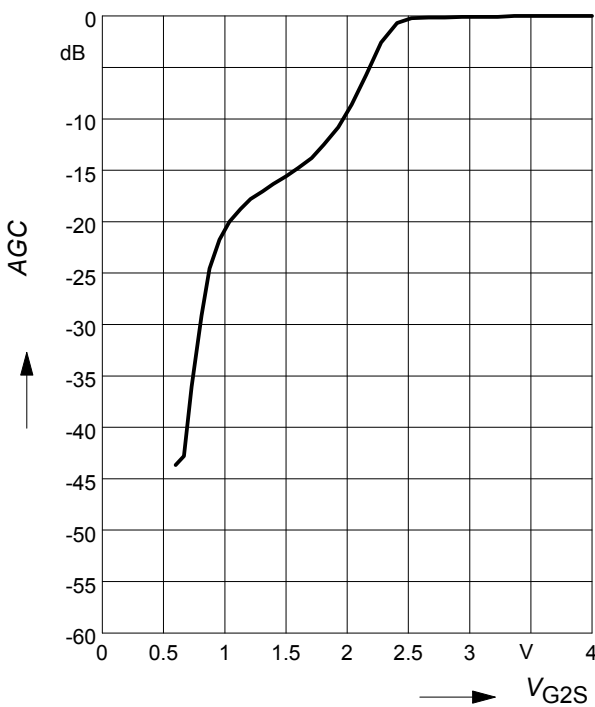

**AGC characteristic  $AGC = f(V_{G2S})$**

$f = 800 \text{ MHz, amp. B}$

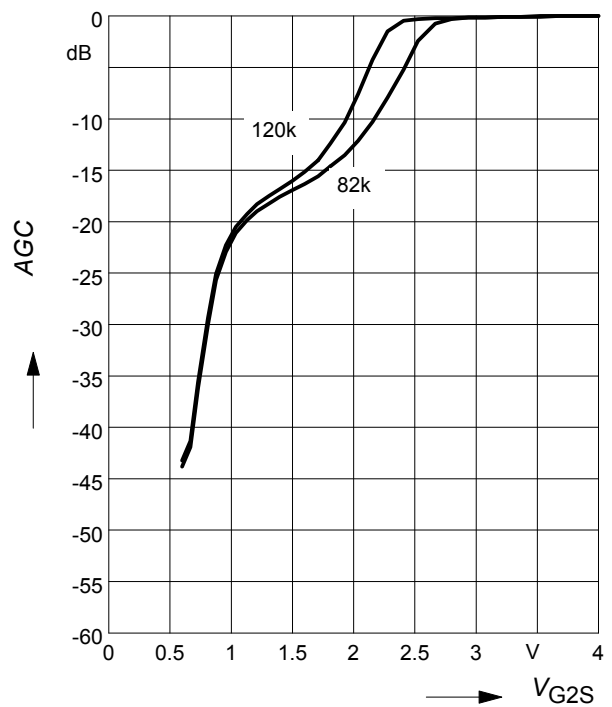

**Crossmodulation  $V_{unw} = (AGC)$**

$V_{DS} = 5\text{ V}$ ,  $R_{g1} = 120\text{ k}\Omega$

amp.A

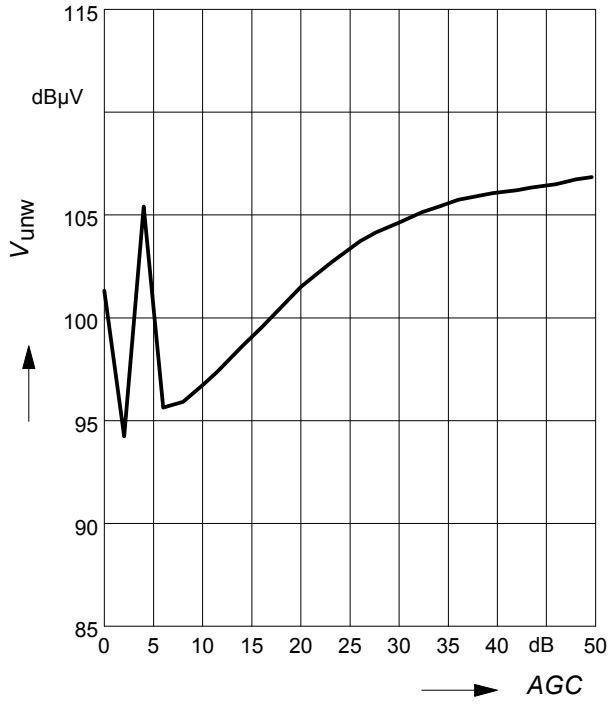

**Crossmodulation  $V_{unw} = (AGC)$**

$V_{DS} = 5\text{ V}$ ,  $R_{g1} = 56\text{ k}\Omega$

amp.B

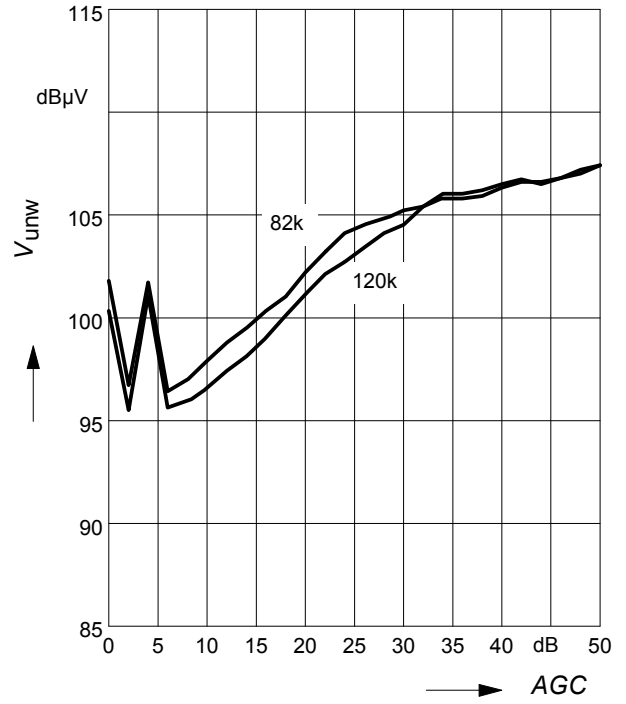

Crossmodulation test circuit

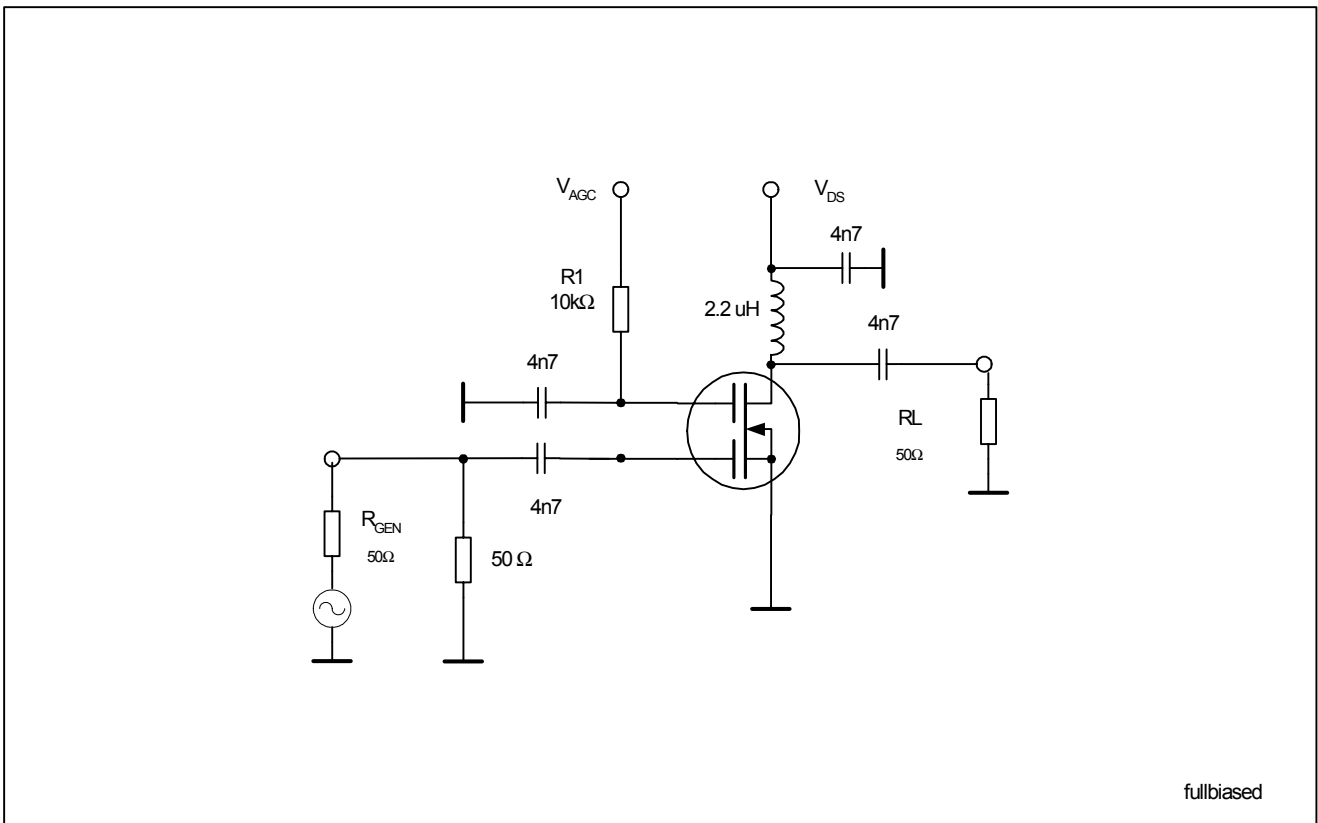
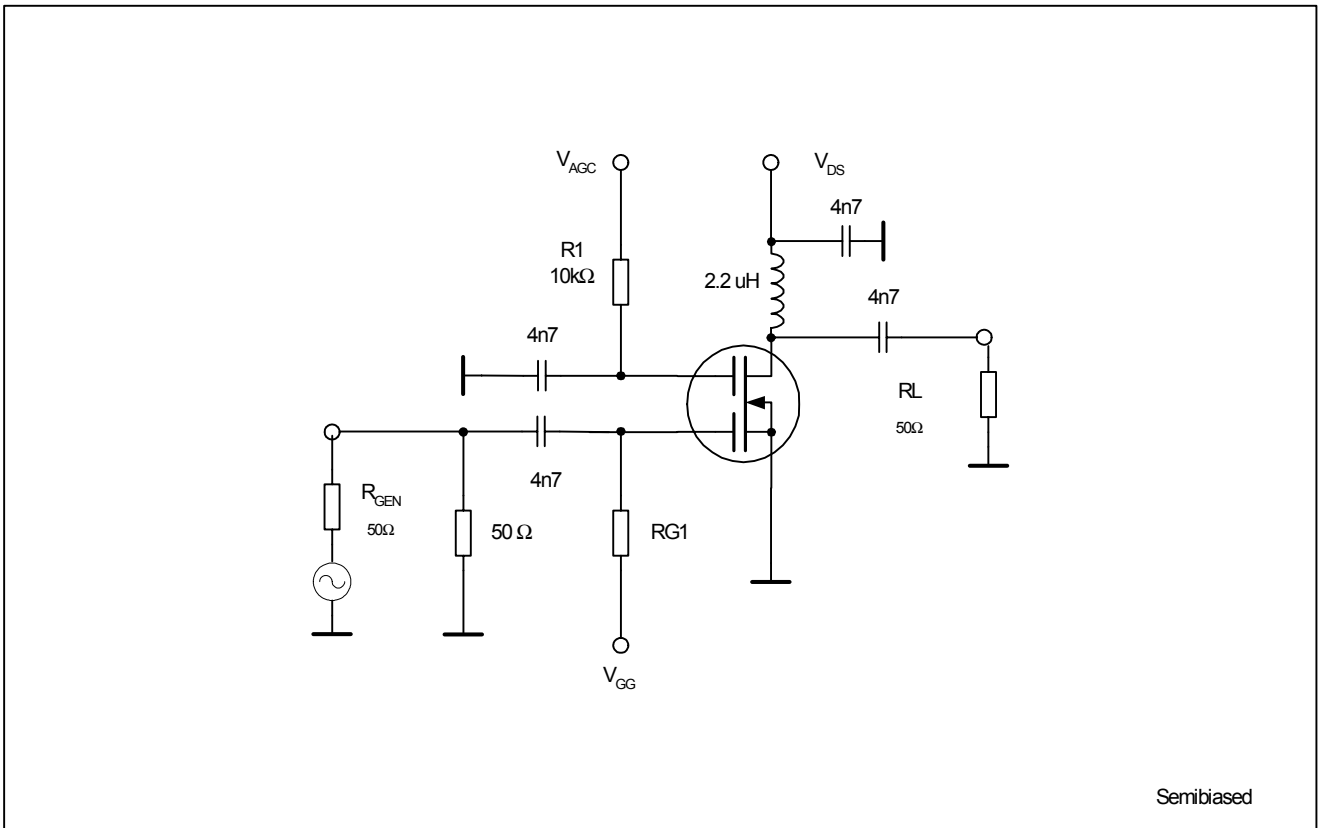

Package Outline

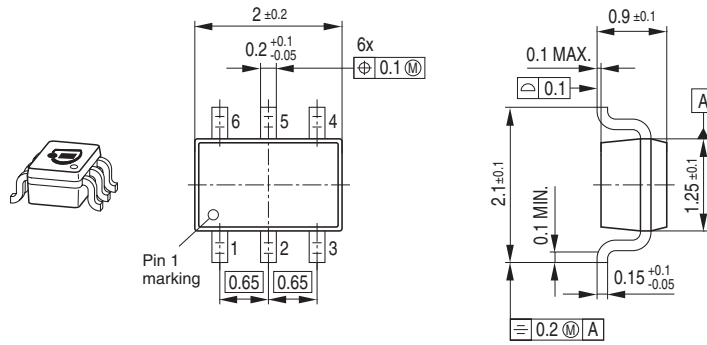

Foot Print

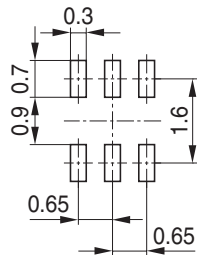

Marking Layout (Example)

Small variations in positioning of Date code, Type code and Manufacture are possible.

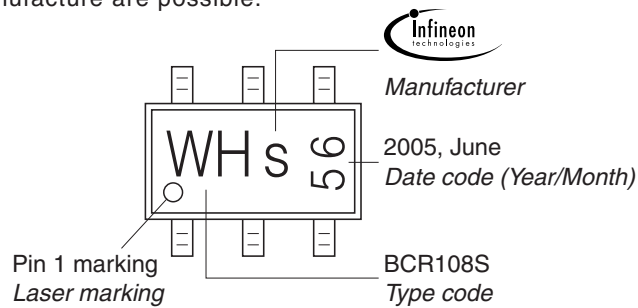

Standard Packing

Reel ø180 mm = 3.000 Pieces/Reel  
 Reel ø330 mm = 10.000 Pieces/Reel

For symmetric types no defined Pin 1 orientation in reel.

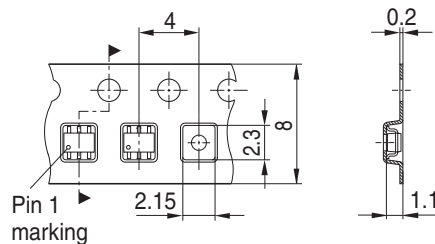

Edition 2006-02-01

Published by

Infineon Technologies AG

81726 München, Germany

© Infineon Technologies AG 2007.

All Rights Reserved.

### **Attention please!**

The information given in this dokument shall in no event be regarded as a guarantee of conditions or characteristics ("Beschaffenheitsgarantie"). With respect to any examples or hints given herein, any typical values stated herein and/or any information regarding the application of the device, Infineon Technologies hereby disclaims any and all warranties and liabilities of any kind, including without limitation warranties of non-infringement of intellectual property rights of any third party.

### **Information**

For further information on technology, delivery terms and conditions and prices please contact your nearest Infineon Technologies Office ([www.infineon.com](http://www.infineon.com)).

### **Warnings**



Due to technical requirements components may contain dangerous substances. For information on the types in question please contact your nearest Infineon Technologies Office.

Infineon Technologies Components may only be used in life-support devices or systems with the express written approval of Infineon Technologies, if a failure of such components can reasonably be expected to cause the failure of that life-support device or system, or to affect the safety or effectiveness of that device or system.

Life support devices or systems are intended to be implanted in the human body, or to support and/or maintain and sustain and/or protect human life. If they fail, it is reasonable to assume that the health of the user or other persons may be endangered.

## Looking for pricing, stock, or lifecycle information?

Click below to explore more details on WIN SOURCE:

-  [View BG5412KE6327HTSA1 on WIN SOURCE](#)
-  [Infineon Technologies Information](#)

## Optimize Your Supply Chain with WIN SOURCE Solutions

-  Global Sourcing Solution
-  Obsolete Management
-  Cost Control Management
-  Shortage Management
-  Alternative Solution
-  Excess Inventory Management