

# BGA2714

## MMIC wideband amplifier

Rev. 01 — 24 May 2007

Product data sheet

## 1. Product profile

### 1.1 General description

Silicon Monolithic Microwave Integrated Circuit (MMIC) wideband amplifier with internal matching circuit in a 6-pin SOT363 plastic SMD package.

**Table 1. Typical performance**

*T<sub>amb</sub> = 25 °C; measured on demo board; typical values.*

f (MHz)	V <sub>SUP</sub> (V)	I <sub>SUP</sub> (mA)	G <sub>p</sub> (dB)	NF (dB)	P <sub>L(1dB)</sub> (dBm)	P <sub>L(sat)</sub> (dBm)	IP3 <sub>O</sub> (dBm)
250	3.0	4.58	20.7	2.4	-7.8	-2.4	4.3
950	3.0	4.58	20.4	2.2	-7.9	-3.4	2.1
2150	3.0	4.58	20.8	3.0	-9.0	-4.7	0.0

#### CAUTION



This device is sensitive to ElectroStatic Discharge (ESD). Therefore care should be taken during transport and handling.

### 1.2 Features

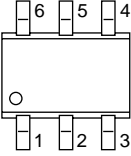
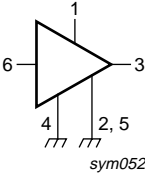
- Internally matched to 50 Ω
- Wide frequency range (2.7 GHz at 3 dB gain bandwidth)
- Flat 21 dB gain ( $\pm 1$  dB from DC up to 2500 MHz)
- Very low current (4.6 mA) at low supply voltage of 3 V
- Very good reverse isolation (> 50 dB up to 2 GHz)
- Good linearity with low second order and third order products
- Low noise (NF = 2.2 dB at 1 GHz)
- Unconditionally stable ( $K > 5$ )

### 1.3 Applications

- LNB IF amplifiers
- General purpose low noise wideband amplifier for frequencies between DC and 2.7 GHz

## 2. Pinning information

**Table 2. Pinning**

Pin	Description	Simplified outline	Symbol
1	V <sub>SUP</sub>		 sym052
2, 5	GND2		
3	RF_OUT		
4	GND1		
6	RF_IN		

## 3. Ordering information

**Table 3. Ordering information**

Type number	Package		
	Name	Description	Version
BGA2714	-	plastic surface-mounted package; 6 leads	SOT363

## 4. Marking

**Table 4. Marking**

Type number	Marking code
BGA2714	BA-

## 5. Limiting values

**Table 5. Limiting values**

*In accordance with the Absolute Maximum Rating System (IEC 60134).*

Symbol	Parameter	Conditions	Min	Max	Unit
V <sub>SUP</sub>	supply voltage	RF input AC coupled	-	4	V
I <sub>SUP</sub>	supply current		-	10	mA
P <sub>tot</sub>	total power dissipation	T <sub>sp</sub> = 90 °C	-	200	mW
T <sub>stg</sub>	storage temperature		-65	+150	°C
T <sub>j</sub>	junction temperature		-	150	°C
P <sub>drive</sub>	drive power		-	-20	dBm

## 6. Thermal characteristics

**Table 6. Thermal characteristics**

Symbol	Parameter	Conditions	Typ	Unit
$R_{th(j-sp)}$	thermal resistance from junction to solder point	$P_{tot} = 200 \text{ mW}; T_{sp} = 90 \text{ }^\circ\text{C}$	300	K/W

## 7. Characteristics

**Table 7. Characteristics**

$V_{SUP} = 3 \text{ V}; I_{SUP} = 4.58 \text{ mA}; T_{amb} = 25 \text{ }^\circ\text{C};$  measured on demo board; unless otherwise specified.

Symbol	Parameter	Conditions	Min	Typ	Max	Unit
$I_{SUP}$	supply current		3.7	4.58	5.7	mA
$G_p$	power gain	$f = 100 \text{ MHz}$	20	20.8	21	dB
		$f = 250 \text{ MHz}$	20	20.7	21	dB
		$f = 950 \text{ MHz}$	20	20.4	21	dB
		$f = 2150 \text{ MHz}$	20	20.8	22	dB
		$f = 2500 \text{ MHz}$	19	19.5	21	dB
		$f = 3000 \text{ MHz}$	16	16.8	18	dB
$RL_{in}$	input return loss	$f = 250 \text{ MHz}$	11	13.9	-	dB
		$f = 950 \text{ MHz}$	7	8.9	-	dB
		$f = 2150 \text{ MHz}$	12	15.9	-	dB
$RL_{out}$	output return loss	$f = 250 \text{ MHz}$	10	10.6	-	dB
		$f = 950 \text{ MHz}$	10	10.8	-	dB
		$f = 2150 \text{ MHz}$	8	9.8	-	dB
ISL	isolation	$f = 250 \text{ MHz}$	55	58	-	dB
		$f = 950 \text{ MHz}$	55	59	-	dB
		$f = 2150 \text{ MHz}$	45	49	-	dB
NF	noise figure	$f = 250 \text{ MHz}$	-	2.4	2.5	dB
		$f = 950 \text{ MHz}$	-	2.2	2.3	dB
		$f = 2150 \text{ MHz}$	-	3.0	3.2	dB
$B_{-3dB}$	-3 dB bandwidth	3 dB below gain at 1 GHz	-	2.7	-	GHz
K	Rollet stability factor	$f = 250 \text{ MHz}$	25	30	-	
		$f = 950 \text{ MHz}$	35	47	-	
		$f = 2150 \text{ MHz}$	7	10	-	
$P_{L(sat)}$	saturated output power	$f = 250 \text{ MHz}$	-3	-2.4	-	dBm
		$f = 950 \text{ MHz}$	-4	-3.4	-	dBm
		$f = 2150 \text{ MHz}$	-6	-4.7	-	dBm
$P_{L(1dB)}$	output power at 1 dB gain compression	$f = 250 \text{ MHz}$	-8.5	-7.8	-	dBm
		$f = 950 \text{ MHz}$	-8.7	-7.9	-	dBm
		$f = 2150 \text{ MHz}$	-10	-9	-	dBm

**Table 7. Characteristics ...continued**

$V_{SUP} = 3\text{ V}$ ;  $I_{SUP} = 4.58\text{ mA}$ ;  $T_{amb} = 25\text{ }^\circ\text{C}$ ; measured on demo board; unless otherwise specified.

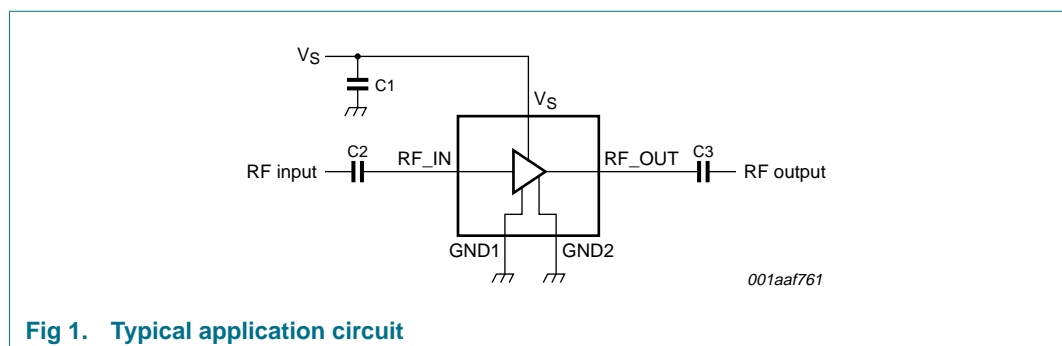
Symbol	Parameter	Conditions	Min	Typ	Max	Unit
IP3 <sub>I</sub>	input third-order intercept point	f = 250 MHz	-17.4	-16.4	-	dBm
		f = 950 MHz	-19.1	-18.3	-	dBm
		f = 2150 MHz	-21.8	-20.8	-	dBm
IP3 <sub>O</sub>	output third-order intercept point	f = 250 MHz	3.3	4.3	-	dBm
		f = 950 MHz	1.3	2.1	-	dBm
		f = 2150 MHz	-1.0	0	-	dBm
P <sub>L(2H)</sub>	second harmonic output power	f <sub>1H</sub> = 250 MHz; f <sub>2H</sub> = 500 MHz; P <sub>drive</sub> = -40 dBm	-62	-64	-	dBm
		f <sub>1H</sub> = 950 MHz; f <sub>2H</sub> = 1900 MHz; P <sub>drive</sub> = -40 dBm	-58	-60	-	dBm
ΔIM2	second-order intermodulation distance	f <sub>1</sub> = 250 MHz; f <sub>2</sub> = 251 MHz; P <sub>drive</sub> = -40 dBm	-36	-38	-	dBc
		f <sub>1</sub> = 950 MHz; f <sub>2</sub> = 951 MHz; P <sub>drive</sub> = -40 dBm	-31	-33	-	dBc

## 8. Application information

Figure 1 shows a typical application circuit for the BGA2714 MMIC. The device is internally matched to 50 Ω, and therefore does not need any external matching. The value of the input and output DC blocking capacitors C2 and C3 should not be more than 100 pF for applications above 100 MHz. However, when the device is operated below 100 MHz, the capacitor value should be increased.

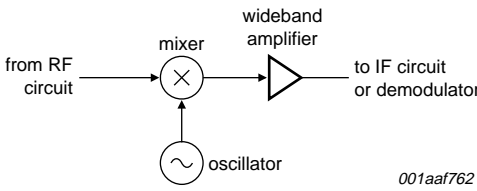
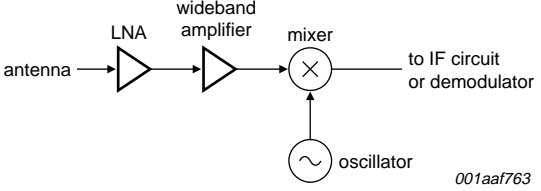
The 22 nF supply decoupling capacitor C1 should be located as close as possible to the MMIC.

The PCB top ground plane, connected to pins 2, 4 and 5 must be as close as possible to the MMIC, preferably also below the MMIC. When using via holes, use multiple via holes as close as possible to the MMIC.

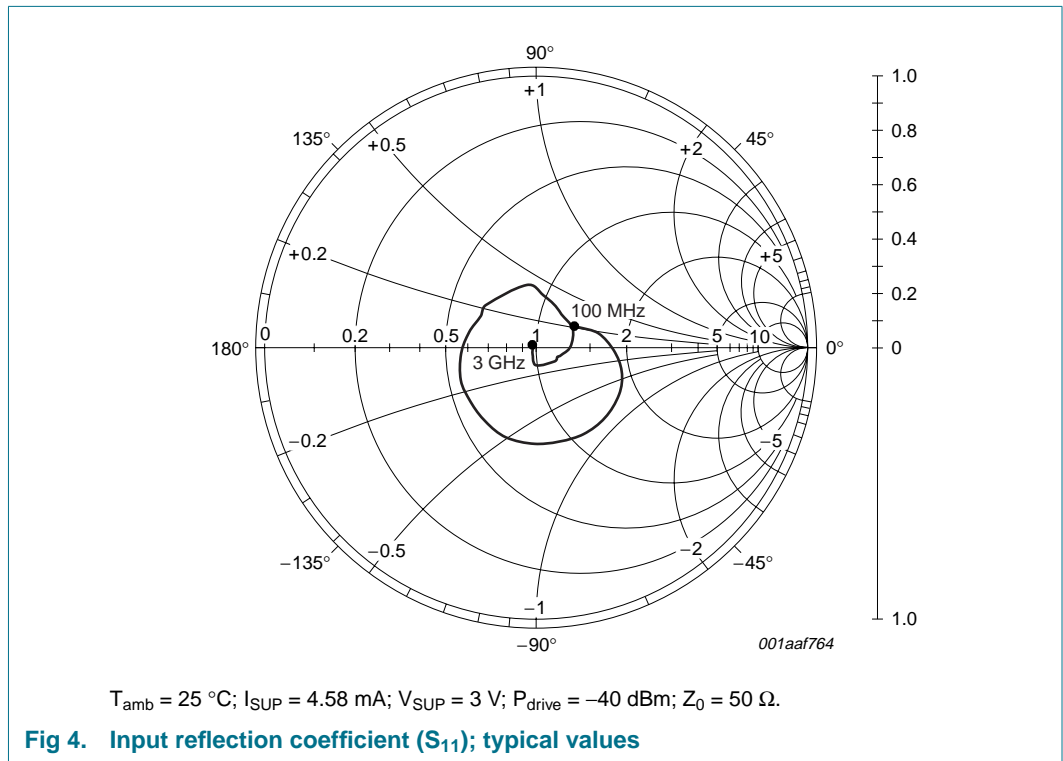


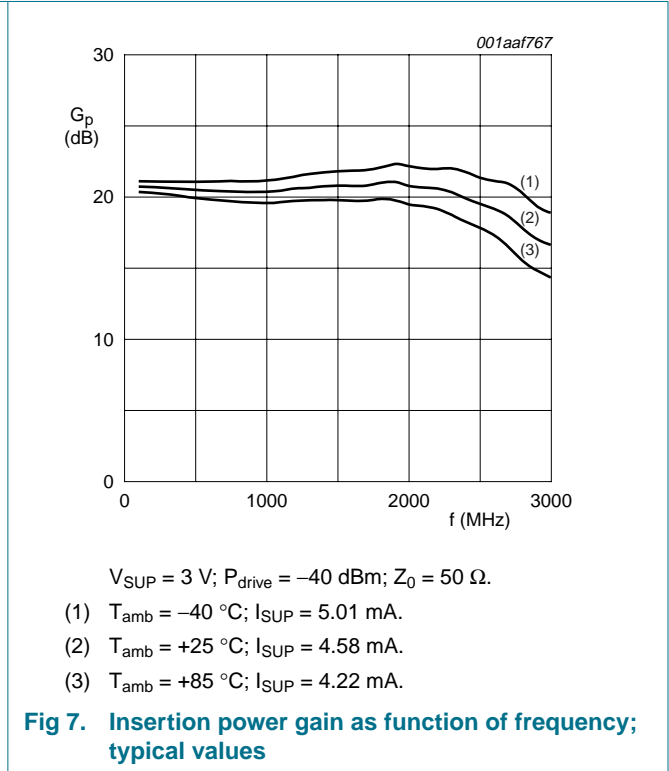
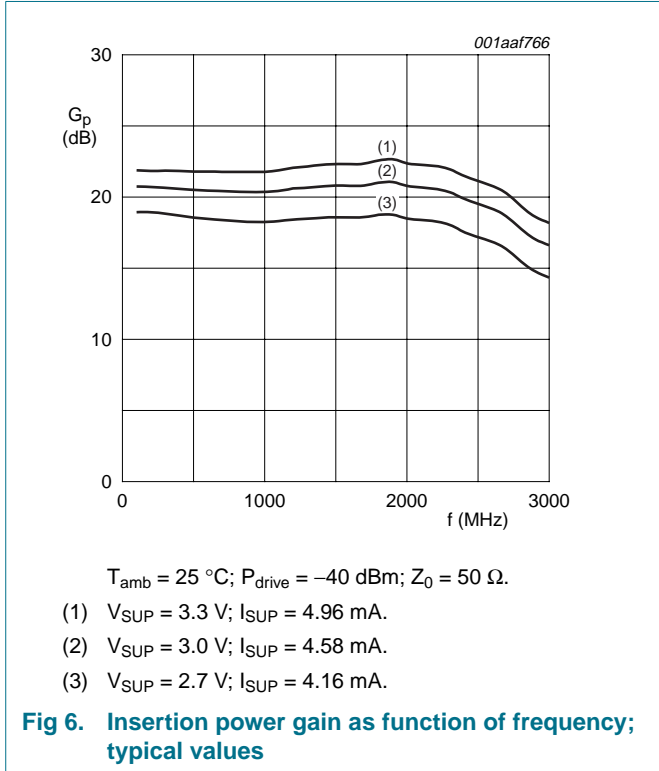
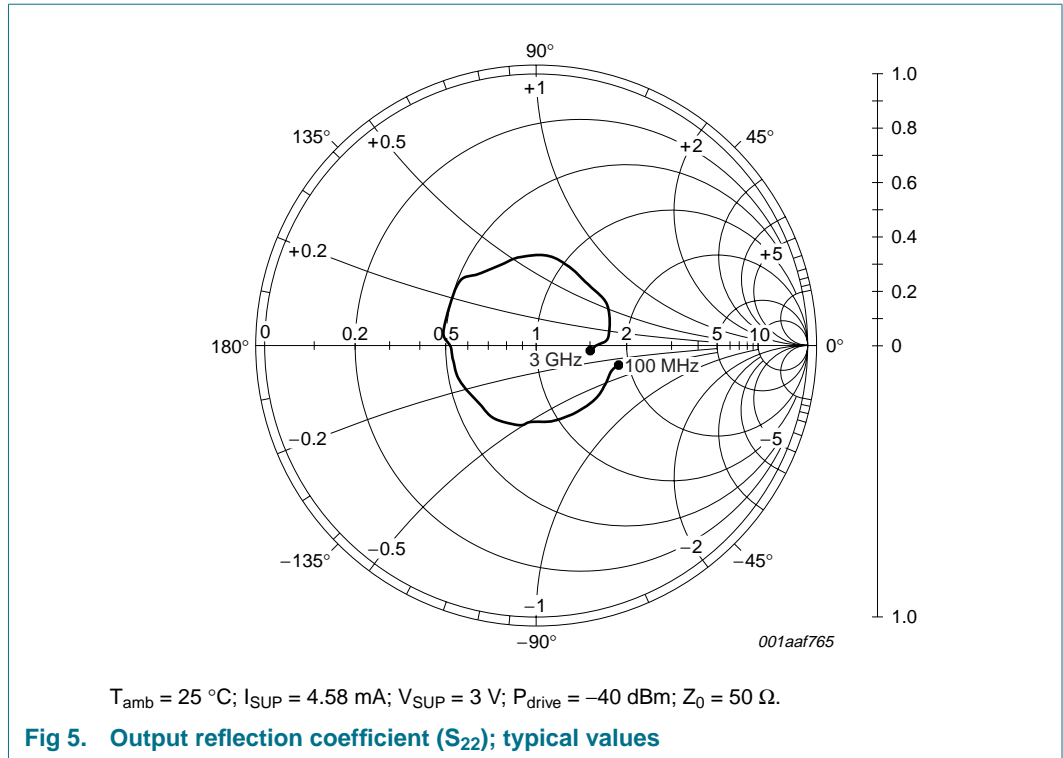
**Fig 1. Typical application circuit**

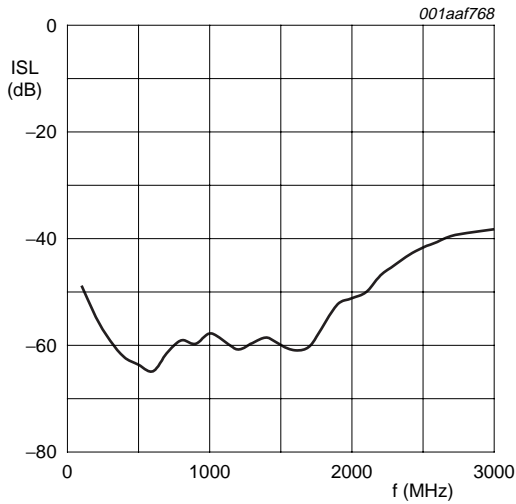
**8.1 Application examples**

 <p>The MMIC is very suitable as IF amplifier in e.g. LNB's. The excellent wideband characteristics make it an easy building block.</p>	 <p>As second amplifier after an LNA, the MMIC offers an easy matching, low noise solution.</p>
<b>Fig 2. Application as IF amplifier</b>	<b>Fig 3. Application as RF amplifier</b>

**8.2 Graphs**

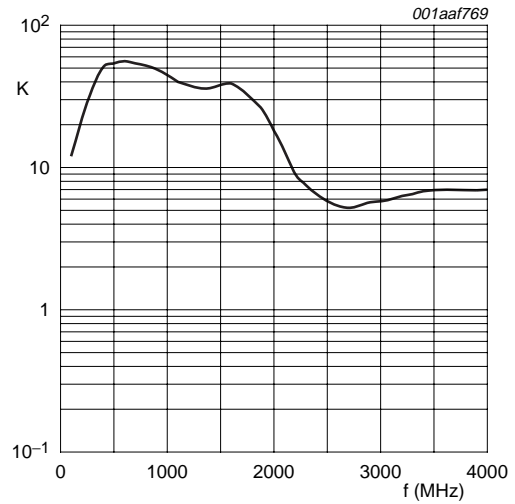






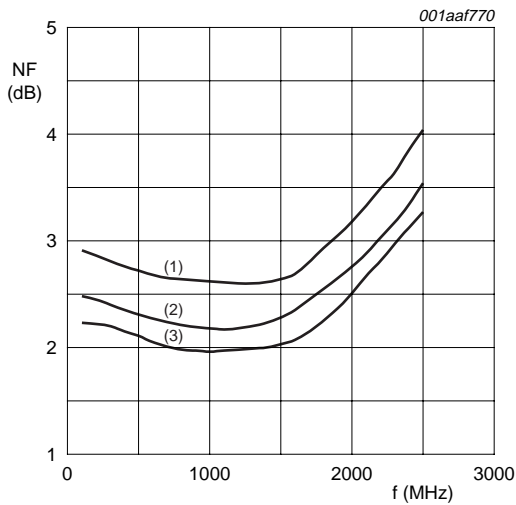
$T_{amb} = 25\text{ }^{\circ}\text{C}$ ;  $I_{SUP} = 4.58\text{ mA}$ ;  $V_{SUP} = 3\text{ V}$ ;  
 $P_{drive} = -40\text{ dBm}$ ;  $Z_0 = 50\text{ }\Omega$ .

**Fig 8. Isolation as function of frequency; typical values**



$T_{amb} = 25\text{ }^{\circ}\text{C}$ ;  $I_{SUP} = 4.58\text{ mA}$ ;  $V_{SUP} = 3\text{ V}$ ;  
 $Z_0 = 50\text{ }\Omega$ .

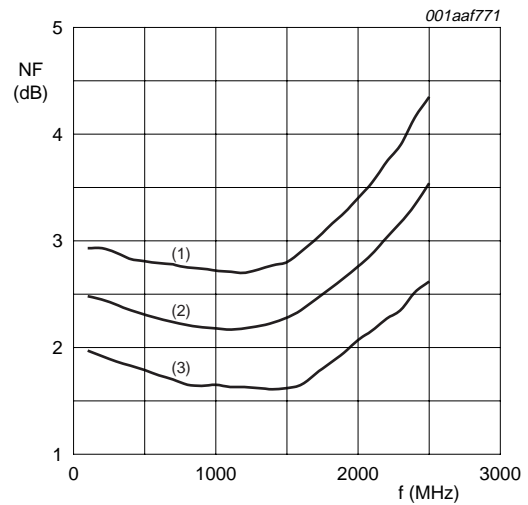
**Fig 9. Rollet stability factor as function of frequency; typical values**



$T_{amb} = 25\text{ }^{\circ}\text{C}$ ;  $Z_0 = 50\text{ }\Omega$ .

- (1)  $V_{SUP} = 3.3\text{ V}$ ;  $I_{SUP} = 4.96\text{ mA}$ .
- (2)  $V_{SUP} = 3.0\text{ V}$ ;  $I_{SUP} = 4.58\text{ mA}$ .
- (3)  $V_{SUP} = 2.7\text{ V}$ ;  $I_{SUP} = 4.16\text{ mA}$ .

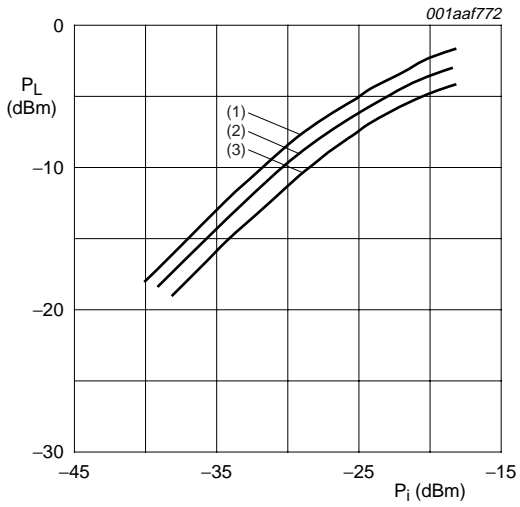
**Fig 10. Noise figure as function of frequency**



$V_{SUP} = 3\text{ V}$ ;  $Z_0 = 50\text{ }\Omega$ .

- (1)  $T_{amb} = -40\text{ }^{\circ}\text{C}$ ;  $I_{SUP} = 5.01\text{ mA}$ .
- (2)  $T_{amb} = +25\text{ }^{\circ}\text{C}$ ;  $I_{SUP} = 4.58\text{ mA}$ .
- (3)  $T_{amb} = +85\text{ }^{\circ}\text{C}$ ;  $I_{SUP} = 4.22\text{ mA}$ .

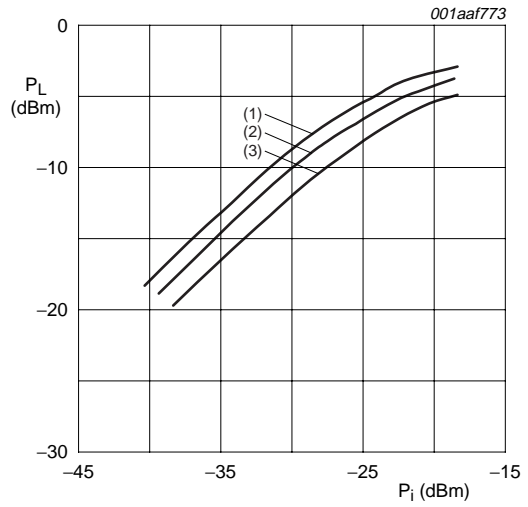
**Fig 11. Noise figure as function of frequency**



$T_{amb} = 25\text{ }^{\circ}\text{C}$ ;  $f = 250\text{ MHz}$ ;  $Z_0 = 50\text{ }\Omega$ .

- (1)  $V_{SUP} = 3.3\text{ V}$ .
- (2)  $V_{SUP} = 3.0\text{ V}$ .
- (3)  $V_{SUP} = 2.7\text{ V}$ .

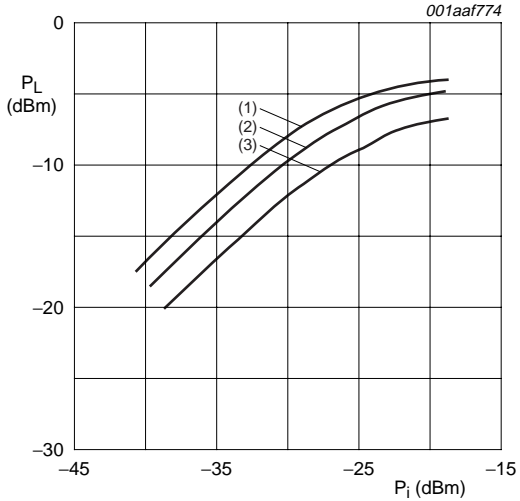
**Fig 12. Output power as function of input power at 250 MHz; typical values**



$T_{amb} = 25\text{ }^{\circ}\text{C}$ ;  $f = 950\text{ MHz}$ ;  $Z_0 = 50\text{ }\Omega$ .

- (1)  $V_{SUP} = 3.3\text{ V}$ .
- (2)  $V_{SUP} = 3.0\text{ V}$ .
- (3)  $V_{SUP} = 2.7\text{ V}$ .

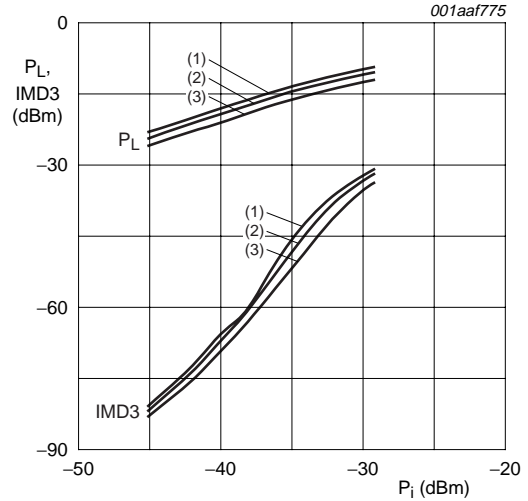
**Fig 13. Output power as function of input power at 950 MHz; typical values**



$T_{amb} = 25\text{ }^{\circ}\text{C}$ ;  $f = 2150\text{ MHz}$ ;  $Z_0 = 50\text{ }\Omega$ .

- (1)  $V_{SUP} = 3.3\text{ V}$ .
- (2)  $V_{SUP} = 3.0\text{ V}$ .
- (3)  $V_{SUP} = 2.7\text{ V}$ .

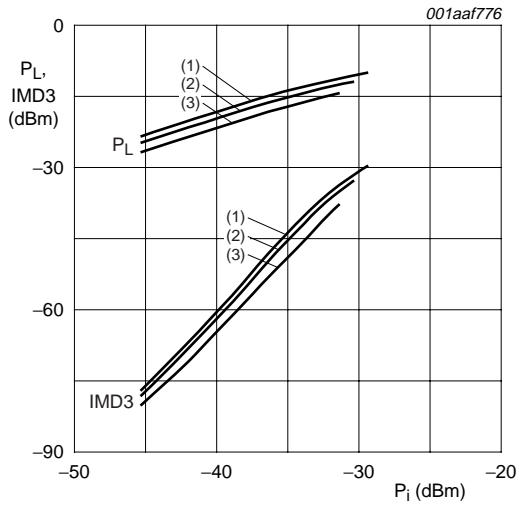
**Fig 14. Output power as function of input power at 2150 MHz; typical values**



$T_{amb} = 25\text{ }^{\circ}\text{C}$ ;  $f_1 = 250\text{ MHz}$ ;  $f_2 = 251\text{ MHz}$ ;  $Z_0 = 50\text{ }\Omega$ .

- (1)  $V_{SUP} = 3.3\text{ V}$ .
- (2)  $V_{SUP} = 3.0\text{ V}$ .
- (3)  $V_{SUP} = 2.7\text{ V}$ .

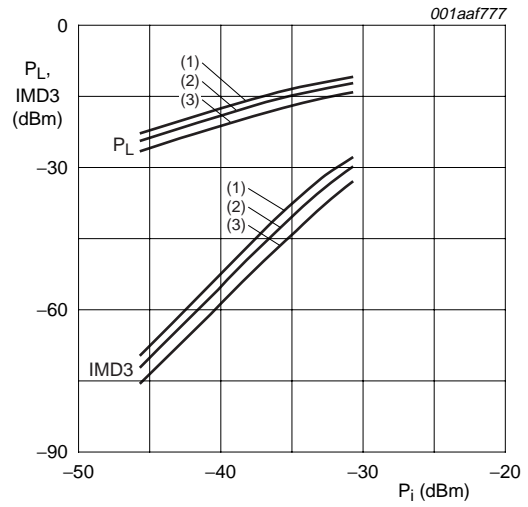
**Fig 15. Output power and third order intermodulation as functions of input power around 250 MHz; typical values**



$T_{amb} = 25\text{ }^{\circ}\text{C}$ ;  $f_1 = 950\text{ MHz}$ ;  $f_2 = 951\text{ MHz}$ ;  
 $Z_0 = 50\text{ }\Omega$ .

- (1)  $V_{SUP} = 3.3\text{ V}$ .
- (2)  $V_{SUP} = 3.0\text{ V}$ .
- (3)  $V_{SUP} = 2.7\text{ V}$ .

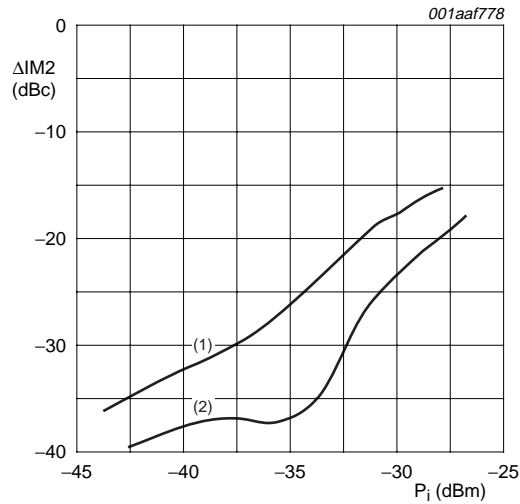
**Fig 16. Output power and third order intermodulation as functions of input power around 950 MHz; typical values**



$T_{amb} = 25\text{ }^{\circ}\text{C}$ ;  $f_1 = 2150\text{ MHz}$ ;  $f_2 = 2151\text{ MHz}$ ;  
 $Z_0 = 50\text{ }\Omega$ .

- (1)  $V_{SUP} = 3.3\text{ V}$ .
- (2)  $V_{SUP} = 3.0\text{ V}$ .
- (3)  $V_{SUP} = 2.7\text{ V}$ .

**Fig 17. Output power and third order intermodulation as functions of input power around 2150 MHz; typical values**



$T_{amb} = 25\text{ }^{\circ}\text{C}$ ;  $I_{SUP} = 4.58\text{ mA}$ ;  $V_{SUP} = 3\text{ V}$ ;  $Z_0 = 50\text{ }\Omega$ .

- (1)  $f_1 = 950\text{ MHz}$ ;  $f_2 = 951\text{ MHz}$ .
- (2)  $f_1 = 250\text{ MHz}$ ;  $f_2 = 251\text{ MHz}$ .

**Fig 18. Second-order intermodulation distance as function of input power; typical values**

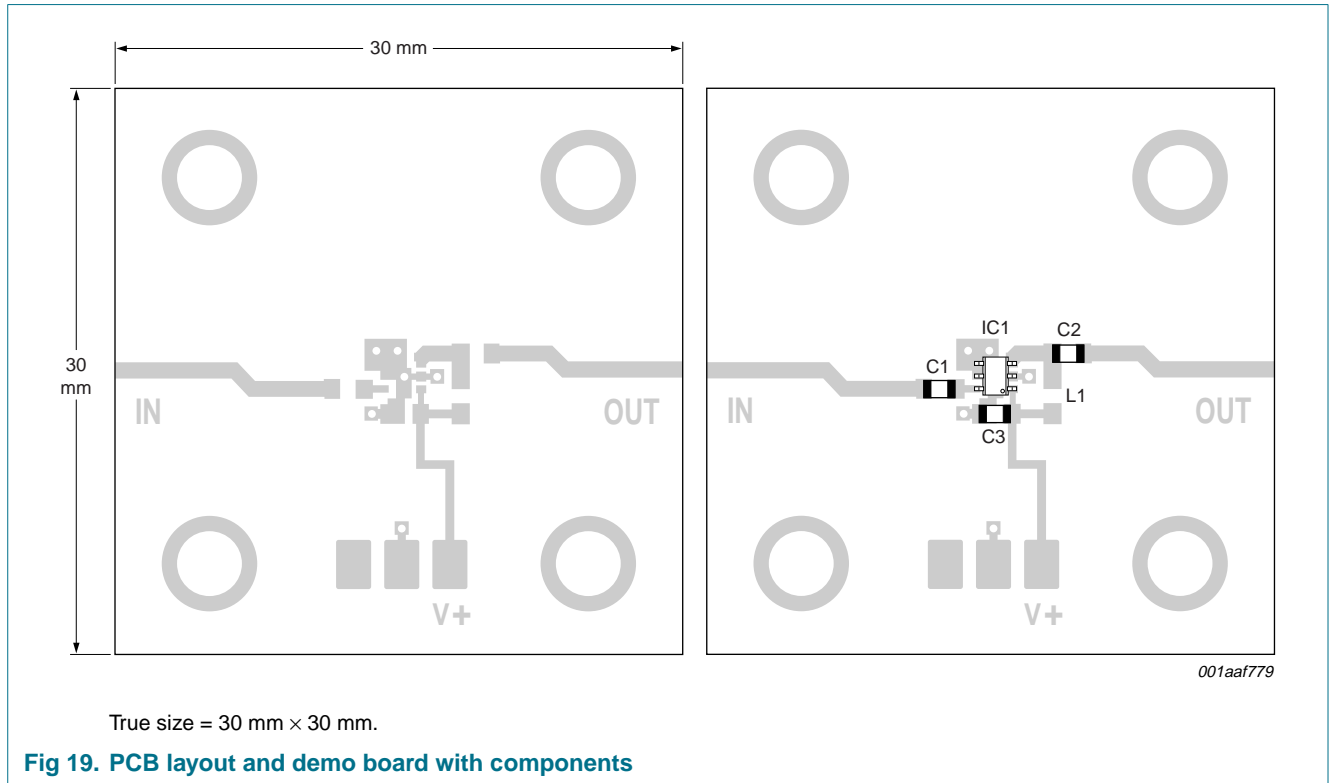
### 8.3 Scattering parameters

**Table 8. Scattering parameters**

$I_{SUP} = 4.58 \text{ mA}$ ;  $V_{SUP} = 3 \text{ V}$ ;  $P_{drive} = -40 \text{ dBm}$ ;  $Z_0 = 50 \Omega$ ;  $T_{amb} = 25 \text{ }^\circ\text{C}$ ; measured on demo board.

f (MHz)	S <sub>11</sub>		S <sub>21</sub>		S <sub>12</sub>		S <sub>22</sub>		K
	Magnitude (ratio)	Angle (deg)	Magnitude (ratio)	Angle (deg)	Magnitude (ratio)	Angle (deg)	Magnitude (ratio)	Angle (deg)	
100	0.155	33.5	10.88	-10.9	0.00364	-155.2	0.313	-14.2	11.2
200	0.170	26.5	10.84	-20.2	0.00183	-21.9	0.294	-19.2	22.3
400	0.280	-2.2	10.69	-43.8	0.00077	-25.5	0.396	-36.4	50.7
600	0.346	-30.4	10.54	-64.1	0.00057	122.0	0.293	-54.9	66.9
800	0.365	-62.7	10.46	-85.9	0.00111	115.1	0.291	-74.4	11.2
1000	0.360	-91.4	10.42	-106.3	0.00129	80.2	0.289	-94.8	29.7
1200	0.335	-124.9	10.72	-127.4	0.00091	-54.8	0.315	-119.5	40.7
1400	0.305	-156.3	10.90	-148.7	0.00118	-55.9	0.304	-140.2	31.9
1600	0.255	167.0	10.94	-172.9	0.00090	157.0	0.310	-167.3	43.0
1800	0.246	139.2	11.22	166.3	0.00155	7.1	0.343	172.3	23.9
2000	0.197	83.5	10.95	140.2	0.00276	133.2	0.335	129.3	14.1
2200	0.153	54.8	10.71	115.3	0.00453	63.4	0.327	101.6	9.0
2400	0.121	1.7	9.87	87.3	0.00700	31.8	0.310	66.2	6.5
2600	0.081	-24.9	9.09	63.3	0.00933	51.9	0.293	45.0	5.4
2800	0.066	-93.6	7.74	36.6	0.01119	24.8	0.266	5.8	5.4
3000	0.019	144.4	6.77	20.5	0.01228	14.1	0.203	-6.6	5.8

**9. Test information**



**Fig 19. PCB layout and demo board with components**

**Table 9. List of components used for the typical application**

Component	Description	Value	Dimensions
C1, C2	multilayer ceramic chip capacitor	100 pF	0603
C3	multilayer ceramic chip capacitor	22 nF	0603
IC1	BGA2714 MMIC		SOT363
L1	not used		

**10. Package outline**

Plastic surface-mounted package; 6 leads

SOT363

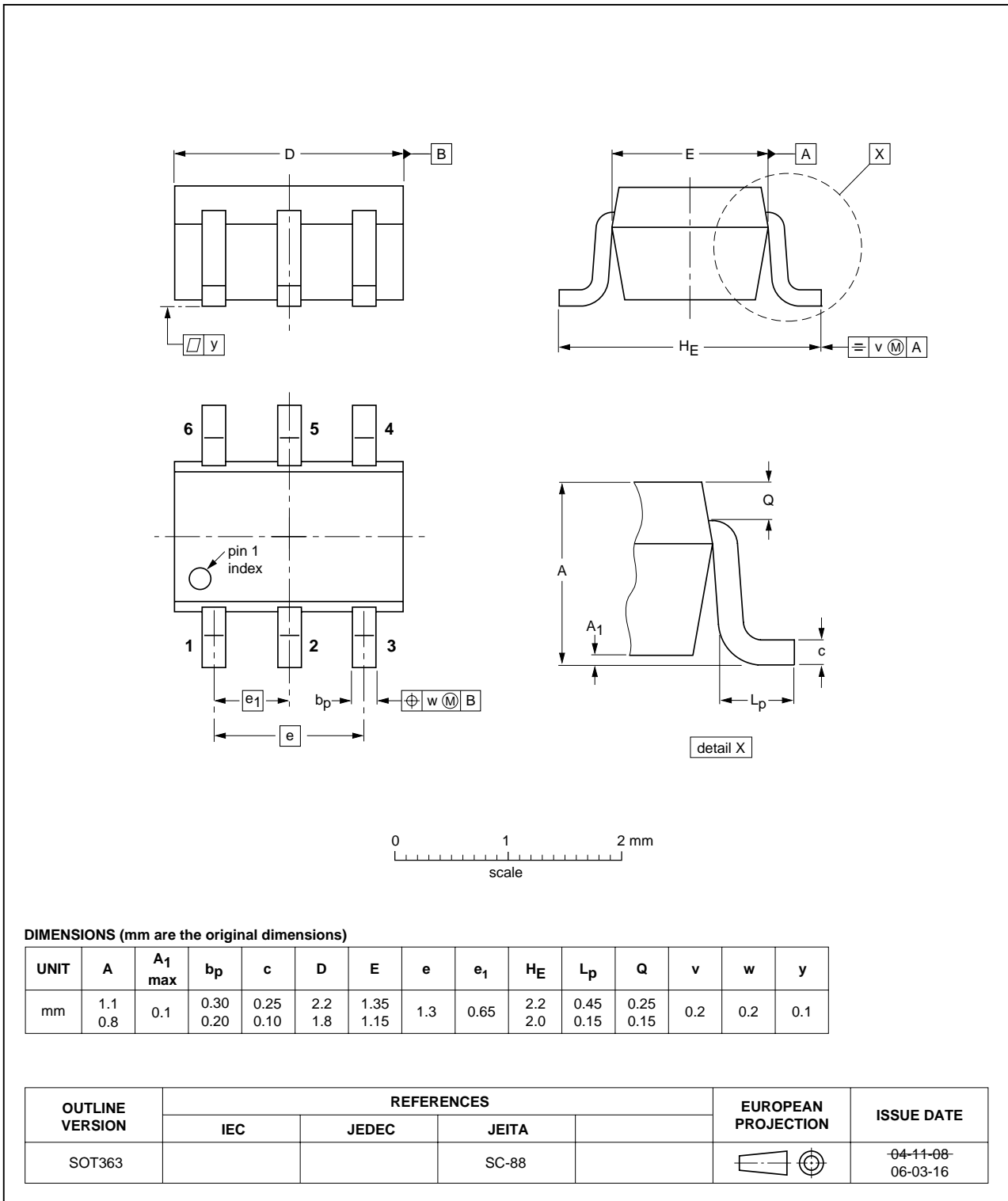


Fig 20. Package outline SOT363

## 11. Abbreviations

**Table 10. Abbreviations**

Acronym	Description
DC	Direct Current
IF	Intermediate Frequency
LNA	Low-Noise Amplifier
LNB	Low-Noise Block converter
PCB	Printed-Circuit Board
RF	Radio Frequency

## 12. Revision history

**Table 11. Revision history**

Document ID	Release date	Data sheet status	Change notice	Supersedes
BGA2714_1	20070524	Product data sheet	-	-

## 13. Legal information

### 13.1 Data sheet status

Document status <sup>[1][2]</sup>	Product status <sup>[3]</sup>	Definition
Objective [short] data sheet	Development	This document contains data from the objective specification for product development.
Preliminary [short] data sheet	Qualification	This document contains data from the preliminary specification.
Product [short] data sheet	Production	This document contains the product specification.

[1] Please consult the most recently issued document before initiating or completing a design.

[2] The term 'short data sheet' is explained in section "Definitions".

[3] The product status of device(s) described in this document may have changed since this document was published and may differ in case of multiple devices. The latest product status information is available on the Internet at URL <http://www.nxp.com>.

### 13.2 Definitions

**Draft** — The document is a draft version only. The content is still under internal review and subject to formal approval, which may result in modifications or additions. NXP Semiconductors does not give any representations or warranties as to the accuracy or completeness of information included herein and shall have no liability for the consequences of use of such information.

**Short data sheet** — A short data sheet is an extract from a full data sheet with the same product type number(s) and title. A short data sheet is intended for quick reference only and should not be relied upon to contain detailed and full information. For detailed and full information see the relevant full data sheet, which is available on request via the local NXP Semiconductors sales office. In case of any inconsistency or conflict with the short data sheet, the full data sheet shall prevail.

### 13.3 Disclaimers

**General** — Information in this document is believed to be accurate and reliable. However, NXP Semiconductors does not give any representations or warranties, expressed or implied, as to the accuracy or completeness of such information and shall have no liability for the consequences of use of such information.

**Right to make changes** — NXP Semiconductors reserves the right to make changes to information published in this document, including without limitation specifications and product descriptions, at any time and without notice. This document supersedes and replaces all information supplied prior to the publication hereof.

**Suitability for use** — NXP Semiconductors products are not designed, authorized or warranted to be suitable for use in medical, military, aircraft, space or life support equipment, nor in applications where failure or

malfunction of a NXP Semiconductors product can reasonably be expected to result in personal injury, death or severe property or environmental damage. NXP Semiconductors accepts no liability for inclusion and/or use of NXP Semiconductors products in such equipment or applications and therefore such inclusion and/or use is at the customer's own risk.

**Applications** — Applications that are described herein for any of these products are for illustrative purposes only. NXP Semiconductors makes no representation or warranty that such applications will be suitable for the specified use without further testing or modification.

**Limiting values** — Stress above one or more limiting values (as defined in the Absolute Maximum Ratings System of IEC 60134) may cause permanent damage to the device. Limiting values are stress ratings only and operation of the device at these or any other conditions above those given in the Characteristics sections of this document is not implied. Exposure to limiting values for extended periods may affect device reliability.

**Terms and conditions of sale** — NXP Semiconductors products are sold subject to the general terms and conditions of commercial sale, as published at <http://www.nxp.com/profile/terms>, including those pertaining to warranty, intellectual property rights infringement and limitation of liability, unless explicitly otherwise agreed to in writing by NXP Semiconductors. In case of any inconsistency or conflict between information in this document and such terms and conditions, the latter will prevail.

**No offer to sell or license** — Nothing in this document may be interpreted or construed as an offer to sell products that is open for acceptance or the grant, conveyance or implication of any license under any copyrights, patents or other industrial or intellectual property rights.

### 13.4 Trademarks

Notice: All referenced brands, product names, service names and trademarks are the property of their respective owners.

## 14. Contact information

For additional information, please visit: <http://www.nxp.com>

For sales office addresses, send an email to: [salesaddresses@nxp.com](mailto:salesaddresses@nxp.com)

**15. Contents**

**1 Product profile . . . . . 1**

1.1 General description . . . . . 1

1.2 Features . . . . . 1

1.3 Applications . . . . . 1

**2 Pinning information . . . . . 2**

**3 Ordering information . . . . . 2**

**4 Marking . . . . . 2**

**5 Limiting values . . . . . 2**

**6 Thermal characteristics . . . . . 3**

**7 Characteristics . . . . . 3**

**8 Application information . . . . . 4**

8.1 Application examples . . . . . 5

8.2 Graphs . . . . . 5

8.3 Scattering parameters . . . . . 10

**9 Test information . . . . . 11**

**10 Package outline . . . . . 12**

**11 Abbreviations . . . . . 13**

**12 Revision history . . . . . 13**

**13 Legal information . . . . . 14**

13.1 Data sheet status . . . . . 14

13.2 Definitions . . . . . 14

13.3 Disclaimers . . . . . 14

13.4 Trademarks . . . . . 14

**14 Contact information . . . . . 14**

**15 Contents . . . . . 15**

Please be aware that important notices concerning this document and the product(s) described herein, have been included in section 'Legal information'.



© NXP B.V. 2007.

All rights reserved.

For more information, please visit: <http://www.nxp.com>



For sales office addresses, please send an email to: [salesaddresses@nxp.com](mailto:salesaddresses@nxp.com)

Date of release: 24 May 2007

Document identifier: BGA2714\_1

## Looking for pricing, stock, or lifecycle information?

Click below to explore more details on WIN SOURCE:

-  [View BGA2714 on WIN SOURCE](#)
-  [NXP / Nexperia Information](#)

## Optimize Your Supply Chain with WIN SOURCE Solutions

-  Global Sourcing Solution
-  Obsolete Management
-  Cost Control Management
-  Shortage Management
-  Alternative Solution
-  Excess Inventory Management