

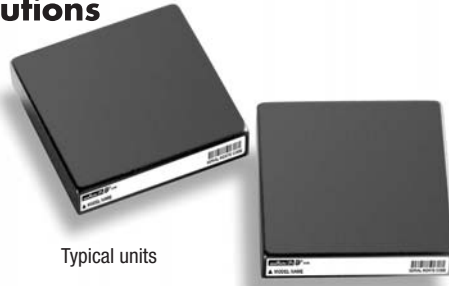



**THE DATASHEET OF
UWR-12/1650-D48A-C**





Typical units

FEATURES

- Low cost! Highly reliable!
- Proven SMT-on-pcb construction
- Designed to meet UL/ EN60950, BASIC insulation (D48A models)
-  mark available (48VIN models)
- Output voltages: 3.3/5/5.2/12/15 Volts
- Ultra-wide input voltage ranges: 4.7-7.5V, 9-36V or 18-75V
- Small packages, 2" x 2" x 0.45"
- Industry-standard pinouts
- Fully isolated, 1500Vdc guaranteed
- Guaranteed efficiencies to 84%
- -40 to +100°C operating temperature
- Modifications and customs for OEM's

PRODUCT OVERVIEW

Murata Power Solutions' new A-Series switching DC/DC converters are designed to meet the demanding long-term-reliability and low-cost requirements of modern telecom, datacom, computer/networking and industrial-electronics applications. These highly-efficient, rugged devices combine straightforward circuit topologies, new components, proven SMT-on-pcb construction methods, and highly repeatable automatic-assembly techniques. The flexibility of the designs and their assembly methods readily permit minor modifications to optimize performance for specific applications.

The single-output, 14-20 Watt Models of the A-Series deliver both high power densities and impressive MTBF's.

Packaged in standard, 2" x 2" x 0.45", shielded metal cases with non-conductive coatings, these fully isolated (1500Vdc minimum) DC/DC's offer excellent line/load regulation, full I/O protection, thermal shutdown, and industry-standard pinouts.

Output voltages include 3.3, 5, 5.2, 12 or 15 Volts. Input voltage ranges are Murata Power Solutions' traditional ultra-wide 9-36V and 18-75V, as well as 4.7-7.5V. Each device provides remote on/off control and V_{out} trim capability. All A-Series UWR models are fully EMI characterized and designed to meet UL1950, CSA 950 and IEC 950 safety.

A-Series DC/DC's are extremely reliable, easy-to-use, cost-effective power converters. Use them to improve the reliability of existing equipment or to develop new systems that exceed design objectives.

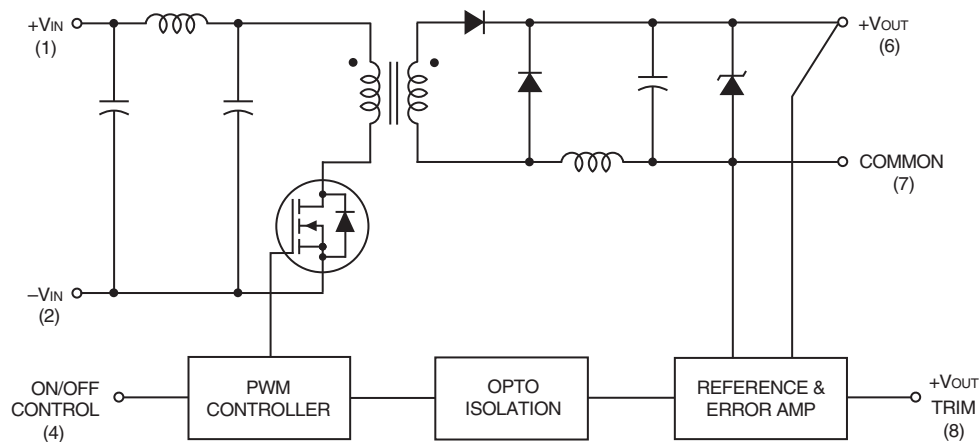

Figure 1. Simplified Schematic

Typical topology is shown.



Performance Specifications and Ordering Guide ①

Root Model ⑥	V _{OUT} (Volts)	I _{OUT} (mA)	Output		Regulation (Max.)		Input			Efficiency		Package (Case, Pinout)
			R/N (mVp-p) ②		Line		V _{IN} Nom. (Volts)	Range (Volts)	I _{IN} ④ (mA)	Min.	Typ.	
			Typ.	Max.	Line	Load ③						
Discontinued UWR-3.3/4250-D5A-C	3.3	4250	50	100	±1.0%	±1.0%	5	4.7-7.5	80/3720	76%	77%	C4, P6
Discontinued UWR-3.3/4850-D12A-C	3.3	4850	50	75	±0.5%	±1.0%	24	9-36	35/852	77%	79%	C4, P6
Discontinued UWR-3.3/4850-D48A-C	3.3	4850	50	100	±1.0%	±1.0%	48	18-75	15/425	77.5%	78.5%	C4, P6
Discontinued UWR-5/3000-D5A-C	5	3000	50	100	±1.0%	±1.0%	5	4.7-7.5	80/3800	78%	79%	C4, P6
Available UWR-5/4000-D12A-C	5	4000	50	100	±0.3%	±0.5%	24	9-36	15/1020	81%	82%	C4, P6
Available UWR-5/4000-D48A-C	5	4000	50	100	±0.3%	±0.5%	48	18-75	15/496	82%	84%	C4, P6
Discontinued UWR-5/4000-D48E-C ⑤	5	4000	50	100	±0.3%	±0.5%	48	36-72	15/484	84%	86%	C4, P6
Discontinued UWR-5.2/3000-D5A-C	5.2	3000	50	100	±1.0%	±1.0%	5	4.7-7.5	80/3900	79%	80%	C4, P6
Discontinued UWR-12/1250-D5A-C	12	1250	75	120	±1.0%	±1.0%	5	4.7-7.5	80/3660	80%	82%	C4, P6
Available UWR-12/1650-D12A-C	12	1650	50	100	±0.3%	±0.5%	24	9-36	15/982	82%	84%	C4, P6
Discontinued UWR-12/1650-D48A-C	12	1650	75	100	±0.3%	±0.5%	48	18-75	15/491	84%	85%	C4, P6
Discontinued UWR-15/1000-D5A-C	15	1000	75	150	±1.0%	±1.0%	5	4.7-7.5	80/3660	80%	82%	C4, P6
Discontinued UWR-15/1300-D12A-C	15	1300	50	100	±0.3%	±0.5%	24	9-36	20/967	84%	85%	C4, P6
Available UWR-15/1300-D48A-C	15	1300	75	100	±0.3%	±0.5%	48	18-75	10/484	84%	86%	C4, P6

① Typical at T_A = +25°C under nominal line voltage and full-load conditions unless otherwise noted.

② Ripple/Noise (R/N) measured over a 20MHz bandwidth.

③ 10% to 100% load.

④ Nominal line voltage, no-load/full-load conditions.

⑤ See Technical Notes for an explanation of trading off input voltage ranges for higher full-power operating temperature.

⑥ These are not complete part numbers. Please see the Part Number Structure.

Part Number Structure

U | WR - 5 / 4000 - D12 | A - C

Output Configuration:
U = Unipolar

Wide Range Input

Nominal Output Voltage:
3.3, 5, 12 or 15 Volts

Maximum Output Current
in mA

RoHS-6 hazardous substance compliant*

A-Series
High Reliability

Input Voltage Range:
D5 = 4.7-7.5 Volts (5V nominal)
D12 = 9-36 Volts (24V nominal)
D48 = 18-75/36-72 Volts (48V nominal)

* Contact Murata Power Solutions for availability.

Temperature Derating

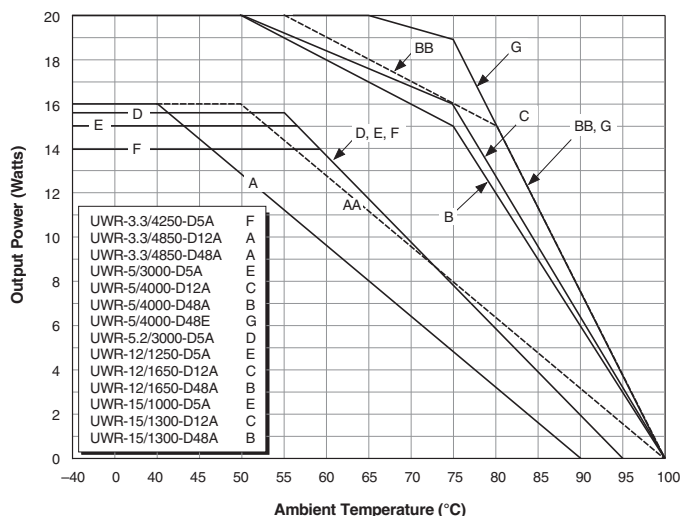

- UWR-3.3/4850-D48A (18-75V input, curve A) and UWR-3.3/4850-D12A (9-36V input, curve A) will derate curve AA if used over the limited input ranges of 20-60V or 10-30V, respectively.
- "D48A" models (18-75V input ranges) that derate along curve B will derate along curve BB if used over the more limited input range of 24-60V.

Mechanical Specifications

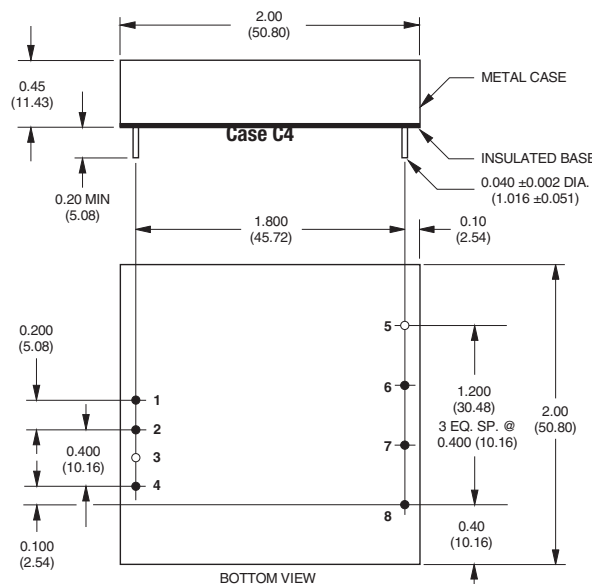

I/O Connections

Pin	Function P6
1	+Input
2	-Input
3	Pin not installed
4	On/Off Control
5	Pin not installed
6	+Output
7	Common
8	Trim

Dimensions are in inches (mm) shown for ref. only.

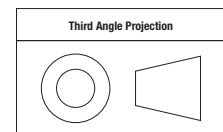

Tolerances (unless otherwise specified):
.XX ± 0.02 (0.5)
.XXX ± 0.010 (0.25)
Angles ± 2°

Components are shown for reference only.

Notes:

For "D5A" and "D12A" models, the case is connected to pin 2 (-V_{IN}).
For "D48A" and "D48E" models, the case is connected to pin 1 (+V_{IN}).

Performance/Functional Specifications

Typical @ T_A = +25°C under nominal line voltage and full-load conditions, unless noted. ①

Input	
Input Voltage Range:	
D5A Models	4.7-7.5 Volts (5V nominal)
D12A Models	9-36 Volts (24V nominal)
D48A/D48E Models	18-75/36-72 Volts (48V nominal)
Input Current	See Ordering Guide
Input Filter Type	Pi (C-type for D5A models)
Overvoltage Shutdown:	
D5A Models	10 Volts
D12A Models	40 Volts
D48A and /D48E Models	80 Volts
Reverse-Polarity Protection	Yes (Instantaneous, 10A maximum)
On/Off (Sync.) Control (Pin 4)②	TTL high = off, low (or open) = on
Output	
V_{OUT} Accuracy (50% load)	±1%, maximum
Temperature Coefficient	±0.02% per °C
Ripple/Noise (20MHz BW)	See Ordering Guide
Line/Load Regulation	See Ordering Guide
Efficiency	See Ordering Guide
Isolation Voltage ③	1500Vdc guaranteed
Isolation Capacitance	550pF
Current Limiting	Auto-recovery
Overvoltage Protection	Zener/transorb clamp, magnetic feedback
Dynamic Characteristics	
Transient Response (50% load step)	200µsec max. to ±1.5% of final value
Switching Frequency	165kHz (±15kHz)
Environmental	
Operating Temperature (Ambient):	
Without Derating	-40 to +40/50/55/65°C (Model dependent)
With Derating	to +100°C (See Derating Curves)
Storage Temperature	-40 to +105°C
Flammability	UL94V-0
Physical	
Dimensions	2" x 2" x 0.45" (51 x 51 x 11.4mm)
Shielding	5-sided
Case Connection:	
D5A, D12A Models	Pin 2 (-V _{IN})
D48A, D48E Models	Pin 1 (+V _{IN})
Case Material	Corrosion resistant steel with non-conductive, epoxy-based, black enamel finish and plastic baseplate
Pin Material	RoHS: Gold-plated copper alloy Non-RoHS: Tin over copper alloy
Weight	2.7 ounces (76.5 grams)

① These converters require a minimum 10% loading to maintain specified regulation. Operation under no-load conditions will not damage these devices; however they may not meet all listed specifications.

② Applying a voltage to the Control pin when no input power is applied to the converter can cause permanent damage to the converter. TTL Logic High of +3.3V to +5V max will disable the converter.

③ "D48A" models have BASIC, all other models have Functional insulation. Devices can be screened or modified for higher guaranteed isolation voltages. Contact Murata Power Solutions Applications Engineering for details.

Absolute Maximum Ratings	
Input Voltage:	
"D5A" Models	11 Volts
"D12A" Models	44 Volts
"D48A" and "D48E" Models	88 Volts
Input Reverse-Polarity Protection	Current must be <10A. Brief duration only. Fusing recommended.
Output Overvoltage Protection:	
3.3V Outputs	No protection
5V/5.2V Outputs	6.8 Volts, limited duration
12V Outputs	15 Volts, limited duration
15V Outputs	18 Volts, limited duration
Output Current	Current limited. Max. current and short-circuit duration are model dependent
Storage Temperature	-40 to +105°C
Lead Temperature	See soldering guidelines
These are stress ratings. Exposure of devices in excess of these conditions may adversely affect long-term reliability. Proper operation under conditions other than those listed in the Performance/Functional Specifications Table is not implied.	

TECHNICAL NOTES

Floating Outputs

Since these are isolated DC/DC converters, their outputs are "floating." Users may ground either the Common (pin 7) for normal usage or the positive side (+Output, pin 6) to effectively reverse the output polarity.

Filtering and Noise Reduction

All A-Series UWR 14-20 Watt DC/DC Converters achieve their rated ripple and noise specifications without the use of external input/output capacitors. In critical applications, input/output noise may be further reduced by installing electrolytic capacitors across the input terminals and/or low-ESR tantalum or electrolytic capacitors across the output terminals. The caps should be located as close to the power converters as possible. Typical values are listed below. In many applications, using values greater than those listed will yield better results.

To Reduce Input Ripple

D5A Models	47µF, 16V
D12A Models	20µF, 50V
D48A Models	20-50µF, 100V

To Reduce Output Ripple

3.3V Outputs	100µF, 6V, Low ESR
5V/5.2V Outputs	47µF, 10V, Low ESR
12/15V Outputs	22µF, 20V, Low ESR

Input Fusing

Certain applications and/or safety agencies may require the installation of fuses at the inputs of power conversion components. For Murata Power Solutions A-Series UWR 14-20 Watt DC/DC Converters, you should use slow-blow type fuses with values no greater than the following:

V _{IN} Range	Fuse Value
D5A	6A
D12A	4A
D48A/D48E	2A

On/Off Control

The On/Off Control pin (pin 4) may be used for remote on/off operation. A TTL logic high (+2 to +5 Volts, 250µA max.) applied to pin 4 disables the converter. A TTL logic low (0 to +0.8 Volts, 70µA max.), or no connection, enables the converter. Control voltages should be referenced to pin 2 (-Input). Applying a voltage to the Control pin when no input power is applied to the converter can cause permanent damage to the converter.

Output Trimming

V_{OUT} may be trimmed up +5% only via a single external trimpot or fixed resistor. The trimpot should be connected as shown in Figure 2a with its wiper connected to pin 8 (Trim). A trimpot can be used to determine the value of a single fixed resistor which should be connected as shown in Figure 2b. Connect the resistor between pins 8 and 7 (Common) to trim "up" the output voltage. Fixed resistors should be metal-film types with absolute TCR's less than 100ppm/°C to ensure stability.

Custom Capabilities

Murata Power Solutions' world-class design, development and manufacturing team stands ready to work with you to deliver the exact power converter you need for your demanding, large volume, OEM applications. More importantly . . . we'll do it on time and within budget!

Our experienced applications and design staffs; quick-turn prototype capability; highly automated, SMT assembly facilities; and in-line SPC quality-control techniques combine to give us the unique ability to design and deliver any quantity of power converters to the highest standards of quality and reliability.

We have compiled a large library of DC/DC designs that are currently used in a variety of telecom, medical, computer, railway, aerospace and industrial applications. We may already have the converter you need.

Contact us. Our goal is to provide you the highest-quality, most cost-effective power converters available.

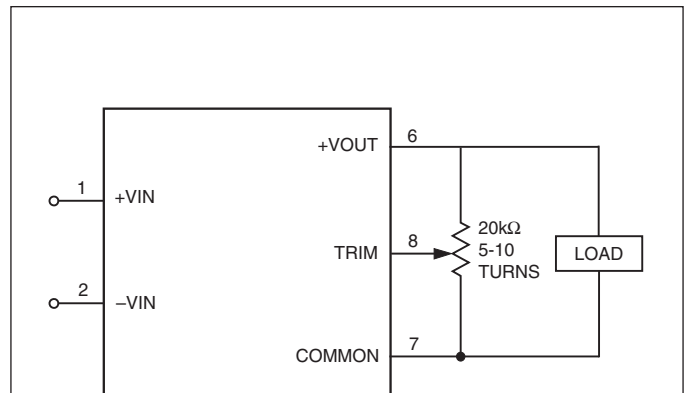

Figure 2a. Trim Connections Using a Trimpot

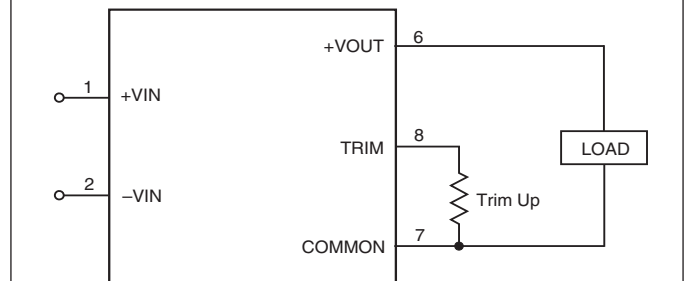

Figure 2b. Trim Connections Using Fixed Resistors

Soldering Guidelines

Murata Power Solutions recommends the specifications below when installing these converters. These specifications vary depending on the solder type. Exceeding these specifications may cause damage to the product. Your production environment may differ; therefore please thoroughly review these guidelines with your process engineers.

Wave Solder Operations for through-hole mounted products (THMT)

For Sn/Ag/Cu based solders:

Maximum Preheat Temperature	115° C.
Maximum Pot Temperature	270° C.
Maximum Solder Dwell Time	7 seconds

For Sn/Pb based solders:

Maximum Preheat Temperature	105° C.
Maximum Pot Temperature	250° C.
Maximum Solder Dwell Time	6 seconds

Typical Performance Curves (T_A = +25°C)

The performance curves below were derived from actual test data for a single model number (UWR-5/4000-D12A). Since all devices in the 14-20W UWR A-Series have the same circuit topology, the performance curves are representative of all devices.

EFFICIENCY

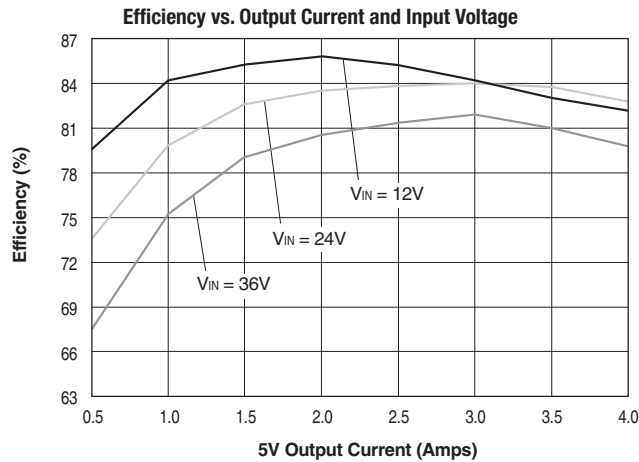

LINE REGULATION

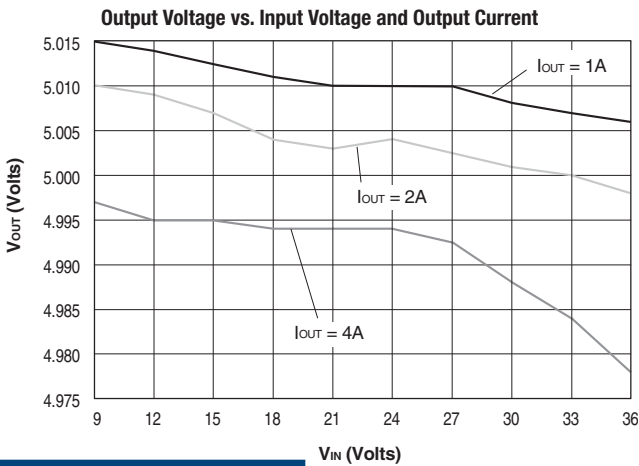

LOAD REGULATION

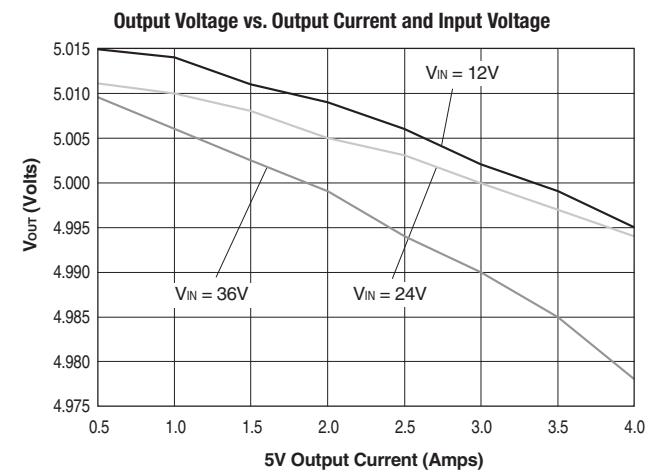

EMI RADIATED EMISSIONS

If you're designing with EMC in mind, please note that all of Murata Power Solutions' UWR 14-20 Watt A-Series DC/DC Converters have been characterized for radiated and conducted emissions in our new EMI/EMC laboratory. Testing is conducted in an EMCO 5305 GTEM test cell utilizing EMCO automated EMC test software. Radiated emissions are tested to the limits of FCC Part 15, Class B and CISPR 22 (EN 55022), Class B. Radiated emissions plots to FCC and CISPR 22 for model UWR-5/4000-D12A appear below.

**UWR-5/4000-D12A Radiated Emissions
FCC Part 15 Class B, 3 Meters
Converter Output = 5Vdc @ 3.6A**

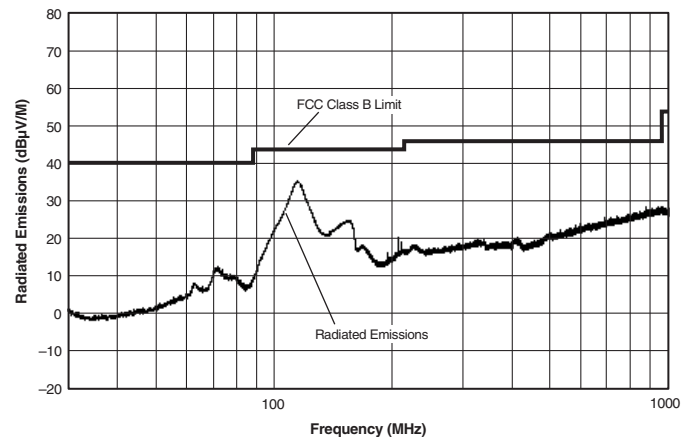

**UWR-5/4000-D12A Radiated Emissions
EN 55022 Class B, 10 Meters
Converter Output = +5Vdc @ 3.6A**

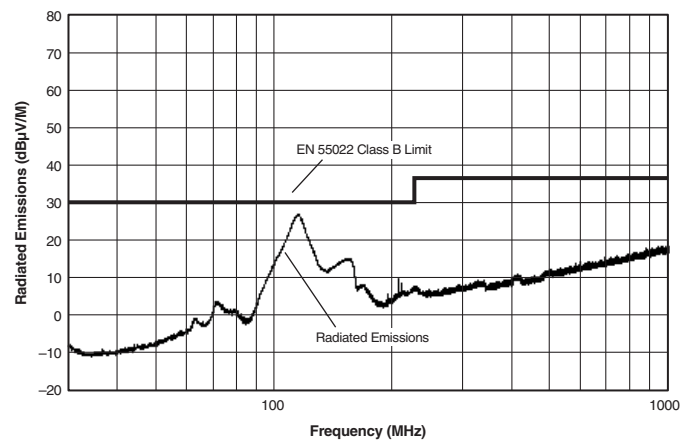

Quality and Reliability

The A-Series are the first DC/DC Converters to emerge from Murata Power Solutions' new, company-wide approach to designing and manufacturing the most reliable power converters available. The five-pronged program draws our Quality Assurance function into all aspects of new-product design, development, characterization, qualification and manufacturing.

Design for Reliability

Design for Reliability is woven throughout our multi-phased, new-product-development process. Design-for-reliability practices are fully documented and begin early in the new-product development cycle with the following goals:

1. To work from an approved components/vendors list ensuring the use of reliable components and the rigorous qualification of new components.
2. To design with safety margins by adhering to a strict set of derating guidelines and performing theoretical worst-case analyses.
3. To locate potential design weaknesses early in the product-development cycle by using extensive HALT (Highly Accelerated Life Testing).
4. To prove that early design improvements are effective by employing a thorough FRACA (Failure Reporting Analysis and Corrective Action) system.

HALT Testing

The goal of the accelerated-stress techniques used by Murata Power Solutions is to force device maturity, in a short period of time, by exposing devices to excessive levels of "every stimulus of potential value." We use HALT (Highly Accelerated Life Testing) repeatedly during the design and early manufacturing phases to detect potential electrical and mechanical design weaknesses that could result in possible future field failures.

During HALT, prototype and pre-production DC/DC converters are subjected to progressively higher stress levels induced by thermal cycling, rate of temperature change, vibration, power cycling, product-specific stresses (such as dc voltage variation) and combined environments. The stresses are not meant to simulate field environments but to expose any weaknesses in a product's electro/mechanical design and/or assembly processes. The goal of HALT is to make products fail so that device weaknesses can be analyzed and strengthened as appropriate. Applied stresses are continually stepped up until products eventually fail. After corrective actions and/or design changes, stresses are stepped up again and the cycle is repeated until the "fundamental limit of the technology" is determined.

Typical HALT Profile

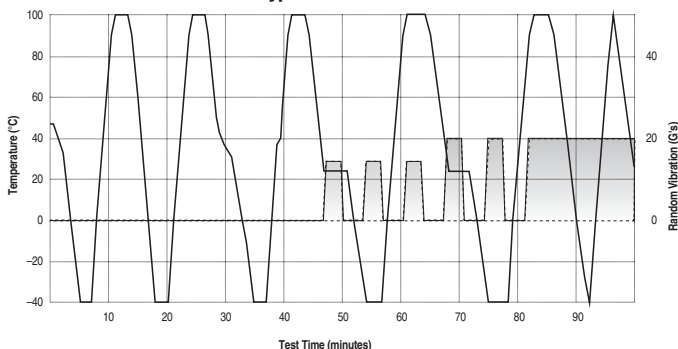

Murata Power Solutions has invested in a Qualmark OVS-1 HALT tester capable of applying voltage and temperature extremes as well as 6-axis, linear and rotational, random vibration. A typical HALT profile (shown above) consists of thermal cycling (-55 to +125°C, 30°C/minute) and simultaneous, gradually increasing, random longitudinal and rotational vibration up to 20G's with load cycling and applied-voltage extremes added as desired. Many devices in Murata Power Solutions' new A-Series could not be made to fail prior to reaching either the limits of the HALT chamber or some previously known physical limit of the device. We also use the HALT chamber and its ability to rapidly cool devices to verify their "cold-start" capabilities.

Qualification

For each new product, electrical performance is verified via a comprehensive characterization process and long-term reliability is confirmed via a rigorous qualification procedure. The qual procedure includes such strenuous tests as thermal shock and 500 hour life. Qual testing is summarized below.

Qualification Testing

Qualification Test	Method/Comments
HALT	Murata Power Solutions in-house procedure
High Temperature Storage	Max. rated temp., 1,000 hours
Thermal Shock	10 cycles, -55 to +125°C
Temperature/Humidity	+85°C, 85% humidity, 48 hours
Lead Integrity	Murata Power Solutions in-house procedure
Life Test	+70°C, 500 hours*
Marking Permanency	Murata Power Solutions in-house procedure
End Point Electrical Tests	Per product specification

* Interim electrical test at 200 hours.

In-Line Process Controls and Screening

A combination of statistical sampling and 100% inspection techniques keeps our assembly line under constant control. Parameters such as solder-paste thickness, component placement, cleanliness, etc. are statistically sampled, charted and fine tuned as necessary. Visual inspections are performed by trained operators after pick-and-place, soldering and cleaning operations. Units are 100% electrically tested prior to potting. All devices are temperature cycled, burned-in, hi-pot tested and final-electrical tested prior to external visual examination, packing and shipping.

Rapid Response to Problems

Murata Power Solutions employs an outstanding corrective-action system to immediately address any detected shortcomings in either products or processes. Whenever our assembly, quality or engineering personnel spot a product/process problem, or if a product is returned with a potential defect, we immediately perform a detailed failure analysis and, if necessary, undertake corrective actions. Over time, this system has helped refine our assembly operation to yield one of the lowest product defect rates in the industry.

Murata Power Solutions, Inc.
11 Cabot Boulevard, Mansfield, MA 02048-1151 U.S.A.
ISO 9001 and 14001 REGISTERED



This product is subject to the following [operating requirements](http://www.murata-ps.com/requirements/) and the [Life and Safety Critical Application Sales Policy](#): Refer to: <http://www.murata-ps.com/requirements/>

Murata Power Solutions, Inc. makes no representation that the use of its products in the circuits described herein, or the use of other technical information contained herein, will not infringe upon existing or future patent rights. The descriptions contained herein do not imply the granting of licenses to make, use, or sell equipment constructed in accordance therewith. Specifications are subject to change without notice. © 2015 Murata Power Solutions, Inc.

Looking for pricing, stock, or lifecycle information?

Click below to explore more details on WIN SOURCE:

- [View UWR-12/1650-D48A-C on WIN SOURCE](#)
- [Murata Power Solutions Inc. Information](#)

Optimize Your Supply Chain with WIN SOURCE Solutions

- ✓ Global Sourcing Solution
- ✓ Obsolete Management
- ✓ Cost Control Management
- ✓ Shortage Management
- ✓ Alternative Solution
- ✓ Excess Inventory Management