



**THE DATASHEET OF
UWR-3.3/4250-D24ACT-C**





Typical units

FEATURES

- 1.2-2.5V_{OUT} models source 6 Amps
- 3.3V_{OUT} models source 4.25 Amps
- 5/12/15V_{OUT} models deliver full 15 Watts
- Synchronous-rectifier topologies
- Guaranteed efficiencies to 88%
- Choice of 3 input voltage ranges: 10-18V, 18-36V, 36-75V
- -40 to +60/70°C ambient w/o derating
- Fully isolated (1500Vdc); I/O protected
- Meets UL/IE/EN60950-1 certification, 2nd Edition
- CE mark (75V_{IN} models)
- Standard 1" x 2" packages and pinouts
- Optional V_{OUT} trim and on/off control

PRODUCT OVERVIEW

The new 1.2, 1.5V, 1.8V and 2.5V models in Murata Power Solutions' flagship 7-15 Watt A-Series can source a continuous 6 Amps. This is the most "low-voltage" current available from a standard 1" x 2" package, and these power converters exemplify Murata Power Solutions' relentless drive to bring you more power/current, from standard packages, without compromising reliability or resorting to thermal specmanship.

By combining a high-frequency, high-efficiency (to 88%), synchronous-rectifier topology with the newest components and time-tested, fully automated, SMT-on-pcb construction, these UWR Models are able to bring you 7-15W (@ up to 6A) in the standard 1" x 2" package from which most competitors can only get 5-10W (@ 3-4A). All UWR's deliver their full output power over ambient temperature ranges from -40°C to as high as +70°C (model and input voltage

dependent) without heat sinks or supplemental forced-air cooling. Devices derate to +100°C.

Output voltages are 1.2, 1.5, 1.8, 2.5, 3.3, 5, 12 or 15 Volts. Input voltage ranges are 10-18V (D12 models), 18-36V (D24 models) or 36-75V (D48 models). All models feature input pi filters, input undervoltage and overvoltage lockout, input reverse-polarity protection, output overvoltage protection, output current limiting, and continuous short-circuit protection. On/off control and output-trim functions are optional (see Optional Functions). All models are designed to meet IEC950, UL1950 and EN60950-1, 2nd Edition safety requirements. D48 models (36-75V inputs) are CE marked.

UWR 7-15W DC/DC's are packaged in low-cost, light-weight, diallyl phthalate (UL94V-0 rated) plastic packages with standoffs. EMC compliance is achieved via a low-noise design rather than through expensive metal shielding.

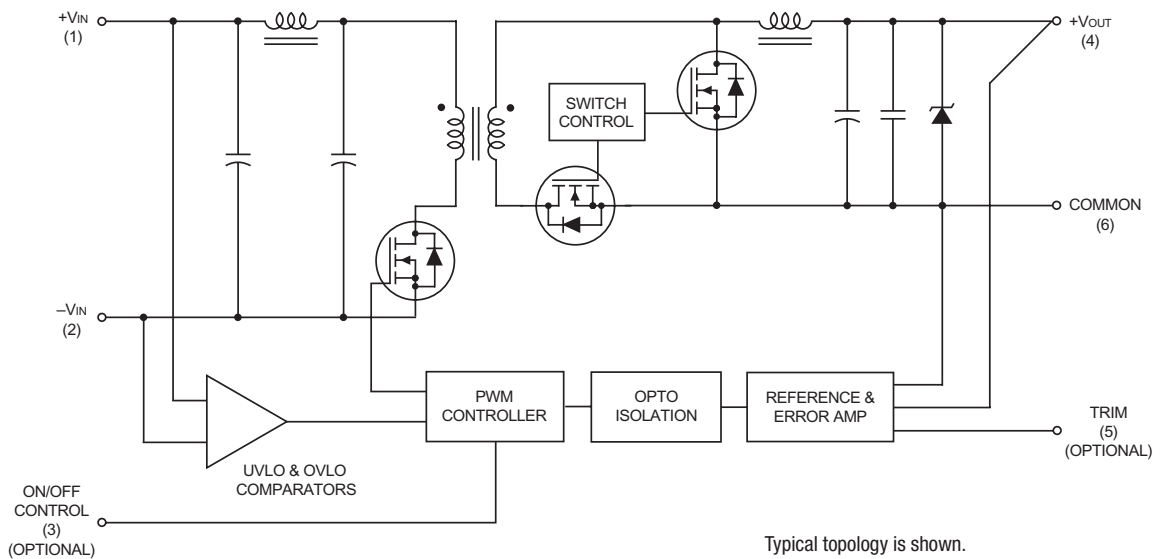

Typical topology is shown.

Figure 1. Simplified Schematic



Performance Specifications and Ordering Guide ①

ORDERING GUIDE													
Root Model ⑦	Output							Input			Efficiency		Package (Case, Pinout)
	Vout (Volts)	Iout (mA)	R/N (mV p-p) ②		Regulation (max.)		Vin nom. (Volts)	Range (Volts)	Iin (mA) ④	Min.	Typ.		
			Typ.	Max.	Line	Load ③							
Discontinued	UWR-1.2/6000-D12A-C	1.2	6000	40	75	±0.2%	±0.5%	12	10-18	80/769	76%	78%	C14, P22
Discontinued	UWR-1.2/6000-D24A-C	1.2	6000	40	75	±0.05%	±0.75%	24	18-36	45/375	78%	80%	C14, P22
Discontinued	UWR-1.2/6000-D48A-C	1.2	6000	40	75	±0.2%	±0.5%	48	36-75	80/188	78%	80%	C14, P22
Discontinued	UWR-1.5/6000-D12A-C	1.5	6000	30	55	±0.1%	±0.5%	12	10-18	75/914	77.5%	79.5%	C14, P22
Discontinued	UWR-1.5/6000-D24A-C	1.5	6000	30	55	±0.1%	±0.5%	24	18-36	40/454	78%	80%	C14, P22
Discontinued	UWR-1.5/6000-D48A-C	1.5	6000	30	55	±0.1%	±0.5%	48	36-75	25/226	78.5%	80.5%	C14, P22
Discontinued	UWR-1.8/6000-D12A-C	1.8	6000	30	55	±0.1%	±0.5%	12	10-18	70/1084	81%	83%	C14, P22
Discontinued	UWR-1.8/6000-D24A-C	1.8	6000	30	55	±0.1%	±0.5%	24	18-36	35/539	82.5%	84.5%	C14, P22
Discontinued	UWR-1.8/6000-D48A-C	1.8	6000	30	55	±0.1%	±0.5%	48	36-75	25/268	83%	85%	C14, P22
Discontinued	UWR-2.5/6000-D12A-C	2.5	6000	30	55	±0.1%	±0.5%	12	10-18	80/1489	83%	86%	C14, P22
Discontinued	UWR-2.5/6000-D24A-C	2.5	6000	30	50	±0.075%	±0.25%	24	18-36	45/727	84.75%	86%	C14, P22
Discontinued	UWR-2.5/6000-D48A-C	2.5	6000	30	55	±0.1%	±0.5%	48	36-75	25/367	84%	86%	C14, P22
Available	UWR-3.3/4250-D12A-C	3.3	4250	85	100	±0.2%	±0.5%	12	10-18	80/1375	83%	86%	C14, P22
Available	UWR-3.3/4250-D24A-C	3.3	4250	45	70	±0.2%	±0.5%	24	18-36	45/672	85%	87%	C14, P22
Available	UWR-3.3/4250-D48A-C	3.3	4250	85	100	±0.2%	±0.5%	48	36-75	35/336	85%	87%	C14, P22
Discontinued	UWR-3.3/4500-D48ANT-C ⑤	3.3	4500	85	100	±0.2%	±0.5%	48	36-75	35/356	85%	87%	C14, P22
Available	UWR-5/3000-D12A-C	5	3000	85	100	±0.2%	±0.3%	12	10-18	110/1471	83%	85%	C14, P22
Available	UWR-5/3000-D24A-C	5	3000	85	100	±0.2%	±0.3%	24	18-36	55/710	85.5%	88%	C14, P22
Discontinued	UWR-5/3000-D24AT-C	5	3000	85	100	±0.2%	±0.3%	24	18-36	55/710	85.5%	88%	C14, P22
Available	UWR-5/3000-D48A-C	5	3000	85	100	±0.2%	±0.3%	48	36-75	35/355	85.5%	88%	C14, P22
Discontinued	UWR-5/3000-D48ANST-C ⑥	5	3000	85	100	±0.2%	±0.3%	48	36-75	35/355	85.5%	88%	C14, P22
Available	UWR-12/1250-D12A-C	12	1250	85	100	±0.2%	±0.3%	12	10-18	45/1471	82.5%	85%	C14, P22
Available	UWR-12/1250-D24A-C	12	1250	85	100	±0.2%	±0.3%	24	18-36	45/718	85%	87%	C14, P22
Discontinued	UWR-12/1250-D48A-C	12	1250	85	100	±0.2%	±0.3%	48	36-75	20/359	85%	87%	C14, P22
Discontinued	UWR-15/1000-D12A-C	15	1000	85	100	±0.2%	±0.3%	12	10-18	45/1471	82.5%	85%	C14, P22
Available	UWR-15/1000-D24A-C	15	1000	85	100	±0.2%	±0.3%	24	18-36	45/718	85%	87%	C14, P22
Discontinued	UWR-15/1000-D48A-C	15	1000	85	100	±0.2%	±0.3%	48	36-75	20/359	85%	87%	C14, P22

As of October 2016, ONLY the following part numbers will be available: UWR-3.3/4250-D12A-C; UWR-3.3/4250-D24A-C; UWR-3.3/4250-D24ACT-C; UWR-3.3/4250-D48A-C; UWR-5/3000-D12A-C; UWR-5/3000-D24A-C; UWR-5/3000-D48A-C; UWR-12/1250-D12A-C; UWR-12/1250-D24A-C; UWR-15/1000-D24AT-C.

① Typical at TA = +25°C under nominal line voltage and full-load conditions, unless otherwise noted.
 ② Ripple/Noise (R/N) is tested/specified over a 20MHz bandwidth. All models are specified with two external 0.47µF multi-layer ceramic capacitors located 2-3 inches from the module being tested.
 ③ Load regulation is specified over 10%-100% load conditions. 1.5-5V models are stable and regulate under no-load conditions. 12/15V models have minimum loading requirements See Performance/Functional Specifications.

④ Nominal line voltage, no-load/full-load conditions.
 ⑤ See page 12.
 ⑥ Special trim version. See Trim Equations, page 5. Quantity order required.
 ⑦ Please refer to the Part Number Structure for additional options when ordering.

For Part Number Structure, please see page 12.

Performance/Functional Specifications

Typical @ T_A = +25°C under nominal line voltage and full-load conditions, unless noted. ① ②

Input	
Input Voltage Range:	
D12A Models	10-18 Volts (12V nominal)
D24A Models	18-36 Volts (24V nominal)
D48A Models	36-75 Volts (48V nominal)
Overvoltage Shutdown:	
D12A Models	18.5-21 Volts (20V typical)
D24A Models	37-41 Volts (38V typical)
D48A Models	77-81 Volts (78.5V typical)
Start-Up Threshold: ③	
D12A Models	9.4-10 Volts (9.6V typical)
D24A Models	16.5-18 Volts (17V typical)
D48A Models	34-36 Volts (35V typical)
Undervoltage Shutdown: ③	
D12A Models	7-8.5 Volts (8V typical)
D24A Models	15.5-17.5 Volts (16.5V typical)
D48A Models	32.5-35.5 Volts (34V typical)
Input Current:	
Normal Operating Conditions	See Ordering Guide
Standby Mode (Off, OV, UV)	5mA
Input Filter Type	Pi
Reverse-Polarity Protection	Brief duration, 10A maximum
On/Off Control (Optional, Pin 3): ④ ⑤	
D12AC, D24AC, & D48AC Models	On = open or 13V to +V _{IN} , I _{IN} = 1-5mA typ. Off = 0-0.8V, I _{IN} = 3-12mA typ.
D12AN, D24AN, & D48AN Models	On = 0-0.8V, I _{IN} = 3-12mA typ. Off = open or 3.3-5.5V, I _{IN} = 1-5mA typ.
Output	
V_{OUT} Accuracy (50% load):	±1.5% (±2% for model UWR-1.2/6000)
Minimum Loading for Specification: ②	
1.2V/1.5V/1.8V/2.5V/3.3V/5V Outputs	No load
12V/15V Outputs	10% of I _{OUT} max.
Minimum Loading for Stability: ②	
1.2V/1.5V/1.8V/2.5V/3.3V/5V Outputs	No load
12V/15V Outputs	25mA
Ripple/Noise (20MHz BW) ① ⑥	See Ordering Guide
Line/Load Regulation	See Ordering Guide
Efficiency	See Ordering Guide
Isolation Voltage:	
Input-to-Output	1500Vdc minimum (functional)
Isolation Capacitance	470pF
Isolation Resistance	100MΩ
Current Limiting:	
1.2V-5V Outputs	Hiccup technique, auto-recovery
12V and 15V Outputs	Power-limiting technique, auto-recovery
Overvoltage Protection	Zener/transorb clamp, magnetic feedback
Temperature Coefficient	±0.04% per °C
Dynamic Characteristics	
Transient Response (50% load step)	
1.2V-2.5V models	200µsec max. to ±2% of final value
3.3V-15V models	200µsec max. to ±1.5% of final value
Start-Up Time: ③	
V _{IN} to V _{OUT}	50msec
On/Off to V _{OUT}	30msec

Dynamic Characteristics (continued)

Switching Frequency	
1.2V models	250-300kHz ±30kHz, model dependent
1.5V D48 models	260kHz (±30kHz)
1.8V D12 models	280kHz (±30kHz)
1.8V D24 models	250kHz (±30kHz)
1.8V D48 models	210kHz (±20kHz)
2.5 and 1.5 D12/D24 models	340kHz (±40kHz)
3.3-12V models	310-345kHz ±10%, model dependent
Environmental	
Operating Temperature (Ambient): (See Derating Curves)	-40 to +85°C with Derating
Case Temperature: Maximum Allowable	+100°C
Storage Temperature	-40 to +105°C
Physical	
Dimensions	2" x 1" x 0.475" (51 x 25 x 12.1mm)
Shielding	None
Case Material	Diallyl phthalate, UL94V-0 rated
Pin Material	Gold-plated copper alloy with nickel underplate
Weight	1.4 ounces (39.7 grams)

- ① All models are specified with two external 0.47µF multi-layer ceramic capacitors installed across their output pins.
- ② See Minimum Output Loading Requirements under Technical Notes.
- ③ See Technical Notes for details.
- ④ The On/Off Control and Trim functions are optional and must be installed by MPS. See Optional Functions or contact MPS for details.
- ⑤ The On/Off Control is designed to be driven with open-collector logic or the application of appropriate voltages (referenced to -Input, pin 2). Applying a voltage to the On/Off Control pin when no input voltage is applied to the converter may cause permanent damage. See Technical Notes.
- ⑥ Output noise maybe further reduced with the addition of additional external output capacitors. See Technical Notes.
- ⑦ Operating temperature range without derating is model and input-voltage dependent. See Temperature Derating.
- ⑧ RoHS-6 hazardous substance compliance does not claim EU RoHS exemption 7b (lead in solder).

Absolute Maximum Ratings

Input Voltage:	
Continuous:	
D12 Models	22 Volts
D24 Models	44 Volts
D48 Models	88 Volts
Transient (100msec):	
D12 Models	50 Volts
D24 Models	50 Volts
D48 Models	100 Volts
Input Reverse-Polarity Protection	Current must be <10 Amps. Brief duration only. Fusing recommended.
Output Overvoltage Protection:	
1.2V/1.5V/1.8V Outputs	2.1/2.2/2.3 Volts, unlimited duration
2.5V/3.3V Outputs	TBD/3.4/4.4 Volts, unlimited duration
5V/12V/15V Outputs	7.1/16/18 Volts, unlimited duration
Output Current	Current limited. Devices can withstand sustained output short circuits without damage.
Case Temperature	+100°C
Storage Temperature	-40 to +105°C
Lead Temperature	See soldering guidelines
These are stress ratings. Exposure of devices to greater than any of these conditions may adversely affect long-term reliability. Proper operation under conditions other than those listed in the Performance/Functional Specifications Table is not implied.	

Floating Outputs

Since these are isolated DC/DC converters, their outputs are "floating." Designers will usually use the output Common (pin 6) as the ground/return of the load circuit. You can, however, use the +Output (pin 4) as ground/return to effectively reverse the output polarity.

Minimum Output Loading Requirements

1.2 to 5V models employ a synchronous-rectifier design topology. All models regulate within spec and are stable under no-load conditions. 12/15V models employ a traditional forward architecture and require 10% loading (125mA for 12V models, 100mA for 15V models) to achieve their listed regulation specs. 12/15V models also have a minimum-load-for-stability requirement (20mA).

For 12/15V models, operation below 20mA or 10% loading will be stable but regulation may degrade. A 100µF output capacitor is recommended below 10% loading. Users should verify whether this relaxed regulation will have any effect on output circuits. If so, add a small load of 10% or greater.

Operation under no-load conditions will not damage 12/15V converters. However they may not meet all listed specifications.

Filtering and Noise Reduction

All A-Series UWR DC/DC Converters achieve their rated ripple and noise specifications using the external input and output capacitors specified in the Performance/Functional Specifications table. In critical applications, input/output noise may be further reduced by installing additional external I/O caps. Input capacitors should be selected for bulk capacitance, low ESR and high rms-ripple-current ratings. Output capacitors should be selected for low ESR and appropriate frequency response. All caps should have appropriate voltage ratings and be mounted 2-3 inches from the converter to achieve published ratings. The most effective combination of external I/O capacitors will be a function of your particular load and layout conditions.

Input Fusing

Certain applications and/or safety agencies may require the installation of fuses at the inputs of power conversion components. Fuses should also be used if the possibility of sustained, non-current-limited, input-voltage polarity reversals exists. For MPS's A-Series UWR 7-15 Watt DC/DC Converters, you should use fast-blow type fuses with values no greater than the following.

V _{IN} Range	Fuse Value
"D12A" Models	3 Amps
"D24A" Models	2 Amps
"D48A" Models	1 Amp

Maximum Case Temperature

The +100 degree C. maximum outside case temperature specification is based on much empirical testing on encapsulated units. Those tests show that if the case exterior can be maintained at or below +100C., the hottest internal components' package temperatures will not exceed +128C. because of the internal temperature gradient to the exterior case. This latter +128C. internal figure is a safety margin offering more protection for the internal components. The +100C. case specification must be achieved by the user's combination of lower output current and/or higher airflow.

If you attempt any of your own case temperature testing, please be aware of the heatsinking effect of attaching wired thermocouples to surfaces. An infra-

red camera is another alternative which avoids the TC heatsinking effect. But the IR camera must be calibrated frequently and accurately. Remember too that it is quite difficult to accurately measure airflow right at the converter. Murata Power Solutions uses a calibrated wind tunnel with large amounts of data history. Because of thermal time constants, allow plenty of time for temperature stabilization.

Trimming Output Voltages

These converters have a trim capability (pin 5) that allows users to adjust the output voltage ±5%. Adjustments to the output voltage can be accomplished via a trim pot, Figure 2, or a single fixed resistor as shown in Figures 3 and 4. A single fixed resistor can increase or decrease the output voltage depending on its connection. Fixed resistors should have an absolute TCR less than 100ppm/°C to minimize sensitivity to changes in temperature.

A single resistor connected from the Trim (pin 5) to the +Output (pin 4), see Figure 3, will decrease the output voltage. A resistor connected from the Trim (pin 5) to Output Common (pin 6) will increase the output voltage.

Trim adjustment greater than 5% can have an adverse effect on the converter's performance and is not recommended.

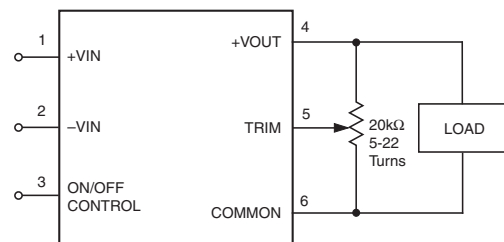

Figure 2. Trim Connections Using A Trim Pot

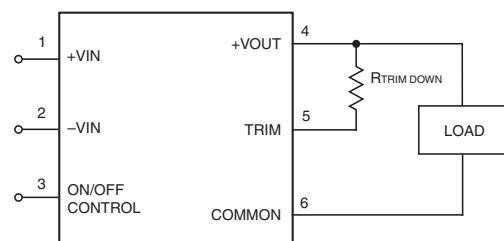

Figure 3. Trim Connections To Decrease Output Voltage Using Fixed Resistors

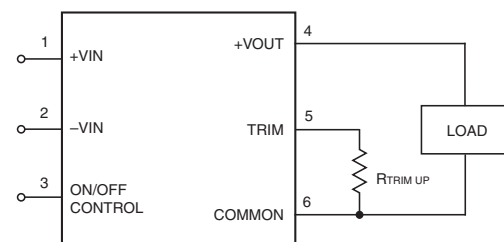

Figure 4. Trim Connections To Increase Output Voltage Using Fixed Resistors

Model	Trim Equation
UWR-1.2/6000-D12A UWR-1.2/6000-D24A UWR-1.2/6000-D48A	$R_{T_DOWN} (k\Omega) = \frac{5.32(V_O - 0.7)}{1.2 - V_O} - 2$ $R_{T_UP} (k\Omega) = \frac{3.73}{V_O - 1.2} - 2$
UWR-1.5/6000-D12A UWR-1.5/6000-D24A UWR-1.5/6000-D48A	$R_{T_DOWN} (k\Omega) = \frac{1.6(V_O - 1.23)}{1.5 - V_O} - 2$ $R_{T_UP} (k\Omega) = \frac{1.968}{V_O - 1.5} - 2$
UWR-1.8/6000-D12A UWR-1.8/6000-D24A UWR-1.8/6000-D48A	$R_{T_DOWN} (k\Omega) = \frac{0.995(V_O - 1.24)}{1.8 - V_O} - 2.49$ $R_{T_UP} (k\Omega) = \frac{1.23}{V_O - 1.8} - 2.49$
UWR-2.5/6000-D12A UWR-2.5/6000-D24A UWR-2.5/6000-D48A	$R_{T_DOWN} (k\Omega) = \frac{2(V_O - 1.24)}{2.5 - V_O} - 11$ $R_{T_UP} (k\Omega) = \frac{2.48}{V_O - 2.5} - 11$
UWR-3.3/4250-D12A UWR-3.3/4250-D24A UWR-3.3/4250-D48A	$R_{T_DOWN} (k\Omega) = \frac{2.49(V_O - 1.27)}{3.3 - V_O} - 16.9$ $R_{T_UP} (k\Omega) = \frac{3.16}{V_O - 3.3} - 16.9$

Model	Trim Equation
UWR-3.3/4500-D48ANT	$R_{T_DOWN} (k\Omega) = \frac{1.27}{K} - 8.25$ where $K = \frac{3.3 - V_O}{3.3}$ $R_{T_UP} (k\Omega) = \frac{0.78}{K} - 6.2$ where $K = \frac{V_O - 3.3}{3.3}$
UWR-5/3000-D12A UWR-5/3000-D24A UWR-5/3000-D48A	$R_{T_DOWN} (k\Omega) = \frac{2.49(V_O - 2.527)}{5 - V_O} - 15$ $R_{T_UP} (k\Omega) = \frac{6.292}{V_O - 5} - 15$
UWR-5/3000-D48ANST	$R_{T_DOWN} (k\Omega) = \frac{7.5(V_O - 1.24)}{5.0 - V_O}$ $R_{T_UP} (k\Omega) = \frac{9.3}{V_O - 4.997} - 10$
UWR-12/1250-D12A UWR-12/1250-D24A UWR-12/1250-D48A	$R_{T_DOWN} (k\Omega) = \frac{6.34(V_O - 5.714)}{12 - V_O} - 49.9$ $R_{T_UP} (k\Omega) = \frac{36.23}{V_O - 12} - 49.9$
UWR-15/1000-D12A UWR-15/1000-D24A UWR-15/1000-D48A	$R_{T_DOWN} (k\Omega) = \frac{7.87(V_O - 7.136)}{15 - V_O} - 63.4$ $R_{T_UP} (k\Omega) = \frac{56.16}{V_O - 15} - 63.4$

Soldering Guidelines

Murata Power Solutions recommends the specifications below when installing these converters. These specifications vary depending on the solder type. Exceeding these specifications may cause damage to the product. Be cautious when there is high atmospheric humidity. Your production environment may differ; therefore please thoroughly review these guidelines with your process engineers.

Wave Solder Operations for through-hole mounted products (THMT)

For Sn/Ag/Cu based solders:

Maximum Preheat Temperature	115° C.
Maximum Pot Temperature	270° C.
Maximum Solder Dwell Time	7 seconds

For Sn/Pb based solders:

Maximum Preheat Temperature	105° C.
Maximum Pot Temperature	250° C.
Maximum Solder Dwell Time	6 seconds

Start-Up Threshold and Undervoltage Shutdown

Under normal start-up conditions, devices will not begin to regulate until the ramping-up input voltage exceeds the Start-Up Threshold Voltage (35V for "D48A" models). Once operating, devices will not turn off until the input voltage drops below the Undervoltage Shutdown/Lockout limit (34V for "D48A" models). Subsequent re-start will not occur until the input is brought back up to the Start-Up Threshold. This built-in hysteresis obviously avoids any indeterminate on/off situations at a single voltage.

Start-Up Time

The V_{IN} to V_{OUT} Start-Up Time is the interval between the time at which a ramping input voltage crosses the turn-on threshold point and the fully-loaded output voltage enters and remains within its specified accuracy band. Actual measured times will vary with input source impedance, external input capacitance, and the slew rate and final value of the input voltage as it appears to the converter.

The On/Off to V_{OUT} Start-Up Time assumes the converter is turned off via the On/Off Control with the nominal input voltage already applied to the converter. The specification defines the interval between the time at which the converter is turned on and the fully-loaded output voltage enters and remains within its specified accuracy band.

Accuracy of adjustment is subject to tolerances or resistor values and factory-adjusted output accuracy. V_O = desired output voltage.

Temperature Derating Curves for UWR 7-15W A-Series

The thermal performance of A-Series UWR 7-15 Watt DC/DC Converters is depicted in the derating curves shown below. All devices, when operated at full load, in still ambient air, over their full specified input voltage range, can safely operate to T_A maximum. All models, other than the D12A models (10-18 Volt input range), can operate at higher ambient temperatures if the input range is narrowed. For example, model UWR-5/3000-D48A can operate safely to $+70^\circ\text{C}$ if the input range is kept between 36 and 48 Volts.

D12A (10-18V) Temperature Derating

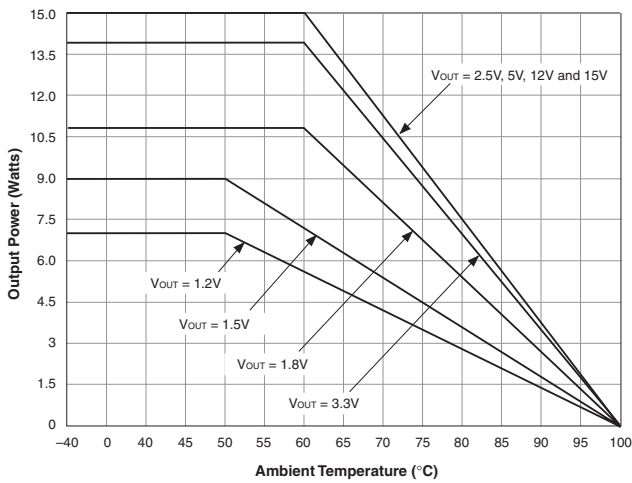

D24A and D48A Temperature Derating for 2.5/5/12/15V Output Models

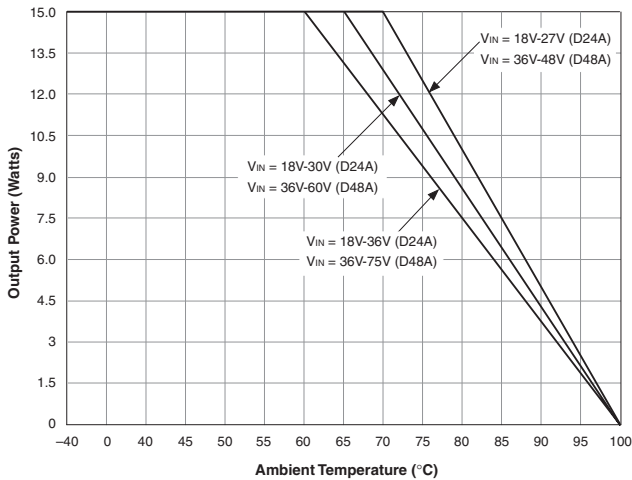

D24A and D48A Temperature Derating for 1.5V Output Models

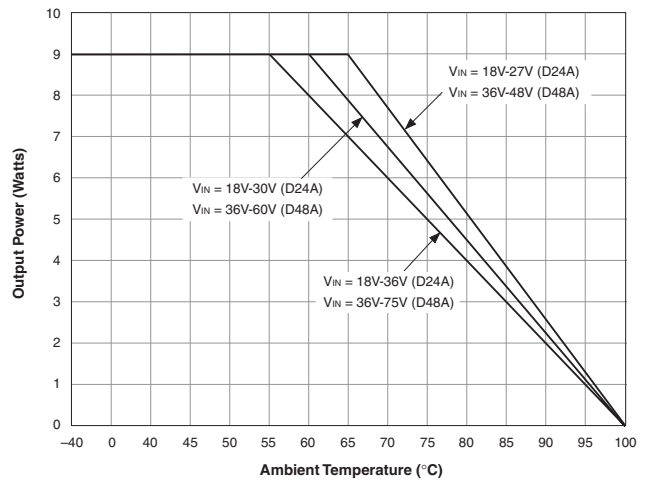

D24A and D48A Temperature Derating for 1.8V Output Models

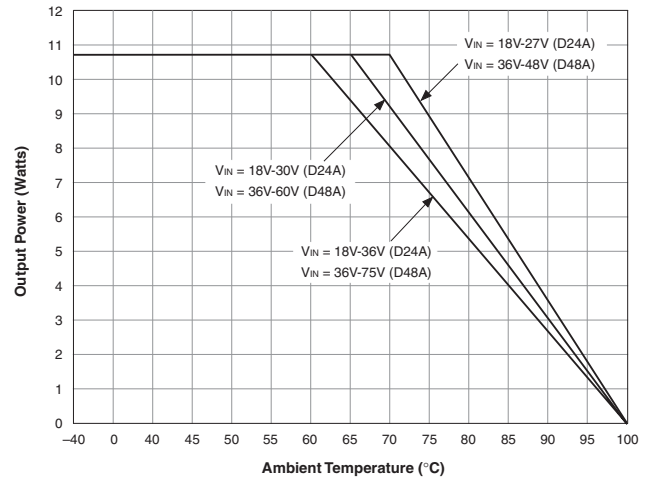

D24A and D48A Temperature Derating for 3.3V Output Models

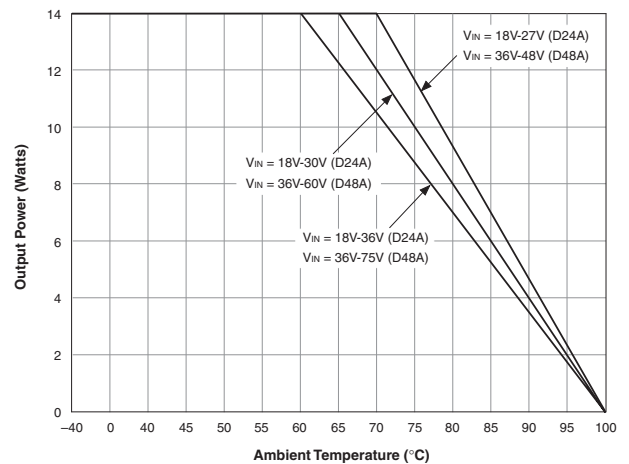

Typical Performance Curves for UWR 7-15W A-Series

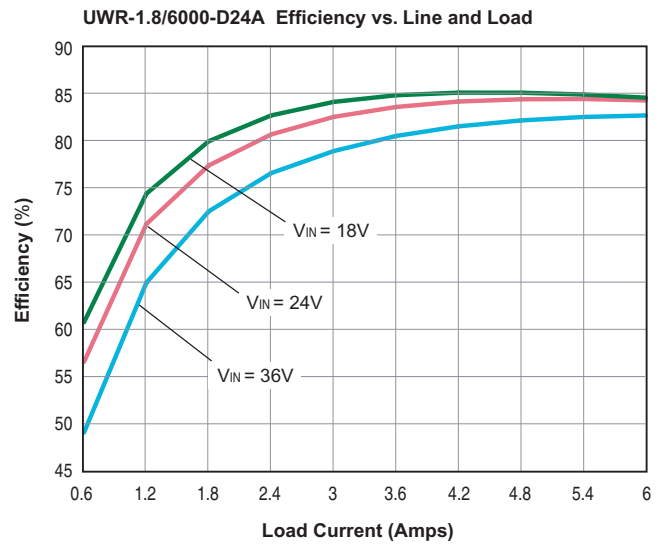
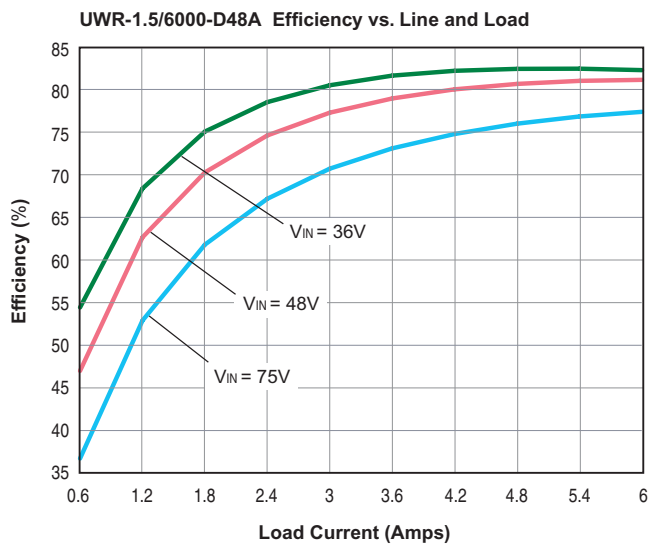
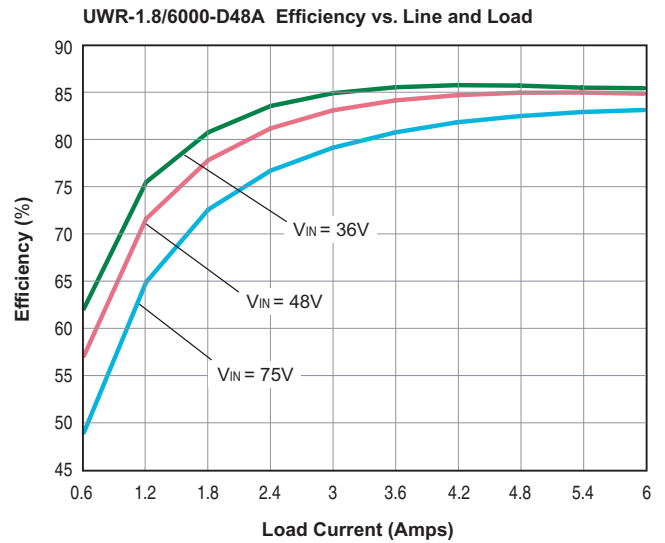
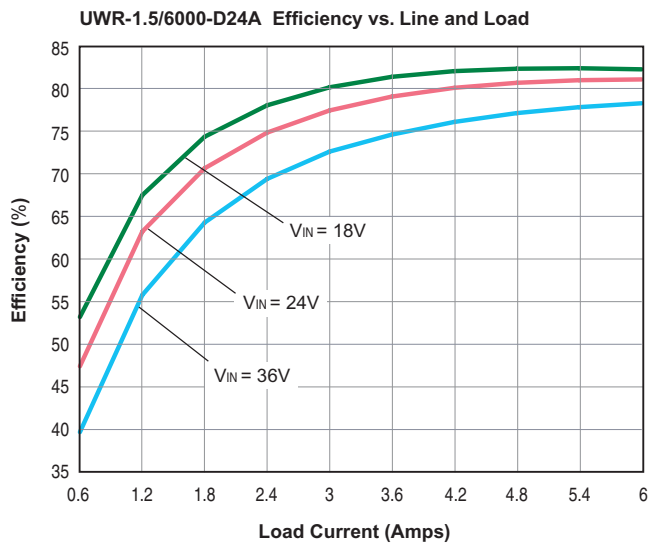
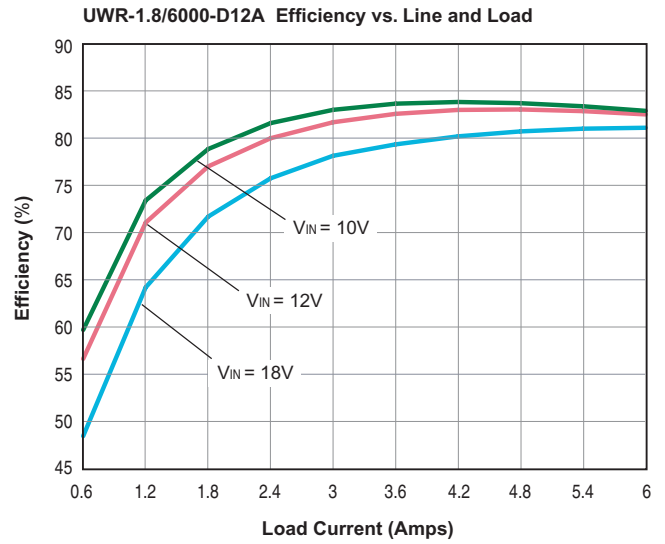
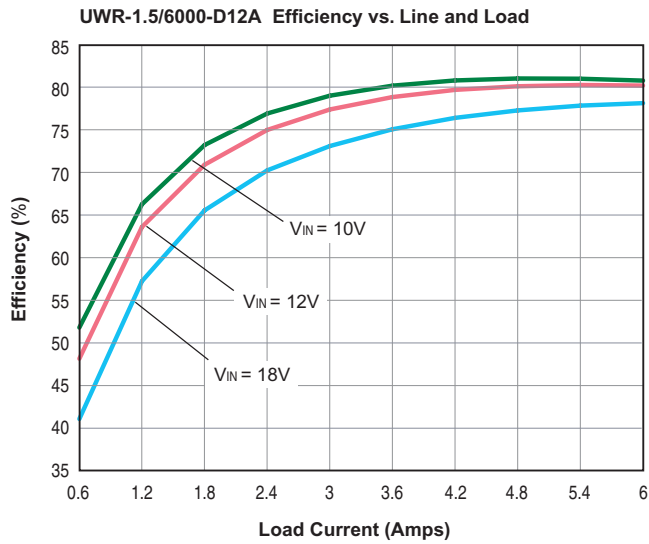

Typical Performance Curves for UWR 7-15W A-Series

UWR-2.5/6000-D12A Efficiency vs. Line and Load

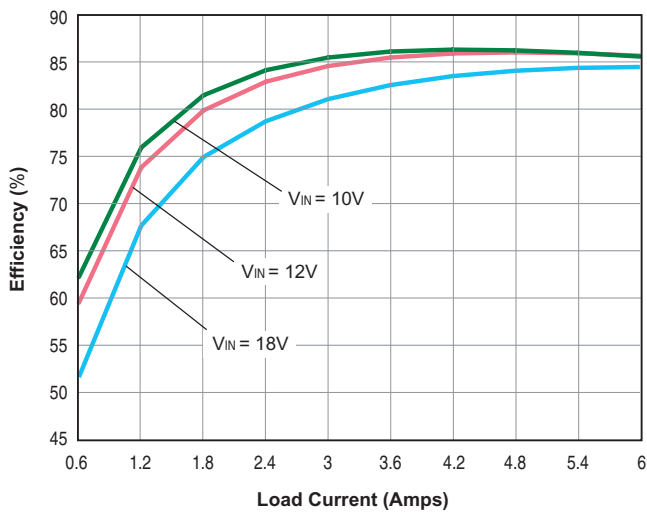

UWR-3.3/4250-D12A Efficiency vs. Line and Load

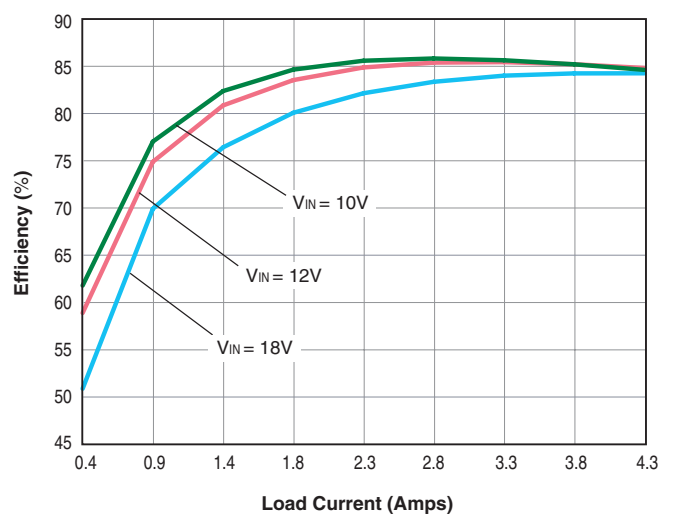

UWR-2.5/6000-D24A Efficiency vs. Line and Load

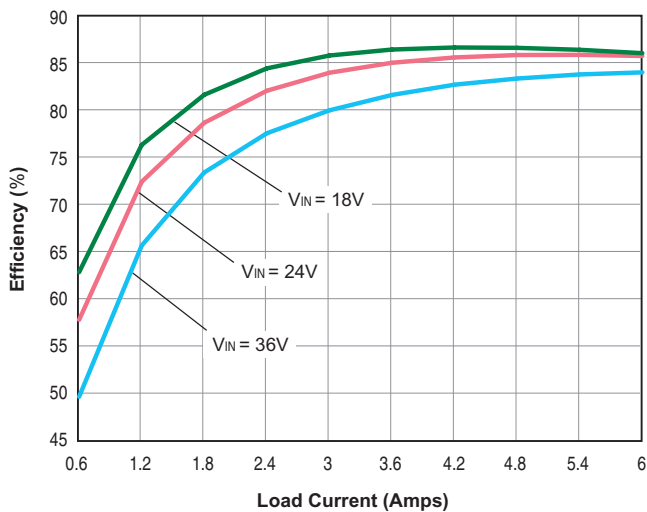

UWR-3.3/4250-D24A Efficiency vs. Line and Load

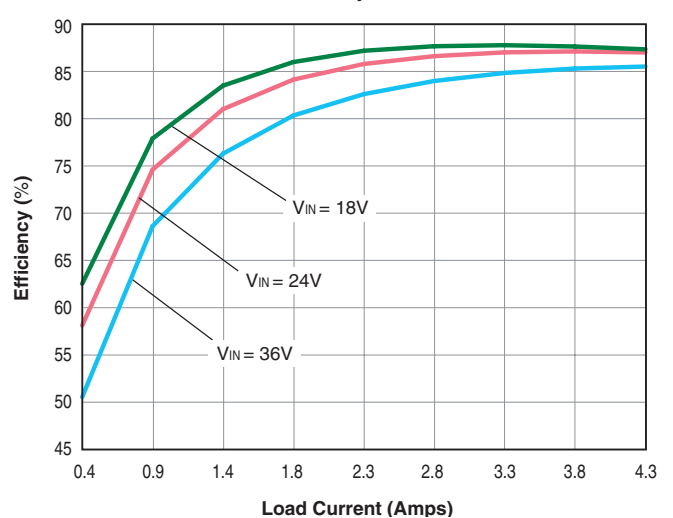

UWR-2.5/6000-D48A Efficiency vs. Line and Load

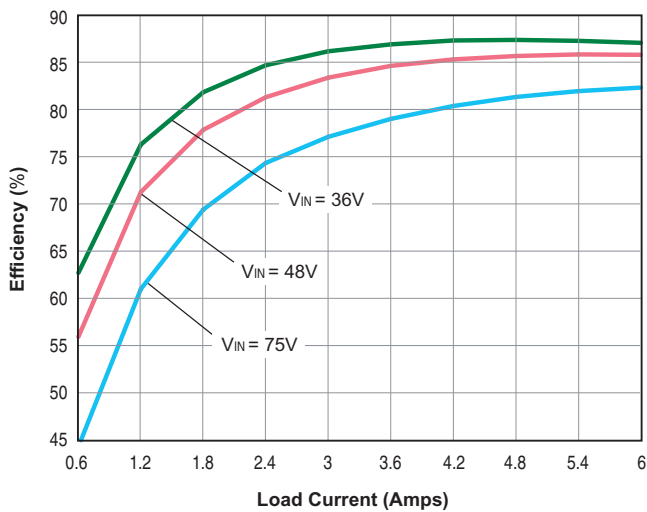

UWR-3.3/4250-D48A Efficiency vs. Line and Load

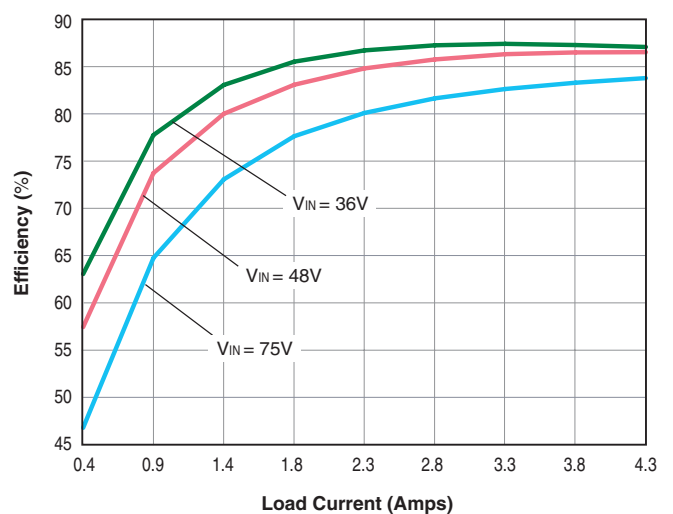

Typical Performance Curves for UWR 7-15W A-Series

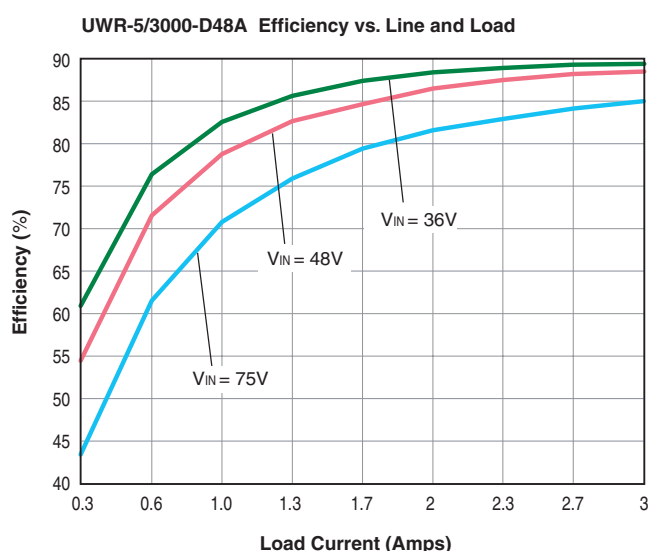
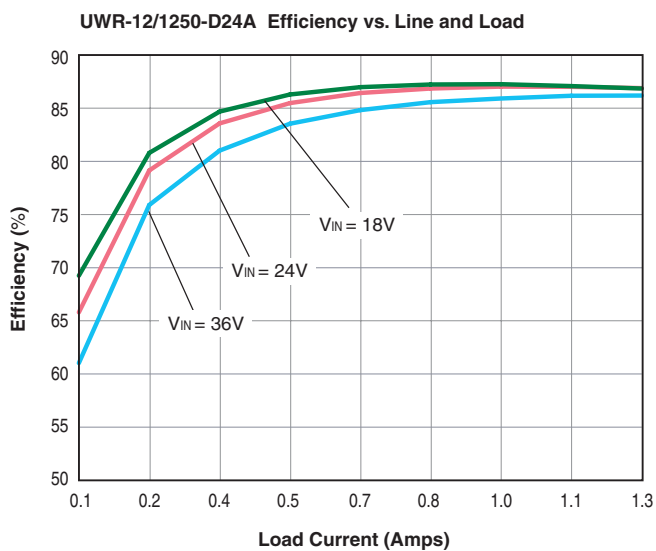
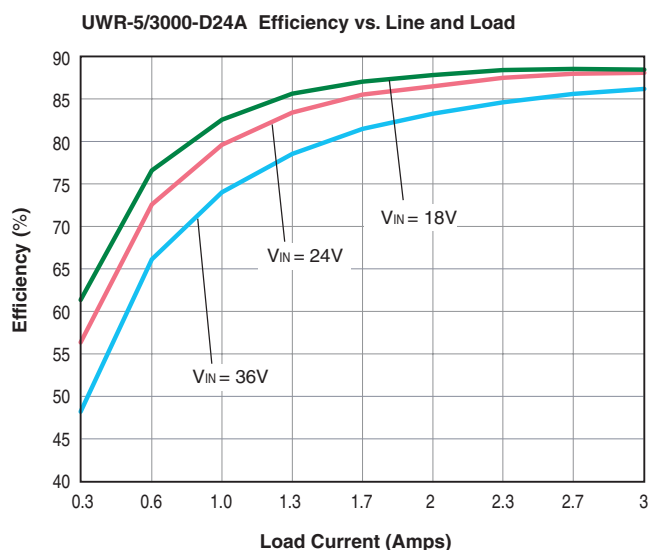
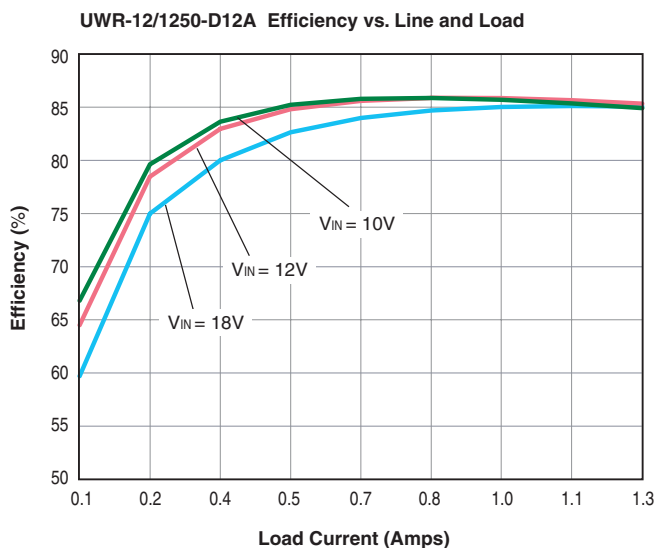
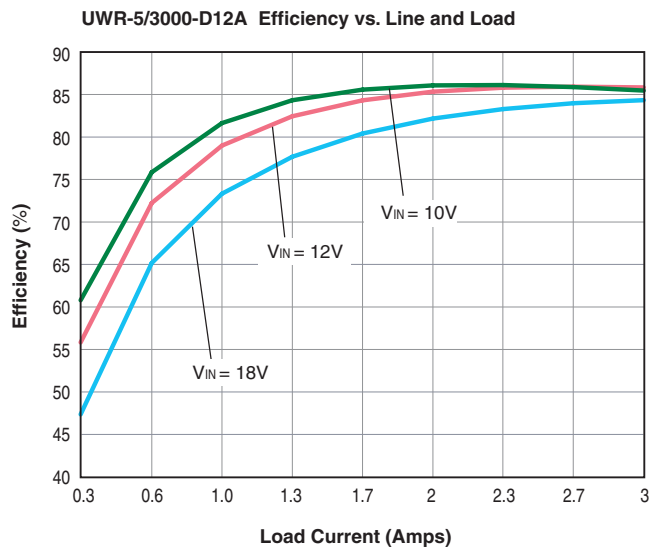
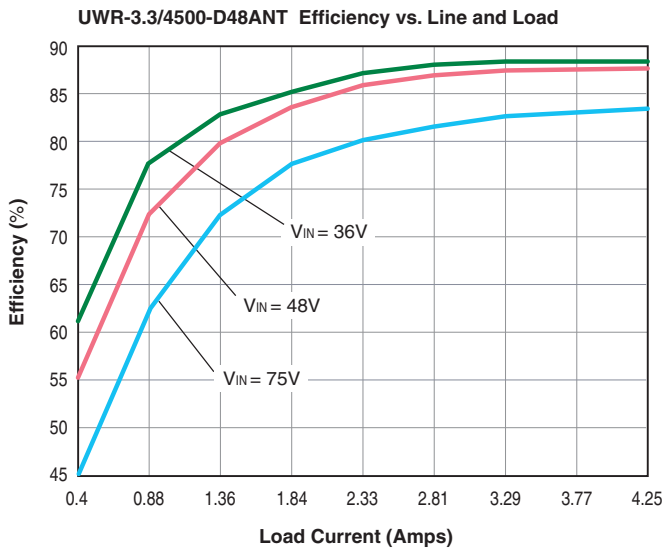

Typical Performance Curves for UWR 7-15W A-Series

UWR-12/1250-D48A Efficiency vs. Line and Load

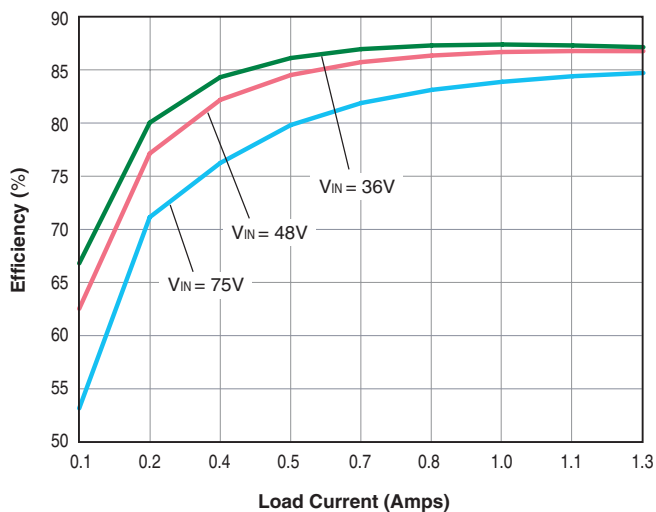

UWR-15/1000-D48A Efficiency vs. Line and Load

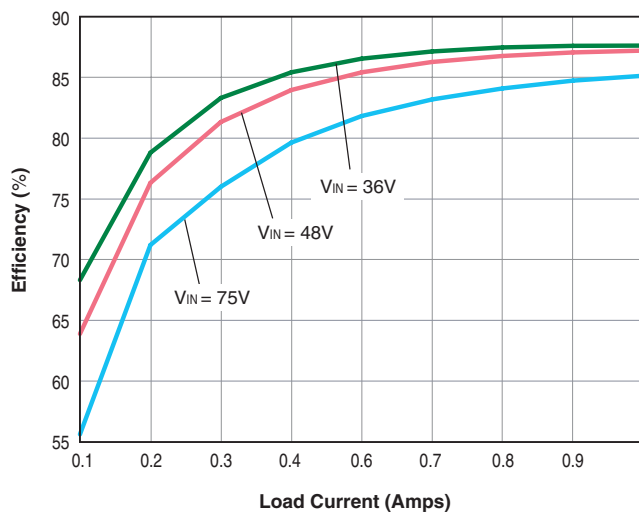

UWR-15/1000-D12A Efficiency vs. Line and Load

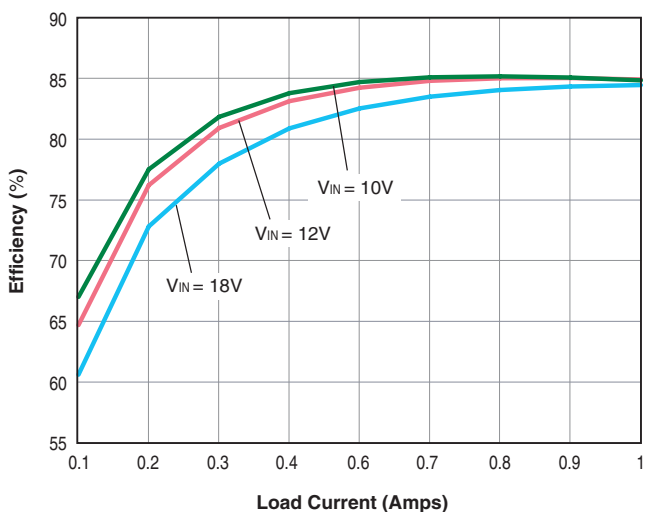

UWR-15/1000-D24A Efficiency vs. Line and Load

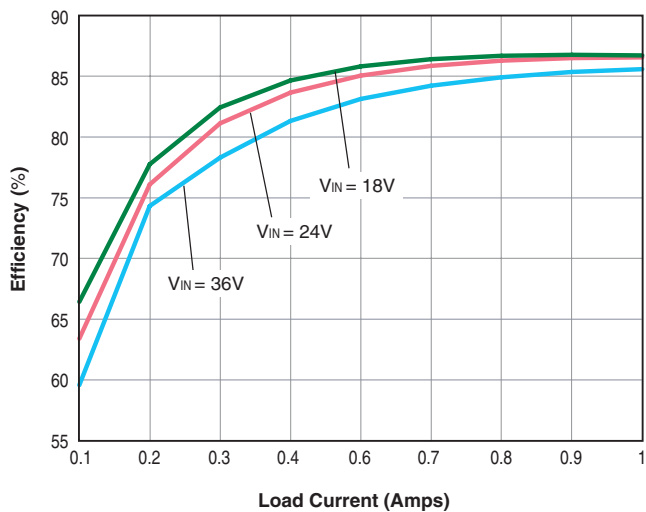

Output Ripple and Noise (PARD)

(VIN = nominal, VOUT = 1.5V @ 6A, two external 0.47μF output capacitors.)

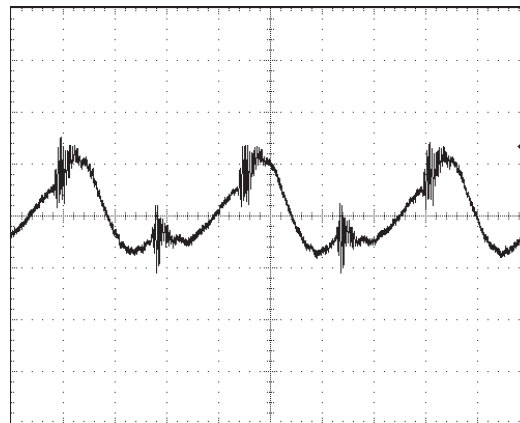

20mV, 1μsec/div, 20MHz BW

Output Ripple and Noise (PARD)

(VIN = nominal, VOUT = 1.8V @ 6A, two external 0.47μF output capacitors.)

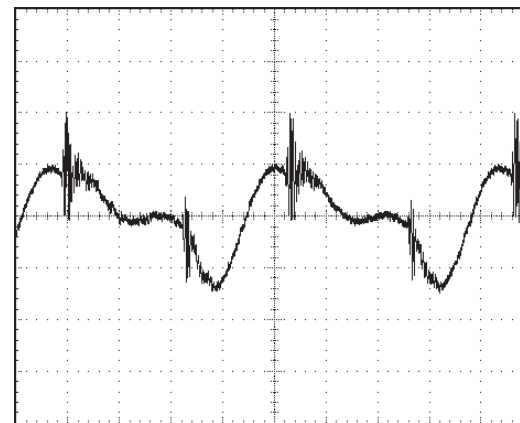

20mV, 1μsec/div, 20MHz BW

Typical Performance Curves for UWR 7-15W A-Series

Output Ripple and Noise (PARD)

(VIN = nominal, VOUT = 2.5V @ 6A, two external 0.47μF output capacitors.)

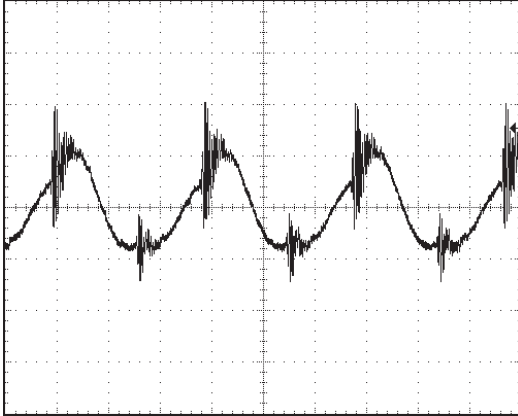

20mV, 1μsec/div, 20MHz BW

Output Ripple and Noise (PARD)

(VIN = nominal, VOUT = 12V @ 1.25A, two ext. 0.47μF output capacitors.)

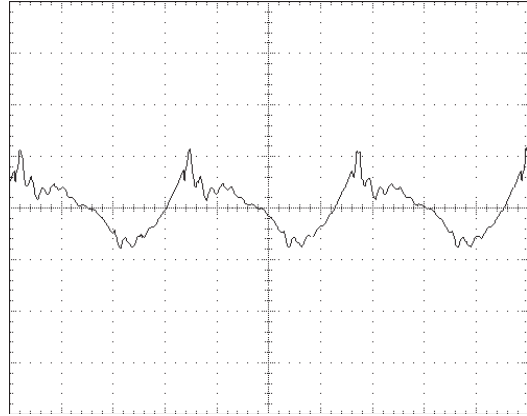

20mV, 1μsec/div, 20MHz BW

Output Ripple and Noise (PARD)

(VIN = nominal, VOUT = 3.3V @ 4.25A, two ext. 0.47μF output capacitors.)

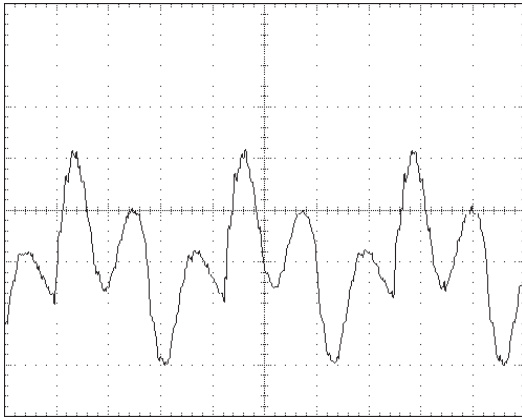

20mV, 1μsec/div, 20MHz BW

Output Ripple and Noise (PARD)

(VIN = nominal, VOUT = 15V @ 1A, two external 0.47μF output capacitors.)

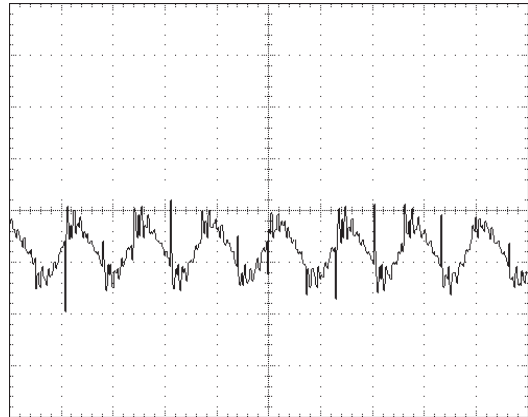

20mV, 2.5μsec/div, 20MHz BW

Output Ripple and Noise (PARD)

(VIN = nominal, VOUT = 5V @ 3A, two external 0.47μF output capacitors.)

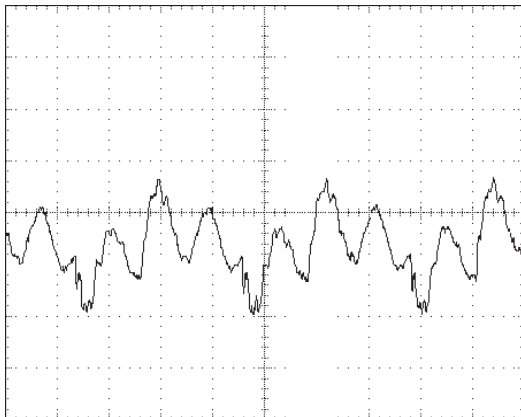

20mV, 1μsec/div, 20MHz BW

PART NUMBER STRUCTURE

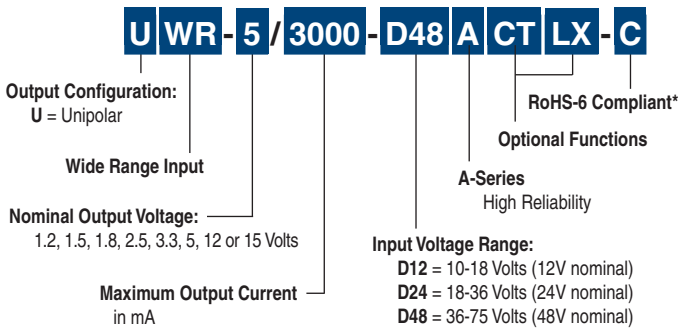

*Note: Not all model number combinations may be available. Contact MPS.

Optional Functions

The A-Series 7-15W DC/DC Converters offer numerous electrical/ mechanical options. Per the Ordering Guide on page 2, the trailing "A" (A-Series) in each part number pertains to the base part number. Part-number suffixes are added after the "A," indicating the selection of standard options. The resulting part number is a "standard product" and is available to any customer desiring that particular combination of options. As described below, selecting certain options will result in the installation of additional pins in certain locations.

Suffix	Description
Blank	No V_{OUT} Trim or On/Off Control functions added (no I/O pins installed in the pin 3 and pin 5 positions). The pin length remains at 0.2 inches (5.08 mm).
T	Add a V_{OUT} Trim function on pin 5. No pin 3 installed.
C	Add an On/Off Control function on pin 3 (with positive polarity). No pin 5 installed.
CT	Add the On/Off Control function (with positive polarity) on pin 3 and add the V_{OUT} trim function on pin 5.
N	Add an On/Off Control function on pin 3 with negative polarity. No pin 5 installed.
NT	Add the On/Off Control function with negative polarity on pin 3 and add the V_{OUT} trim function on pin 5.
L1	Trim the pin length to 0.110 \pm 0.010 inches (2.79 \pm 0.25mm). This option requires a minimum order quantity.

L2 Trim the pin length to 0.145 \pm 0.010 inches (3.68 \pm 0.25mm). This option requires a minimum order quantity.

-C RoHS-6 hazardous substance compliance (does not claim EU RoHS exemption 7b, lead in solder).

* Note: Usage of consecutive "C" and "-C" designations is correct for some models. Example: UWR-5/3000-D48AC-C

Adaptations

There are various additional configurations available on A-Series 7-15W DC/DCs. Because designating each of them with a standard part-number suffix would result in an unmanageable matrix of part numbers, such are designated by MPS and assigned 5-digit "part-number suffixes.

UWR-3.3/4250-D48AT-30690

Standard product, 48V_{IN}, 3.3V_{OUT}/4.25A with a V_{OUT} Trim function added in the pin 3 position, with adapted current limit set point to 6.5A min. and with removed Input Overvoltage Shutdown function.

UWR-5/3000-D48ACT-30770

UWR-5/3000-D48ACT-30770-Y (RoHS-5)

Standard product, 48V_{IN}, 5V_{OUT}/3A. On/Off Control function (positive polarity) on pin 3, V_{OUT} Trim function added on pin 5. Adaptations: Trim equations are Tyco/Lucent-compatible. Transformer isolation system has been enhanced to meet the **basic insulation** requirements of UL60950-1/EN60950-1. I/O pins are 25-mil-square Tyco/Lucent compatible. Shielded metal case is connected to +V_{IN} pin 1. Input Overvoltage Shutdown function has been removed.

UWR-3.3/4500-D48ANT

Standard UWR-3.3/4250-D48A, 48V_{IN}, 3.3V_{OUT} with slightly higher output current (4.5A), negative on/off polarity control and a special competitive-compatible trim.

UWR-3.3/4500-D48ANT accepts trim adjustments to \pm 10% of nominal V_{OUT} not to exceed 15W of maximum output power. Users should carefully consider the amount of trim added since excessive positive trim may exceed the overvoltage protection. Excessive negative trim may interfere with proper regulation.

UWR-3.3/4500-D48ANST Special trim version. See page 5.

UWR-5/3000-D48ANSTHL2-Y

UWR-3.3/4500-D48ANTHL2-Y

Negative on/off polarity, special trim, conformal coating added, 3.68mm pin length, RoHS-5 compliance (with lead). RoHS-5 compliance requires a scheduled quantity order. Not all RoHS-5 "-Y" models are available. Please contact Product Marketing for further information.

I/O Connections			
Pin	Function P22	Pin	Function P22
1	+Vin	4	+Vout
2	-Vin	5	Trim*
3	On/Off Control*	6	Common

Dimensions are in inches (mm) shown for ref. only.

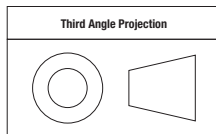

Tolerances (unless otherwise specified):
 .XX ± 0.02 (0.5)
 .XXX ± 0.010 (0.25)
 Angles ± 2°

Components are shown for reference only.

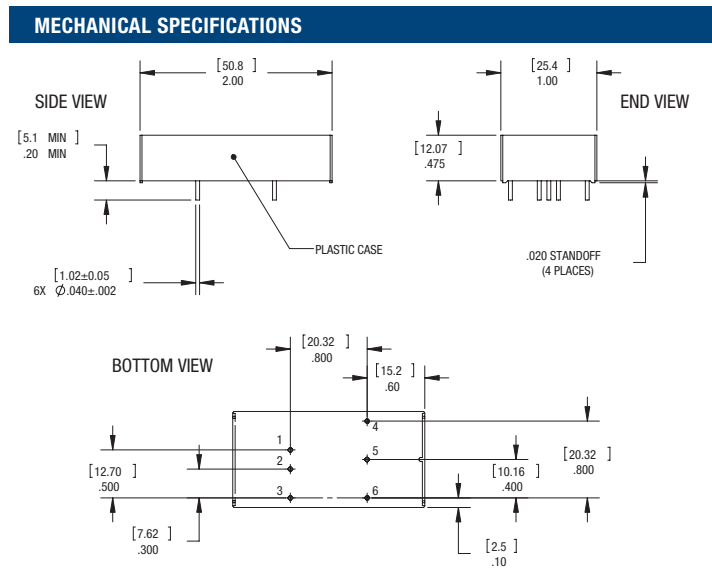

*Pins 3 and 5 are optional.
See Optional Functions and Technical Notes for details.

Standard pin length is shown.
Please refer to the Part Number Structure for special order pin lengths.



Looking for pricing, stock, or lifecycle information?

Click below to explore more details on WIN SOURCE:

-  [View UWR-3.3/4250-D24ACT-C on WIN SOURCE](#)
-  [Murata Power Solutions Inc. Information](#)

Optimize Your Supply Chain with WIN SOURCE Solutions

-  Global Sourcing Solution
-  Obsolete Management
-  Cost Control Management
-  Shortage Management
-  Alternative Solution
-  Excess Inventory Management