

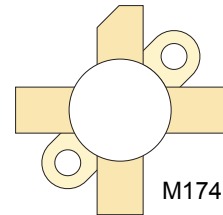

RF POWER VERTICAL MOSFET

The VRF150 is a gold-metallized silicon n-channel RF power transistor designed for broadband commercial and military applications requiring high power and gain without compromising reliability, ruggedness, or inter-modulation distortion.



FEATURES

- Improved Ruggedness $V_{(BR)DSS} = 170V$
- 150W with 11dB Typical Gain @ 150MHz, 50V
- 150W with 18dB Typical Gain @ 30MHz, 50V
- Excellent Stability & Low IMD
- Common Source Configuration
- Available in Matched Pairs
- 70:1 Load VSWR Capability at Specified Operating Conditions
- Nitride Passivated
- Refractory Gold Metallization
- High Voltage Replacement for MRF150
- RoHS Compliant 

Maximum Ratings

All Ratings: $T_c = 25^\circ C$ unless otherwise specified

Symbol	Parameter	VRF150(MP)	Unit
V_{DSS}	Drain-Source Voltage	170	V
I_D	Continuous Drain Current @ $T_c = 25^\circ C$	16	A
V_{GS}	Gate-Source Voltage	± 40	V
P_D	Total Device dissipation @ $T_c = 25^\circ C$	300	W
T_{STG}	Storage Temperature Range	-65 to 150	$^\circ C$
T_J	Operating Junction Temperature	200	

Static Electrical Characteristics

Symbol	Parameter	Min	Typ	Max	Unit
$V_{(BR)DSS}$	Drain-Source Breakdown Voltage ($V_{GS} = 0V, I_D = 100mA$)	170	180		V
$V_{DS(ON)}$	On State Drain Voltage ($I_{D(ON)} = 10A, V_{GS} = 10V$)		2.0	3.0	
I_{DSS}	Zero Gate Voltage Drain Current ($V_{DS} = 100V, V_{GS} = 0V$)			1.0	mA
I_{GSS}	Gate-Source Leakage Current ($V_{GS} = \pm 20V, V_{DS} = 0V$)			1.0	μA
g_{fs}	Forward Transconductance ($V_{DS} = 10V, I_D = 5A$)	4.5			mhos
$V_{GS(TH)}$	Gate Threshold Voltage ($V_{DS} = 10V, I_D = 100mA$)	2.9	3.6	4.4	V

Thermal Characteristics

Symbol	Characteristic	Min	Typ	Max	Unit
$R_{\theta JC}$	Junction to Case Thermal Resistance			0.60	$^\circ C/W$

 **CAUTION:** These Devices are Sensitive to Electrostatic Discharge. Proper Handling Procedures Should Be Followed.

Dynamic Characteristics

VRF150(MP)

Symbol	Parameter	Test Conditions	Min	Typ	Max	Unit
C_{iss}	Input Capacitance	$V_{GS} = 0V$ $V_{DS} = 50V$ $f = 1MHz$		420		pF
C_{oss}	Output Capacitance			210		
C_{rss}	Reverse Transfer Capacitance			35		

Functional Characteristics

Symbol	Parameter	Min	Typ	Max	Unit
G_{PS}	$f_1 = 30MHz, f_2 = 30.001MHz, V_{DD} = 50V, I_{DQ} = 250mA, P_{out} = 150W_{PEP}^1$		18		dB
G_{PS}	$f = 150MHz, V_{DD} = 50V, I_{DQ} = 250mA, P_{out} = 150W$		11		
η_D	$f_1 = 30MHz, f_2 = 30.001MHz, V_{DD} = 50V, I_{DQ} = 250mA, P_{out} = 150W_{PEP}^1$		50		%
IMD _(d3)	$f_1 = 30MHz, f_2 = 30.001MHz, V_{DD} = 50V, I_{DQ} = 250mA, P_{out} = 150W_{PEP}^1$		-32		dBc
ψ	$f_1 = 30MHz, V_{DD} = 50V, I_{DQ} = 250mA, P_{out} = 150W$ CW 70:1 VSWR - All Phase Angles, 0.2mSec X 20% Duty Factor	No Degradation in Output Power			

Class A Characteristics

Symbol	Test Conditions	Min	Typ	Max	Unit
G_{PS}	$V_{DD} = 50V, I_{DQ} = 3A, P_{out} = 150W_{PEP}, f_1 = 30MHz, f_2 = 30.001MHz$		20		dB
IMD _(d3)			-50		
IMD _(d9-d13)			-75		

1. To MIL-STD-1311 Version A, test method 2204B, Two Tone, Reference Each Tone

Microsemi reserves the right to change, without notice, the specifications and information contained herein.

Typical Performance Curves

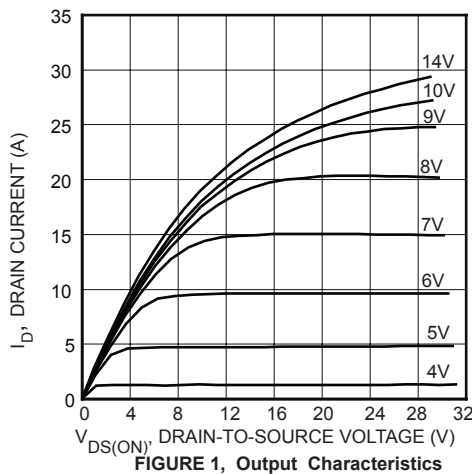

FIGURE 1, Output Characteristics

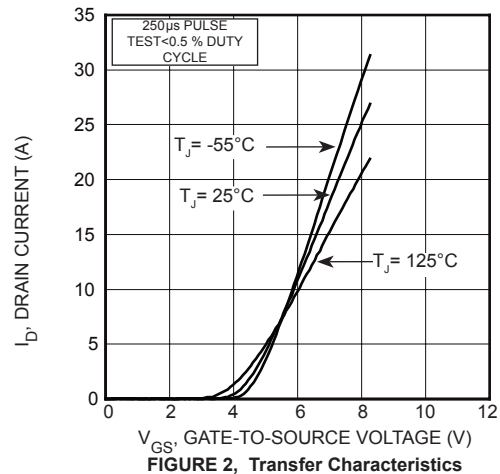

FIGURE 2, Transfer Characteristics

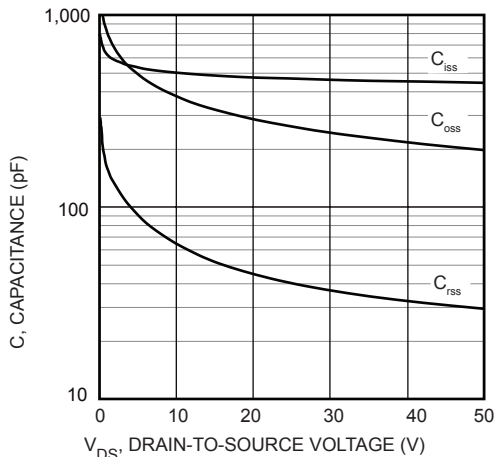

FIGURE 3, Capacitance vs Drain-to-Source Voltage

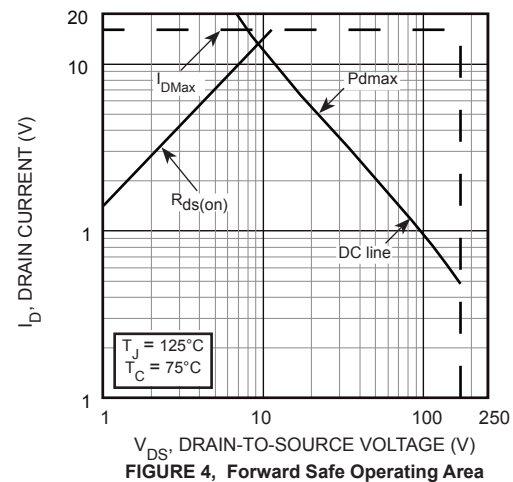

FIGURE 4, Forward Safe Operating Area

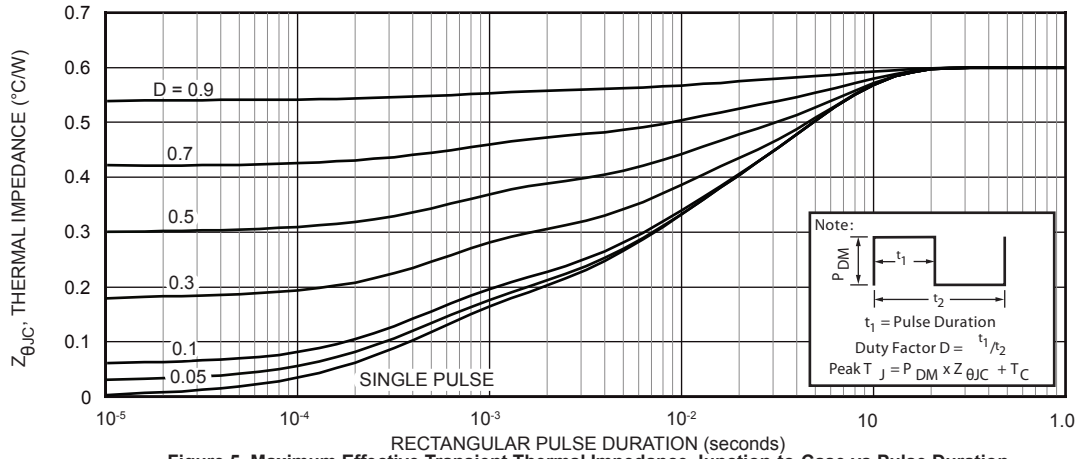

Figure 5. Maximum Effective Transient Thermal Impedance Junction-to-Case vs Pulse Duration

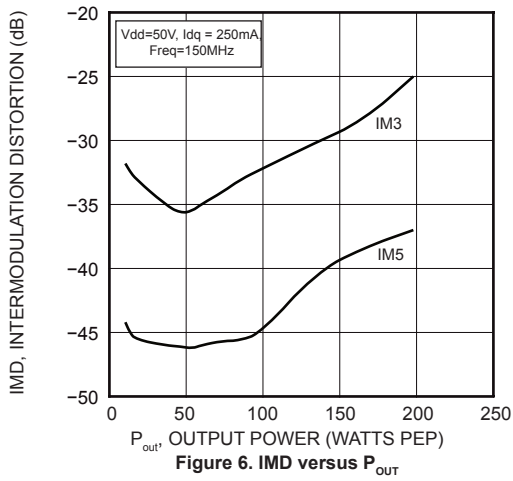

Figure 6. IMD versus P_{OUT}

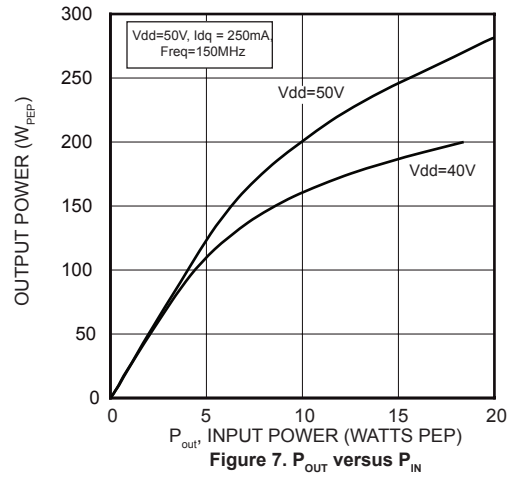
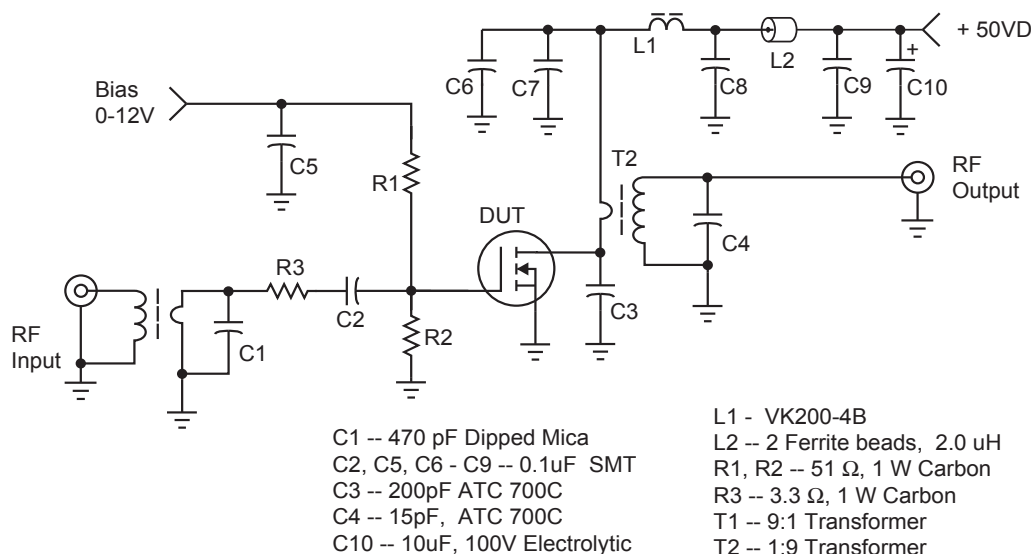
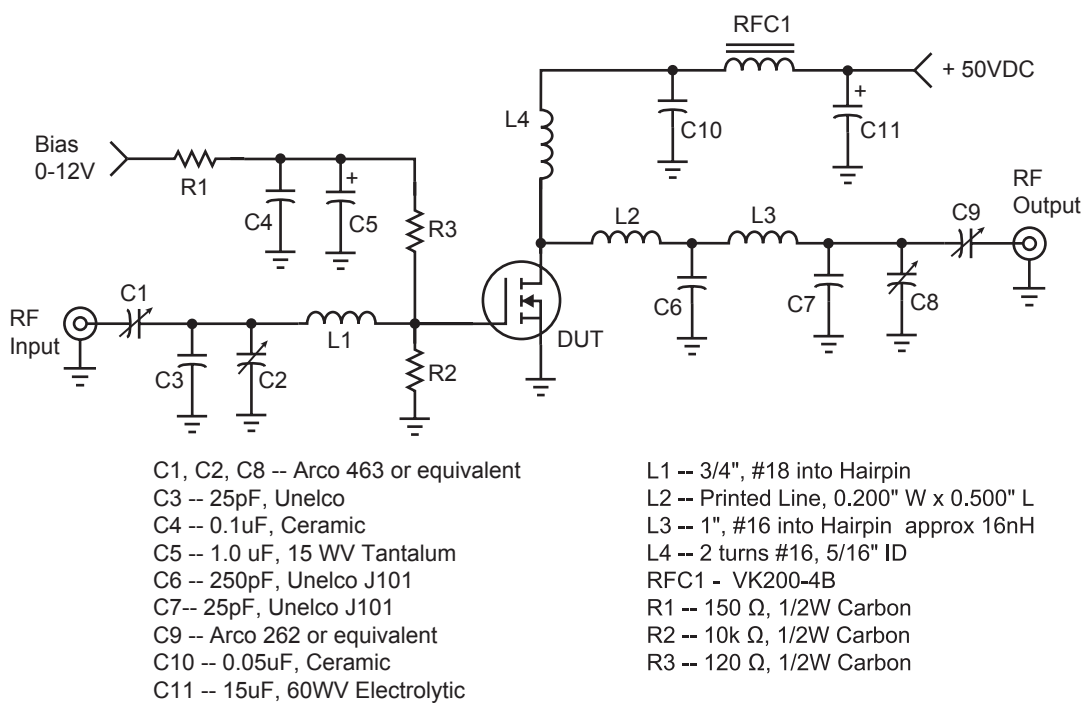

Figure 7. P_{OUT} versus P_{IN}

30 MHz test Circuit



150 MHz test Circuit



Adding MP at the end of P/N specifies a matched pair where $V_{GS(TH)}$ is matched between the two parts. V_{TH} values are marked on the devices per the following table.

Code	Vth Range	Code 2	Vth Range
A	2.900 - 2.975	M	3.650 - 3.725
B	2.975 - 3.050	N	3.725 - 3.800
C	3.050 - 3.125	P	3.800 - 3.875
D	3.125 - 3.200	R	3.875 - 3.950
E	3.200 - 3.275	S	3.950 - 4.025
F	3.275 - 3.350	T	4.025 - 4.100
G	3.350 - 3.425	W	4.100 - 4.175
H	3.425 - 3.500	X	4.175 - 4.250
J	3.500 - 3.575	Y	4.250 - 4.325
K	3.575 - 3.650	Z	4.325 - 4.400

V_{TH} values are based on Microsemi measurements at datasheet conditions with an accuracy of 1.0%.

.5" SOE Package Outline
All Dimensions are $\pm .005$

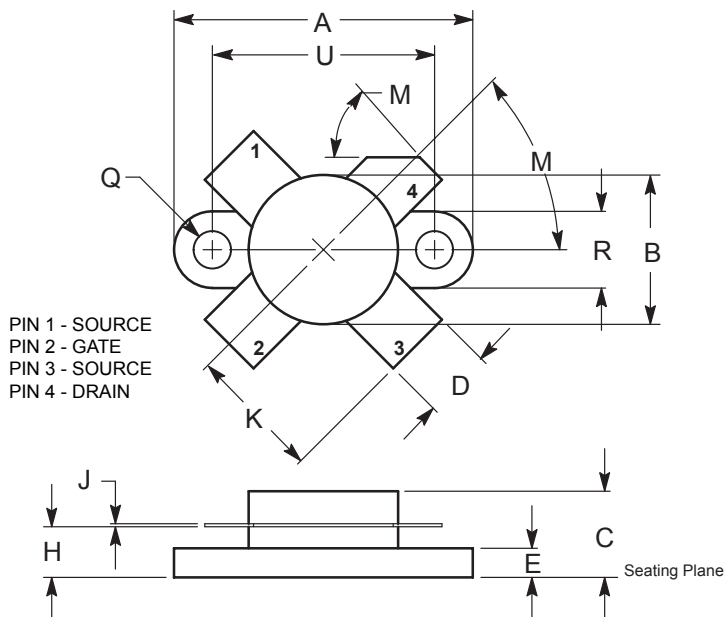



DIM	INCHES		MILLIMETERS	
	MIN	MAX	MIN	MAX
A	0.096	0.990	24.39	25.14
B	0.465	0.510	11.82	12.95
C	0.229	0.275	5.82	6.98
D	0.216	0.235	5.49	5.96
E	0.084	0.110	2.14	2.79
H	0.144	0.178	3.66	4.52
J	0.003	0.007	0.08	0.17
K	0.435		11.0	
M	45° NOM		45° NOM	
Q	0.115	0.130	2.93	3.30
R	0.246	0.255	6.25	6.47
U	0.720	0.730	18.29	18.54

The information contained in the document (unless it is publicly available on the Web without access restrictions) is PROPRIETARY AND CONFIDENTIAL information of Microsemi and cannot be copied, published, uploaded, posted, transmitted, distributed or disclosed or used without the express duly signed written consent of Microsemi. If the recipient of this document has entered into a disclosure agreement with Microsemi, then the terms of such Agreement will also apply. This document and the information contained herein may not be modified, by any person other than authorized personnel of Microsemi. No license under any patent, copyright, trade secret or other intellectual property right is granted to or conferred upon you by disclosure or delivery of the information, either expressly, by implication, inducement, estoppels or otherwise. Any license under such intellectual property rights must be approved by Microsemi in writing signed by an officer of Microsemi.

Microsemi reserves the right to change the configuration, functionality and performance of its products at anytime without any notice. This product has been subject to limited testing and should not be used in conjunction with life-support or other mission-critical equipment or applications. Microsemi assumes no liability whatsoever, and Microsemi disclaims any express or implied warranty, relating to sale and/or use of Microsemi products including liability or warranties relating to fitness for a particular purpose, merchantability, or infringement of any patent, copyright or other intellectual property right. Any performance specifications believed to be reliable but are not verified and customer or user must conduct and complete all performance and other testing of this product as well as any user or customers final application. User or customer shall not rely on any data and performance specifications or parameters provided by Microsemi. It is the customer's and user's responsibility to independently determine suitability of any Microsemi product and to test and verify the same. The information contained herein is provided "AS IS, WHERE IS" and with all faults, and the entire risk associated with such information is entirely with the User. Microsemi specifically disclaims any liability of any kind including for consequential, incidental and punitive damages as well as lost profit. The product is subject to other terms and conditions which can be located on the web at <http://www.microsemi.com/legal/tnc.asp>

Looking for pricing, stock, or lifecycle information?

Click below to explore more details on WIN SOURCE:

-  [View VRF150 on WIN SOURCE](#)
-  [Microchip Technology](#) Information

Optimize Your Supply Chain with WIN SOURCE Solutions

-  Global Sourcing Solution
-  Obsolete Management
-  Cost Control Management
-  Shortage Management
-  Alternative Solution
-  Excess Inventory Management