



**THE DATASHEET OF
0HEV010.ZXBD**





Low Current HEV Fuses



OHEV040.ZXBD

Low Current HEV Fuse

The LC HEV fuse is designed for protection of high-voltage accessory circuits in electric and hybrid electric vehicles.

Specifications

Voltage Rating (10A, 15A, 20A, 30A):	450 VDC
Voltage Rating (40A):	425 VDC
Note: The OHEV040.ZXBD is rated at 450 VDC	
Interrupting Rating (10A, 15A, 20A, 30A):	10kA @ 450 VDC
Interrupting Rating (40A):	10kA @ 425 VDC
Operating Temperature Range:	-40°C to +125°C

Ordering Information

Part Number	Termination	Package Size	% of Rating	Opening Time Min / Max (s) 10A	Opening Time Min / Max (s) 15A, 20A, 30A	Opening Time Min / Max (s) 40A
OHEVxxx.ZXC	Cartridge	240	100	100 hrs / -	100 hrs / -	100 hrs / -
OHEVxxx.ZXISO	Bolt Down (ISO)	240	110	4 hrs / -	4 hrs / -	-
OHEVxxx.ZXPY	Blade	240	135	100 / 3600	150 / 3600	150 / 3600
OHEVxxx.ZXBD	Bolt Down (Axial)	240	150	10 / 1000	10 / 1000	10 / 1000
OHEVxxx.ZXPCB	PCB Mount	240	200	0.5 / 100	0.5 / 100	0.5 / 100
OHEVxxx.ZXPCBL	PCB Mount (Long)	240	300	0.1 / 15	0.1 / 15	0.1 / 15
			500	0.05 / 1	0.05 / 1	0.05 / 1

Time-Current Characteristics

Ratings

Part Number	Current Rating (A)	Color Code	Typical Voltage Drop at 70% I _R (mV)	Maximum Voltage Drop Spec at 100% IR (mV)	Typical Cold Resistance (mΩ)	Minimum Melting I ² t (A ² s)
OHEV010.xxx	10	Red	114	300	12.8	255
OHEV015.xxx	15	Blue	96	200	7.9	133
OHEV020.xxx	20	Yellow	79	200	5.0	268
OHEV030.xxx	30	Green	67	200	2.7	993
OHEV040.xxx	40	Orange	69	200	2.0	1495

(Average Initial Measurements)

Time-Current Characteristic Curves

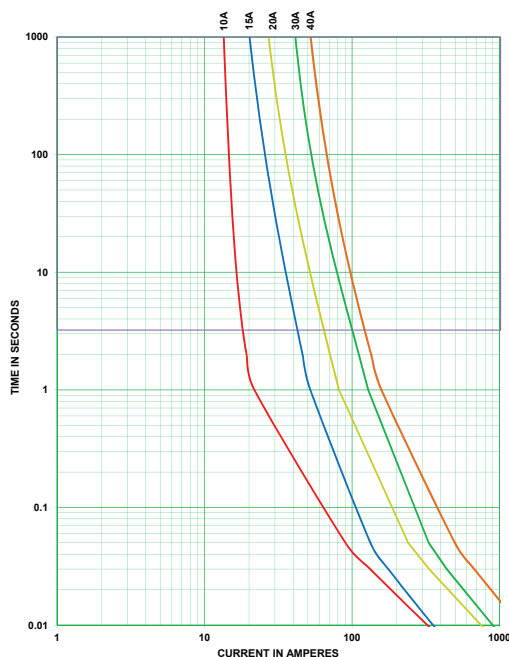

Temperature Derating Curve

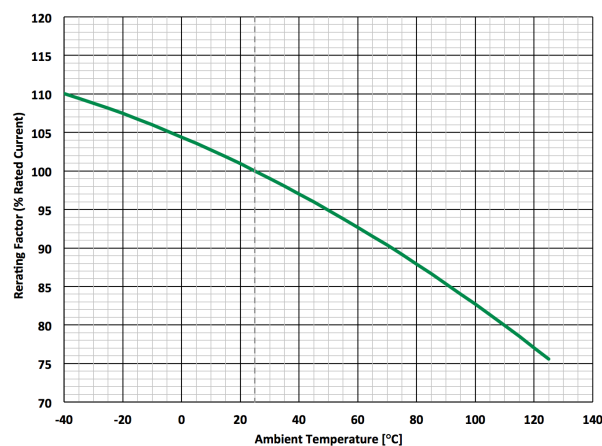

Littelfuse products are not designed for, and shall not be used for, any purpose (including, without limitation, automotive, military, aerospace, medical, life-saving, life-sustaining or nuclear facility applications, devices intended for surgical implant into the body, or any other application in which the failure or lack of desired operation of the product may result in personal injury, death, or property damage) other than those expressly set forth in applicable Littelfuse product documentation. Warranties granted by Littelfuse shall be deemed void for products used for any purpose not expressly set forth in applicable Littelfuse documentation. Littelfuse shall not be liable for any claims or damages arising out of products used in applications not expressly intended by Littelfuse as set forth in applicable Littelfuse documentation. The sale and use of Littelfuse products is subject to Littelfuse Terms and Conditions of Sale, unless otherwise agreed by Littelfuse.

Low Current HEV Fuse

Dimensions

Dimensions in mm

ZXC Cartridge

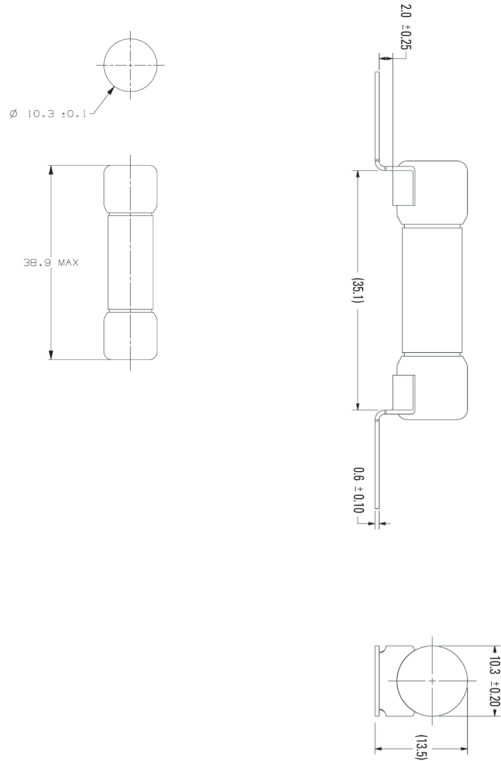

ZXISO Bolt Down (ISO)

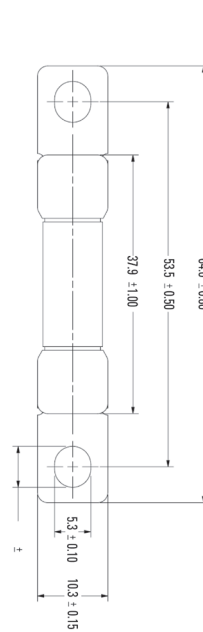

ZXPY Blade

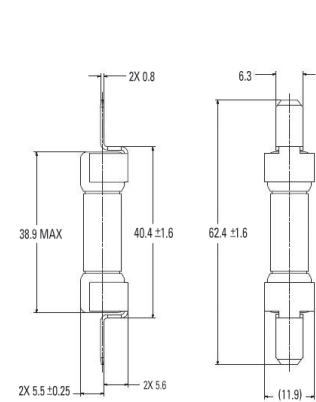

ZXBD Bolt Down (Axial)

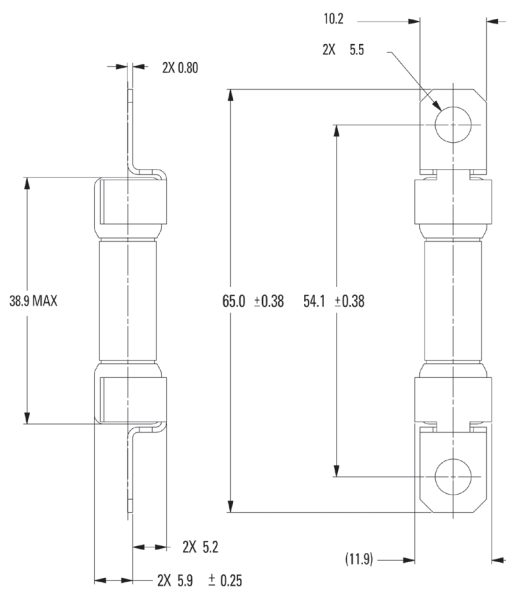

ZXPCB PCB Mount

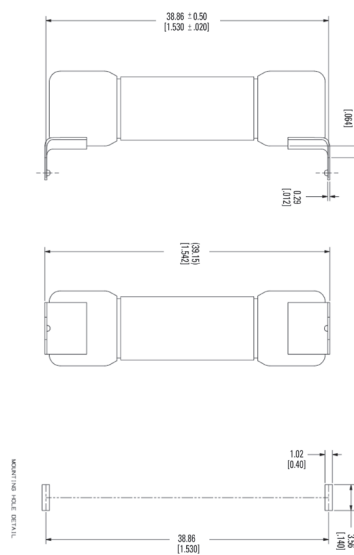

ZXPCBL PCB Mount (Long)

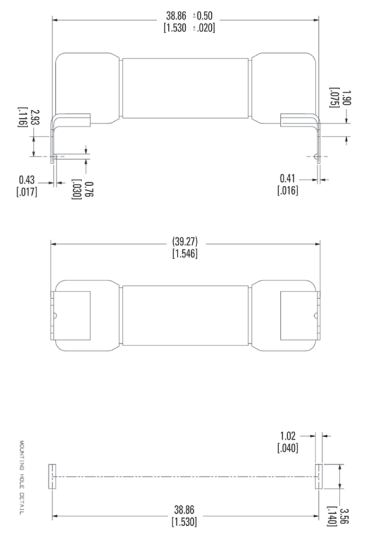

Littelfuse products are not designed for, and shall not be used for, any purpose (including, without limitation, automotive, military, aerospace, medical, life-saving, life-sustaining or nuclear facility applications, devices intended for surgical implant into the body, or any other application in which the failure or lack of desired operation of the product may result in personal injury, death, or property damage) other than those expressly set forth in applicable Littelfuse product documentation. Warranties granted by Littelfuse shall be deemed void for products used for any purpose not expressly set forth in applicable Littelfuse documentation. Littelfuse shall not be liable for any claims or damages arising out of products used in applications not expressly intended by Littelfuse as set forth in applicable Littelfuse documentation. The sale and use of Littelfuse products is subject to Littelfuse Terms and Conditions of Sale, unless otherwise agreed by Littelfuse.

Looking for pricing, stock, or lifecycle information?

Click below to explore more details on WIN SOURCE:

 [View 0HEV010.ZXBD on WIN SOURCE](#)

 [Littelfuse Inc. Information](#)

Optimize Your Supply Chain with WIN SOURCE Solutions

-  Global Sourcing Solution
-  Obsolete Management
-  Cost Control Management
-  Shortage Management
-  Alternative Solution
-  Excess Inventory Management