



THE DATASHEET OF
102TL2887-3



TL SERIES

005430

Issue 6

MICRO SWITCH Military-Grade Toggle Switches



DESCRIPTION

Honeywell MICRO SWITCH TL Series toggle switches are military qualified to MIL-DTL-3950, specifications for sealed toggle switches. Quality construction features include a bonded seal between the toggle lever and bushing, and between the cover and case.

The robust design of the TL Series toggle is well-suited for many military, aerospace and other demanding applications where reliability is essential. These applications include environments where the panels are subjected to mechanical shock, vibration, and temperature extremes as well as environments with dust, splashing or hose-directed water.

TL Series toggle switches offer a variety of circuitry and pole options to easily integrate into a number of applications. A long history in military and aerospace applications has shown the TL Series toggle switches provide reliable performance with long operating life under the toughest conditions.

FEATURES

- MIL-DTL-3950 qualified
- 1-, 2-, and 4-pole options
- 2- and 3-position, maintained and momentary
- Wide temperature range: -65 °C to 71 °C [-85 °F to 160 °F]
- UL recognized, CSA certified, and CE and UKCA approved
- Optional leverlocks
- Three termination options: screw, solder lugs, IWTS (Integrated Wire Termination System)
- Silver alloy or gold-plated contact options
- Engineered step-design case provides added space between terminals to prevent electrical shorting

POTENTIAL APPLICATIONS

- Military and commercial aircraft: fixed wing aircraft and helicopter flight decks
- Aviation ground support equipment: pumps, lights, and lift platforms
- Military land vehicles (track and wheeled vehicles): lights, pumps, arming equipment, and lifts/ramps, etc.
- Construction equipment: road milling, road pavers, trenchers, and stump cutters

VALUE TO CUSTOMERS

- MIL-DTL-3950 qualified switches available to meet military specifications
- Environmental sealing enables switches to withstand many demanding indoor and outdoor applications
- 1-, 2-, and 4-pole options for a variety of circuitry requirements
- 2- and 3-position, maintained and momentary toggle action to meet circuit and actuator requirements
- UL recognized, CSA certified, CE and UKCA approved for global use

DIFFERENTIATION

- Robust construction: Built from military-grade components to achieve MIL-DTL-3950 requirements
- Locking levers reduce unintended actuation

PORTFOLIO



Honeywell offers an extensive line of MICRO SWITCH toggle switches, including the following Series: MT, NT, TW, TS, AT and ET.

Honeywell

MICRO SWITCH MILITARY GRADE TOGGLE SWITCHES, TL SERIES

TABLE 1. SPECIFICATIONS

Characteristic	Parameter
Description	military-grade toggle switch
Sealing	qualified to MIL-DTL-3950
Operating temperature	-65 °C to 71 °C [-85 °F to 160 °F]
Actuators	standard, locking, special design, tab
Action	2- or 3- position; momentary and maintained
Mounting	Bushing 15/32 in (0.47 in) Ø
Circuitry	SPST, SPDT, DPST, DPDT, 4PST, 4PDT
Terminations	IWTS, solder, screw, quick-connect, leadwire
Contacts	Silver alloy or gold-plated
Amp rating	Up to 20 A, ac and dc capability
Approvals	UL, CSA, CE, UKCA
Measurement	26,7 mm H x 33,5 mm W x 22,6 mm D [1.05 in H x 1.32 in W x 0.89 in D]

TABLE 2. UL AND CSA ELECTRICAL RATINGS

Rating Code	Electrical Rating
L192	10 amps, 125, 250, 277 Vac; ¼ Hp, 125 Vac; ½ Hp, 250, 277 Vac; 3 amps, 125 Vac “L”
L191	15 amps, 125, 250, 277 Vac; ½ Hp, 125 Vac; 1 Hp, 250, 277 Vac; 5 amps, 125 Vac “L”

TABLE 3. ELECTRICAL RATINGS (IN AMPERES)

Electrical rating code	28 Vdc			115 Vdc	250 Vdc	115 Vac, 60 Hz & 400 Hz Max.			230 Vac
	Ind.	Res.	Lamp	Res.	Res.	Ind.	Res.	Lamp	Res.
1	15	20	5	0.75	0.5	10	15	3	6
2	10	15	4	0.75	0.5	7	15	2	6
3	15	20	7	0.75	0.5	15	15	4	6
4	10	18	5	0.75	0.5	8	11	2	6
5	12	20	5	0.75	0.5	15	15	4	6
6	10	18	4	0.75	0.5	8	11	2	6

MICRO SWITCH MILITARY GRADE TOGGLE SWITCHES, TL SERIES

TERMINAL CIRCUIT IDENTIFICATION

Terminal identifications are referred to in the order guides to indicate which circuits are made in each toggle position (i.e., 1-2 refers to circuit closure through terminals 1 and 2).

One Pole

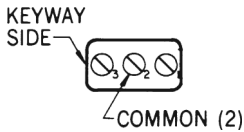

Two Pole

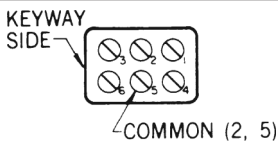

Four Pole

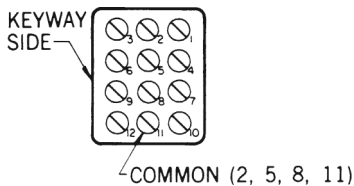

TERMINALS

In addition to the screw terminal listings in the order guides, IWTS (Integrated Wire Termination Systems) versions and solder current terminals are available.

IWTS provides a reliable, completely serviceable unit which meets MIL-DTL-3950 requirements. IWTS improves maintainability since wiring bundles need not be disturbed. Leads are quickly and easily assembled or removed with an insert-extract tool.

A unique three-rib (grommet style) elastomer seal protects the lead connections without potting. There are no exposed metal terminals.

Versions available that will accept No. 16 wire with M39029/1-102 contact pins or No. 20 wire with MS39029/1-101 contact pins. Connections are resistant to shock, vibration, and high pull-out force.

SPECIAL CIRCUITRIES

Catalog listings with -10, -50, and -70 suffix numbers, as shown in the order guides, have special “on-on-on” circuits, as illustrated below. TLs with -12 suffix are the same as -50 except the keyway position is maintained, and the center position circuits 2-3 and 4-5 are made. -72 is the same as -50 except that the opposite keyway position is momentary, and in the center position circuits 2-3 and 4-5 are made.

-10 CIRCUITRY

No of poles	Keyway Side Maint. Position	Center Maint. Position	Opposite Keyway Maint. Position
2			
4			

-50 CIRCUITRY

No of poles	Keyway Side Momentary Position	Center Maint. Position	Opposite Keyway Maint. Position
2			
4			

-70 CIRCUITRY

No of poles	Keyway Side Momentary Position	Center Maint. Position	Opposite Keyway Momentary Position
2			
4			

MICRO SWITCH MILITARY GRADE TOGGLE SWITCHES, TL SERIES

TL (SCREW TERMINAL) 2-POSITION ORDER GUIDE								
Circuits Made with Toggle At:				Standard Toggle			Pull-to-Unlock Toggle	
No. of poles	Keyway Position	Opposite Keyway	Elect. Rating Code	UL Rating Code	Catalog Listing	Military Number	Add Suffix to Standard Toggle Listing ^Δ	Military Number**
1	OFF	2-3	1	L191	1TL1-2	MS24523-22	D, F, G	MS24658-22
	OFF*	2-3	2	L192	1TL1-4	MS24523-29	F	MS24658-29
	1-2*	OFF	2	L192	1TL1-6	MS24523-30	F	MS24658-30
	1-2	2-3	1	L191	1TL1-3	MS24523-23	D, F, G	MS24658-23
	1-2*	2-3	2	L192	1TL1-8	MS24523-26	F	MS24658-26
2	OFF	2-3, 5-6	3	L191	2TL1-2	MS24524-22	D, F, G	MS24659-22
	OFF*	2-3, 5-6	4	L192	2TL1-4	MS24524-29	F	MS24659-29
	1-2, 4-5*	OFF	4	L192	2TL1-6	MS24524-30	F	MS24659-30
	1-2, 4-5	2-3, 5-6	3	L191	2TL1-3	MS24524-23	D, F, G	MS24659-23
	1-2, 4-5*	2-3, 5-6	4	L192	2TL1-8	MS24524-26	F	MS24659-26
4	OFF	2-3, 5-6, 8-9, 11-12	5	L191	4TL1-2	MS24525-22	D, F, G	MS24660-22
	OFF*	2-3, 5-6, 8-9, 11-12	6	L192	4TL1-4	MS24525-29	F	MS24660-29
	1-2, 4-5, 7-8, 10-11*	OFF	6	L192	4TL1-6	MS24525-30	F	MS24660-30
	1-2, 4-5, 7-8, 10-11	2-3, 5-6, 8-9, 11-12	5	L191	4TL1-3	MS24525-23	D, F, G	MS24660-23
	1-2, 4-5*, 7-8, 10-11	2-3, 5-6, 8-9, 11-12	6	L192	4TL1-8	MS24525-26	F	MS24660-26

* These positions are momentary. All others are maintained.

** Also add the appropriate suffix to the military number.

^Δ See page 12 for locking configurations.

PULL-TO-UNLOCK OPTION

When ordering pull-to-unlock toggle listings (see page 12 for configurations), add the suffix letter shown in the chart on page XXX to the standard toggle listing or the MS part number. For example, to order a 1TL1-1 pull-to-unlock toggle switch with the lever locked in the center position, add the letter **E** (i.e., 1TL1-1E, MS24658-21E)



SOLDER TURRET TERMINAL VERSION

11TL, 12TL, and 14TL type switches with solder turrent terminals are qualified to MIL-DTL-3950. They have the same circuitry and electrical ratings as their 1TL, 2TL, and 4TL counterparts. For example, an 11TL1-2 is the same as a 1TL1-2, except it has solder turret terminals instead of screw terminals.

Circuitry	Type	Standard Lever	Lever Lock
One pole	11TL	MS27734	MS27737
Two pole	12TL	MS27735	MS27738
Four pole	14TL	MS27736	MS27739

MICRO SWITCH MILITARY GRADE TOGGLE SWITCHES, TL SERIES

TL (SCREW TERMINAL) 3-POSITION ORDER GUIDE

Circuits Made with Toggle At:						Standard Toggle		Pull-to-Unlock Toggle	
No. of poles	Keyway Position	Center Position	Opposite Keyway	Elect. Rating Code	UL/CSA Rating Code	Catalog Listing	Military Number	Add Suffix to Standard Toggle Listing ^Δ	Military Number ^{***}
1	1-2	OFF	2-3	1	L191	1TL1-1	MS24523-21	ALL TYPES	MS24658-21
	1-2*	OFF	2-3	2	L192	1TL1-5	MS24523-31	E, F, K, L, M, N	MS24658-31
	1-2*	OFF	2-3*	2	L192	1TL1-7	MS24523-27	E, L, N	MS24658-27
	NONE**	OFF	2-3	1	L191	1TL1-21	MS24523-24	E, F, K, M	MS24658-24
	NONE**	1-2	2-3	1	L192	1TL1-31	MS24523-33	E, F, K, M	MS24658-33
	NONE**	1-2	2-3*	2	L192	1TL1-51	MS24523-32	E	MS24658-32
	1-2*	OFF	NONE**	2	L192	1TL1-61	MS24523-28	E	MS24658-28
2	1-2, 4-5	OFF	2-3, 5-6	3	L191	2TL1-1	MS24524-21	ALL TYPES	MS24659-21
	1-2, 4-5*	OFF	2-3, 5-6	4	L192	2TL1-5	MS24524-31	E, F, K, L, M, N	MS24659-31
	1-2, 4-5*	OFF	2-3, 5-6*	4	L192	2TL1-7	MS24524-27	E, L, N	MS24659-27
	NONE**	OFF	2-3, 5-6	3	L191	2TL1-21	MS24524-24	E, F, K, M	MS24659-24
	NONE**	1-2, 4-5	2-3, 5-6	3	L191	2TL1-31	MS24524-33	E, F, K, M	MS24659-33
	NONE**	1-2, 4-5	2-3, 5-6*	4	L192	2TL1-51	MS24524-32	E	MS24659-32
	1-2, 4-5*	OFF	NONE**	4	L192	2TL1-61	MS24524-28	E	MS24659-28
	1-2, 4-5	1-2, 5-6	2-3, 5-6	3	L191	2TL1-10	MS27407-4	ALL TYPES	MS27408-4
	1-2, 4-5*	1-2, 5-6	2-3, 5-6	4	L192	2TL1-50	MS27407-5	E, F, K, L, M, N	MS27408-5
	1-2, 4-5*	1-2, 5-6	2-3, 5-6*	4	L192	2TL1-70	MS27407-6	E, L, N	MS27408-6
4	1-2, 4-5, 7-8, 10-11	OFF	2-3, 5-6, 8-9, 11-12	5	L191	4TL1-1	MS24525-21	ALL TYPES	MS24660-21
	1-2, 4-5, 7-8, 10-11*	OFF	2-3, 5-6, 8-9, 11-12	6	L192	4TL1-5	MS24525-31	E, F, K, L, M, N	MS24660-31
	1-2, 4-5, 7-8, 10-11*	OFF	2-3, 5-6, 8-9, 11-12*	6	L192	4TL1-7	MS24525-27	E, L, N	MS24660-27
	NONE**	OFF	2-3, 5-6, 8-9, 11-12	5	L191	4TL1-21	MS24525-24	E, F, K, M	MS24660-24
	NONE**	1-2, 4-5, 7-8, 10-11	2-3, 5-6, 8-9, 11-12	5	L191	4TL1-31	MS24525-33	E, F, K, M	MS24660-33
	NONE**	1-2, 4-5, 7-8, 10-11	2-3, 5-6, 8-9, 11-12*	6	L192	4TL1-51	MS24525-32	E	MS24660-32
	1-2, 4-5, 7-8, 10-11*	OFF	NONE**	6	L192	4TL1-61	MS24525-38	E	MS24660-28
	1-2, 4-5, 7-8, 10-11	2-3, 4-5	2-3, 5-6, 8-9, 11-12	5	L191	4TL1-10	–	ALL TYPES	–
	1-2, 4-5, 7-8, 10-11*	2-3, 4-5, 7-8, 11-12	2-3, 5-6, 8-9, 11-12	6	L192	4TL1-50	MS27406-2	E, F, K, L, M, N	MS27409-2
	1-2, 4-5, 7-8, 10-11*	2-3, 4-5	2-3, 5-6, 8-9, 11-12*	6	L192	4TL1-70	–	E, L, N	–
	1-2, 4-5, 7-8, 10-11	2-3, 4-5, 7-8, 11-12	2-3, 5-6, 8-9, 11-12	5	L191	4TL1-12	MS27406-1	ALL TYPES	MS27409-1
	1-2, 4-5, 7-8, 10-11*	2-3, 4-5, 7-8, 11-12	2-3, 5-6, 8-9, 11-12*	6	L192	4TL1-72	MS27406-3	E, L, N	MS27409-3

* These positions are momentary. All others are maintained.

** Toggle lever is blocked from these products. Toggle becomes 2-position, with center being one extreme position.

*** Also add appropriate suffix letter to military number

^Δ See page 12 for locking configurations.

MICRO SWITCH MILITARY GRADE TOGGLE SWITCHES, TL SERIES

TL (IWTS TERMINATION) 2-POSITION ORDER GUIDE

Circuits Made with Toggle At:					No. 16 Termination		No. 20 Termination	
No. of poles	Keyway Position	Opposite Keyway	Elect. Rating Code	UL Rating Code	Catalog Listing	Military Number	Catalog Listing	Military Number
1	OFF	2-3	1	L191	101TL1-2	MS27722-22	101TL2-2	MS27784-22
	OFF*	2-3	2	L192	101TL1-4	MS27722-29	101TL2-4	MS27784-29
	1-2*	OFF	2	L192	101TL1-6	MS27722-30	101TL2-6	MS27784-30
	1-2	2-3	1	L191	101TL1-3	MS27722-23	101TL2-3	MS27784-23
	1-2*	2-3	2	L192	101TL1-8	MS27722-26	101TL2-8	MS27784-26
2	OFF	2-3, 5-6	3	L191	102TL1-2	MS27723-22	102TL2-2	MS27785-22
	OFF*	2-3, 5-6	4	L192	102TL1-4	MS27723-29	102TL2-4	MS27785-29
	1-2, 4-5*	OFF	4	L192	102TL1-6	MS27723-30	102TL2-6	MS27785-30
	1-2, 4-5	2-3, 5-6	3	L191	102TL1-3	MS27723-23	102TL2-3	MS27785-23
	1-2, 4-5*	2-3, 5-6	4	L192	102TL1-8	MS27723-26	102TL2-8	MS27785-26
4	OFF	2-3, 5-6, 8-9, 11-12	5	L191	104TL1-2	MS27724-22	104TL2-2	MS27786-22
	OFF*	2-3, 5-6, 8-9, 11-12	6	L192	104TL1-4	MS27724-29	104TL2-4	MS27786-29
	1-2, 4-5, 7-8, 10-11*	OFF	6	L192	104TL1-6	MS27724-30	104TL2-6	MS27786-30
	1-2, 4-5, 7-8, 10-11	2-3, 5-6, 8-9, 11-12	5	L191	104TL1-3	MS27724-23	104TL2-3	MS27786-23
	1-2, 4-5, 7-8, 10-11*	2-3, 5-6, 8-9, 11-12	6	L192	104TL1-8	MS27724-26	104TL2-8	MS27786-26

TL (IWTS TERMINATION) 3-POSITION ORDER GUIDE

Circuits Made with Toggle At:						No. 16 Termination		No. 20 Termination	
No. of poles	Keyway Position	Center Position	Opposite Keyway	Elect. Rating Code	UL/CSA Rating Code	Catalog Listing	Military Number	Add Suffix to Standard Toggle Listing ^Δ	Military Number***
1	1-2	OFF	2-3	1	L191	101TL1-1	MS27722-21	101TL2-1	MS27784-21
	1-2*	OFF	2-3	2	L192	101TL1-5	MS27722-31	101TL2-5	MS27784-31
	1-2*	OFF	2-3*	2	L192	101TL1-7	MS27722-27	101TL2-7	MS27784-27
2	1-2, 4-5	OFF	2-3, 5-6	3	L191	102TL1-1	MS27723-21	102TL2-1	MS27785-21
	1-2, 4-5*	OFF	2-3, 5-6	4	L192	102TL1-5	MS27723-31	102TL2-5	MS27785-31
	1-2, 4-5*	OFF	2-3, 5-6*	4	L192	102TL1-7	MS27723-6	102TL2-7	MS27785-27
4	1-2, 4-5, 7-8, 10-11	OFF	2-3, 5-6, 8-9, 11-12	5	L191	104TL1-1	MS27724-21	104TL2-1	MS27786-21
	1-2, 4-5, 7-8, 10-11*	OFF	2-3, 5-6, 8-9, 11-12	6	L192	104TL1-5	MS27724-31	104TL2-5	MS27786-31
	1-2, 4-5, 7-8, 10-11*	OFF	2-3, 5-6, 8-9, 11-12*	6	L192	104TL1-7	MS27724-27	104TL2-7	MS27786-27

* These positions are momentary. All others are maintained.

NOTE: For TL switches featuring IWTS termination and a "pull-to-unlock" lever option, contact a Honeywell Sensing and Control representative at 1-800-537-6945.

MICRO SWITCH MILITARY GRADE TOGGLE SWITCHES, TL SERIES

TL SERIES 1-POLE STANDARD ACTUATOR OPTIONS, TERMINALS, & DIMENSIONS

Note: Three-position switches shown

1TL1: Single pole, standard lever, screw terminals

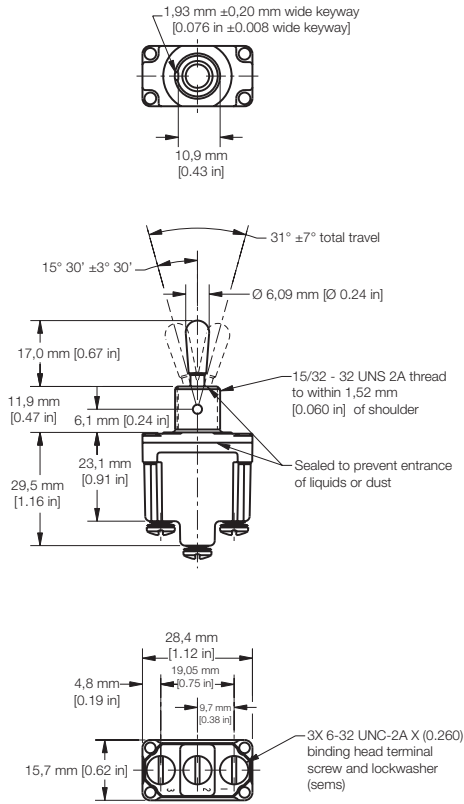

11TL1: Single pole, standard lever, solder terminals

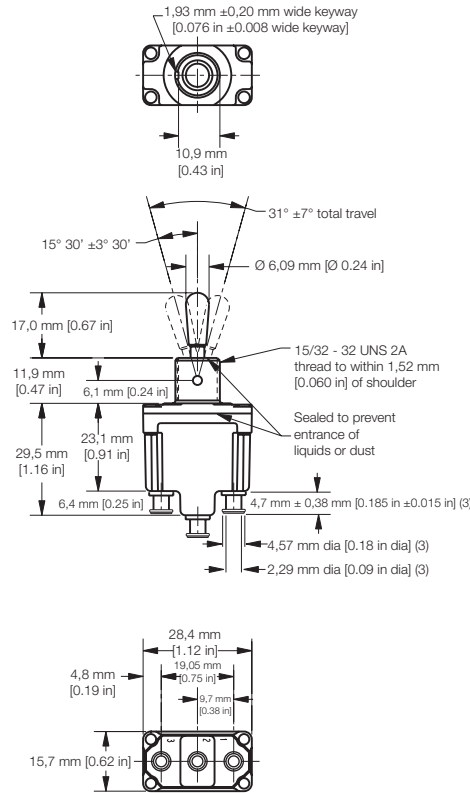

101TL1: Single pole, standard lever, IWTS terminals

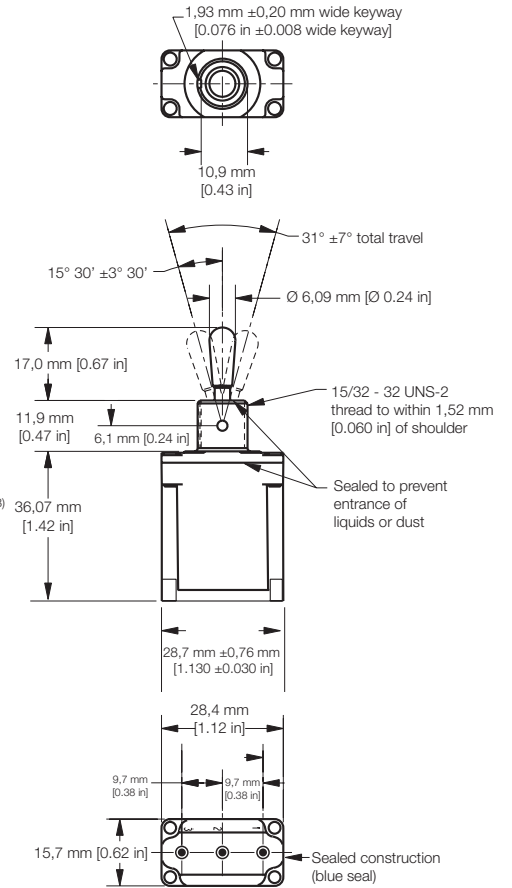

Locking lever dimensions for single-pole TL toggles

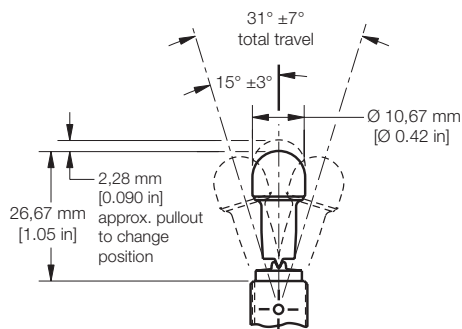

MICRO SWITCH MILITARY GRADE TOGGLE SWITCHES, TL SERIES

TL SERIES 2-POLE STANDARD ACTUATOR OPTIONS, TERMINALS, & DIMENSIONS

Note: Three-position switches shown

2TL1: Single pole, standard lever, screw terminals

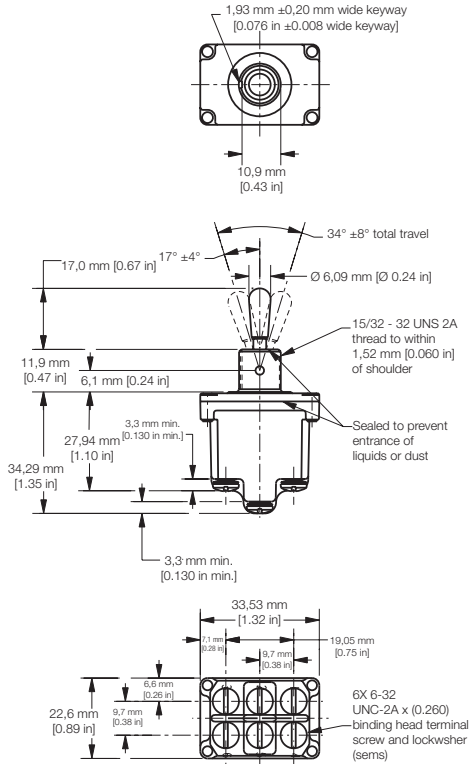

12TL1: Single pole, standard lever, solder terminals

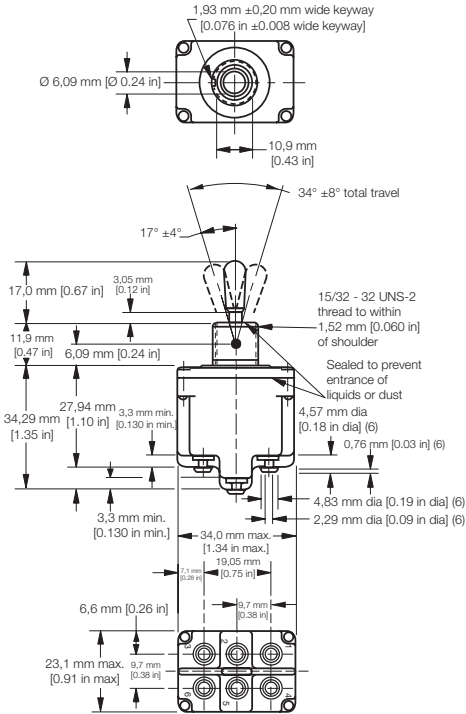

102TL1: Single pole, standard lever, IWTS terminals

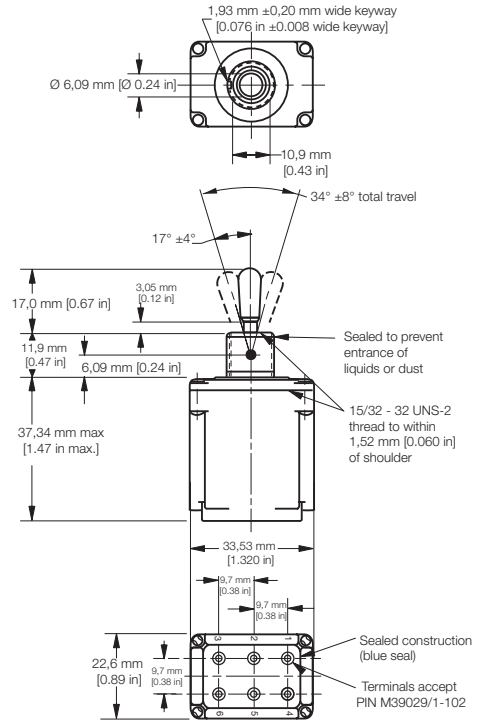

Locking lever dimensions for double-pole TL toggles

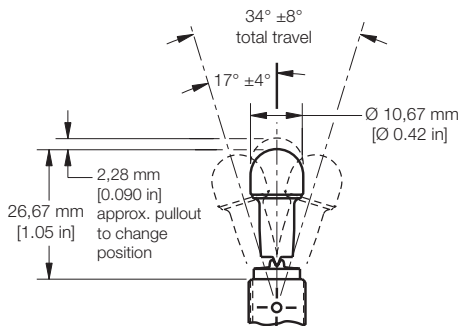

MICRO SWITCH MILITARY GRADE TOGGLE SWITCHES, TL SERIES

TL SERIES 4-POLE STANDARD ACTUATOR OPTIONS, TERMINALS, & DIMENSIONS

Note: Three-position switches shown

4TL1: Four-pole, standard lever, screw terminals

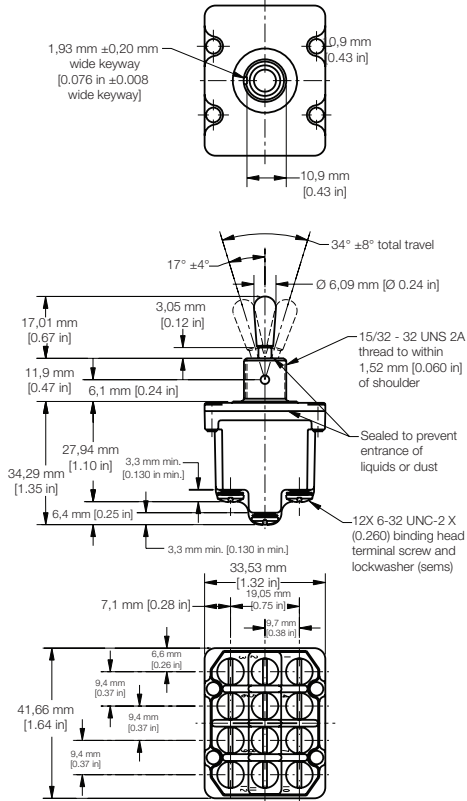

14TL1: Four-pole, standard lever, solder terminals

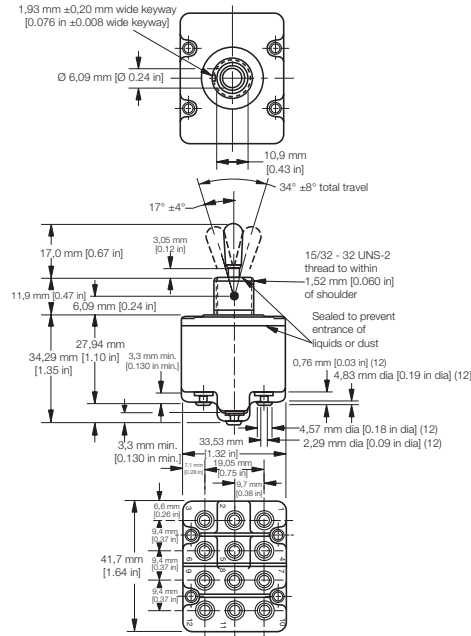

104TL1: Four pole, standard lever, IWTS terminals

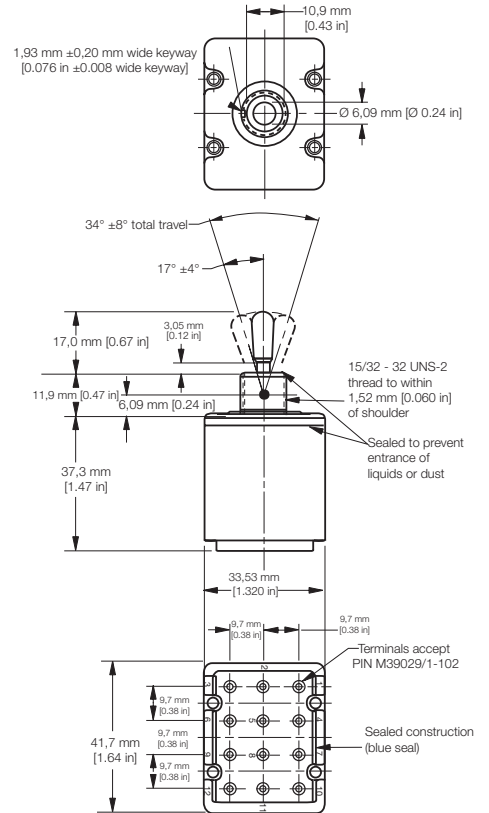



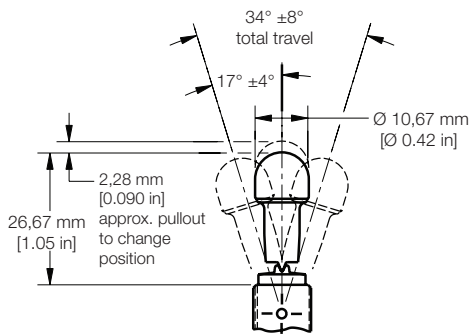









Locking lever dimensions for four-pole TL toggles



MICRO SWITCH MILITARY GRADE TOGGLE SWITCHES, TL SERIES

MICRO SWITCH TL SERIES LOCKING CONFIGURATIONS

<p style="text-align: center;">A</p>  <p style="text-align: center;">Locked In Three Positions</p>	<p style="text-align: center;">B</p>  <p style="text-align: center;">Locked In Center and Extreme Position (Keyway Side)</p>	<p style="text-align: center;">D</p>  <p style="text-align: center;">Locked Out Of Center Position</p>	<p style="text-align: center;">E</p>  <p style="text-align: center;">Locked In Center Position</p>	<p style="text-align: center;">F</p>  <p style="text-align: center;">Locked In Extreme Position (Opposite Keyway)</p>	<p style="text-align: center;">G</p>  <p style="text-align: center;">Locked In Extreme Position (Keyway Side)</p>	<p style="text-align: center;">H</p>  <p style="text-align: center;">Locked Out Of Center And Extreme Position (Keyway Side)</p>
<p style="text-align: center;">J</p>  <p style="text-align: center;">Locked Out Of Center And Extreme Position (Opposite Keyway)</p>	<p style="text-align: center;">K</p>  <p style="text-align: center;">Locked In Center And Extreme Position (Opposite Keyway)</p>	<p style="text-align: center;">L</p>  <p style="text-align: center;">Locked Out Of Extreme Position (Keyway Side)</p>	<p style="text-align: center;">M</p>  <p style="text-align: center;">Locked Out Of And Into Extreme Position (Opposite Keyway)</p>	<p style="text-align: center;">N</p>  <p style="text-align: center;">Locked Out Of Extreme Position (Opposite Keyway)</p>	<p style="text-align: center;">P</p>  <p style="text-align: center;">Locked Out Of And Into Extreme Position (Keyway Side)</p>	

ADDITIONAL MATERIALS

The following associated literature is available on the Honeywell web site at sps.honeywell.com/ast:

- Product installation instructions
- Product range guide
- Product application-specific information
 - Flight deck toggle switches
 - Sensors and switches in front loaders
 - Sensors and switches in mobile cranes
 - Sensors and switches in oil rig applications

WARRANTY/REMEDY

Honeywell warrants goods of its manufacture as being free of defective materials and faulty workmanship during the applicable warranty period. Honeywell's standard product warranty applies unless agreed to otherwise by Honeywell in writing; please refer to your order acknowledgment or consult your local sales office for specific warranty details. If warranted goods are returned to Honeywell during the period of coverage, Honeywell will repair or replace, at its option, without charge those items that Honeywell, in its sole discretion, finds defective. The foregoing is buyer's sole remedy and is in lieu of all other warranties, expressed or implied, including those of merchantability and fitness for a particular purpose. In no event shall Honeywell be liable for consequential, special, or indirect damages.

While Honeywell may provide application assistance personally, through our literature and the Honeywell web site, it is buyer's sole responsibility to determine the suitability of the product in the application.

Specifications may change without notice. The information we supply is believed to be accurate and reliable as of this writing. However, Honeywell assumes no responsibility for its use.

FOR MORE INFORMATION

Honeywell Advanced Sensing Technologies services its customers through a worldwide network of sales offices and distributors. For application assistance, current specifications, pricing or the nearest Authorized Distributor, visit [our website](#) or call:

USA/Canada	+1 302 613 4491
Latin America	+1 305 805 8188
Europe	+44 1344 238258
Japan	+81 (0) 3-6730-7152
Singapore	+65 6355 2828
Greater China	+86 4006396841

Honeywell Advanced Sensing Technologies

830 East Arapaho Road
Richardson, TX 75081
sps.honeywell.com/ast

WARNING PERSONAL INJURY

DO NOT USE these products as safety or emergency stop devices or in any other application where failure of the product could result in personal injury.

Failure to comply with these instructions could result in death or serious injury.

WARNING MISUSE OF DOCUMENTATION

- The information presented in this product sheet is for reference only. Do not use this document as a product installation guide.
- Complete installation, operation, and maintenance information is provided in the instructions supplied with each product.

Failure to comply with these instructions could result in death or serious injury.

Looking for pricing, stock, or lifecycle information?

Click below to explore more details on WIN SOURCE:

 [View 102TL2887-3 on WIN SOURCE](#)

 [Honeywell Information](#)

Optimize Your Supply Chain with WIN SOURCE Solutions

-  Global Sourcing Solution
-  Obsolete Management
-  Cost Control Management
-  Shortage Management
-  Alternative Solution
-  Excess Inventory Management