



# BMS4007

## N-Channel Power MOSFET 75V, 60A, 7.8mΩ, TO-220ML(LS)

ON Semiconductor®

<http://onsemi.com>

### Features

- ON-resistance  $R_{DS(on)}=6m\Omega$  (typ.)
- Input capacitance  $C_{iss}=9700pF$  (typ.)
- 10V drive

### Specifications

Absolute Maximum Ratings at  $T_a=25^\circ C$

Parameter	Symbol	Conditions	Ratings	Unit
Drain-to-Source Voltage	$V_{DS}$		75	V
Gate-to-Source Voltage	$V_{GS}$		$\pm 20$	V
Drain Current (DC)	$I_D$		60	A
Drain Current (Pulse)	$I_{DP}$	$PW \leq 10\mu s$ , duty cycle $\leq 1\%$	240	A
Allowable Power Dissipation	PD		2.0	W
		$T_c=25^\circ C$	30	W
Channel Temperature	$T_{ch}$		150	$^\circ C$
Storage Temperature	$T_{stg}$		-55 to +150	$^\circ C$
Avalanche Energy (Single Pulse) *1	EAS		299	mJ
Avalanche Current *2	$I_{AV}$		48	A

Note : \*1  $V_{DD}=48V$ ,  $L=100\mu H$ ,  $I_{AV}=48A$  (Fig.1)

\*2  $L \leq 100\mu H$ , Single pulse

Stresses exceeding Maximum Ratings may damage the device. Maximum Ratings are stress ratings only. Functional operation above the Recommended Operating Conditions is not implied. Extended exposure to stresses above the Recommended Operating Conditions may affect device reliability.

### Package Dimensions

unit : mm (typ)

7525-002

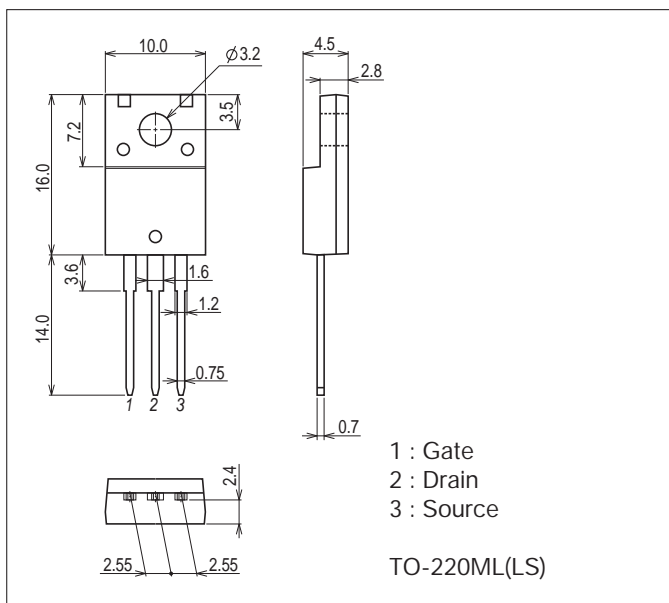

### Product & Package Information

- Package : TO-220ML(LS)
- JEITA, JEDEC : SC-67, SOT-186A
- Minimum Packing Quantity : 100 pcs./bag or 50pcs./magazine

### Marking

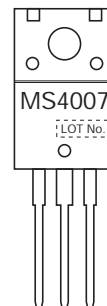

### Electrical Connection

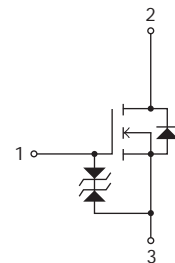

Electrical Characteristics at Ta=25°C

Parameter	Symbol	Conditions	Ratings			Unit
			min	typ	max	
Drain-to-Source Breakdown Voltage	$V_{(BR)DSS}$	$I_D=1mA, V_{GS}=0V$	75			V
Zero-Gate Voltage Drain Current	$I_{DSS}$	$V_{DS}=75V, V_{GS}=0V$			10	$\mu A$
Gate-to-Source Leakage Current	$I_{GSS}$	$V_{GS}=\pm 16V, V_{DS}=0V$			$\pm 10$	$\mu A$
Cutoff Voltage	$V_{GS(off)}$	$V_{DS}=10V, I_D=1mA$	2		4	V
Forward Transfer Admittance	$ y_{fs} $	$V_{DS}=10V, I_D=30A$		110		S
Static Drain-to-Source On-State Resistance	$R_{DS(on)}$	$I_D=30A, V_{GS}=10V$		6	7.8	$m\Omega$
Input Capacitance	$C_{iss}$	$V_{DS}=20V, f=1MHz$		9700		pF
Output Capacitance	$C_{oss}$			540		pF
Reverse Transfer Capacitance	$C_{rss}$			360		pF
Turn-ON Delay Time	$t_{d(on)}$		See Fig.2		100	
Rise Time	$t_r$			180		ns
Turn-OFF Delay Time	$t_{d(off)}$			460		ns
Fall Time	$t_f$			160		ns
Total Gate Charge	$Q_g$	$V_{DS}=48V, V_{GS}=10V, I_D=60A$			160	
Gate-to-Source Charge	$Q_{gs}$			40		nC
Gate-to-Drain "Miller" Charge	$Q_{gd}$			40		nC
Diode Forward Voltage	$V_{SD}$	$I_S=60A, V_{GS}=0V$		0.9	1.2	V
Reverse Recovery Time	$t_{rr}$	See Fig.3		70		ns
Reverse Recovery Charge	$Q_{rr}$	$I_S=60A, V_{GS}=0V, di/dt=100A/\mu s$		183		nC

Fig.1 Avalanche Resistance Test Circuit

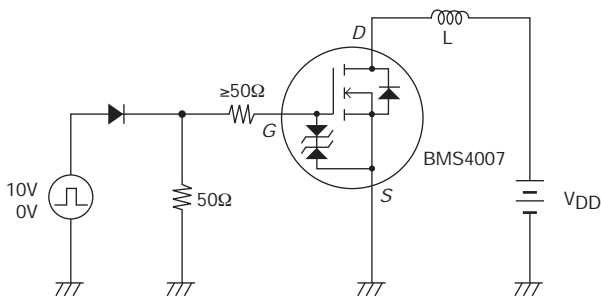

Fig.2 Switching Time Test Circuit

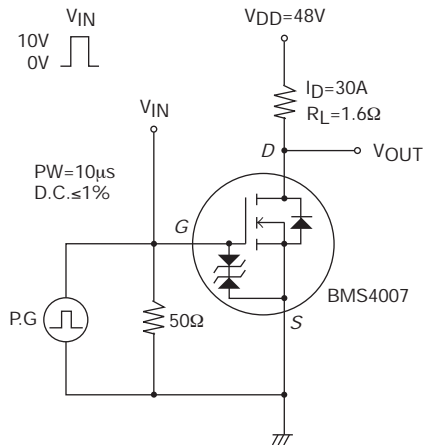
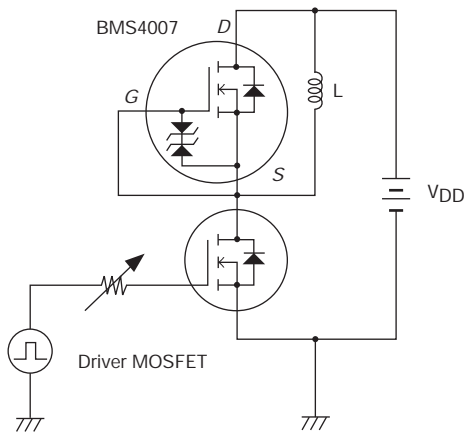
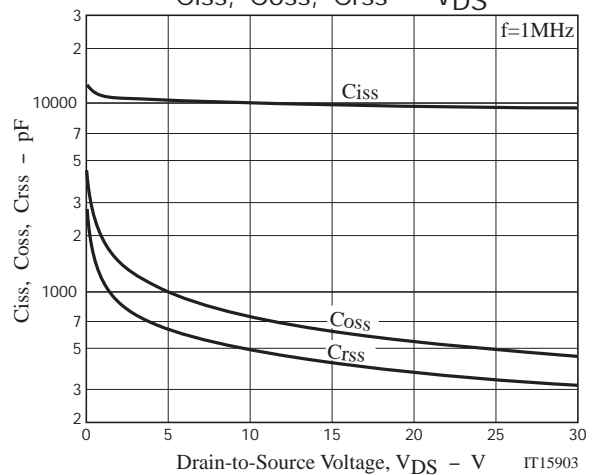
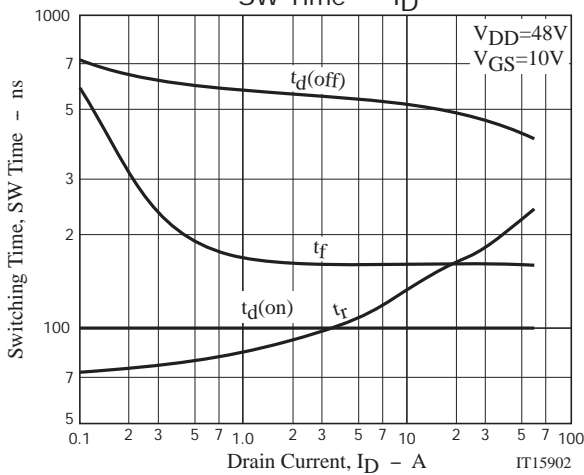
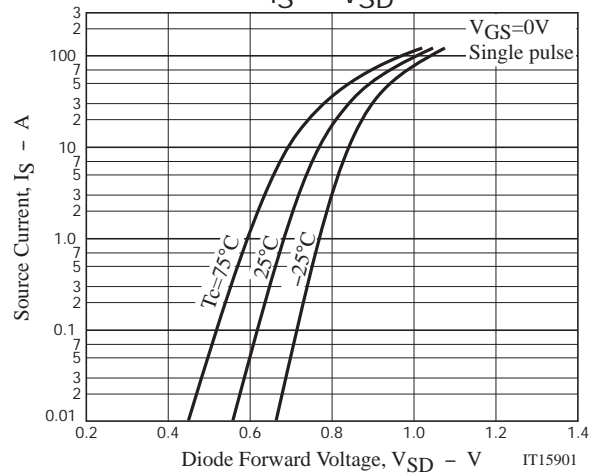
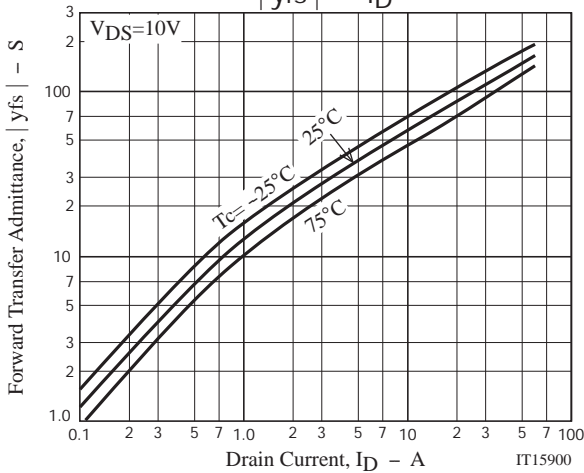
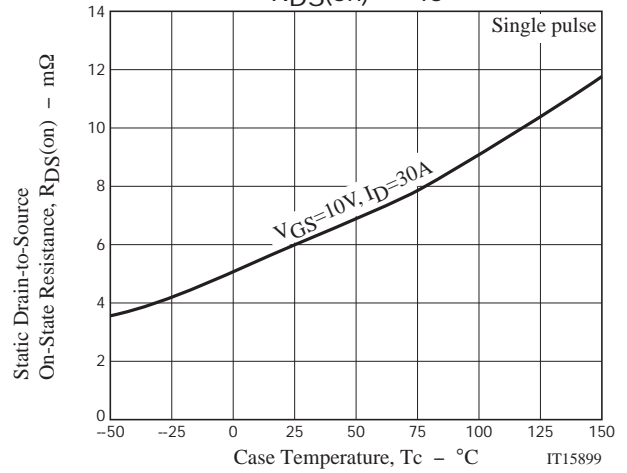
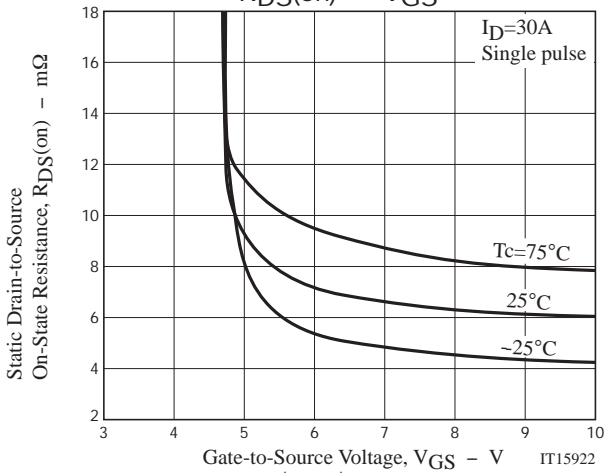
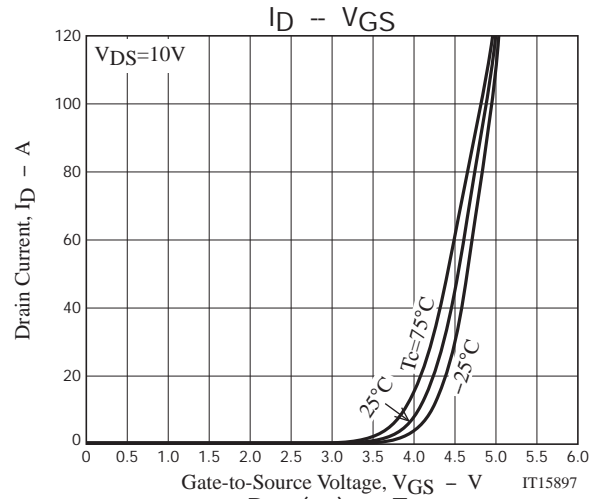
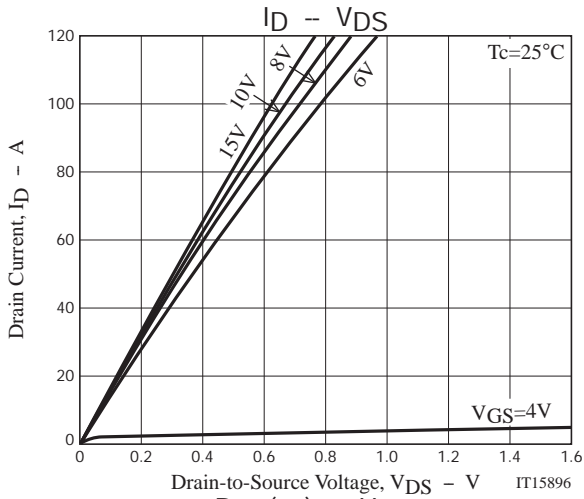
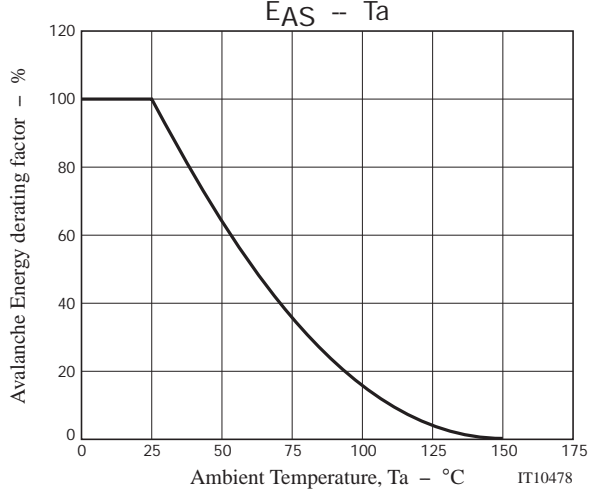
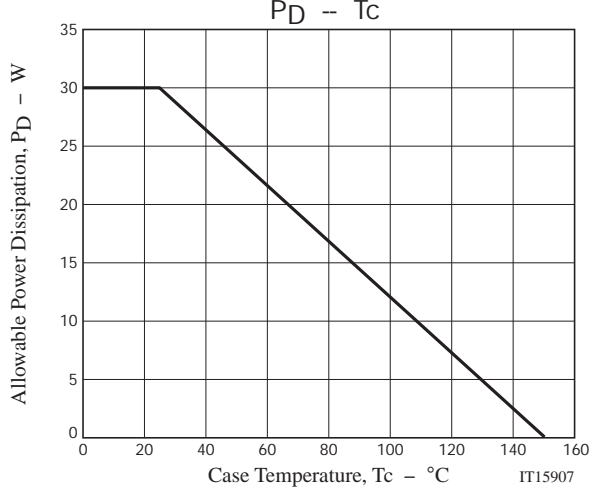
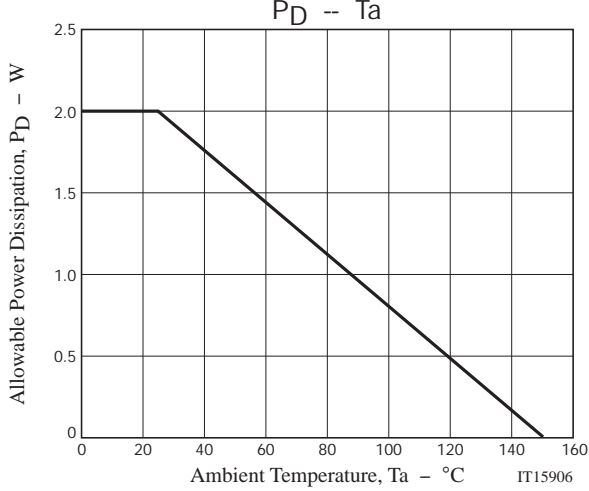
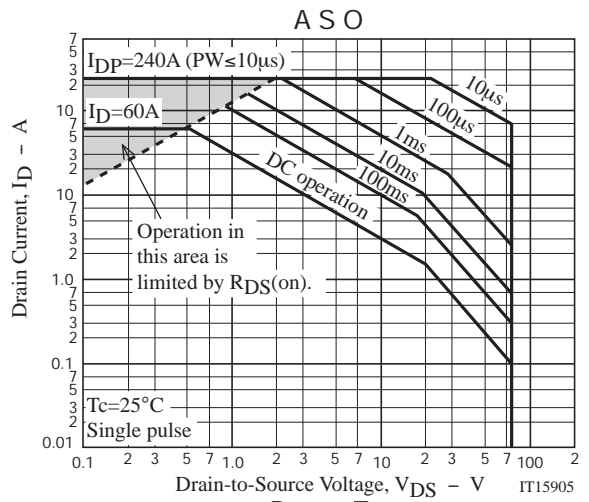
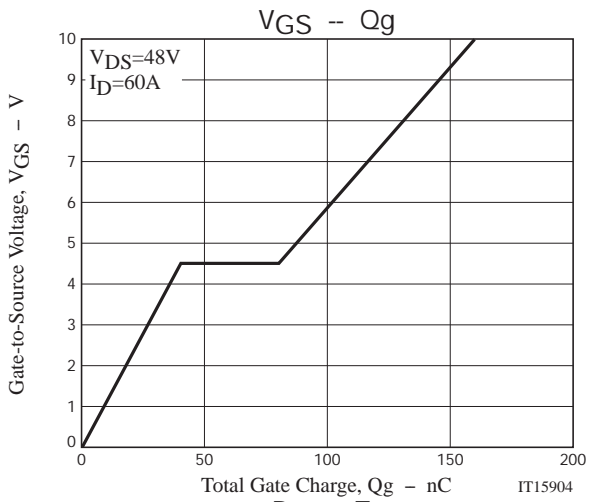

Fig.3 Reverse Recovery Time Test Circuit









Note on usage : Since the BMS4007 is a MOSFET product, please avoid using this device in the vicinity of highly charged objects.

ON Semiconductor and the ON logo are registered trademarks of Semiconductor Components Industries, LLC (SCILLC). SCILLC owns the rights to a number of patents, trademarks, copyrights, trade secrets, and other intellectual property. A listing of SCILLC's product/patent coverage may be accessed at [www.onsemi.com/site/pdf/Patent-Marking.pdf](http://www.onsemi.com/site/pdf/Patent-Marking.pdf). SCILLC reserves the right to make changes without further notice to any products herein. SCILLC makes no warranty, representation or guarantee regarding the suitability of its products for any particular purpose, nor does SCILLC assume any liability arising out of the application or use of any product or circuit, and specifically disclaims any and all liability, including without limitation special, consequential or incidental damages. "Typical" parameters which may be provided in SCILLC data sheets and/or specifications can and do vary in different applications and actual performance may vary over time. All operating parameters, including "Typicals" must be validated for each customer application by customer's technical experts. SCILLC does not convey any license under its patent rights nor the rights of others. SCILLC products are not designed, intended, or authorized for use as components in systems intended for surgical implant into the body, or other applications intended to support or sustain life, or for any other application in which the failure of the SCILLC product could create a situation where personal injury or death may occur. Should Buyer purchase or use SCILLC products for any such unintended or unauthorized application, Buyer shall indemnify and hold SCILLC and its officers, employees, subsidiaries, affiliates, and distributors harmless against all claims, costs, damages, and expenses, and reasonable attorney fees arising out of, directly or indirectly, any claim of personal injury or death associated with such unintended or unauthorized use, even if such claim alleges that SCILLC was negligent regarding the design or manufacture of the part. SCILLC is an Equal Opportunity/Affirmative Action Employer. This literature is subject to all applicable copyright laws and is not for resale in any manner.

## Looking for pricing, stock, or lifecycle information?

Click below to explore more details on WIN SOURCE:

-  [View BMS4007-1E on WIN SOURCE](#)
-  [ON Semiconductor](#) Information

## Optimize Your Supply Chain with WIN SOURCE Solutions

-  Global Sourcing Solution
-  Obsolete Management
-  Cost Control Management
-  Shortage Management
-  Alternative Solution
-  Excess Inventory Management