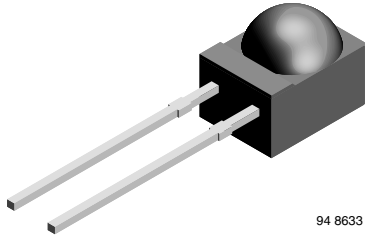




THE DATASHEET OF BPV22F



Silicon PIN Photodiode



FEATURES

- Package type: leaded
- Package form: side view
- Dimensions (in mm): 4.5 x 5 x 6
- Radiant sensitive area (in mm²): 7.5
- High radiant sensitivity
- Daylight blocking filter matched with 940 nm emitters
- Fast response times
- Angle of half sensitivity: $\phi = \pm 60^\circ$
- Compliant to RoHS Directive 2002/95/EC and in accordance to WEEE 2002/96/EC



Note

** Please see document "Vishay Material Category Policy":
www.vishay.com/doc?99902

APPLICATIONS

- High speed detector for infrared radiation
- Infrared remote control and free air data transmission systems, e.g. in combination with TSALxxxx series IR emitters

DESCRIPTION

BPV22F is a PIN photodiode with high speed and high radiant sensitivity in a black, plastic package with side view lens and daylight blocking filter. Filter bandwidth is matched with 900 nm to 950 nm IR emitters. The lens achieves 80 % of sensitivity improvement in comparison with flat package.

PRODUCT SUMMARY			
COMPONENT	I_{ra} (μA)	ϕ (deg)	$\lambda_{0.5}$ (nm)
BPV22F	80	± 60	870 to 1050

Note

- Test condition see table "Basic Characteristics"

ORDERING INFORMATION			
ORDERING CODE	PACKAGING	REMARKS	PACKAGE FORM
BPV22F	Bulk	MOQ: 4000 pcs, 4000 pcs/bulk	Side view

Note

- MOQ: minimum order quantity

ABSOLUTE MAXIMUM RATINGS ($T_{amb} = 25^\circ C$, unless otherwise specified)				
PARAMETER	TEST CONDITION	SYMBOL	VALUE	UNIT
Reverse voltage		V_R	60	V
Power dissipation	$T_{amb} \leq 25^\circ C$	P_V	215	mW
Junction temperature		T_j	100	$^\circ C$
Operating temperature range		T_{amb}	- 40 to + 100	$^\circ C$
Storage temperature range		T_{stg}	- 40 to + 100	$^\circ C$
Soldering temperature	$t \leq 5$ s	T_{sd}	260	$^\circ C$
Thermal resistance junction/ambient	Connected with Cu wire, 0.14 mm ²	R_{thJA}	350	K/W

BASIC CHARACTERISTICS ($T_{amb} = 25\text{ }^{\circ}\text{C}$, unless otherwise specified)						
PARAMETER	TEST CONDITION	SYMBOL	MIN.	TYP.	MAX.	UNIT
Forward voltage	$I_F = 50\text{ mA}$	V_F		1	1.3	V
Breakdown voltage	$I_R = 100\text{ }\mu\text{A}$, $E = 0$	$V_{(BR)}$	60			V
Reverse dark current	$V_R = 10\text{ V}$, $E = 0$	I_{ro}		2	30	nA
Diode capacitance	$V_R = 0\text{ V}$, $f = 1\text{ MHz}$, $E = 0$	C_D		70		pF
Serial resistance	$V_R = 12\text{ V}$, $f = 1\text{ MHz}$	R_S		400		Ω
Open circuit voltage	$E_e = 1\text{ mW/cm}^2$, $\lambda = 950\text{ nm}$	V_o		370		mV
Temperature coefficient of V_o	$E_e = 1\text{ mW/cm}^2$, $\lambda = 950\text{ nm}$	TK_{V_o}		- 2.6		mV/K
Short circuit current	$E_e = 1\text{ mW/cm}^2$, $\lambda = 950\text{ nm}$	I_k		75		μA
Reverse light current	$E_e = 1\text{ mW/cm}^2$, $\lambda = 950\text{ nm}$, $V_R = 5\text{ V}$	I_{ra}	55	80		μA
Temperature coefficient of I_{ra}	$E_e = 1\text{ mW/cm}^2$, $\lambda = 950\text{ nm}$, $V_R = 10\text{ V}$	$TK_{I_{ra}}$		0.1		%/K
Absolute spectral sensitivity	$V_R = 5\text{ V}$, $\lambda = 870\text{ nm}$	$s(\lambda)$		0.35		A/W
	$V_R = 5\text{ V}$, $\lambda = 950\text{ nm}$	$s(\lambda)$		0.6		A/W
Angle of half sensitivity		ϕ		± 60		deg
Wavelength of peak sensitivity		λ_p		950		nm
Range of spectral bandwidth		$\lambda_{0.5}$		870 to 1050		nm
Quantum efficiency	$\lambda = 950\text{ nm}$	η		90		%
Noise equivalent power	$V_R = 10\text{ V}$, $\lambda = 950\text{ nm}$	NEP		4×10^{-14}		$\text{W}/\sqrt{\text{Hz}}$
Detectivity	$V_R = 10\text{ V}$, $\lambda = 950\text{ nm}$	D^*		6×10^{12}		$\text{cm}\sqrt{\text{Hz/W}}$
Rise time	$V_R = 10\text{ V}$, $R_L = 1\text{ k}\Omega$, $\lambda = 820\text{ nm}$	t_r		100		ns
Fall time	$V_R = 10\text{ V}$, $R_L = 1\text{ k}\Omega$, $\lambda = 820\text{ nm}$	t_f		100		ns
Cut-off frequency	$V_R = 12\text{ V}$, $R_L = 1\text{ k}\Omega$, $\lambda = 870\text{ nm}$	f_c		4		MHz
	$V_R = 12\text{ V}$, $R_L = 1\text{ k}\Omega$, $\lambda = 950\text{ nm}$	f_c		1		MHz

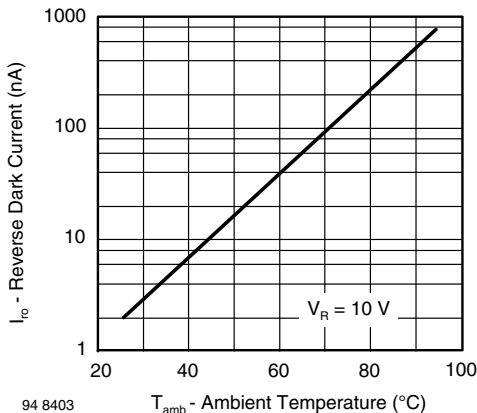
BASIC CHARACTERISTICS ($T_{amb} = 25\text{ }^{\circ}\text{C}$, unless otherwise specified)


Fig. 1 - Reverse Dark Current vs. Ambient Temperature

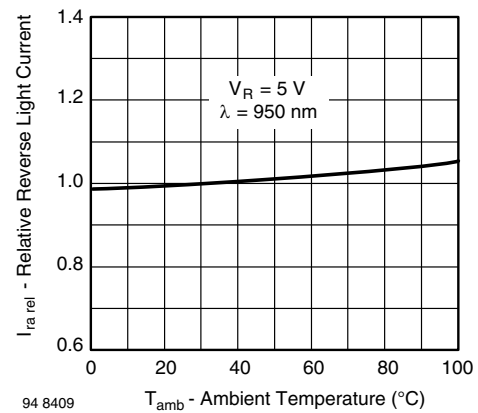


Fig. 2 - Relative Reverse Light Current vs. Ambient Temperature

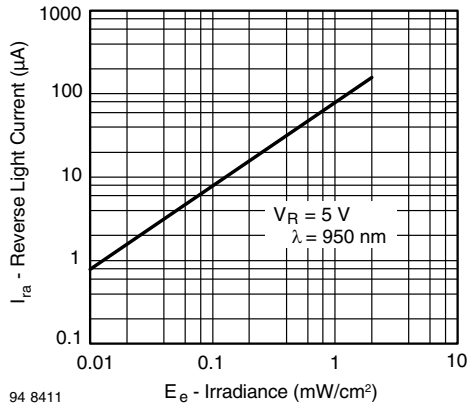


Fig. 3 - Reverse Light Current vs. Irradiance

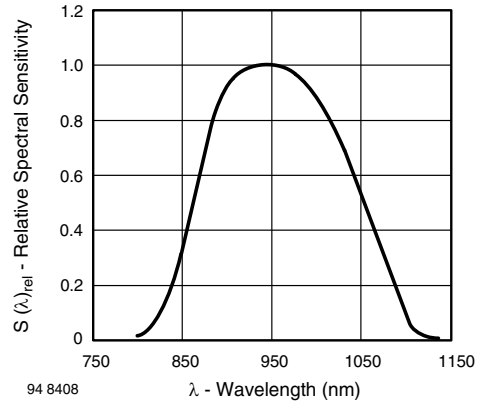


Fig. 6 - Relative Spectral Sensitivity vs. Wavelength

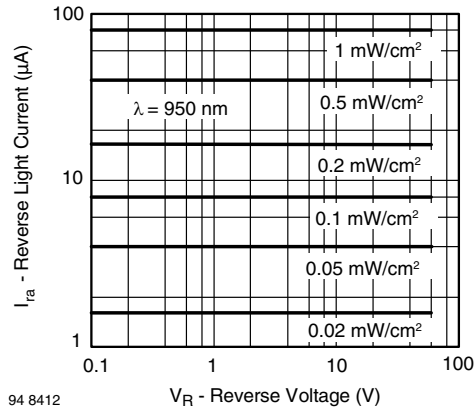


Fig. 4 - Reverse Light Current vs. Reverse Voltage

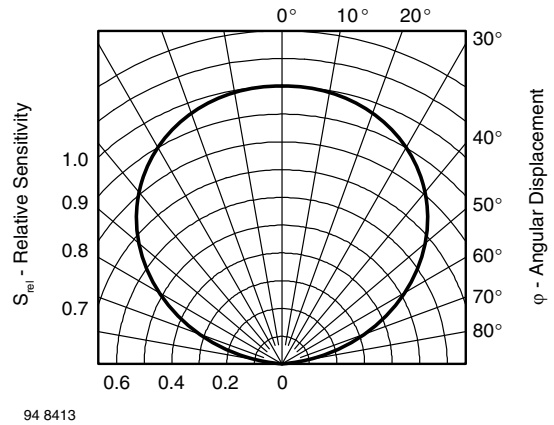


Fig. 7 - Relative Radiant Sensitivity vs. Angular Displacement

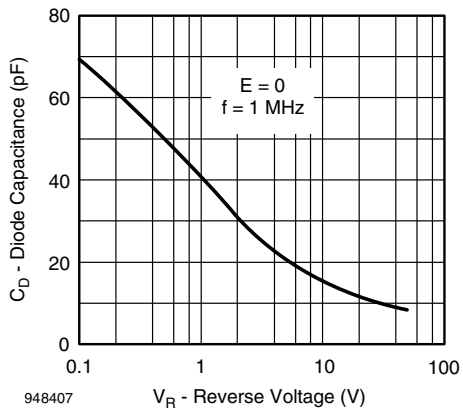
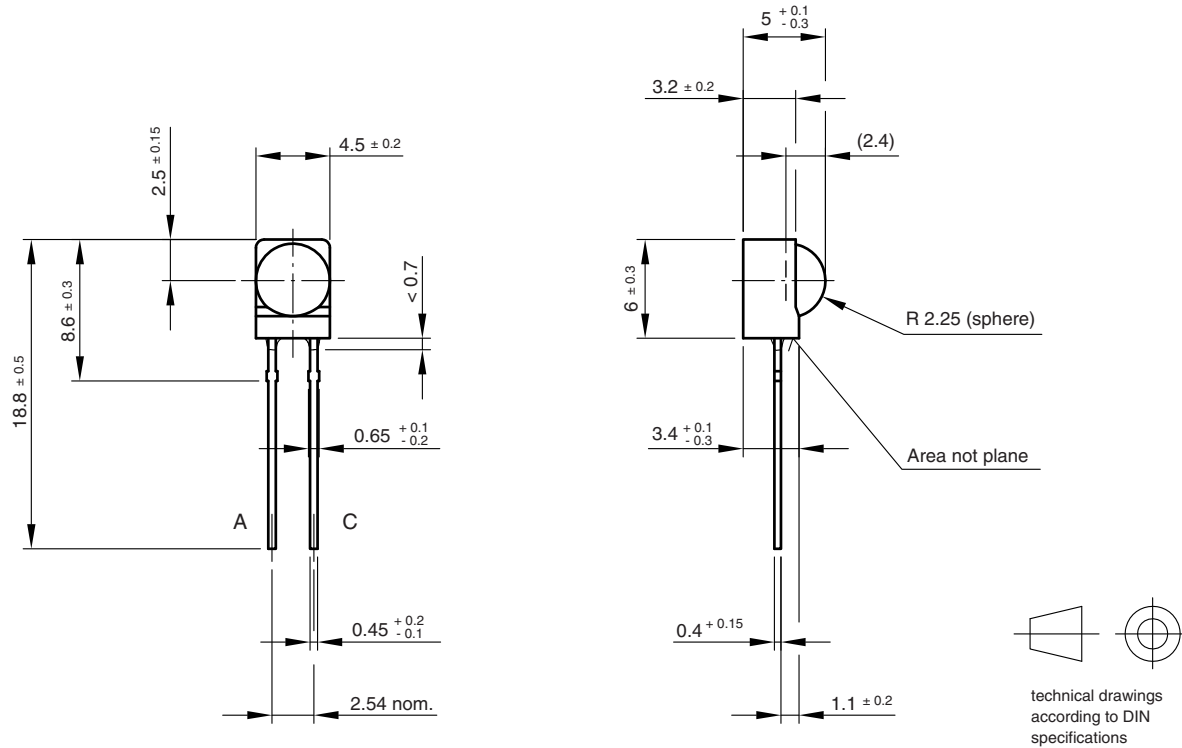


Fig. 5 - Diode Capacitance vs. Reverse Voltage



PACKAGE DIMENSIONS in millimeters



Drawing-No.: 6.544-5199.01-4
Issue: 2; 19.06.01
95 11475



Disclaimer

ALL PRODUCT, PRODUCT SPECIFICATIONS AND DATA ARE SUBJECT TO CHANGE WITHOUT NOTICE TO IMPROVE RELIABILITY, FUNCTION OR DESIGN OR OTHERWISE.

Vishay Intertechnology, Inc., its affiliates, agents, and employees, and all persons acting on its or their behalf (collectively, "Vishay"), disclaim any and all liability for any errors, inaccuracies or incompleteness contained in any datasheet or in any other disclosure relating to any product.

Vishay makes no warranty, representation or guarantee regarding the suitability of the products for any particular purpose or the continuing production of any product. To the maximum extent permitted by applicable law, Vishay disclaims (i) any and all liability arising out of the application or use of any product, (ii) any and all liability, including without limitation special, consequential or incidental damages, and (iii) any and all implied warranties, including warranties of fitness for particular purpose, non-infringement and merchantability.

Statements regarding the suitability of products for certain types of applications are based on Vishay's knowledge of typical requirements that are often placed on Vishay products in generic applications. Such statements are not binding statements about the suitability of products for a particular application. It is the customer's responsibility to validate that a particular product with the properties described in the product specification is suitable for use in a particular application. Parameters provided in datasheets and / or specifications may vary in different applications and performance may vary over time. All operating parameters, including typical parameters, must be validated for each customer application by the customer's technical experts. Product specifications do not expand or otherwise modify Vishay's terms and conditions of purchase, including but not limited to the warranty expressed therein.

Hyperlinks included in this datasheet may direct users to third-party websites. These links are provided as a convenience and for informational purposes only. Inclusion of these hyperlinks does not constitute an endorsement or an approval by Vishay of any of the products, services or opinions of the corporation, organization or individual associated with the third-party website. Vishay disclaims any and all liability and bears no responsibility for the accuracy, legality or content of the third-party website or for that of subsequent links.

Except as expressly indicated in writing, Vishay products are not designed for use in medical, life-saving, or life-sustaining applications or for any other application in which the failure of the Vishay product could result in personal injury or death. Customers using or selling Vishay products not expressly indicated for use in such applications do so at their own risk. Please contact authorized Vishay personnel to obtain written terms and conditions regarding products designed for such applications.

No license, express or implied, by estoppel or otherwise, to any intellectual property rights is granted by this document or by any conduct of Vishay. Product names and markings noted herein may be trademarks of their respective owners.

Looking for pricing, stock, or lifecycle information?

Click below to explore more details on WIN SOURCE:

 [View BPV22F on WIN SOURCE](#)

 [Vishay Information](#)

Optimize Your Supply Chain with WIN SOURCE Solutions

-  Global Sourcing Solution
-  Obsolete Management
-  Cost Control Management
-  Shortage Management
-  Alternative Solution
-  Excess Inventory Management