

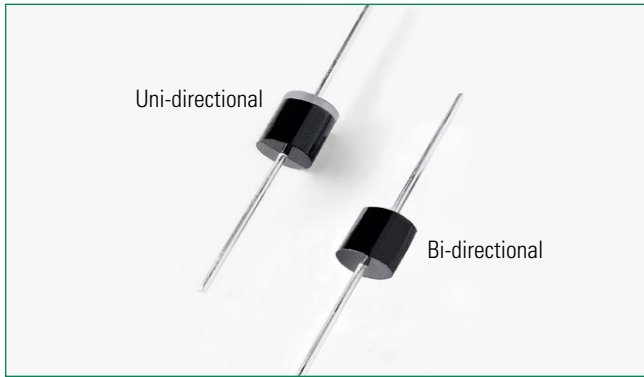

**THE DATASHEET OF
20KPA30CA-B**



20KPA Series



| Agency Approvals | |
|------------------|--------------------|
| Agency | Agency File Number |
| | E230531 |

Maximum Ratings and Thermal Characteristics
(T_A=25°C unless otherwise noted)

| Parameter | Symbol | Value | Unit |
|--|-----------------------------------|------------|------|
| Peak Pulse Power Dissipation by 10/1000µs Test Waveform (Fig.2)(Note 1) | P _{PPM} | 20 | kW |
| Steady State Power Dissipation on Infinite Heat Sink at T _L =75°C | P _D | 8.0 | W |
| Peak Forward Surge Current, 8.3ms Single Half Sine Wave Unidirectional Only (Note 2) | I _{FSM} | 400 | A |
| Operating Junction and Storage Temperature Range | T _J , T _{STG} | -55 to 175 | °C |
| Typical Thermal Resistance Junction to Lead | R _{θJL} | 8.0 | °C/W |
| Typical Thermal Resistance Junction to Ambient | R _{θJA} | 40 | °C/W |

- Notes:**
1. Non-repetitive current pulse, per Fig. 4 and derated above T_J (initial) =25°C per Fig. 3.
 2. Measured on 8.3ms single half sine wave or equivalent square wave, duty cycle=4 per minute maximum.

Functional Diagram

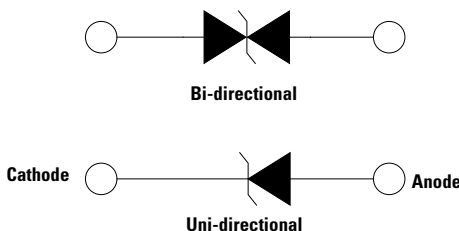

Descriptions

The 20KPA Series is designed specifically to protect sensitive electronic equipment from voltage transients induced by lightning and other transient voltage events.

Features

- 20kW peak pulse capability at 10/1000µs waveform, repetition rate (duty cycles):0.01%
- Glass passivated chip junction in P600 package
- Fast response time: typically less than 1.0ps from 0 Volts to BV min
- Excellent clamping capability
- Typical failure mode is short from over-specified voltage or current
- Whisker test is conducted based on JEDEC JESD201A per its table 4a and 4c
- IEC-61000-4-2 ESD 30kV(Air), 30kV (Contact)
- ESD protection of data lines in accordance with IEC 61000-4-2
- EFT protection of data lines in accordance with IEC 61000-4-4
- Low incremental surge resistance
- Typical I_R less than 2µA when V_{BR} min>49V
- High temperature to reflow soldering guaranteed: 260°C/40sec / 0.375", (9.5mm) lead length, 5 lbs., (2.3kg) tension
- V_{BR} @ T_J= V_{BR} @25°C x (1+ α T x (T_J - 25)) (α T:Temperature Coefficient, typical value is 0.1%)
- UL Recognized compound meeting flammability rating V-0
- Matte tin lead-free plated
- Halogen free and RoHS compliant
- Pb-free E3 means 2nd level interconnect is Pb-free and the terminal finish material is tin(Sn) (IPC/ JEDEC J-STD-609A.01)

Applications

TVS components are ideal for the protection of I/O interfaces, V_{CC} bus and other vulnerable circuits used in telecom, computer, industrial and consumer electronic applications.

Additional Information



Datasheet



Resources



Samples

Electrical Characteristics (T_A=25°C unless otherwise noted)

| Part Number (Uni) | Part Number (Bi) | Reverse Stand off Voltage V _R (Volts) | Breakdown Voltage V _{BR} (Volts) @ I _T | | Test Current I _T (mA) | Maximum Peak Pulse Current I _{PP} (A) | Maximum Reverse Leakage I _R @ V _R (μA) | Maximum Clamping Voltage V _C @ I _{PP} (V) | Agency Recognition  |
|-------------------|------------------|--|--|--------|----------------------------------|--|--|---|--|
| | | | Min. | Max. | | | | | |
| 20KPA20A | 20KPA20CA | 20 | 22.34 | 24.57 | 50 | 548.9 | 5000 | 36.8 | X |
| 20KPA24A | 20KPA24CA | 24 | 26.81 | 29.49 | 50 | 490.3 | 5000 | 41.2 | X |
| 20KPA26A | 20KPA26CA | 26 | 29.04 | 31.94 | 50 | 451.9 | 2000 | 44.7 | X |
| 20KPA28A | 20KPA28CA | 28 | 31.28 | 34.41 | 50 | 420.8 | 1000 | 48.0 | X |
| 20KPA30A | 20KPA30CA | 30 | 33.51 | 36.86 | 5 | 392.2 | 250 | 51.5 | X |
| 20KPA32A | 20KPA32CA | 32 | 35.74 | 39.31 | 5 | 372.0 | 150 | 54.3 | X |
| 20KPA34A | 20KPA34CA | 34 | 38.00 | 41.80 | 5 | 351.3 | 50 | 57.5 | X |
| 20KPA36A | 20KPA36CA | 36 | 40.20 | 44.22 | 5 | 328.5 | 20 | 61.5 | X |
| 20KPA40A | 20KPA40CA | 40 | 44.70 | 49.17 | 5 | 297.9 | 15 | 67.8 | X |
| 20KPA44A | 20KPA44CA | 44 | 49.10 | 54.01 | 5 | 277.9 | 2 | 72.7 | X |
| 20KPA48A | 20KPA48CA | 48 | 53.60 | 58.96 | 5 | 254.4 | 2 | 79.4 | X |
| 20KPA52A | 20KPA52CA | 52 | 58.10 | 63.91 | 5 | 235.4 | 2 | 85.8 | X |
| 20KPA56A | 20KPA56CA | 56 | 62.60 | 68.86 | 5 | 218.1 | 2 | 92.6 | X |
| 20KPA60A | 20KPA60CA | 60 | 67.00 | 73.70 | 5 | 207.0 | 2 | 97.6 | X |
| 20KPA64A | 20KPA64CA | 64 | 71.50 | 78.65 | 5 | 194.2 | 2 | 104.0 | X |
| 20KPA68A | 20KPA68CA | 68 | 76.00 | 83.60 | 5 | 183.6 | 2 | 110.0 | X |
| 20KPA72A | 20KPA72CA | 72 | 80.40 | 88.44 | 5 | 174.1 | 2 | 116.0 | X |
| 20KPA80A | 20KPA80CA | 80 | 89.40 | 98.34 | 5 | 155.4 | 2 | 130.0 | X |
| 20KPA88A | 20KPA88CA | 88 | 98.30 | 108.13 | 5 | 142.3 | 2 | 142.0 | X |
| 20KPA96A | 20KPA96CA | 96 | 107.20 | 117.92 | 5 | 130.3 | 2 | 155.0 | X |
| 20KPA104A | 20KPA104CA | 104 | 116.20 | 127.82 | 5 | 120.2 | 2 | 168.0 | X |
| 20KPA112A | 20KPA112CA | 112 | 125.10 | 137.61 | 5 | 111.0 | 2 | 182.0 | X |
| 20KPA120A | 20KPA120CA | 120 | 134.00 | 147.40 | 5 | 104.1 | 2 | 194.0 | X |
| 20KPA132A | 20KPA132CA | 132 | 147.40 | 162.14 | 5 | 94.8 | 2 | 213.0 | X |
| 20KPA144A | 20KPA144CA | 144 | 160.80 | 176.88 | 5 | 87.1 | 2 | 232.0 | X |
| 20KPA160A | 20KPA160CA | 160 | 178.70 | 196.57 | 5 | 78.3 | 2 | 258.0 | X |
| 20KPA172A | 20KPA172CA | 172 | 192.10 | 211.31 | 5 | 72.9 | 2 | 277.0 | X |
| 20KPA180A | 20KPA180CA | 180 | 201.10 | 221.21 | 5 | 69.4 | 2 | 291.0 | X |
| 20KPA192A | 20KPA192CA | 192 | 214.50 | 235.95 | 5 | 65.4 | 2 | 309.0 | X |
| 20KPA204A | 20KPA204CA | 204 | 227.90 | 250.69 | 5 | 61.4 | 2 | 329.0 | X |
| 20KPA216A | 20KPA216CA | 216 | 241.30 | 265.43 | 5 | 58.0 | 2 | 348.0 | X |
| 20KPA232A | 20KPA232CA | 232 | 259.10 | 285.01 | 5 | 54.0 | 2 | 374.0 | X |
| 20KPA240A | 20KPA240CA | 240 | 268.10 | 294.91 | 5 | 52.2 | 2 | 387.0 | X |
| 20KPA256A | 20KPA256CA | 256 | 286.00 | 314.60 | 5 | 49.0 | 2 | 412.0 | X |
| 20KPA280A | 20KPA280CA | 280 | 312.80 | 344.08 | 5 | 44.8 | 2 | 451.0 | X |
| 20KPA300A | 20KPA300CA | 300 | 335.10 | 368.61 | 5 | 41.8 | 2 | 483.0 | X |

For bidirectional type having V_{RWM} of 40 volts and less, the I_T limit is double.

For parts without A, the V_{BR} is ± 10% and V_C is 5% higher than with A parts, the parts without A are currently available, but not recommended for new designs. The parts with A are preferred.

I-V Curve Characteristics

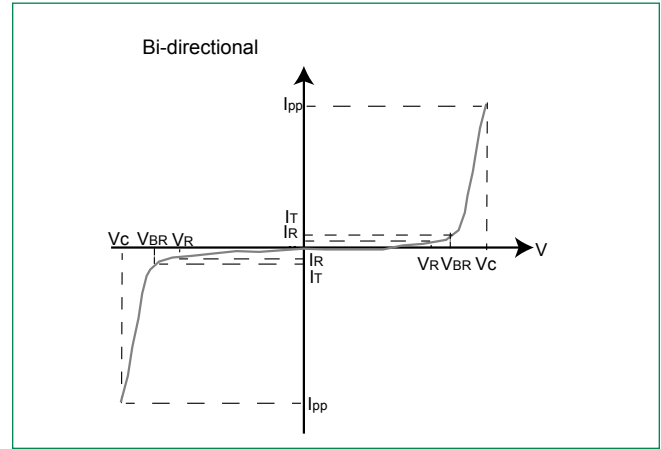
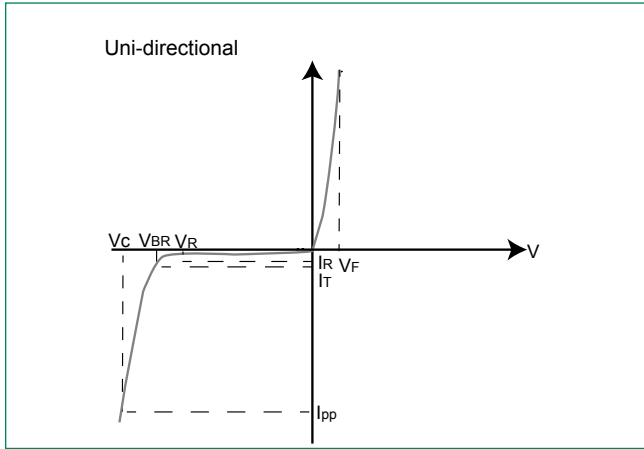

- P_{PPM} Peak Pulse Power Dissipation** – Max power dissipation
- V_R Stand-off Voltage** – Maximum voltage that can be applied to the TVS without operation
- V_{BR} Breakdown Voltage** – Maximum voltage that flows through the TVS at a specified test current (I_T)
- V_C Clamping Voltage** – Peak voltage measured across the TVS at a specified I_{ppm} (peak impulse current)
- I_R Reverse Leakage Current** – Current measured at V_R
- V_F Forward Voltage Drop for Uni-directional**

Ratings and Characteristic Curves ($T_A=25^\circ\text{C}$ unless otherwise noted)

Figure 1 - TVS Transients Clamping Waveform

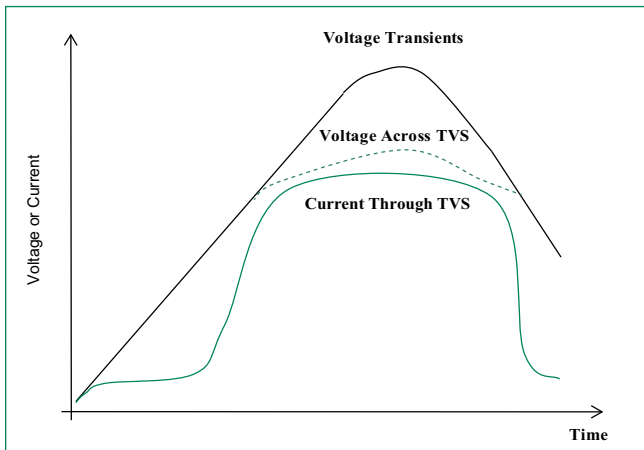
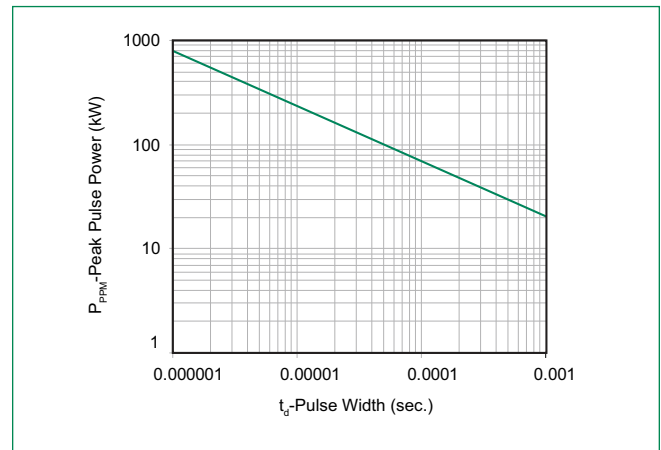

Figure 2 - Peak Pulse Power Rating Curve



Ratings and Characteristic Curves ($T_A=25^\circ\text{C}$ unless otherwise noted) (Continued)

Figure 3 - Peak Pulse Power Derating Curve

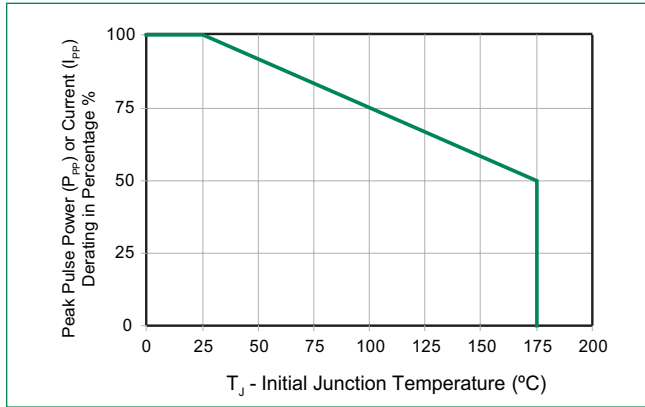

Figure 4 - Pulse Waveform

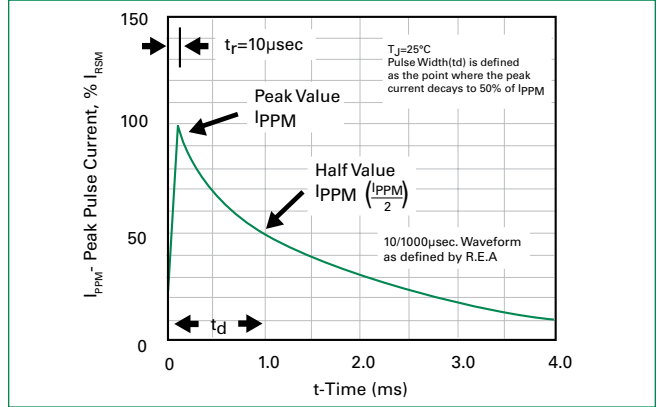

Figure 5 - Typical Junction Capacitance

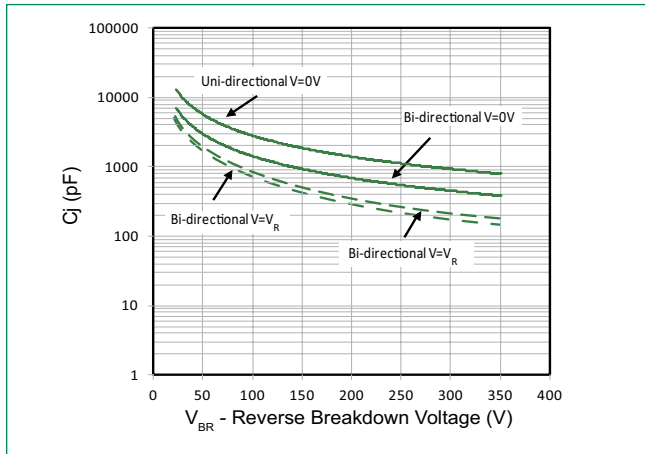

Figure 6 - Typical Transient Thermal Impedance

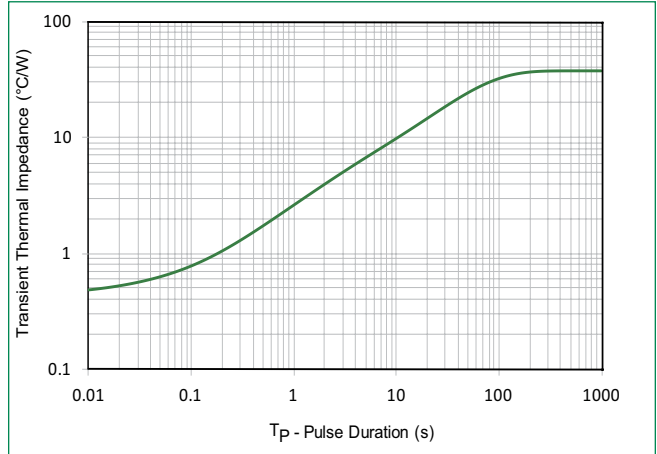

Figure 7 - Maximum Non-Repetitive Peak Forward Surge Current Uni-Directional Only

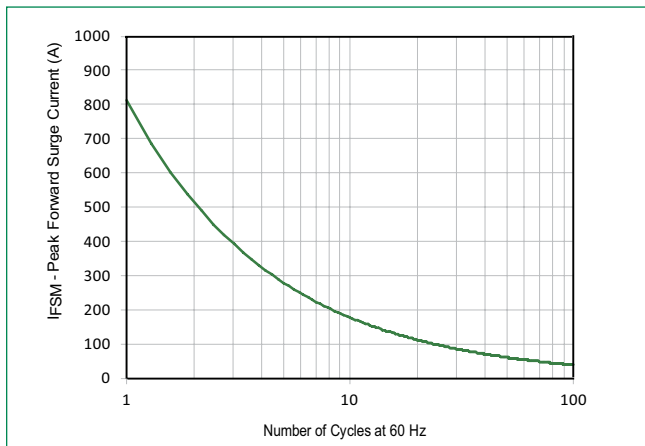
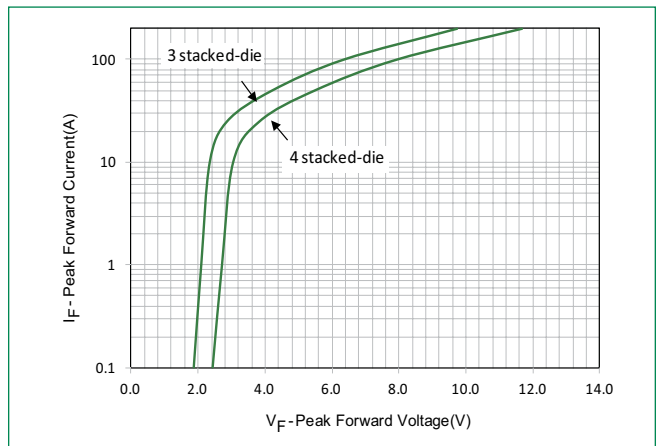
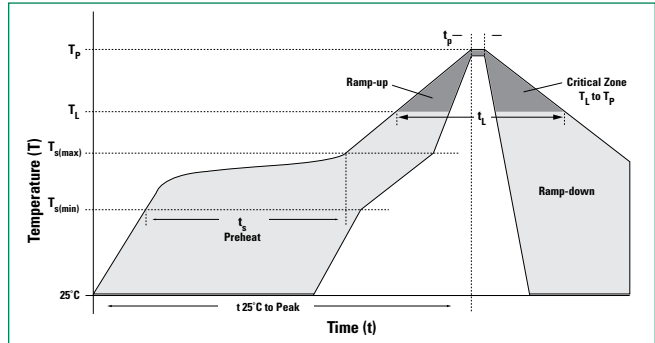

Figure 8 - Peak Forward Voltage Drop vs Peak Forward Current (Typical Values)



Soldering Parameter

| | | |
|---|------------------------------------|-------------------------|
| Reflow Condition | | Lead-free assembly |
| Pre Heat | - Temperature Min ($T_{s(min)}$) | 150°C |
| | - Temperature Max ($T_{s(max)}$) | 200°C |
| | - Time (min to max) (t_s) | 60 – 180 secs |
| Average ramp up rate (Liquidus Temp (T_A) to peak | | 3°C/second max |
| $T_{s(max)}$ to T_A - Ramp-up Rate | | 3°C/second max |
| Reflow | - Temperature (T_A) (Liquidus) | 217°C |
| | - Time (min to max) (t_s) | 60 – 150 seconds |
| Peak Temperature (T_p) | | 260 ^{+0/-5} °C |
| Time within 5°C of actual peak Temperature (t_p) | | 20 – 40 seconds |
| Ramp-down Rate | | 6°C/second max |
| Time 25°C to peak Temperature (T_p) | | 8 minutes Max. |
| Do not exceed | | 210°C |



Flow/Wave Soldering (Solder Dipping)

| | |
|---------------------------|------------|
| Peak Temperature : | 265°C |
| Dipping Time : | 10 seconds |
| Soldering : | 1 time |

Physical Specifications

| | |
|-----------------|--|
| Weight | 0.07oz., 2.5g |
| Case | P600 molded plastic body over passivated junction. |
| Polarity | Color band denotes the cathode except Bipolar. |
| Terminal | Matte Tin axial leads, solderable per JESD22-B102. |

Environmental Specifications

| | |
|----------------------------|-------------|
| High Temp. Storage | JESD22-A103 |
| HTRB | JESD22-A108 |
| Temperature Cycling | JESD22-A104 |
| H3TRB | JESD22-A101 |
| RSH | JESD22-B106 |

Dimensions

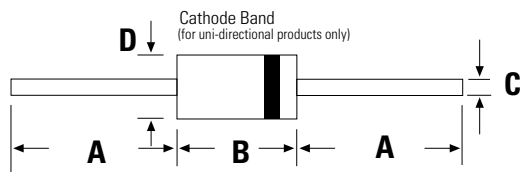

P600

| Dimensions | Inches | | Millimeters | |
|------------|--------|-------|-------------|------|
| | Min | Max | Min | Max |
| A | 1.000 | - | 25.40 | - |
| B | 0.340 | 0.360 | 8.60 | 9.10 |
| C | 0.048 | 0.054 | 1.22 | 1.36 |
| D | 0.340 | 0.360 | 8.60 | 9.10 |

Part Numbering System

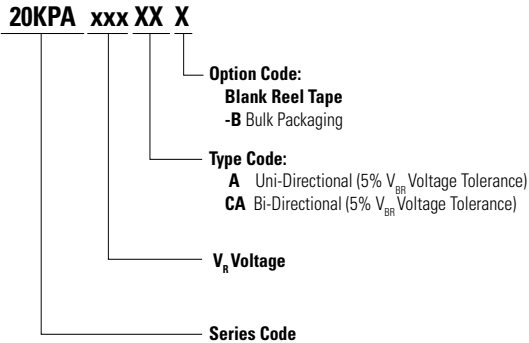

Part Marking System

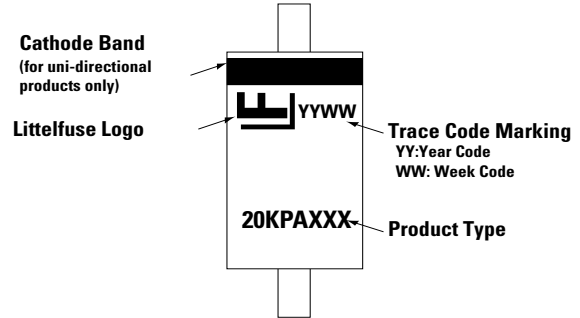

Packing Options

| Part Number | Component Package | Quantity | Packaging Option | Packaging Specification |
|--------------|-------------------|----------|------------------|-------------------------|
| 20KPAxxxXX | P600 | 800 | Tape & Reel | EIA STD RS-296 |
| 20KPAxxxXX-B | P600 | 100 | Bulk | Littelfuse Spec. |

Tape and Reel Specification

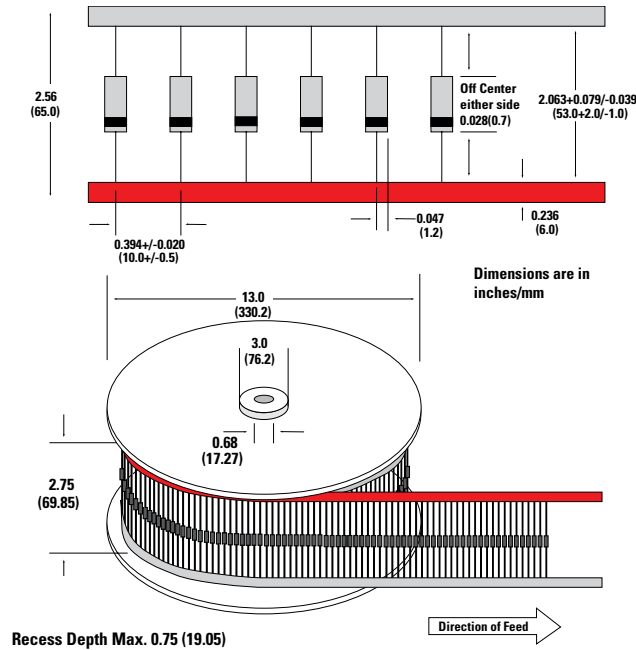

Looking for pricing, stock, or lifecycle information?

Click below to explore more details on WIN SOURCE:

 [View 20KPA30CA-B on WIN SOURCE](#)

 [Littelfuse Inc. Information](#)

Optimize Your Supply Chain with WIN SOURCE Solutions

-  Global Sourcing Solution
-  Obsolete Management
-  Cost Control Management
-  Shortage Management
-  Alternative Solution
-  Excess Inventory Management