



THE DATASHEET OF 2N7002/HAMR





2N7002

60 V, 300 mA N-channel Trench MOSFET

Rev. 7 — 8 September 2011

Product data sheet

1. Product profile

1.1 General description

N-channel enhancement mode Field-Effect Transistor (FET) in a plastic package using Trench MOSFET technology.

1.2 Features and benefits

- Suitable for logic level gate drive sources
- Very fast switching
- Surface-mounted package
- Trench MOSFET technology

1.3 Applications

- Logic level translators
- High-speed line drivers

1.4 Quick reference data

Table 1. Quick reference data

Symbol	Parameter	Conditions	Min	Typ	Max	Unit
V_{DS}	drain-source voltage	$25\text{ °C} \leq T_j \leq 150\text{ °C}$	-	-	60	V
I_D	drain current	$V_{GS} = 10\text{ V}$; $T_{sp} = 25\text{ °C}$; see Figure 1 ; see Figure 3	-	-	300	mA
P_{tot}	total power dissipation	$T_{sp} = 25\text{ °C}$; see Figure 2	-	-	0.83	W
Static characteristics						
$R_{DS(on)}$	drain-source on-state resistance	$V_{GS} = 10\text{ V}$; $I_D = 500\text{ mA}$; $T_j = 25\text{ °C}$; see Figure 6 ; see Figure 8	-	2.8	5	Ω

2. Pinning information

Table 2. Pinning information

Pin	Symbol	Description	Simplified outline	Graphic symbol
1	G	gate	 SOT23 (TO-236AB)	 mbb076
2	S	source		
3	D	drain		

3. Ordering information

Table 3. Ordering information

Type number	Package		Version
	Name	Description	
2N7002	TO-236AB	plastic surface-mounted package; 3 leads	SOT23

4. Marking

Table 4. Marking codes

Type number	Marking code ^[1]
2N7002	12%

[1] % = placeholder for manufacturing site code

5. Limiting values

Table 5. Limiting values

In accordance with the Absolute Maximum Rating System (IEC 60134).

Symbol	Parameter	Conditions	Min	Max	Unit
V_{DS}	drain-source voltage	$25\text{ °C} \leq T_j \leq 150\text{ °C}$	-	60	V
V_{DGR}	drain-gate voltage	$25\text{ °C} \leq T_j \leq 150\text{ °C}$; $R_{GS} = 20\text{ k}\Omega$	-	60	V
V_{GS}	gate-source voltage		-30	30	V
V_{GSM}	peak gate-source voltage	pulsed; $t_p \leq 50\text{ }\mu\text{s}$; $\delta = 0.25$	-40	40	V
I_D	drain current	$V_{GS} = 10\text{ V}$; $T_{sp} = 25\text{ °C}$; see Figure 1 ; see Figure 3	-	300	mA
		$V_{GS} = 10\text{ V}$; $T_{sp} = 100\text{ °C}$; see Figure 1	-	190	mA
I_{DM}	peak drain current	pulsed; $t_p \leq 10\text{ }\mu\text{s}$; $T_{sp} = 25\text{ °C}$; see Figure 3	-	1.2	A
P_{tot}	total power dissipation	$T_{sp} = 25\text{ °C}$; see Figure 2	-	0.83	W
T_j	junction temperature		-65	150	°C
T_{stg}	storage temperature		-65	150	°C
Source-drain diode					
I_S	source current	$T_{sp} = 25\text{ °C}$	-	300	mA
I_{SM}	peak source current	pulsed; $t_p \leq 10\text{ }\mu\text{s}$; $T_{sp} = 25\text{ °C}$	-	1.2	A

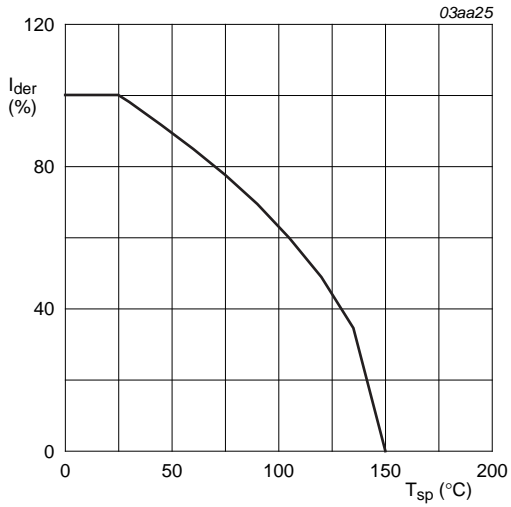

$$I_{der} = \frac{I_D}{I_{D(25^\circ\text{C})}} \times 100\%$$

Fig 1. Normalized continuous drain current as a function of solder point temperature

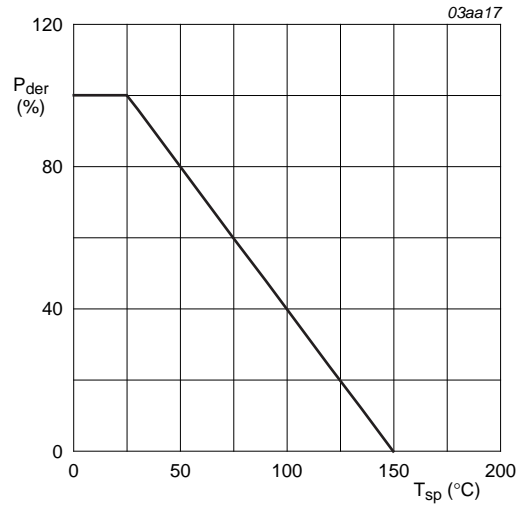

$$P_{der} = \frac{P_{tot}}{P_{tot(25^\circ\text{C})}} \times 100\%$$

Fig 2. Normalized total power dissipation as a function of solder point temperature

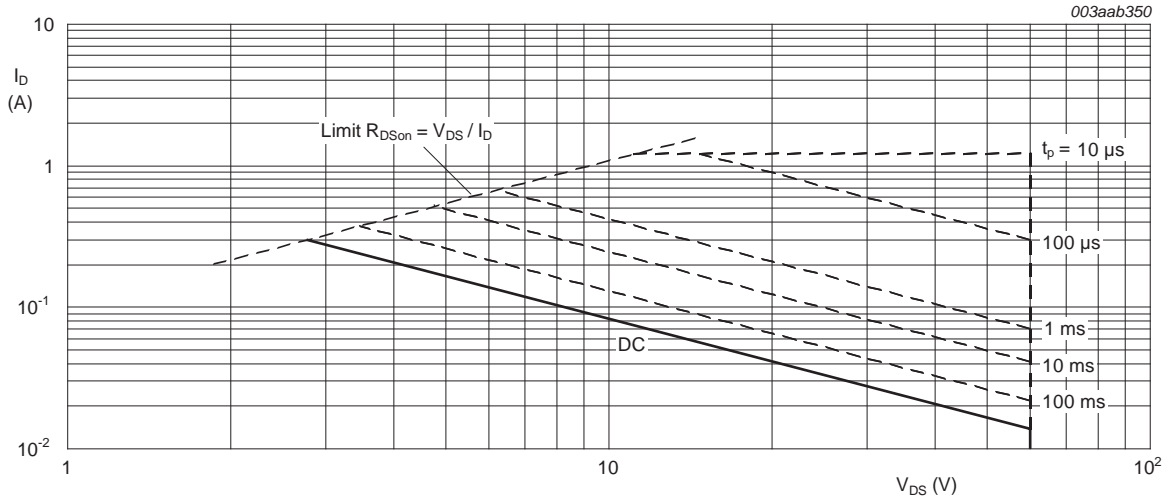

$T_{sp} = 25^\circ\text{C}; I_{DM}$ is single pulse

Fig 3. Safe operating area; continous and peak drain currents as a function of drain-source voltage

6. Thermal characteristics

Table 6. Thermal characteristics

Symbol	Parameter	Conditions	Min	Typ	Max	Unit
$R_{th(j-a)}$	thermal resistance from junction to ambient	Mounted on a printed-circuit board; minimum footprint ; vertical in still air	-	-	350	K/W
$R_{th(j-sp)}$	thermal resistance from junction to solder point	see Figure 4	-	-	150	K/W

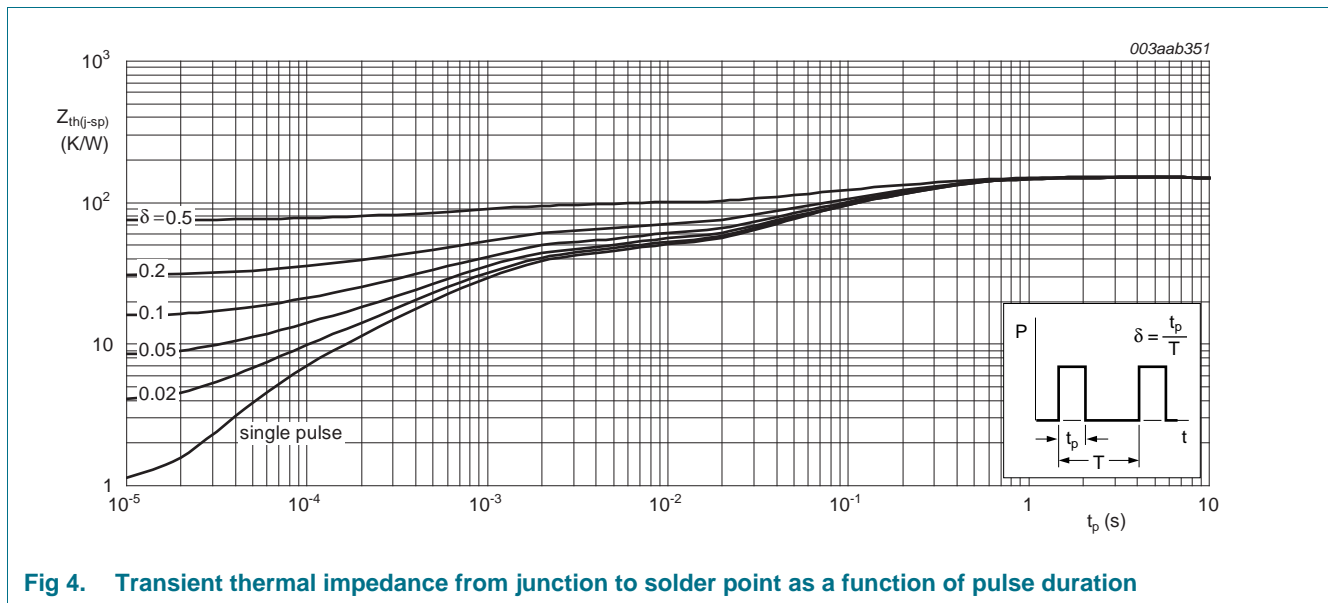

Fig 4. Transient thermal impedance from junction to solder point as a function of pulse duration

7. Characteristics

Table 7. Characteristics

Symbol	Parameter	Conditions	Min	Typ	Max	Unit
Static characteristics						
$V_{(BR)DSS}$	drain-source breakdown voltage	$I_D = 10 \mu\text{A}; V_{GS} = 0 \text{ V}; T_j = 25 \text{ }^\circ\text{C}$	60	-	-	V
		$I_D = 10 \mu\text{A}; V_{GS} = 0 \text{ V}; T_j = -55 \text{ }^\circ\text{C}$	55	-	-	V
V_{GSth}	gate-source threshold voltage	$I_D = 0.25 \text{ mA}; V_{DS} = V_{GS}; T_j = 25 \text{ }^\circ\text{C};$ see Figure 9 ; see Figure 10	1	2	2.5	V
		$I_D = 0.25 \text{ mA}; V_{DS} = V_{GS}; T_j = 150 \text{ }^\circ\text{C};$ see Figure 9 ; see Figure 10	0.6	-	-	V
		$I_D = 0.25 \text{ mA}; V_{DS} = V_{GS}; T_j = -55 \text{ }^\circ\text{C};$ see Figure 9 ; see Figure 10	-	-	2.75	V
I_{DSS}	drain leakage current	$V_{DS} = 48 \text{ V}; V_{GS} = 0 \text{ V}; T_j = 25 \text{ }^\circ\text{C}$	-	0.01	1	μA
		$V_{DS} = 48 \text{ V}; V_{GS} = 0 \text{ V}; T_j = 150 \text{ }^\circ\text{C}$	-	-	10	μA
I_{GSS}	gate leakage current	$V_{GS} = 15 \text{ V}; V_{DS} = 0 \text{ V}; T_j = 25 \text{ }^\circ\text{C}$	-	10	100	nA
		$V_{GS} = -15 \text{ V}; V_{DS} = 0 \text{ V}; T_j = 25 \text{ }^\circ\text{C}$	-	10	100	nA
R_{DSon}	drain-source on-state resistance	$V_{GS} = 10 \text{ V}; I_D = 500 \text{ mA}; T_j = 25 \text{ }^\circ\text{C};$ see Figure 6 ; see Figure 8	-	2.8	5	Ω
		$V_{GS} = 10 \text{ V}; I_D = 500 \text{ mA}; T_j = 150 \text{ }^\circ\text{C};$ see Figure 6 ; see Figure 8	-	-	9.25	Ω
		$V_{GS} = 4.5 \text{ V}; I_D = 75 \text{ mA}; T_j = 25 \text{ }^\circ\text{C};$ see Figure 6 ; see Figure 8	-	3.8	5.3	Ω
Dynamic characteristics						
C_{iss}	input capacitance	$V_{DS} = 10 \text{ V}; f = 1 \text{ MHz}; V_{GS} = 0 \text{ V};$ $T_j = 25 \text{ }^\circ\text{C}$	-	31	50	pF
C_{oss}	output capacitance		-	6.8	30	pF
C_{rss}	reverse transfer capacitance		-	3.5	10	pF
t_{on}	turn-on time	$V_{GS} = 10 \text{ V}; V_{DS} = 50 \text{ V}; R_L = 250 \text{ } \Omega;$ $R_{G(ext)} = 50 \text{ } \Omega; R_{GS} = 50 \text{ } \Omega$	-	2.5	10	ns
t_{off}	turn-off time		-	11	15	ns
Source-drain diode						
V_{SD}	source-drain voltage	$I_S = 300 \text{ mA}; V_{GS} = 0 \text{ V}; T_j = 25 \text{ }^\circ\text{C};$ see Figure 11	-	0.85	1.5	V
Q_r	recovered charge	$V_{GS} = 0 \text{ V}; I_S = 300 \text{ mA};$ $di_S/dt = -100 \text{ A}/\mu\text{s}$	-	30	-	nC
t_{rr}	reverse recovery time		-	30	-	ns

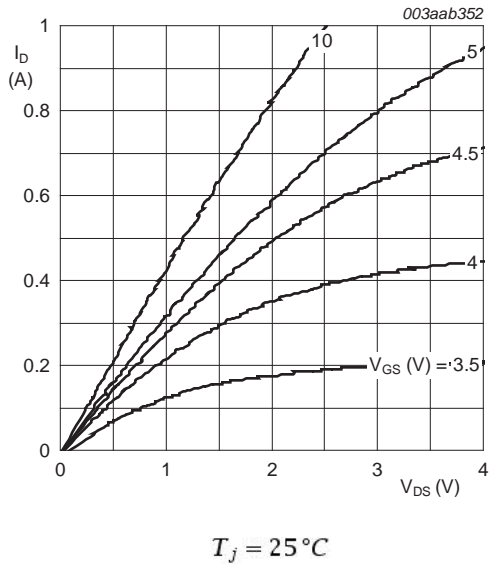

Fig 5. Output characteristics: drain current as a function of drain-source voltage; typical values

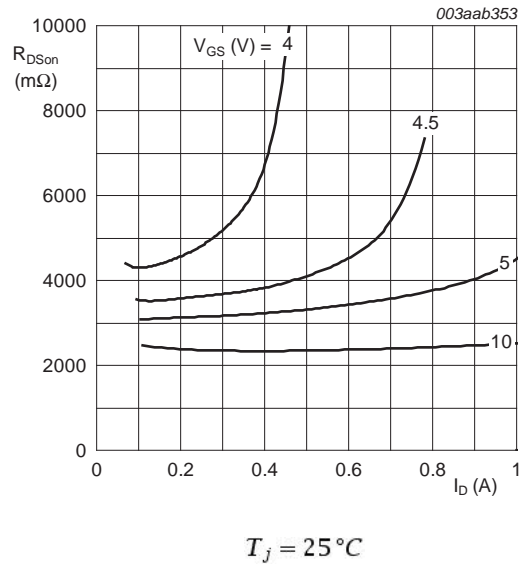

Fig 6. Drain-source on-state resistance as a function of drain current; typical values

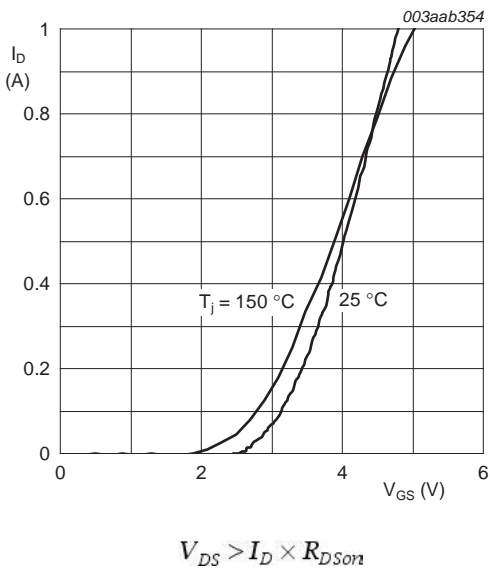

Fig 7. Transfer characteristics: drain current as a function of gate-source voltage; typical values

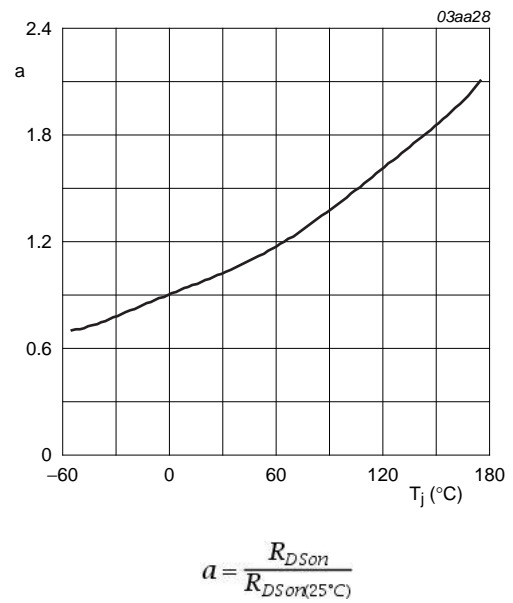

Fig 8. Normalized drain-source on-state resistance factor as a function of junction temperature

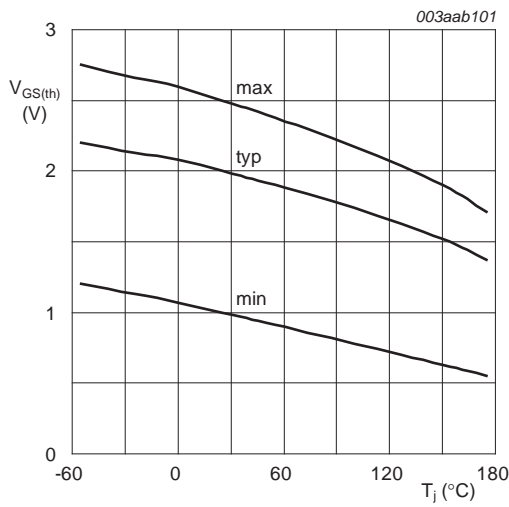

Fig 9. Gate-source threshold voltage as a function of junction temperature

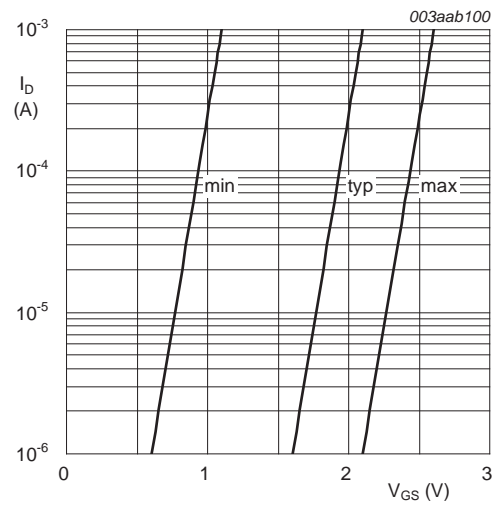

Fig 10. Sub-threshold drain current as a function of gate-source voltage

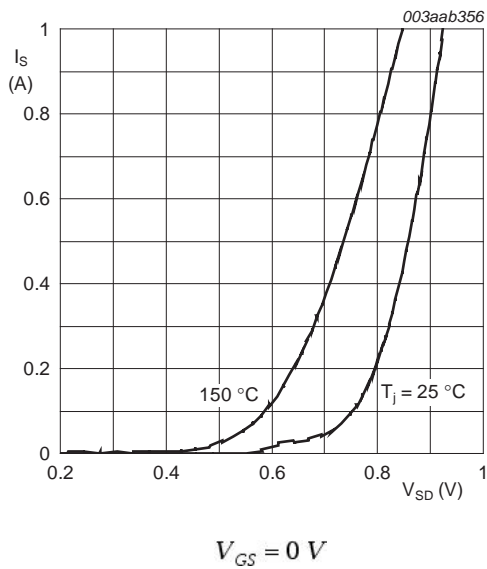

Fig 11. Source current as a function of source-drain voltage; typical values

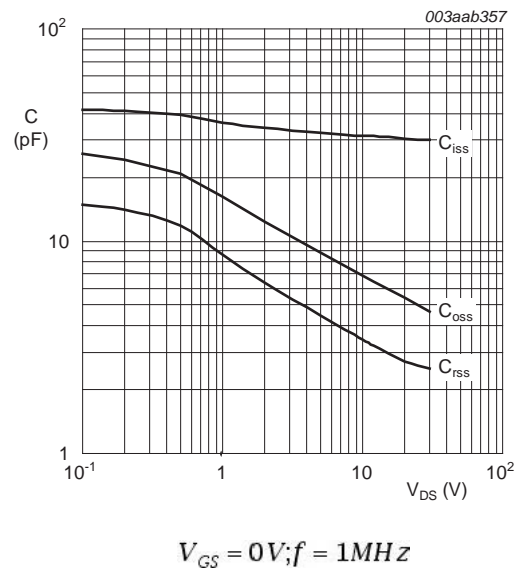

Fig 12. Input, output and reverse transfer capacitances as a function of drain-source voltage; typical values

8. Package outline

Plastic surface-mounted package; 3 leads

SOT23

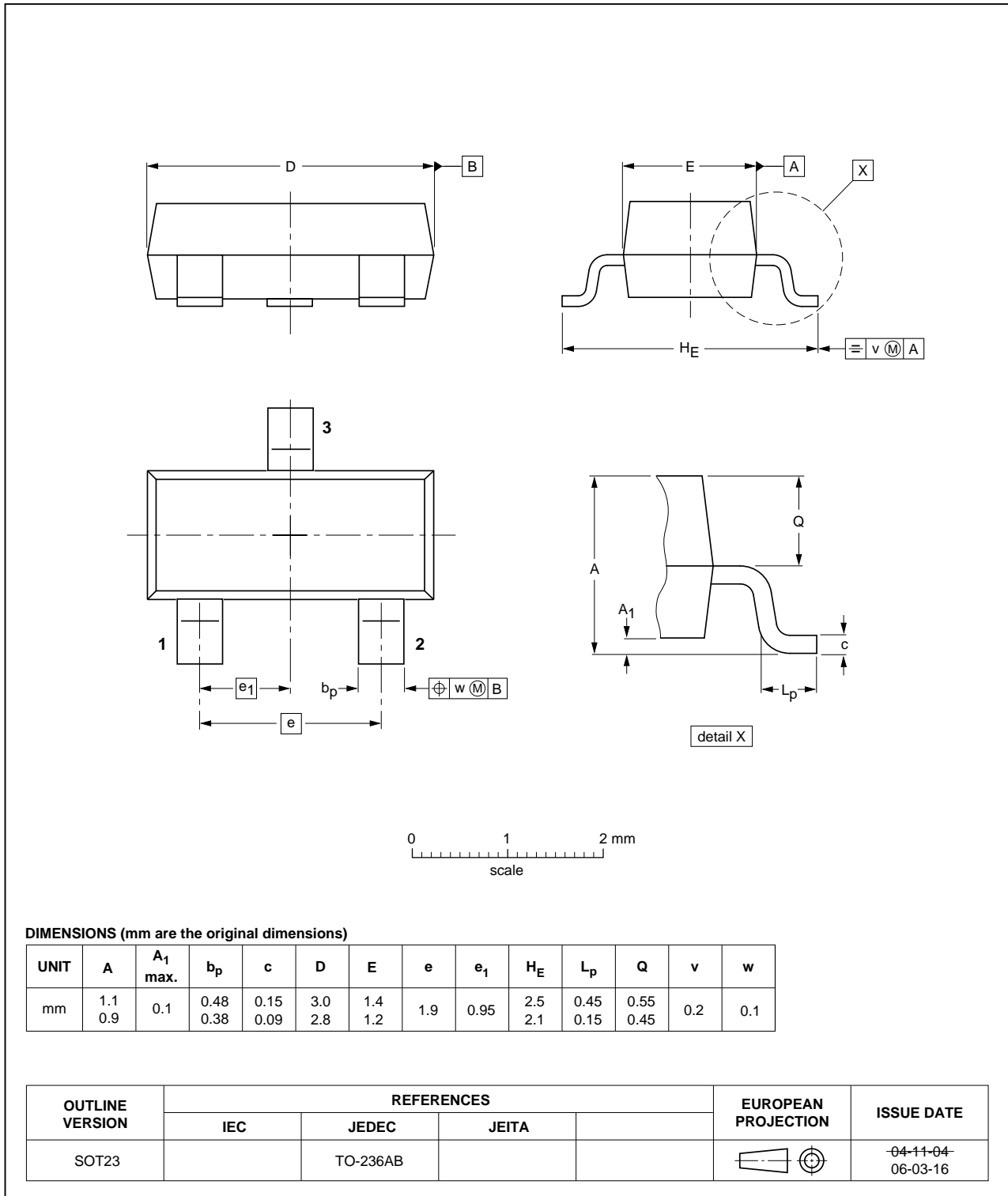

Fig 13. Package outline SOT23 (TO-236AB)

9. Soldering

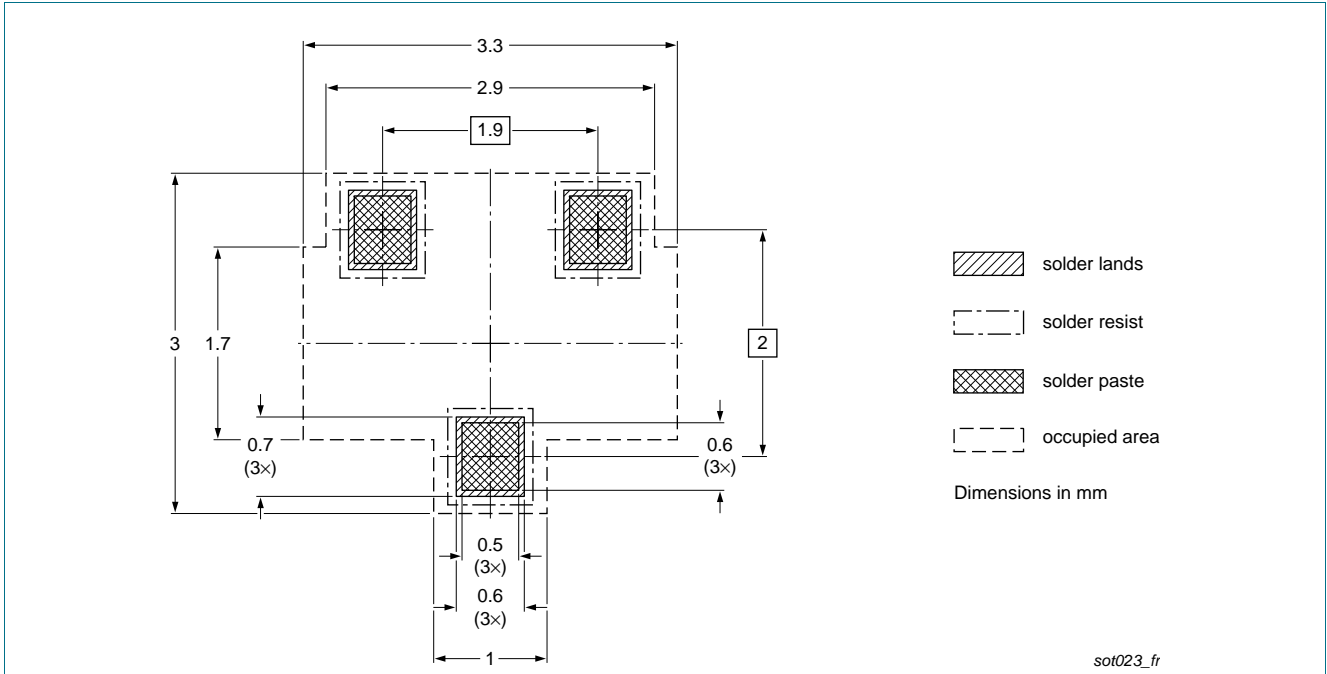

Fig 14. Reflow soldering footprint for SOT23 (TO-236AB)

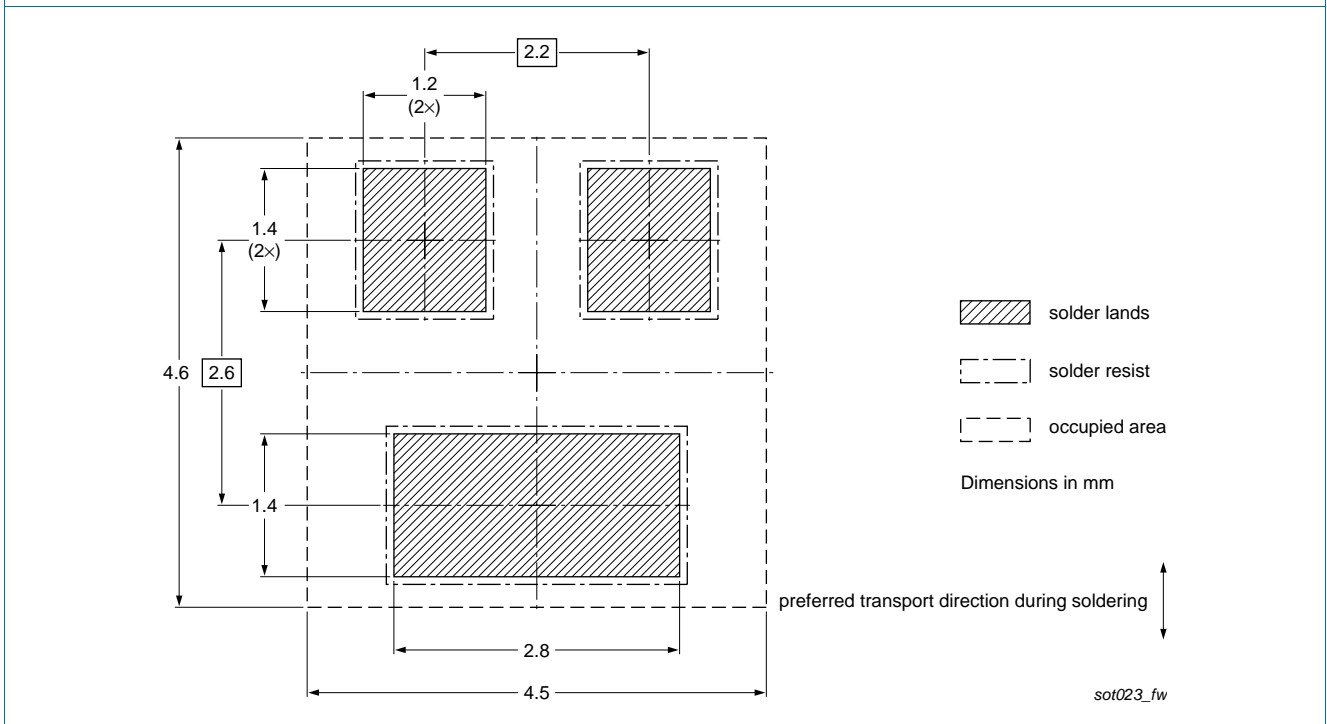

Fig 15. Wave soldering footprint for SOT23 (TO-236AB)

10. Revision history

Table 8. Revision history

Document ID	Release date	Data sheet status	Change notice	Supersedes
2N7002 v.7	20110908	Product data sheet	-	2N7002 v.6
Modifications:	<ul style="list-style-type: none">• The format of this data sheet has been redesigned to comply with the new identity guidelines of NXP Semiconductors.• Legal texts have been adapted to the new company name where appropriate.			
2N7002 v.6	20060428	Product data sheet		2N7002 v.5
2N7002 v.5	20051115	Product data sheet		2N7002 v.4
2N7002 v.4	20050426	Product data sheet		2N7002 v.3
2N7002 v.3	20000727	Product specification	HZG336	2N7002 v.2
2N7002 v.2	19970617	Product specification		2N7002 v.1
2N7002 v.1	19901031	Product specification	-	-

11. Legal information

11.1 Data sheet status

Document status ^[1] ^[2]	Product status ^[3]	Definition
Objective [short] data sheet	Development	This document contains data from the objective specification for product development.
Preliminary [short] data sheet	Qualification	This document contains data from the preliminary specification.
Product [short] data sheet	Production	This document contains the product specification.

[1] Please consult the most recently issued document before initiating or completing a design.

[2] The term 'short data sheet' is explained in section "Definitions".

[3] The product status of device(s) described in this document may have changed since this document was published and may differ in case of multiple devices. The latest product status information is available on the Internet at URL <http://www.nexperia.com>.

11.2 Definitions

Preview — The document is a preview version only. The document is still subject to formal approval, which may result in modifications or additions. Nexperia does not give any representations or warranties as to the accuracy or completeness of information included herein and shall have no liability for the consequences of use of such information.

Draft — The document is a draft version only. The content is still under internal review and subject to formal approval, which may result in modifications or additions. Nexperia does not give any representations or warranties as to the accuracy or completeness of information included herein and shall have no liability for the consequences of use of such information.

Short data sheet — A short data sheet is an extract from a full data sheet with the same product type number(s) and title. A short data sheet is intended for quick reference only and should not be relied upon to contain detailed and full information. For detailed and full information see the relevant full data sheet, which is available on request via the local Nexperia sales office. In case of any inconsistency or conflict with the short data sheet, the full data sheet shall prevail.

Product specification — The information and data provided in a Product data sheet shall define the specification of the product as agreed between Nexperia and its customer, unless Nexperia and customer have explicitly agreed otherwise in writing. In no event however, shall an agreement be valid in which the Nexperia product is deemed to offer functions and qualities beyond those described in the Product data sheet.

11.3 Disclaimers

Limited warranty and liability — Information in this document is believed to be accurate and reliable. However, Nexperia does not give any representations or warranties, expressed or implied, as to the accuracy or completeness of such information and shall have no liability for the consequences of use of such information.

In no event shall Nexperia be liable for any indirect, incidental, punitive, special or consequential damages (including - without limitation - lost profits, lost savings, business interruption, costs related to the removal or replacement of any products or rework charges) whether or not such damages are based on tort (including negligence), warranty, breach of contract or any other legal theory.

Notwithstanding any damages that customer might incur for any reason whatsoever, Nexperia's aggregate and cumulative liability towards customer for the products described herein shall be limited in accordance with the *Terms and conditions of commercial sale* of Nexperia.

Right to make changes — Nexperia reserves the right to make changes to information published in this document, including without limitation specifications and product descriptions, at any time and without notice. This document supersedes and replaces all information supplied prior to the publication hereof.

Suitability for use — Nexperia products are not designed, authorized or warranted to be suitable for use in life support, life-critical or safety-critical systems or equipment, nor in applications where failure or malfunction of a Nexperia product can reasonably be expected to result in personal injury, death or severe property or environmental damage. Nexperia accepts no liability for inclusion and/or use of Nexperia products in such equipment or applications and therefore such inclusion and/or use is at the customer's own risk.

Quick reference data — The Quick reference data is an extract of the product data given in the Limiting values and Characteristics sections of this document, and as such is not complete, exhaustive or legally binding.

Applications — Applications that are described herein for any of these products are for illustrative purposes only. Nexperia makes no representation or warranty that such applications will be suitable for the specified use without further testing or modification.

Customers are responsible for the design and operation of their applications and products using Nexperia products, and Nexperia accepts no liability for any assistance with applications or customer product design. It is customer's sole responsibility to determine whether the Nexperia product is suitable and fit for the customer's applications and products planned, as well as for the planned application and use of customer's third party customer(s). Customers should provide appropriate design and operating safeguards to minimize the risks associated with their applications and products.

Nexperia does not accept any liability related to any default, damage, costs or problem which is based on any weakness or default in the customer's applications or products, or the application or use by customer's third party customer(s). Customer is responsible for doing all necessary testing for the customer's applications and products using Nexperia products in order to avoid a default of the applications and the products or of the application or use by customer's third party customer(s). Nexperia does not accept any liability in this respect.

Limiting values — Stress above one or more limiting values (as defined in the Absolute Maximum Ratings System of IEC 60134) will cause permanent damage to the device. Limiting values are stress ratings only and (proper) operation of the device at these or any other conditions above those given in the Recommended operating conditions section (if present) or the Characteristics sections of this document is not warranted. Constant or repeated exposure to limiting values will permanently and irreversibly affect the quality and reliability of the device.

Terms and conditions of commercial sale — Nexperia products are sold subject to the general terms and conditions of commercial sale, as published at <http://www.nexperia.com/profile/terms>, unless otherwise agreed in a valid written individual agreement. In case an individual agreement is concluded only the terms and conditions of the respective agreement shall apply. Nexperia hereby expressly objects to applying the customer's general terms and conditions with regard to the purchase of Nexperia products by customer.

No offer to sell or license — Nothing in this document may be interpreted or construed as an offer to sell products that is open for acceptance or the grant, conveyance or implication of any license under any copyrights, patents or other industrial or intellectual property rights.

Export control — This document as well as the item(s) described herein may be subject to export control regulations. Export might require a prior authorization from national authorities.

Non-automotive qualified products — Unless this data sheet expressly states that this specific Nexperia product is automotive qualified, the product is not suitable for automotive use. It is neither qualified nor tested in accordance with automotive testing or application requirements. Nexperia accepts no liability for inclusion and/or use of non-automotive qualified products in automotive equipment or applications.

In the event that customer uses the product for design-in and use in automotive applications to automotive specifications and standards, customer (a) shall use the product without Nexperia's warranty of the product for such automotive applications, use and specifications, and (b) whenever customer uses the product for automotive applications beyond Nexperia's specifications such use shall be solely at customer's own risk, and (c) customer fully indemnifies Nexperia for any liability, damages or failed product claims resulting from customer design and use of the product for automotive applications beyond Nexperia's standard warranty and Nexperia's product specifications.

11.4 Trademarks

Notice: All referenced brands, product names, service names and trademarks are the property of their respective owners.

12. Contact information

For more information, please visit: <http://www.nexperia.com>



For sales office addresses, please send an email to: salesaddresses@nexperia.com

13. Contents

1	Product profile	1
1.1	General description	1
1.2	Features and benefits	1
1.3	Applications	1
1.4	Quick reference data	1
2	Pinning information	1
3	Ordering information	2
4	Marking	2
5	Limiting values	2
6	Thermal characteristics	4
7	Characteristics	5
8	Package outline	8
9	Soldering	9
10	Revision history	10
11	Legal information	11
11.1	Data sheet status	11
11.2	Definitions	11
11.3	Disclaimers	11
11.4	Trademarks	12
12	Contact information	12

Looking for pricing, stock, or lifecycle information?

Click below to explore more details on WIN SOURCE:

-  [View 2N7002/HAMR on WIN SOURCE](#)
-  [Nexperia USA Inc. Information](#)

Optimize Your Supply Chain with WIN SOURCE Solutions

-  Global Sourcing Solution
-  Obsolete Management
-  Cost Control Management
-  Shortage Management
-  Alternative Solution
-  Excess Inventory Management