



**THE DATASHEET OF
ABM8-25.000MHZ-B2-T**



CERAMIC SMD CRYSTAL



ABM8

3.2 x 2.5 x 0.8mm

ABM8

Moisture Sensitivity Level (MSL) – This product is Hermetically Sealed and not Moisture Sensitive-MSL = N/A: Not Applicable



RoHS
Compliant

FEATURES:

- Seam sealed package assures high reliability
- Tight tolerance and stability available
- Suitable for RoHS reflow

APPLICATIONS:

- High density applications
- Modems, communication and test equipment
- PCMCIA, Wireless applications

STANDARD SPECIFICATIONS:

Parameters	Minimum	Typical	Maximum	Units	Notes
Frequency Range	8.000		125.000*	MHz	Contact Abracon for available F<10MHz
Operation Mode	Fundamental				8MHz - 54MHz
	3rd Overtone (Standard Frequencies: 64, 66, 66.6666, 75, 80, 98.304, 100, 125MHz)				64MHz - 125MHz Please contact Abracon for available frequencies
Operating Temperature	-10		+60	°C	Standard (see options if other than STD)
Storage Temperature	-55		+125	°C	
Frequency Tolerance @+25°C	-50		+50	ppm	Standard (see options if other than STD)
Frequency Stability over the Operating Temperature (ref. to +25°C)	-50		+50	ppm	Standard (see options if other than STD)
Equivalent series resistance (R1)	See table 1 below			Ω	
Shunt capacitance (C0)			3.0	pF	
Load capacitance (CL)		18.0		pF	Standard (See options if other than STD)
Drive Level		10	100	μW	
Aging	-2		+2	ppm	@25°C±3°C First year
Insulation Resistance	500			MΩ	@ 100Vdc ± 15V

TABLE 1- Standard ESR

Frequency (MHz)	ESR(Ω) max	Frequency (MHz)	ESR(Ω) max
8.000-9.999 (Fund)	400	30.000 - 39.999 (Fund)	40
10.000 -11.999 (Fund)	200	40.000 - 54.000 (Fund)	35
12.000 -15.999 (Fund)	120	64.000 - 80.000 (3rd OT)	120
16.000 -19.999 (Fund)	70	98.304 - 125.000 (3rd OT)	80
20.000 - 29.999 (Fund)	50		

OPTIONS AND PART IDENTIFICATION: (Left blank if standard)

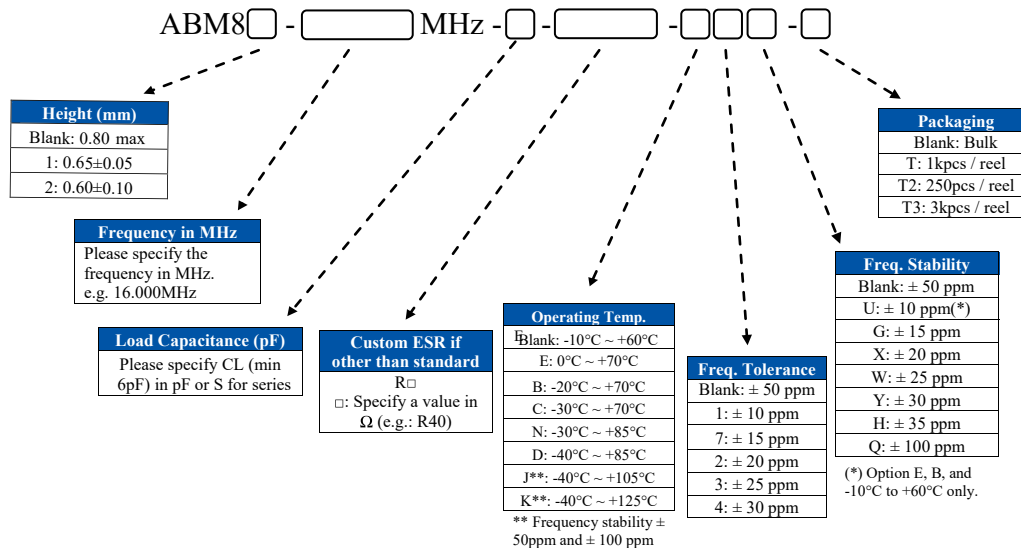

CERAMIC SMD CRYSTAL



3.2 x 2.5 x 0.8mm

ABM8



OUTLINE DRAWING:



Table 2

	Height (mm)
ABM8	0.80 max
ABM81	0.65+/-0.05
ABM82	0.60+/-0.10

Note: Due to material availability, the chamfer could be located on pin #1, 3, or 4. Be advised that the chamfer location has no impact on the electrical performance of the device.

Dimensions: mm

TAPE & REEL:

- Option "-T" : Tape and reel (1,000pcs/reel) : ABM8, ABM82
Tape and reel (3,000pcs/reel) : ABM81
- Option "-T2" : Tape and reel (250pcspcs/reel) : ABM8
- Option "-T3" : Tape and reel (3,000pcs/reel) : ABM8, ABM82 only

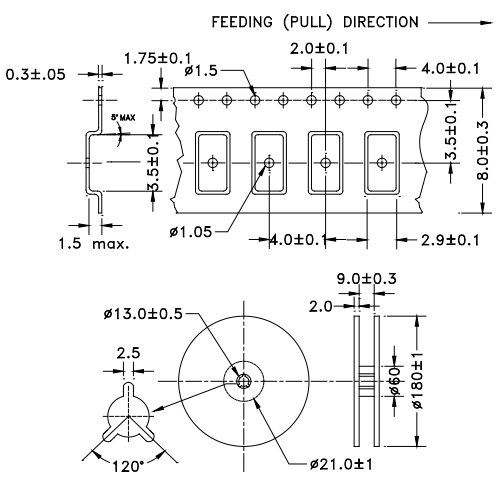

Dimensions: mm

REFLOW PROFILE:



Zone	Description	Temperature	Time
1	Preheat	T _{SMIN} ~ T _{SMAX} 150°C ~ 180°C	60 ~ 120 sec.
2	Reflow	T _L 230°C	30 ~ 40 sec.
3	Peak heat	T _p 260°C ± 5°C	10 sec. MAX

ATTENTION: Abracon LLC's products are COTS – Commercial-Off-The-Shelf products; suitable for Commercial, Industrial and, where designated, Automotive Applications. Abracon's products are not specifically designed for Military, Aviation, Aerospace, Life-dependent Medical applications or any application requiring high reliability where component failure could result in loss of life and/or property. For applications requiring high reliability and/or presenting an extreme operating environment, written consent and authorization from Abracon LLC is required. Please contact Abracon LLC for more information.



5101 Hidden Creek Ln Spicewood TX 78669
 Phone: 512-371-6159 | Fax: 512-351-8858
 For terms and conditions of sales, please visit:
www.abracon.com

REVISED: 07-29-20

ABRACON IS
 ISO9001-2015
 CERTIFIED

Looking for pricing, stock, or lifecycle information?

Click below to explore more details on WIN SOURCE:

 [View ABM8-25.000MHZ-B2-T on WIN SOURCE](#)

 [Abracon LLC Information](#)

Optimize Your Supply Chain with WIN SOURCE Solutions

-  Global Sourcing Solution
-  Obsolete Management
-  Cost Control Management
-  Shortage Management
-  Alternative Solution
-  Excess Inventory Management