



THE DATASHEET OF BS170G



BS170

Small Signal MOSFET 500 mA, 60 Volts N-Channel TO-92 (TO-226)

Features

- This is a Pb-Free Device*

MAXIMUM RATINGS

Rating	Symbol	Value	Unit
Drain-Source Voltage	V_{DS}	60	Vdc
Gate-Source Voltage	V_{GS} V_{GSM}	± 20	Vdc
		± 40	Vpk
Drain Current (Note)	I_D	0.5	Adc
Total Device Dissipation @ $T_A = 25^\circ\text{C}$	P_D	350	mW
Operating and Storage Junction Temperature Range	T_J, T_{stg}	-55 to +150	$^\circ\text{C}$

Stresses exceeding those listed in the Maximum Ratings table may damage the device. If any of these limits are exceeded, device functionality should not be assumed, damage may occur and reliability may be affected.

NOTE: The Power Dissipation of the package may result in a lower continuous drain current.

*For additional information on our Pb-Free strategy and soldering details, please download the ON Semiconductor Soldering and Mounting Techniques Reference Manual, SOLDERRM/D.



ON Semiconductor®

www.onsemi.com

500 mA, 60 Volts
 $R_{DS(on)} = 5.0 \Omega$

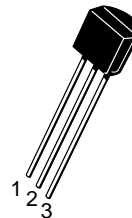
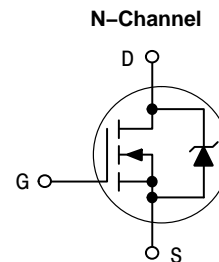

TO-92 (TO-226)
CASE 29
STYLE 30

MARKING DIAGRAM & PIN ASSIGNMENT

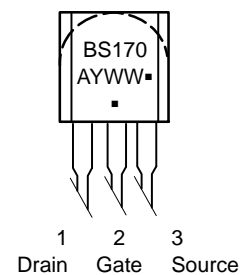

A = Assembly Location
Y = Year
WW = Work Week
▪ = Pb-Free Package

(Note: Microdot may be in either location)

ORDERING INFORMATION

See detailed ordering and shipping information in the package dimensions section on page 2 of this data sheet.

BS170

ELECTRICAL CHARACTERISTICS (T_A = 25°C unless otherwise noted)

Characteristic	Symbol	Min	Typ	Max	Unit
----------------	--------	-----	-----	-----	------

OFF CHARACTERISTICS

Gate Reverse Current (V _{GS} = 15 Vdc, V _{DS} = 0)	I _{GSS}	–	0.01	10	nAdc
Drain–Source Breakdown Voltage (V _{GS} = 0, I _D = 100 μAdc)	V _{(BR)DSS}	60	90	–	Vdc

ON CHARACTERISTICS (Note 1)

Gate Threshold Voltage (V _{DS} = V _{GS} , I _D = 1.0 mAdc)	V _{GS(Th)}	0.8	2.0	3.0	Vdc
Static Drain–Source On Resistance (V _{GS} = 10 Vdc, I _D = 200 mAdc)	r _{DS(on)}	–	1.8	5.0	Ω
Drain Cutoff Current (V _{DS} = 25 Vdc, V _{GS} = 0 Vdc)	I _{D(off)}	–	–	0.5	μA
Forward Transconductance (V _{DS} = 10 Vdc, I _D = 250 mAdc)	g _{fs}	–	200	–	mmhos

SMALL–SIGNAL CHARACTERISTICS

Input Capacitance (V _{DS} = 10 Vdc, V _{GS} = 0, f = 1.0 MHz)	C _{iss}	–	–	60	pF
---	------------------	---	---	----	----

SWITCHING CHARACTERISTICS

Turn–On Time (I _D = 0.2 Adc) See Figure 1	t _{on}	–	4.0	10	ns
Turn–Off Time (I _D = 0.2 Adc) See Figure 1	t _{off}	–	4.0	10	ns

Product parametric performance is indicated in the Electrical Characteristics for the listed test conditions, unless otherwise noted. Product performance may not be indicated by the Electrical Characteristics if operated under different conditions.

1. Pulse Test: Pulse Width ≤ 300 μs, Duty Cycle ≤ 2.0%.

ORDERING INFORMATION

Device	Package	Shipping†
BS170	TO–92 (TO–226) (Pb–Free)	1000 Unit/Tube
BS170RLRAG	TO–92 (TO–226) (Pb–Free)	2000 Tape & Reel

†For information on tape and reel specifications, including part orientation and tape sizes, please refer to our Tape and Reel Packaging Specifications Brochure, BRD8011/D.

RESISTIVE SWITCHING

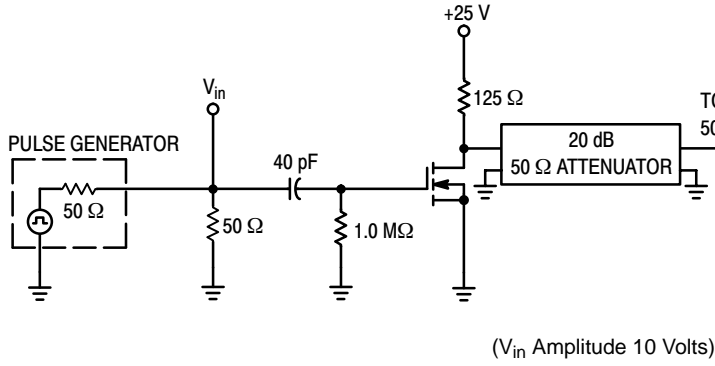

Figure 1. Switching Test Circuit

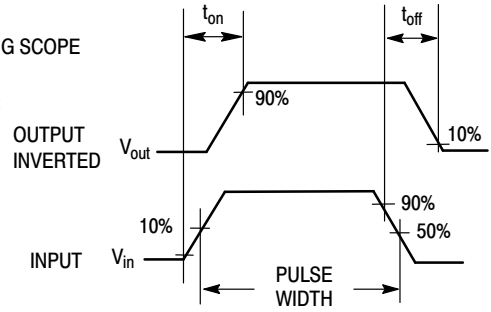

Figure 2. Switching Waveforms

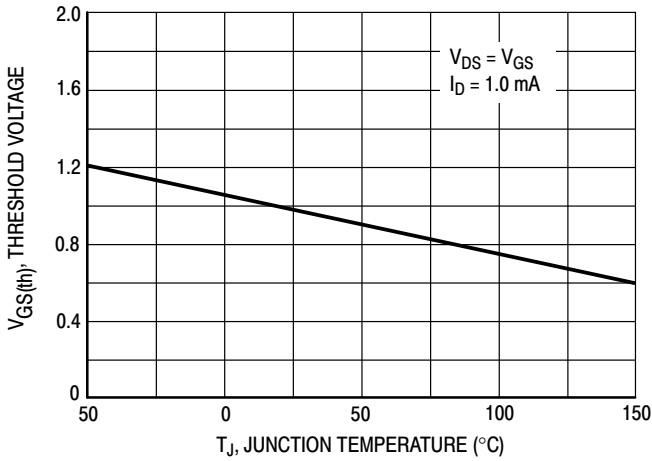

Figure 3. $V_{GS(th)}$ Normalized versus Temperature

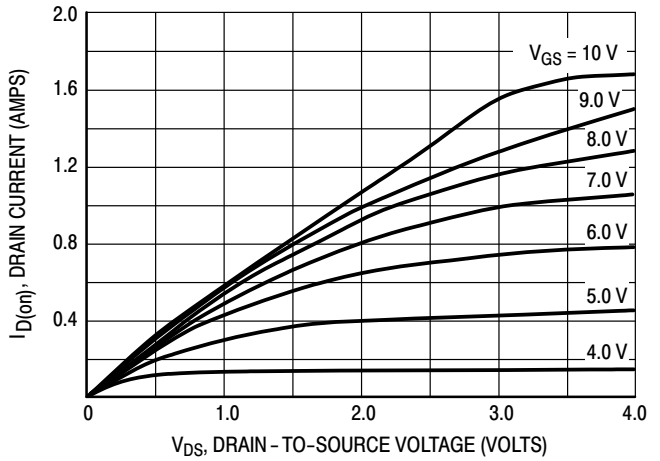

Figure 4. On-Region Characteristics

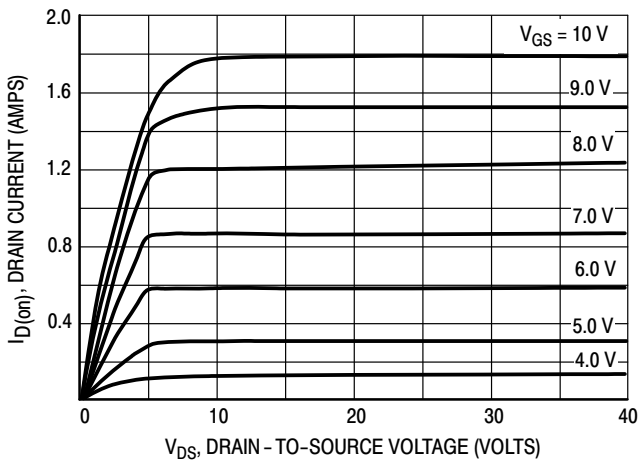

Figure 5. Output Characteristics

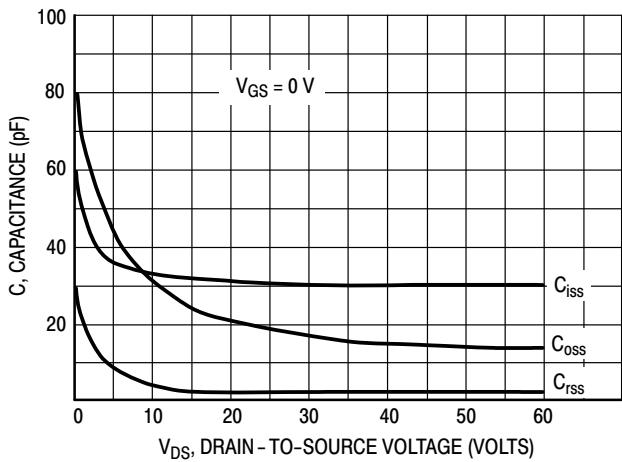
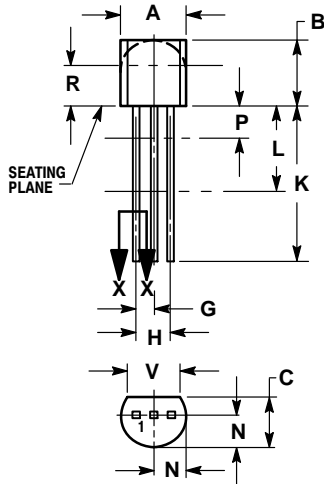

Figure 6. Capacitance versus Drain-To-Source Voltage

BS170

PACKAGE DIMENSIONS

TO-92 (TO-226) CASE 29-11 ISSUE AM



STRAIGHT LEAD
BULK PACK

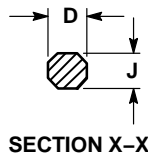

SECTION X-X

NOTES:

1. DIMENSIONING AND TOLERANCING PER ANSI Y14.5M, 1982.
2. CONTROLLING DIMENSION: INCH.
3. CONTOUR OF PACKAGE BEYOND DIMENSION R IS UNCONTROLLED.
4. LEAD DIMENSION IS UNCONTROLLED IN P AND BEYOND DIMENSION K MINIMUM.

DIM	INCHES		MILLIMETERS	
	MIN	MAX	MIN	MAX
A	0.175	0.205	4.45	5.20
B	0.170	0.210	4.32	5.33
C	0.125	0.165	3.18	4.19
D	0.016	0.021	0.407	0.533
G	0.045	0.055	1.15	1.39
H	0.095	0.105	2.42	2.66
J	0.015	0.020	0.39	0.50
K	0.500	---	12.70	---
L	0.250	---	6.35	---
N	0.080	0.105	2.04	2.66
P	---	0.100	---	2.54
R	0.115	---	2.93	---
V	0.135	---	3.43	---

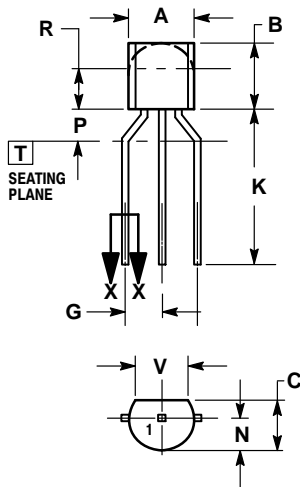

BENT LEAD
TAPE & REEL
AMMO PACK

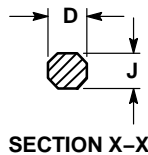

SECTION X-X

NOTES:

1. DIMENSIONING AND TOLERANCING PER ASME Y14.5M, 1994.
2. CONTROLLING DIMENSION: MILLIMETERS.
3. CONTOUR OF PACKAGE BEYOND DIMENSION R IS UNCONTROLLED.
4. LEAD DIMENSION IS UNCONTROLLED IN P AND BEYOND DIMENSION K MINIMUM.

DIM	MILLIMETERS	
	MIN	MAX
A	4.45	5.20
B	4.32	5.33
C	3.18	4.19
D	0.40	0.54
G	2.40	2.80
J	0.39	0.50
K	12.70	---
N	2.04	2.66
P	1.50	4.00
R	2.93	---
V	3.43	---

STYLE 30:

1. DRAIN
2. GATE
3. SOURCE

ON Semiconductor and are trademarks of Semiconductor Components Industries, LLC dba ON Semiconductor or its subsidiaries in the United States and/or other countries. ON Semiconductor owns the rights to a number of patents, trademarks, copyrights, trade secrets, and other intellectual property. A listing of ON Semiconductor's product/patent coverage may be accessed at www.onsemi.com/site/pdf/Patent-Marketing.pdf. ON Semiconductor reserves the right to make changes without further notice to any products herein. ON Semiconductor makes no warranty, representation or guarantee regarding the suitability of its products for any particular purpose, nor does ON Semiconductor assume any liability arising out of the application or use of any product or circuit, and specifically disclaims any and all liability, including without limitation special, consequential or incidental damages. Buyer is responsible for its products and applications using ON Semiconductor products, including compliance with all laws, regulations and safety requirements or standards, regardless of any support or applications information provided by ON Semiconductor. "Typical" parameters which may be provided in ON Semiconductor data sheets and/or specifications can and do vary in different applications and actual performance may vary over time. All operating parameters, including "Typicals" must be validated for each customer application by customer's technical experts. ON Semiconductor does not convey any license under its patent rights nor the rights of others. ON Semiconductor products are not designed, intended, or authorized for use as a critical component in life support systems or any FDA Class 3 medical devices or medical devices with a same or similar classification in a foreign jurisdiction or any devices intended for implantation in the human body. Should Buyer purchase or use ON Semiconductor products for any such unintended or unauthorized application, Buyer shall indemnify and hold ON Semiconductor and its officers, employees, subsidiaries, affiliates, and distributors harmless against all claims, costs, damages, and expenses, and reasonable attorney fees arising out of, directly or indirectly, any claim of personal injury or death associated with such unintended or unauthorized use, even if such claim alleges that ON Semiconductor was negligent regarding the design or manufacture of the part. ON Semiconductor is an Equal Opportunity/Affirmative Action Employer. This literature is subject to all applicable copyright laws and is not for resale in any manner.

PUBLICATION ORDERING INFORMATION

LITERATURE FULFILLMENT:

Literature Distribution Center for ON Semiconductor
19521 E. 32nd Pkwy, Aurora, Colorado 80011 USA
Phone: 303-675-2175 or 800-344-3860 Toll Free USA/Canada
Fax: 303-675-2176 or 800-344-3867 Toll Free USA/Canada
Email: orderlit@onsemi.com

N. American Technical Support: 800-282-9855 Toll Free
USA/Canada
Europe, Middle East and Africa Technical Support:
Phone: 421 33 790 2910
Japan Customer Focus Center
Phone: 81-3-5817-1050



ON Semiconductor Website: www.onsemi.com

Order Literature: <http://www.onsemi.com/orderlit>

For additional information, please contact your local Sales Representative

Looking for pricing, stock, or lifecycle information?

Click below to explore more details on WIN SOURCE:

-  [View BS170G](#) on WIN SOURCE
-  [ON Semiconductor](#) Information

Optimize Your Supply Chain with WIN SOURCE Solutions

-  Global Sourcing Solution
-  Obsolete Management
-  Cost Control Management
-  Shortage Management
-  Alternative Solution
-  Excess Inventory Management