



Industrial Current/Voltage Output Driver with Programmable Ranges

Data Sheet

AD5750/AD5750-1/AD5750-2

FEATURES

Current output ranges: 4 mA to 20 mA, 0 mA to 20 mA, 0 mA to 24 mA, ± 20 mA, and ± 24 mA

$\pm 0.03\%$ full-scale range (FSR) total unadjusted error (TUE)

± 5 ppm/ $^{\circ}$ C typical output drift

Voltage output ranges: 0 V to 5 V, 0 V to 10 V, ± 5 V, and ± 10 V with 20% overrange

$\pm 0.02\%$ FSR TUE

± 3 ppm/ $^{\circ}$ C typical output drift

Flexible serial digital interface

On-chip output fault detection

Packet error checking (PEC)

Asynchronous CLEAR function

Flexible power-up condition to 0 V or tristate

Power supply range

AV_{DD} : +12 V ($\pm 10\%$) to +24 V ($\pm 10\%$)

AV_{SS} : -12 V ($\pm 10\%$) to -24 V ($\pm 10\%$)

Output loop compliance to $AV_{DD} - 2.75$ V

Temperature range: -40 $^{\circ}$ C to +105 $^{\circ}$ C

32-lead, 5 mm \times 5 mm LFCSP package

APPLICATIONS

Process controls

Actuator controls

PLCs

GENERAL DESCRIPTION

The [AD5750/AD5750-1/AD5750-2](#) are single-channel, low cost, precision voltage/current output drivers with hardware- or software-programmable output ranges. The software ranges are configured via an SPI-/MICROWIRE™-compatible serial interface. The [AD5750/AD5750-1/AD5750-2](#) target applications in PLC and industrial process control. The analog input to the [AD5750/AD5750-1/AD5750-2](#) is provided from a low voltage, single-supply digital-to-analog converter (DAC) and is internally conditioned to provide the desired output current/voltage range. Analog input ranges available are 0 V to 2.5 V ([AD5750-1/AD5750-2](#)) or 0 V to 4.096 V ([AD5750](#)).

The output current range is programmable across five current ranges: 4 mA to 20 mA, 0 mA to 20 mA, 0 mA to 24 mA, ± 20 mA, and ± 24 mA. An overrange of 2% is available on the unipolar current ranges.

Voltage output is provided from a separate pin that can be configured to provide 0 V to 5 V, 0 V to 10 V, ± 5 V, or ± 10 V output ranges. An overrange of 20% is available on the voltage ranges.

Analog outputs are short-circuit and open-circuit protected and can drive capacitive loads of 1 μ F and inductive loads of 0.1 H.

The devices are specified to operate with a power supply range from ± 12 V to ± 24 V. Output loop compliance is 0 V to $AV_{DD} - 2.75$ V.

The flexible serial interface is SPI and MICROWIRE compatible and can operate in 3-wire mode to minimize the digital isolation required in isolated applications. The interface also features an optional PEC feature using CRC-8 error checking, useful in industrial environments where data communication corruption can occur.

The devices also include a power-on-reset function, ensuring that the devices power up in a known state (0 V or tristate), and an asynchronous CLEAR pin that sets the outputs to a zero scale/mid-scale voltage output or the low end of the selected current range.

The HW SELECT pin is used to configure the parts for hardware or software mode on power-up.

Table 1. Related Devices

Part Number	Description
AD5422	Single channel, 16-bit, serial input current source and voltage output DAC
AD5751	Industrial I/V output driver, single supply, 55 V maximum supply, programmable ranges
AD5420	Single channel, 16-bit, serial input, 4 mA to 20 mA current source DAC

Rev. F

[Document Feedback](#)

Information furnished by Analog Devices is believed to be accurate and reliable. However, no responsibility is assumed by Analog Devices for its use, nor for any infringements of patents or other rights of third parties that may result from its use. Specifications subject to change without notice. No license is granted by implication or otherwise under any patent or patent rights of Analog Devices. Trademarks and registered trademarks are the property of their respective owners.

One Technology Way, P.O. Box 9106, Norwood, MA 02062-9106, U.S.A.
Tel: 781.329.4700 ©2009–2014 Analog Devices, Inc. All rights reserved.
[Technical Support](#) www.analog.com

TABLE OF CONTENTS

Features	1	OUTEN.....	26
Applications.....	1	Software Control	26
General Description	1	Hardware Control	28
Revision History	2	Transfer Function	28
Functional Block Diagram	3	Detailed Description of Features.....	29
Specifications.....	4	Output Fault Alert—Software Mode	29
Timing Characteristics	8	Output Fault Alert—Hardware Mode.....	29
Absolute Maximum Ratings.....	10	Voltage Output Short-Circuit Protection.....	29
ESD Caution.....	10	Asynchronous Clear (CLEAR)	29
Pin Configuration and Function Descriptions.....	11	External Current Setting Resistor	30
Typical Performance Characteristics	13	Programmable Overrange Modes.....	30
Voltage Output.....	13	Packet Error Checking.....	30
Current Output.....	17	Applications Information	31
Terminology	22	Transient Voltage Protection	31
Theory of Operation	23	Thermal Considerations.....	31
Software Mode	23	Layout Guidelines.....	31
Current Output Architecture.....	25	Galvanically Isolated Interface	32
Driving Inductive Loads.....	25	Microprocessor Interfacing.....	32
Power-On State of AD5750/AD5750-1/AD5750-2.....	25	Outline Dimensions	33
Default Registers at Power-On	26	Ordering Guide	33
Reset Function	26		

REVISION HISTORY

9/14—Rev. E to Rev. F

Changes to Accuracy, Internal R _{SET} Parameter, Table 2.....	6
Changes to Table 4.....	10
Changes to Figure 4.....	11
Changes to Figure 46.....	20
Changes to Asynchronous Clear (CLEAR) Section.....	29
Changes to Thermal Consideration Section.....	31
Updated Outline Dimensions	33
Changes to Ordering Guide	33

6/12—Rev. D to Rev. E

Changes to Figure 3.....	9
Changes to Status Bit Read Operation Section.....	28
Updated Outline Dimensions	33

4/12—Rev. C to Rev. D

Added AD5750-2.....	Universal
Changes to Table 2.....	4
Updated Outline Dimensions	33
Changes to Ordering Guide	33

7/10—Rev. B to Rev. C

Added Leakage Current in Voltage Output Characteristics Parameter (Table 2)	5
Added Leakage Current in Current Output Characteristics Parameter (Table 2)	6

6/10—Rev. A to Rev. B

Changes to Table 1.....	1
Changes to Table 2, Power Requirements	7

8/09—Rev. 0 to Rev. A

Added AD5750-1.....	Universal
Changes to Features and General Description Sections	1
Changes to Table 2.....	4
Changes to Theory of Operation Section and Figure 51	23
Change to Figure 52 and Table 6 Title.....	24
Changes to Current Output Architecture Section and Power-On State of AD5750/AD5750-1	25
Changes to Transfer Function Section	28
Changes to Programmable Overrange Modes Section	30
Changes to Ordering Guide	33

7/09—Revision 0: Initial Version

FUNCTIONAL BLOCK DIAGRAM

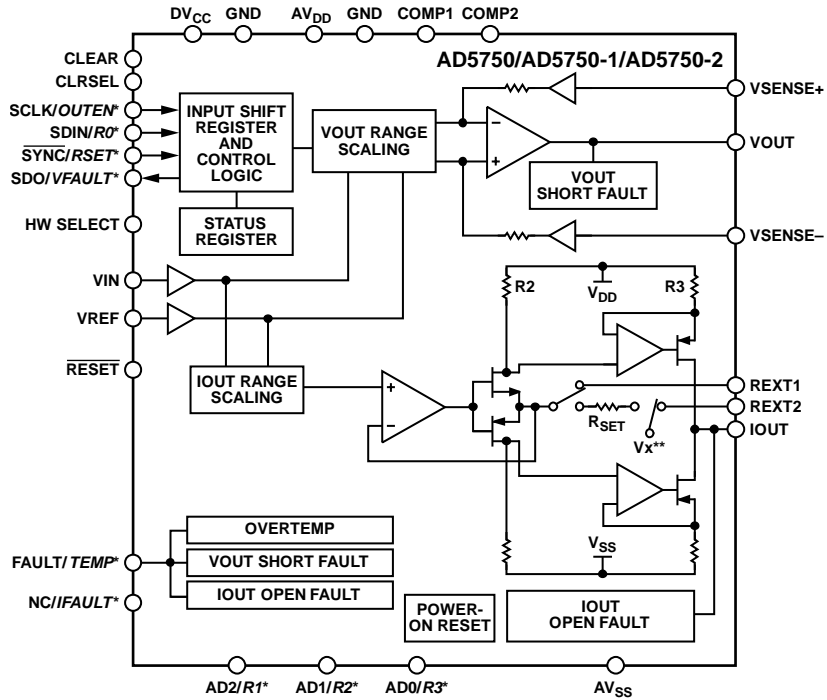

* DENOTES SHARED PIN. SOFTWARE MODE DENOTED BY REGULAR TEXT, HARDWARE MODE DENOTED BY *ITALIC* TEXT. FOR EXAMPLE, FOR FAULT/ *TEMP* PIN, IN SOFTWARE MODE, THIS PIN TAKES ON FAULT FUNCTION. IN HARDWARE MODE, THIS PIN TAKES ON *TEMP* FUNCTION.
 ** V_x IS AN INTERNAL BIAS VOLTAGE (CAN BE GROUND OR OTHER VOLTAGE) THAT IS USED TO GENERATE THE INTERNAL SENSE CURRENTS NEEDED FOR THE CURRENT OUTPUTS.

07298-001

Figure 1.

SPECIFICATIONS

$AV_{DD}/AV_{SS} = \pm 12\text{ V} (\pm 10\%)$ to $\pm 24\text{ V} (\pm 10\%)$, $DV_{CC} = 2.7\text{ V}$ to 5.5 V , $GND = 0\text{ V}$. I_{OUT} : $R_{LOAD} = 300\ \Omega$. All specifications T_{MIN} to T_{MAX} , unless otherwise noted.

Table 2.

Parameter ¹	Min	Typ	Max	Unit	Test Conditions/Comments
INPUT VOLTAGE RANGE					Output unloaded
		0 to 4.096		V	AD5750
		0 to 2.5		V	AD5750-1/AD5750-2
Input Leakage Current	-1		+1	μA	
REFERENCE INPUT					
Reference Input Voltage		4.096		V	AD5750; external reference must to be exactly as stated; otherwise, accuracy errors show up as error in output
		2.5		V	AD5750-2; external reference needs to be exactly as stated; otherwise, accuracy errors show up as error in output
		1.25		V	AD5750-1; external reference needs to be exactly as stated; otherwise, accuracy errors show up as error in output
Input Leakage Current	-1		+1	μA	
VOLTAGE OUTPUT					
Output Voltage Ranges	0		5	V	
	0		10	V	AV_{DD} needs to have minimum 1.3 V headroom or $>11.3\text{ V}$
	-5		+5	V	
	-10		+10	V	AV_{DD}/AV_{SS} needs to have minimum 1.3 V headroom or $>\pm 11.3\text{ V}$
Output Voltage Overranges	0		6	V	Programmable overranges; see the Detailed Description of Features section
	0		12	V	
	-6		+6	V	
	-12		+12	V	
	-2.5		+2.5	V	
Accuracy					
Total Unadjusted Error (TUE)					
B Version ²	-0.1		+0.1	% FSR	
	-0.05	± 0.02	+0.05	% FSR	$T_A = 25^\circ\text{C}$
A Version ²	-0.3		+0.3	% FSR	
	-0.1	± 0.05	+0.1	% FSR	$T_A = 25^\circ\text{C}$
Relative Accuracy (INL)	-0.02	± 0.005	+0.02	% FSR	
Bipolar Zero Error (Offset at Midscale)	-10		+10	mV	$\pm 10\text{ V}$ range
	-8	± 0.5	+8	mV	$T_A = 25^\circ\text{C}$, $\pm 10\text{ V}$ range
	-5		+5	mV	$\pm 5\text{ V}$ range
	-4	± 0.3	+4	mV	$T_A = 25^\circ\text{C}$, $\pm 5\text{ V}$ range
Bipolar Zero Error Temperature Coefficient ³		± 1.5		ppm FSR/ $^\circ\text{C}$	All bipolar ranges
Zero-Scale Error	-10		+10	mV	$\pm 10\text{ V}$ range
	-8	± 0.5	+8	mV	$T_A = 25^\circ\text{C}$, $\pm 10\text{ V}$ range
	-5		+5	mV	$\pm 5\text{ V}$ range
	-4	± 0.3	+4	mV	$T_A = 25^\circ\text{C}$, $\pm 5\text{ V}$ range

Parameter ¹	Min	Typ	Max	Unit	Test Conditions/Comments
Zero-Scale Error Temperature Coefficient ³		±1		ppm FSR/°C	All bipolar ranges
Zero-Scale/Offset Error	-5		+5	mV	0 V to 10 V range
	-4	±0.5	+4	mV	T _A = 25°C, 0 V to 10 V range
	-3		+3	mV	0 V to 5 V range
	-2.2	±0.3	+2.2	mV	T _A = 25°C, 0 V to 5 V range
Offset Error Temperature Coefficient ³		±2		ppm FSR/°C	All unipolar ranges
Gain Error	-0.05		+0.05	% FSR	All bipolar/unipolar ranges, AD5750 and AD5750-1
	-0.07		+0.07	% FSR	AD5750-2
	-0.04	±0.015	+0.04	% FSR	T _A = 25°C, AD5750, AD5750-1, and AD5750-2
Gain Error Temperature Coefficient ³		±0.5		ppm FSR/°C	
Full-Scale Error	-0.05		+0.05	% FSR	All bipolar/unipolar ranges, AD5750 and AD5750-1
	-0.04	±0.015	+0.04	% FSR	T _A = 25°C, AD5750 and AD5750-1
	-0.07		+0.07	% FSR	AD5750-2
Full-Scale Error Temperature Coefficient ³		±1.5		ppm FSR/°C	
VOLTAGE OUTPUT CHARACTERISTICS³					
Headroom			1.3	V	Output unloaded
Short-Circuit Current		15		mA	
Load	1			kΩ	
Capacitive Load Stability					T _A = 25°C
R _{LOAD} = ∞			1	nF	
R _{LOAD} = 2 kΩ			1	nF	
R _{LOAD} = ∞			2	μF	External compensation capacitor required; see the Driving Inductive Loads section
DC Output Impedance		0.12		Ω	
Leakage Current	-110		+110	nA	Output disabled; leakage to ground
0 V to 5 V Range, ¼ to ¾ Step		7		μs	Specified with 2 kΩ 220 pF, ±0.05%
0 V to 5 V Range, 40 mV Input Step		4.5		μs	Specified with 2 kΩ 220 pF, ±0.05%
Slew Rate		2		V/μs	Specified with 2 kΩ 220 pF
Output Noise		2.5		μV rms	0.1 Hz to 10 Hz bandwidth
		45.5		μV rms	100 kHz bandwidth
Output Noise Spectral Density		165		nV/√Hz	Measured at 10 kHz; specified with 2 kΩ 220 pF
AC PSRR		-65		dB	200 mV, 50 Hz/60 Hz sine wave superimposed on power supply voltage
DC PSRR		10		μV/V	Outputs unloaded
CURRENT OUTPUT					
Output Current Ranges	0		24	mA	
	0		20	mA	
	4		20	mA	
	-20		+20	mA	
	-24		+24	mA	
Output Current Overranges	0		24.5	mA	See the Detailed Description of Features section
	0		20.4	mA	See the Detailed Description of Features section
	4		20.4	mA	See the Detailed Description of Features section

Parameter ¹	Min	Typ	Max	Unit	Test Conditions/Comments
ACCURACY, INTERNAL R _{SET}					
Total Unadjusted Error (TUE)					
B Version ²	-0.2		+0.2	% FSR	
A Version ²	-0.1	±0.03	+0.1	% FSR	T _A = 25°C
Relative Accuracy (INL)	-0.5	±0.15	+0.5	% FSR	T _A = 25°C
Offset Error	-0.3	±0.01	+0.3	% FSR	Unipolar ranges
Offset Error	-0.02	±0.015	+0.02	% FSR	Bipolar ranges
Offset Error	-0.03	±0.015	+0.03	% FSR	4 mA to 20 mA, 0 mA to 20 mA, 0 mA to 24 mA ranges
Offset Error	-16		+16	µA	T _A = 25°C
Offset Error	-10	+5	+10	µA	±20 mA, ±24 mA ranges
Offset Error	-50		+50	µA	T _A = 25°C
Offset Error	-26	+8	+26	µA	±20 mA, ±24 mA ranges
Offset Error		±3		ppm FSR/°C	T _A = 25°C
Offset Error				ppm FSR/°C	All ranges
Bipolar Zero Error	-35		+35	µA	±20 mA, ±24 mA ranges
Bipolar Zero Error	-24	+15	+24	µA	T _A = 25°C
Bipolar Zero Error		±0.5		ppm FSR/°C	All ranges
Bipolar Zero Error				ppm FSR/°C	All ranges
Gain Error	-0.2		+0.2	% FSR	4 mA to 20 mA, 0 mA to 20 mA, 0 mA to 24 mA ranges
Gain Error	-0.25		+0.25	% FSR	±20 mA, ±24 mA ranges
Gain Error	-0.03	±0.006	+0.03	% FSR	T _A = 25°C
Gain Error		±8		ppm FSR/°C	All ranges
Gain Error				ppm FSR/°C	All ranges
Gain Error	-0.2		+0.2	% FSR	All ranges
Gain Error	-0.125	±0.02	+0.125	% FSR	T _A = 25°C
Gain Error		±4		ppm FSR/°C	All ranges
ACCURACY, EXTERNAL R _{SET}					
Total Unadjusted Error (TUE)					
B Version ²	-0.1		+0.1	% FSR	
A Version ²	-0.08	±0.03	+0.08	% FSR	T _A = 25°
Relative Accuracy (INL)	-0.3	±0.02	+0.3	% FSR	T _A = 25°C
Offset Error	-0.1	±0.01	+0.1	% FSR	4 mA to 20 mA, 0 mA to 20 mA, 0 mA to 24 mA ranges
Offset Error	-0.02	±0.01	+0.02	% FSR	±20 mA, ±24 mA ranges
Offset Error	-0.03	±0.015	+0.03	% FSR	4 mA to 20 mA, 0 mA to 20 mA, 0 mA to 24 mA ranges
Offset Error	-14		+14	µA	T _A = 25°C
Offset Error	-11	+5	+11	µA	±20 mA, ±24 mA ranges
Offset Error	-20		+20	µA	T _A = 25°C
Offset Error		+8	+15	µA	±20 mA, ±24 mA ranges
Offset Error		±2		ppm FSR/°C	T _A = 25°C
Offset Error				ppm FSR/°C	All ranges
Bipolar Zero Error	-32		+32	µA	All ranges
Bipolar Zero Error	-22	+12	+22	µA	T _A = 25°C
Bipolar Zero Error		±0.5		ppm FSR/°C	All ranges
Bipolar Zero Error				ppm FSR/°C	All ranges
Gain Error	-0.08		+0.08	% FSR	All ranges
Gain Error	-0.07	±0.02	+0.07	% FSR	T _A = 25°C
Gain Error		±1		ppm FSR/°C	All ranges
Gain Error				ppm FSR/°C	All ranges
Gain Error	-0.1		+0.1	% FSR	All ranges
Gain Error	-0.07	±0.02	+0.07	% FSR	T _A = 25°C
Gain Error		±2		ppm FSR/°C	All ranges

Parameter ¹	Min	Typ	Max	Unit	Test Conditions/Comments
CURRENT OUTPUT CHARACTERISTICS³					
Current Loop Compliance Voltage Resistive Load	0		$AV_{DD} - 2.75$	V	Chosen such that compliance is not exceeded
Inductive Load	See test conditions/comments column				
Settling Time 4 mA to 20 mA, Full-Scale Step		8.5		μs	250 Ω load
4 mA to 20 mA, 120 μA Step		1.2		μs	250 Ω load
DC PSRR			1	$\mu\text{A/V}$	
Output Impedance		130		M Ω	
Leakage Current	-12		+12	nA	Output disabled; leakage to ground
VOUT/VSENSE- Error	0.9994		1.0006	Gain	Error in VOUT voltage due to changes in VSENSE-; specified as gain, for example, if VSENSE- moves by 1 V, VOUT moves by 0.9994 V
DIGITAL INPUT					
Input High Voltage, V_{IH}	2			V	JEDEC compliant
Input Low Voltage, V_{IL}			0.8	V	
Input Current	-1		+1	μA	Per pin
Pin Capacitance		5		pF	Per pin
DIGITAL OUTPUTS³					
FAULT, IFAULT, TEMP, VFAULT Output Low Voltage, V_{OL}		0.6	0.4	V	10 k Ω pull-up resistor to DV_{CC}
Output High Voltage, V_{OH}	3.6			V	At 2.5 mA
SDO Output Low Voltage, V_{OL}	0.5	0.5		V	10 k Ω pull-up resistor to DV_{CC}
Output High Voltage, V_{OH}	$DV_{CC} - 0.5$	$DV_{CC} - 0.5$		V	Sinking 200 μA
High Impedance Output Capacitance		3		pF	Sourcing 200 μA
High Impedance Leakage Current	-1		+1	μA	
POWER REQUIREMENTS					
AV_{DD}	12		24	V	$\pm 10\%$
AV_{SS}	-12		-24	V	$\pm 10\%$
DV_{CC} Input Voltage	2.7		5.5	V	
AI_{DD}		4.4	5.6	mA	Output unloaded, output disabled, R3, R2, R1, R0 = 0, 1, 0, 1; RSET = 0
		5.2	6.2	mA	Current output enabled
		5.2	6.2	mA	Voltage output enabled
AI_{SS}		2.0	2.5	mA	Output unloaded, output disabled, R3, R2, R1, R0 = 0, 1, 0, 1; RSET = 0, AD5750 and AD5750-1
		2.0	3.5	mA	AD5750-2
		2.5	3	mA	Current output enabled
		2.5	3	mA	Voltage output enabled
DI_{CC}		0.3	1	mA	$V_{IH} = DV_{CC}$, $V_{IL} = \text{GND}$
Power Dissipation		108		mW	$AV_{DD}/AV_{SS} = \pm 24\text{ V}$, outputs unloaded

¹ Temperature range: -40°C to +105°C; typical at +25°C.

² Specification includes gain and offset errors over temperature and drift after 1000 hours, $T_A = 125^\circ\text{C}$.

³ Guaranteed by characterization, but not production tested.

TIMING CHARACTERISTICS

$AV_{DD}/AV_{SS} = \pm 12\text{ V} (\pm 10\%)$ to $\pm 24\text{ V} (\pm 10\%)$, $DV_{CC} = 2.7\text{ V}$ to 5.5 V , $GND = 0\text{ V}$. V_{OUT} : $R_{LOAD} = 2\text{ k}\Omega$, $C_L = 200\text{ pF}$, I_{OUT} : $R_{LOAD} = 300\ \Omega$. All specifications T_{MIN} to T_{MAX} , unless otherwise noted.

Table 3.

Parameter ^{1, 2}	Limit at T_{MIN} , T_{MAX}	Unit	Description
t_1	20	ns min	SCLK cycle time
t_2	8	ns min	SCLK high time
t_3	8	ns min	SCLK low time
t_4	5	ns min	\overline{SYNC} falling edge to SCLK falling edge setup time
t_5	10	ns min	16 th SCLK falling edge to \overline{SYNC} rising edge (on 24 th SCLK falling edge if using PEC)
t_6	5	ns min	Minimum \overline{SYNC} high time (write mode)
t_7	5	ns min	Data setup time
t_8	5	ns min	Data hold time
t_9, t_{10}	1.5	μs max	CLEAR pulse low/high activation time
t_{11}	5	ns min	Minimum \overline{SYNC} high time (read mode)
t_{12}	40	ns max	SCLK rising edge to SDO valid ($SDO\ C_L = 15\text{ pF}$)
t_{13}	10	ns min	\overline{RESET} pulse low time

¹ Guaranteed by characterization, but not production tested.

² All input signals are specified with $t_R = t_F = 5\text{ ns}$ (10% to 90% of DV_{CC}) and timed from a voltage level of 1.2 V.

Timing Diagrams

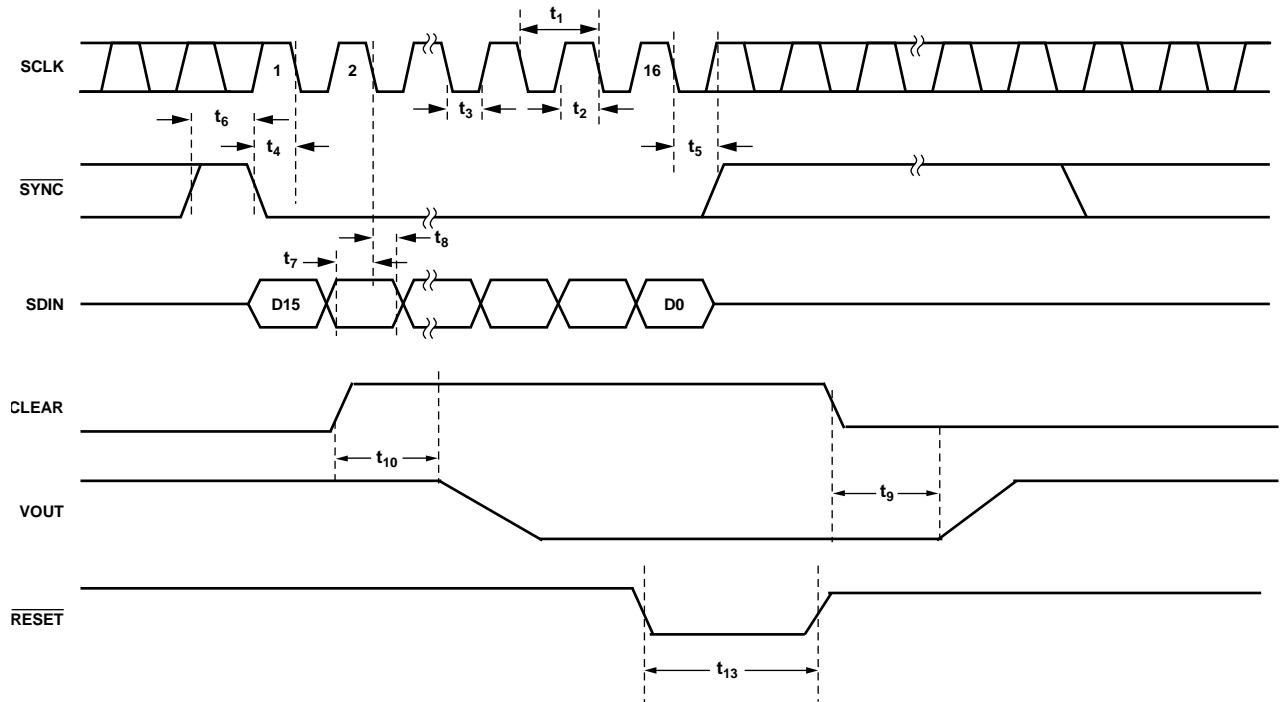

Figure 2. Write Mode Timing Diagram

07288-003

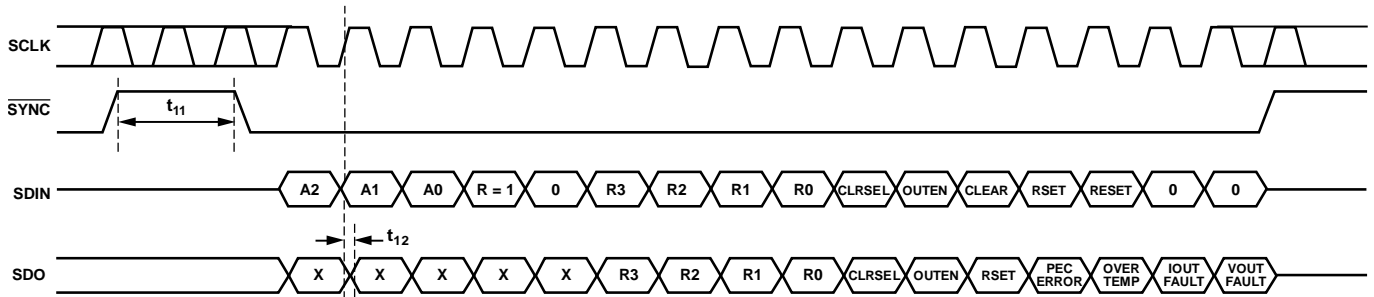

Figure 3. Readback Mode Timing Diagram

07288-004

ABSOLUTE MAXIMUM RATINGS

$T_A = 25^\circ\text{C}$, unless otherwise noted. Transient currents of up to 100 mA do not cause SCR latch-up.

Table 4.

Parameter	Rating
AV_{DD} to GND	-0.3 V to +30 V
AV_{SS} to GND	+0.3 V to -28 V
AV_{DD} to AV_{SS}	-0.3 V to +58 V
DV_{CC} to GND	-0.3 V to +7 V
VSENSE+ to GND	AV_{SS} to AV_{DD}
VSENSE- to GND	± 5.0 V
Digital Inputs to GND	-0.3 V to $DV_{CC} + 0.3$ V or +7 V (whichever is less)
Digital Outputs to GND	-0.3 V to $DV_{CC} + 0.3$ V or +7 V (whichever is less)
VREF to GND	-0.3 V to +7 V
VIN to GND	-0.3 V to +7 V
VOUT, IOOUT to GND	AV_{SS} to AV_{DD}
Operating Temperature Range, Industrial	-40°C to +105°C
Storage Temperature Range	-65°C to +150°C
Junction Temperature (T_J max)	125°C
32-Lead LFCSP Package	
θ_{JA} Thermal Impedance ¹	42°C/W
Lead Temperature	JEDEC industry standard
Soldering	J-STD-020
ESD (Human Body Model)	3 kV

¹ Simulated data based on a JEDEC 2S2P board with thermal vias.

Stresses above those listed under Absolute Maximum Ratings may cause permanent damage to the device. This is a stress rating only; functional operation of the device at these or any other conditions above those indicated in the operational section of this specification is not implied. Exposure to absolute maximum rating conditions for extended periods may affect device reliability.

ESD CAUTION



ESD (electrostatic discharge) sensitive device. Charged devices and circuit boards can discharge without detection. Although this product features patented or proprietary protection circuitry, damage may occur on devices subjected to high energy ESD. Therefore, proper ESD precautions should be taken to avoid performance degradation or loss of functionality.

PIN CONFIGURATION AND FUNCTION DESCRIPTIONS

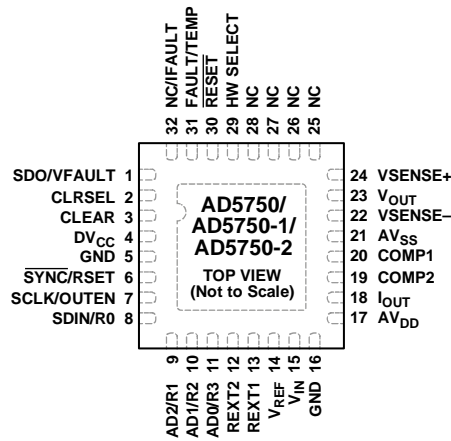

NOTES
 1. NC = NO CONNECT.
 2. THE EXPOSED PADDLE IS TIED TO AVSS.

07268F-005

Figure 4. Pin Configuration

Table 5. Pin Function Descriptions

Pin No.	Mnemonic	Description
1	SDO/VFAULT	Serial Data Output (SDO). In software mode, this pin is used to clock data from the input shift register in readback mode. Data is clocked out on the rising edge of SCLK and is valid on the falling edge of SCLK. This pin is a CMOS output. Short-Circuit Fault Alert (VFAULT). In hardware mode, this pin acts as a short-circuit fault alert pin and is asserted low when a short-circuit error is detected. This pin is an open-drain output and must be connected to a pull-up resistor.
2	CLRSEL	In hardware or software mode, this pin selects the clear value, either zero-scale or midscale code. In software mode, this pin is implemented as a logic OR with the internal CLRSEL bit.
3	CLEAR	Active High Input. Asserting this pin sets the output current/voltage to zero-scale code or midscale code of the range selected (user selectable). CLEAR is a logic OR with the internal clear bit. In software mode, during power-up, the CLEAR pin level determines the power-on condition of the voltage channel, which can be active 0 V or tristate. See the Asynchronous Clear (CLEAR) section for more details.
4	DV _{CC}	Digital Power Supply.
5	GND	Ground Connection.
6	SYNC/RSET	Positive Edge Sensitive Latch (SYNC). In software mode, a rising edge parallel loads the input shift register data into the AD5750/AD5750-1/AD5750-2, also updating the output. Resistor Select (RSET). In hardware mode, this pin selects whether the internal or the external current sense resistor is used. If RSET = 0, the external sense resistor is chosen, and if RSET = 1, the internal sense resistor is chosen.
7	SCLK/OUTEN	Serial Clock Input (SCLK). In software mode, data is clocked into the input shift register on the falling edge of SCLK. This pin operates at clock speeds up to 50 MHz. Output Enable (OUTEN). In hardware mode, this pin acts as an output enable pin.
8	SDIN/R0	Serial Data Input (SDIN). In software mode, data must be valid on the falling edge of SCLK. Range Decode Bit (R0). In hardware mode, this pin, in conjunction with R1, R2, and R3, selects the output current/voltage range setting on the part.
9	AD2/R1	Device Addressing Bit (AD2). In software mode, this pin, in conjunction with AD1 and AD0, allows up to eight devices to be addressed on one bus. Range Decode Bit (R1). In hardware mode, this pin, in conjunction with R0, R2, and R3, selects the output current/voltage range setting on the part.
10	AD1/R2	Device Addressing Bit (AD1). In software mode, this pin, in conjunction with AD2 and AD0, allows up to eight devices to be addressed on one bus. Range Decode Bit (R2). In hardware mode, this pin, in conjunction with R0, R1, and R3, selects the output current/voltage range setting on the part.

Pin No.	Mnemonic	Description
11	AD0/R3	Device Addressing Bit (AD0). In software mode, this pin, in conjunction with AD1 and AD2, allows up to eight devices to be addressed on one bus. Range Decode Bit (R3). In hardware mode, this pin, in conjunction with R0, R1, and R2, selects the output current/voltage range setting on the part.
12, 13	REXT2, REXT1	A 15 k Ω external current setting resistor can be connected between the REXT1 and REXT2 pins to improve the IOUT temperature drift performance.
14	VREF	Buffered Reference Input.
15	VIN	Buffered Analog Input (0 V to 4.096 V).
16	GND	Ground Connection.
17	AV _{DD}	Positive Analog Supply.
18	IOUT	Current Output.
19, 20	COMP2, COMP1	Optional Compensation Capacitor Connections for the Voltage Output Buffer. These pins are used to drive higher capacitive loads on the output. They also reduce overshoot on the output. Care should be taken when choosing the value of the capacitor connected between the COMP1 and COMP2 pins because it has a direct influence on the settling time of the output. See the Driving Large Capacitive Loads section for further details.
21	AV _{SS}	Negative Analog Supply.
22	VSENSE ⁻	Sense Connection for the Negative Voltage Output Load Connection. This pin must stay within ± 3.0 V of ground for correct operation.
23	VOUT	Buffered Analog Output Voltage.
24	VSENSE ⁺	Sense Connection for the Positive Voltage Output Load Connection.
25, 26, 27, 28	NC	No Connect. Can be tied to GND.
29	HW SELECT	This pin is used to configure the part to hardware or software mode. HW SELECT = 0 selects software control, and HW SELECT = 1 selects hardware control.
30	RESET	Resets the part to its power-on state.
31	FAULT/TEMP	Fault Alert (FAULT). In software mode, this pin acts as a general fault alert pin. It is asserted low when an open-circuit error, short-circuit error, overtemperature error, or PEC interface error is detected. This pin is an open-drain output and must be connected to a pull-up resistor. Overtemperature Fault (TEMP). In hardware mode, this pin acts as an overtemperature fault pin. It is asserted low when an overtemperature error is detected. This pin is an open-drain output and must be connected to a pull-up resistor.
32	NC/IFault	No Connect (NC). In software mode, this pin is a no connect. Instead, tie this pin to GND. Open-Circuit Fault Alert (IFault). In hardware mode, this pin acts as an open-circuit fault alert pin. It is asserted low when an open-circuit error is detected. This pin is an open-drain output and must be connected to a pull-up resistor.
	EPAD	The exposed paddle is tied to AV _{SS} .

TYPICAL PERFORMANCE CHARACTERISTICS

VOLTAGE OUTPUT

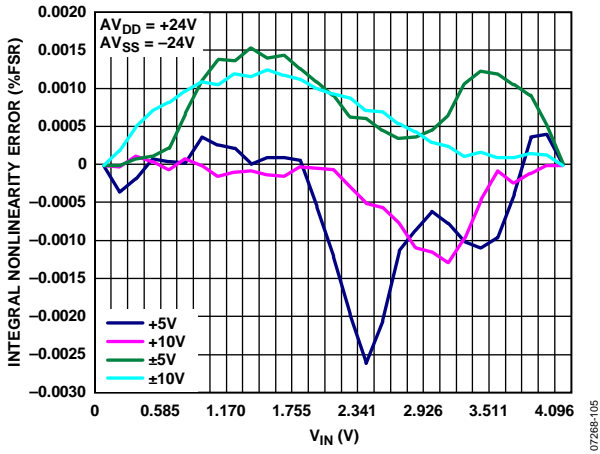

Figure 5. Integral Nonlinearity Error vs. V_{IN}

07268-105

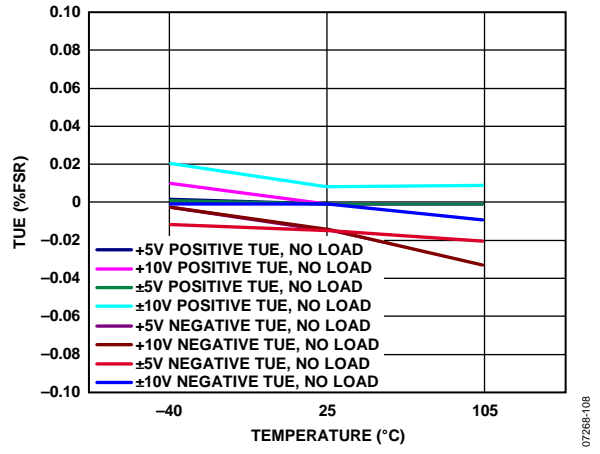

Figure 8. Total Unadjusted Error (TUE) vs. Temperature

07268-108

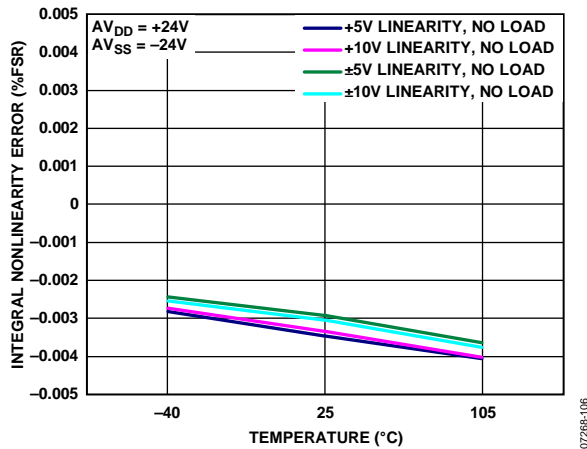

Figure 6. Integral Nonlinearity Error vs. Temperature

07268-106

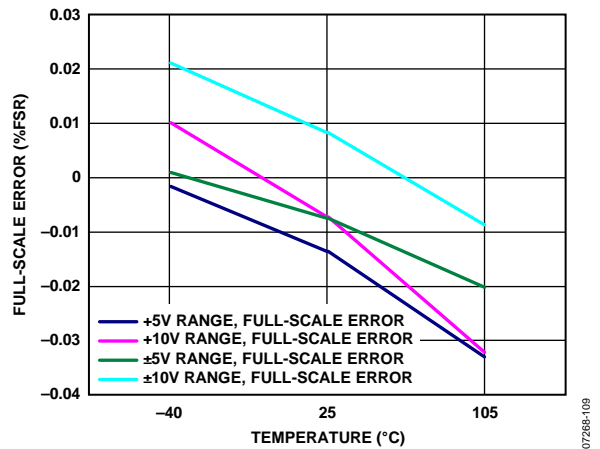

Figure 9. Full-Scale Error vs. Temperature

07268-109

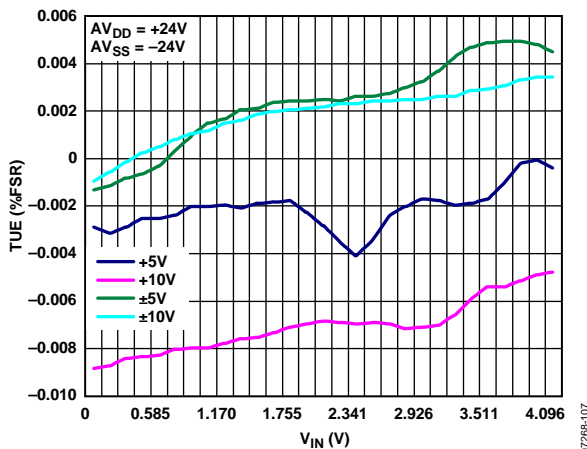

Figure 7. Total Unadjusted Error (TUE) vs. V_{IN}

07268-107

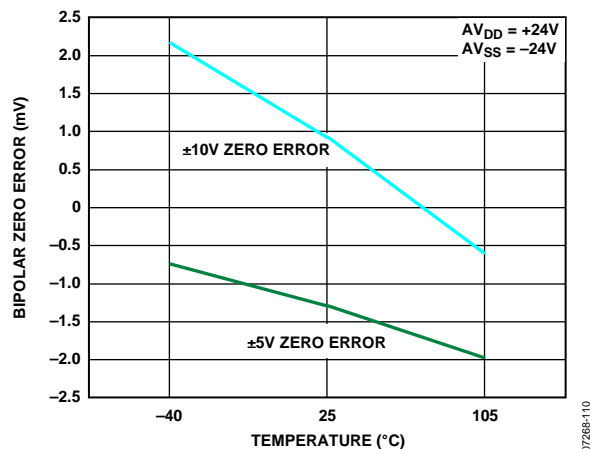

Figure 10. Bipolar Zero Error vs. Temperature

07268-110

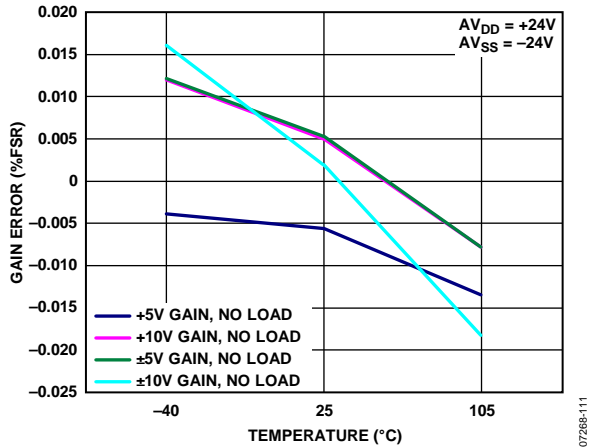

Figure 11. Gain Error vs. Temperature

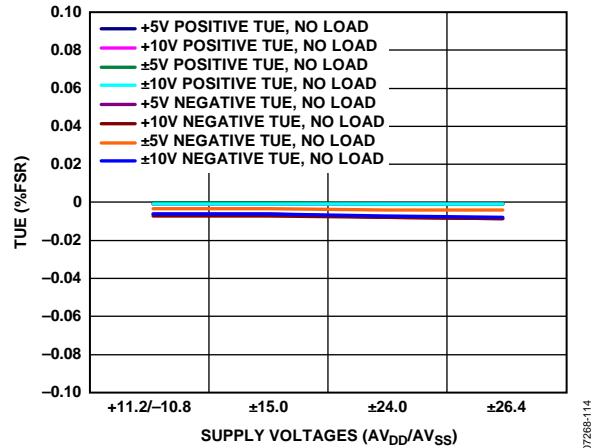

Figure 14. Total Unadjusted Error (TUE) vs. Supply Voltages

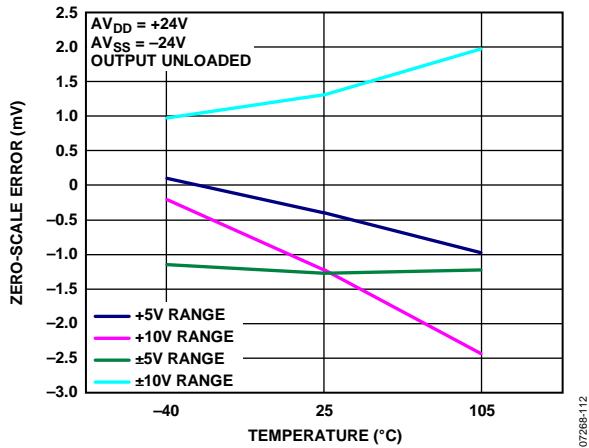

Figure 12. Zero-Scale Error (Offset Error) vs. Temperature

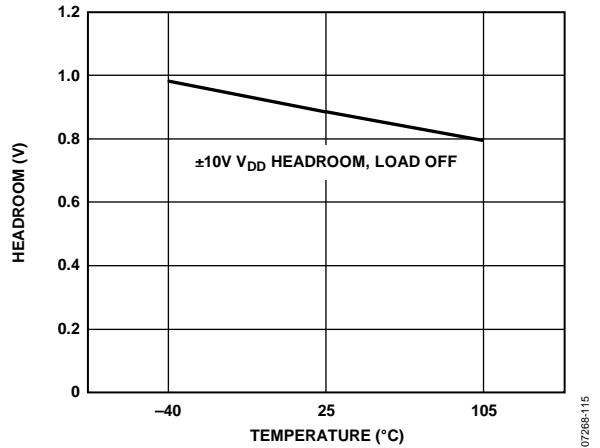

Figure 15. V_{DD} Headroom, $\pm 10V$ Range, Output Set to 10V, Load Off

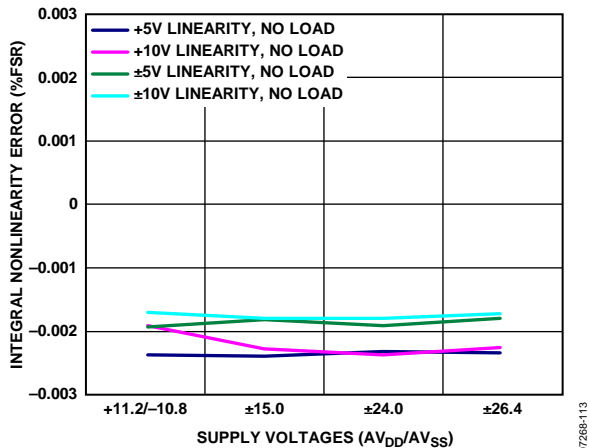

Figure 13. Integral Nonlinearity Error vs. Supply Voltage

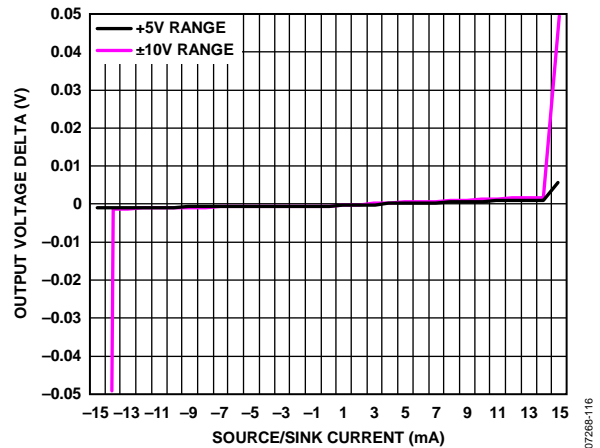

Figure 16. Source and Sink Capability of Output Amplifier

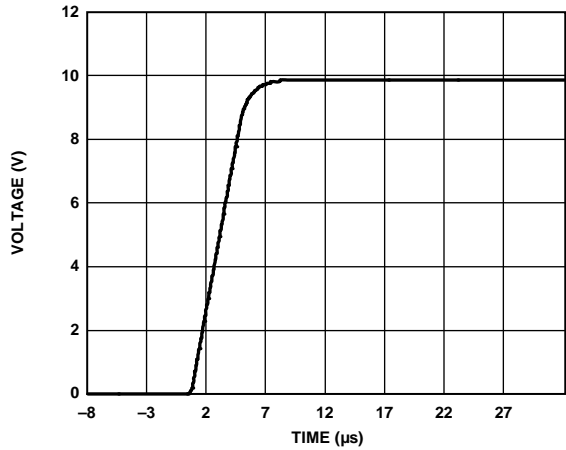

Figure 17. Full-Scale Positive Step

07268-117

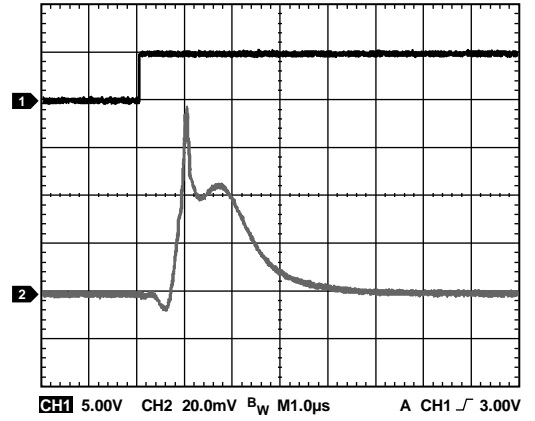

Figure 20. V_{OUT} Enable Glitch, Load = $2\text{ k}\Omega \parallel 1\text{ nF}$

07268-120

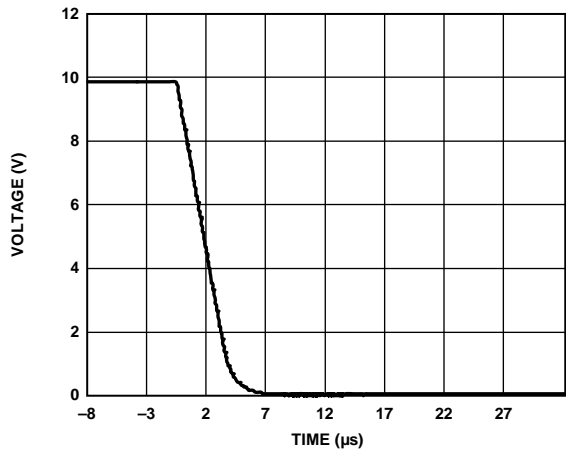

Figure 18. Full-Scale Negative Step

07268-118

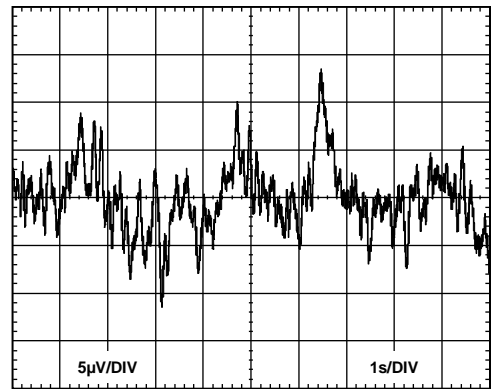

Figure 21. Peak-to-Peak Noise (0.1 Hz to 10 Hz Bandwidth)

07268-121

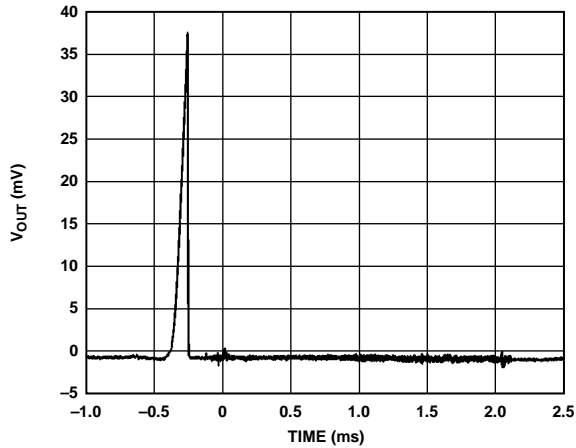

Figure 19. V_{OUT} vs. Time on Power-Up, Load = $2\text{ k}\Omega \parallel 200\text{ pF}$

07268-119

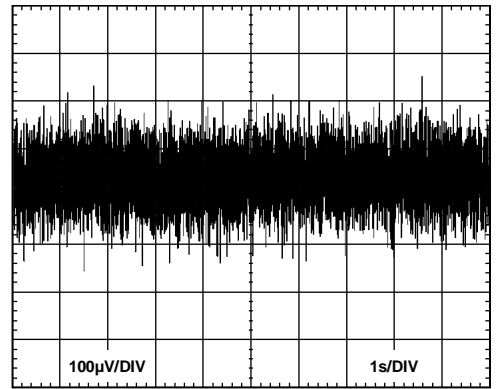

Figure 22. Peak-to-Peak Noise (100 kHz Bandwidth)

07268-122

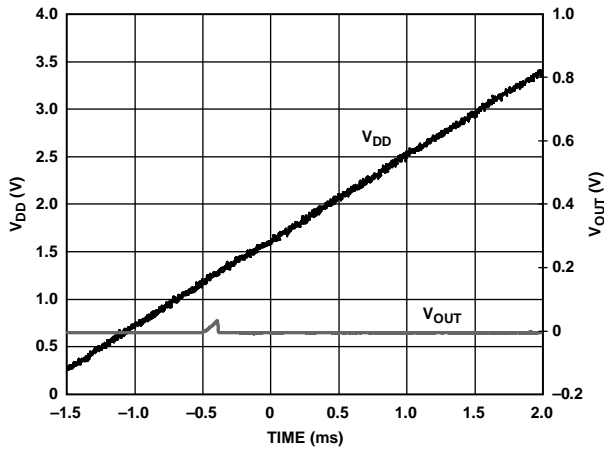

Figure 23. V_{DD} and V_{OUT} vs. Time on Power-Up

07268-123

CURRENT OUTPUT

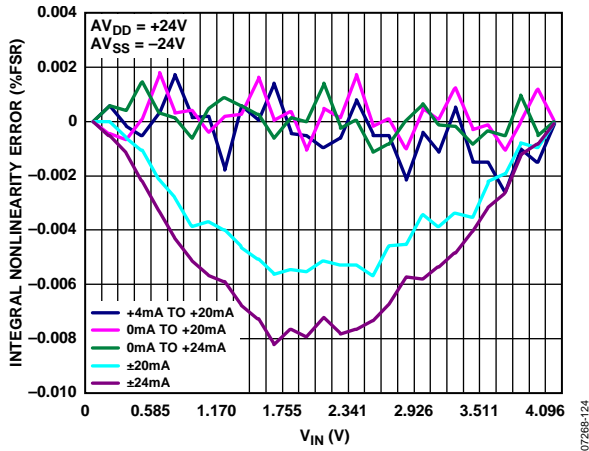

Figure 24. Integral Nonlinearity Error vs. V_{IN} , External R_{SET} Resistor

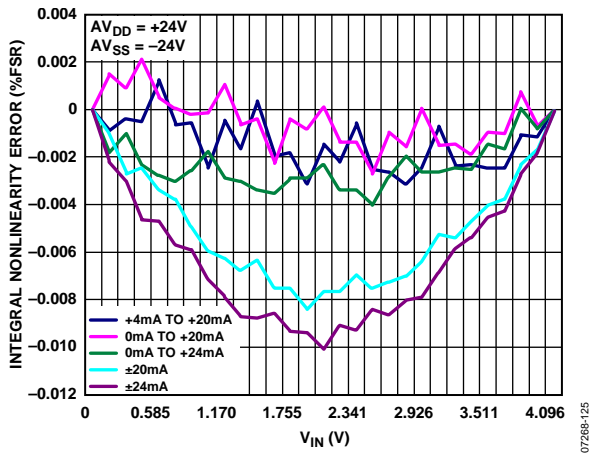

Figure 25. Integral Nonlinearity Error vs. V_{IN} , Internal R_{SET} Resistor

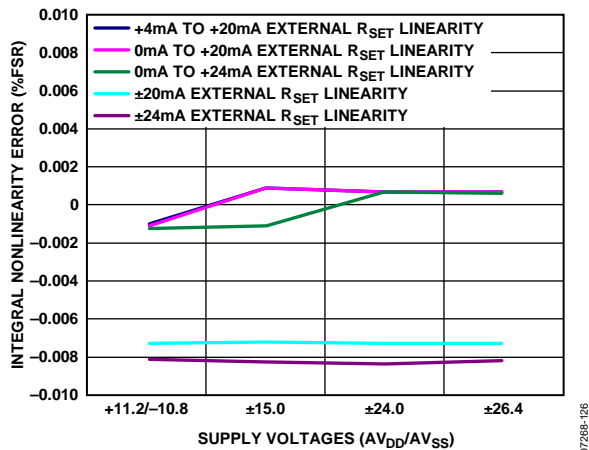

Figure 26. Integral Nonlinearity Error, Current Mode, External R_{SET} Sense Resistor

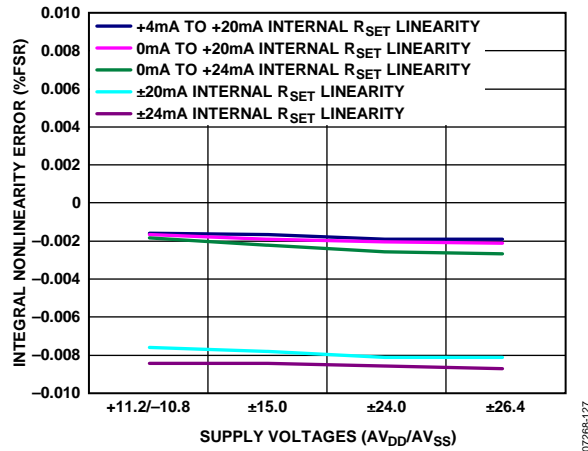

Figure 27. Integral Nonlinearity Error, Current Mode, Internal R_{SET} Sense Resistor

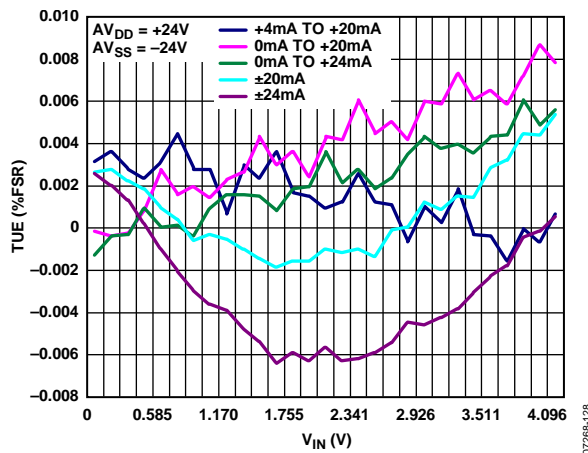

Figure 28. Total Unadjusted Error (TUE) vs. V_{IN} , External R_{SET} Resistor

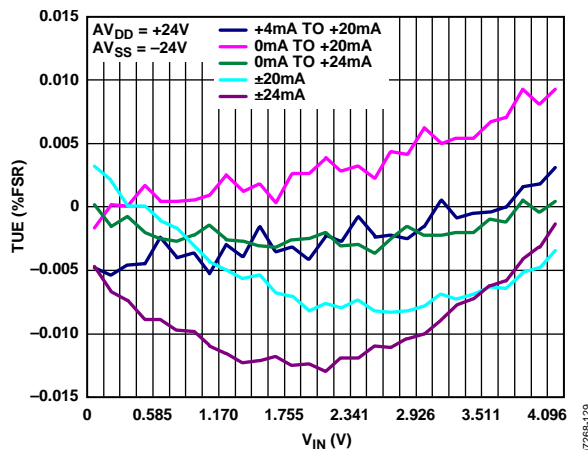

Figure 29. Total Unadjusted Error vs. V_{IN} , Internal R_{SET} Resistor

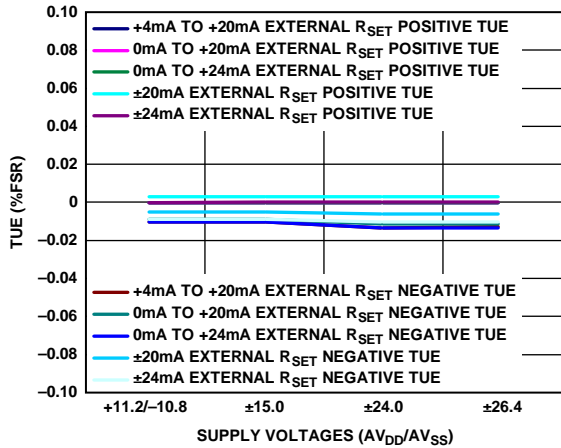

Figure 30. Total Unadjusted Error (TUE), Current Mode, External R_{SET} Sense Resistor

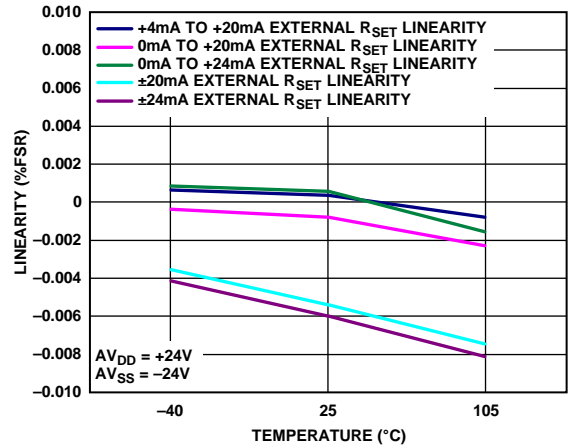

Figure 33. INL vs. Temperature, External R_{SET} Sense Resistor

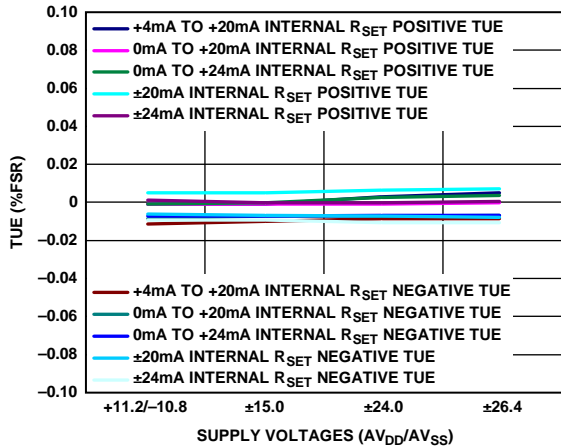

Figure 31. Total Unadjusted Error (TUE), Current Mode, Internal R_{SET} Sense Resistor

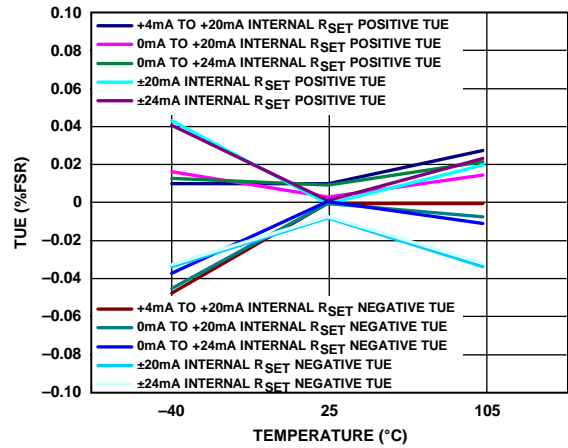

Figure 34. Total Unadjusted Error (TUE) vs. Temperature, Internal R_{SET} Sense Resistor

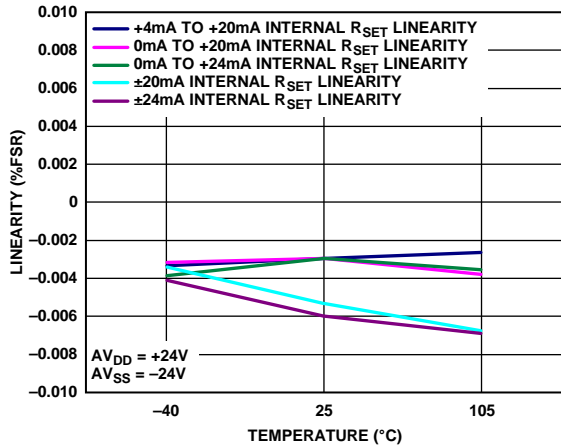

Figure 32. INL vs. Temperature, Internal R_{SET} Sense Resistor

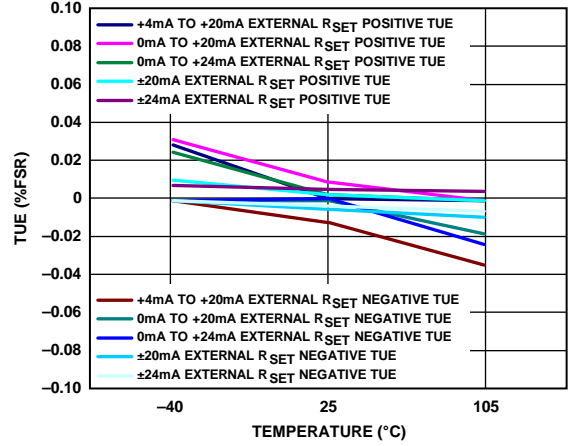

Figure 35. Total Unadjusted Error (TUE) vs. Temperature, External R_{SET} Sense Resistor

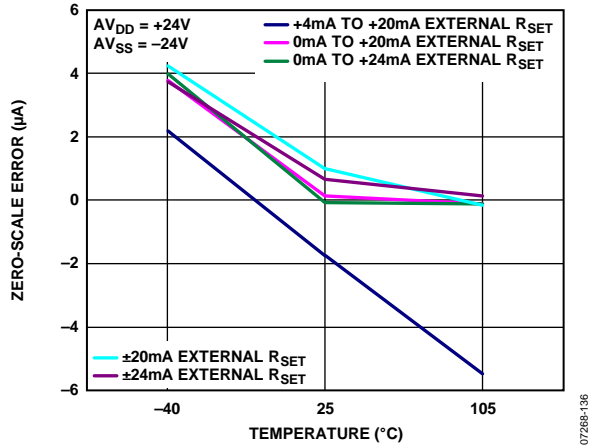

Figure 36. Zero-Scale Error vs. Temperature, External R_{SET} Sense Resistor

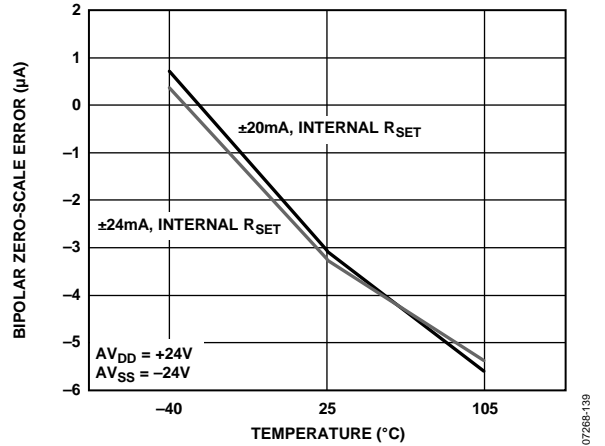

Figure 39. Bipolar Zero-Scale Error vs. Temperature, Internal R_{SET} Sense Resistor

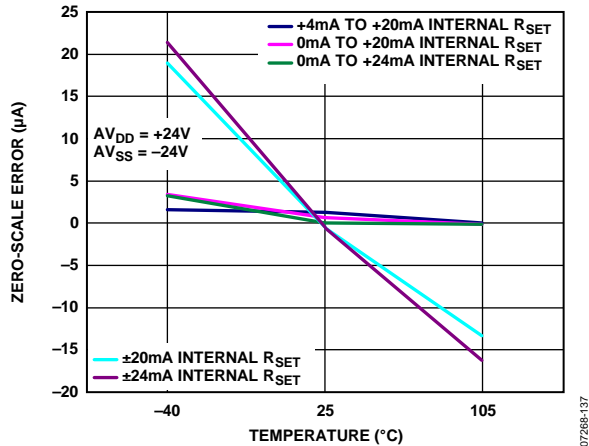

Figure 37. Zero-Scale Error vs. Temperature, Internal R_{SET} Sense Resistor

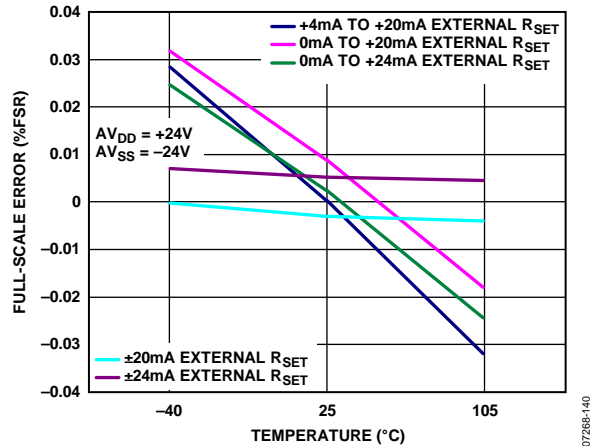

Figure 40. Full-Scale Error vs. Temperature, External R_{SET} Sense Resistor

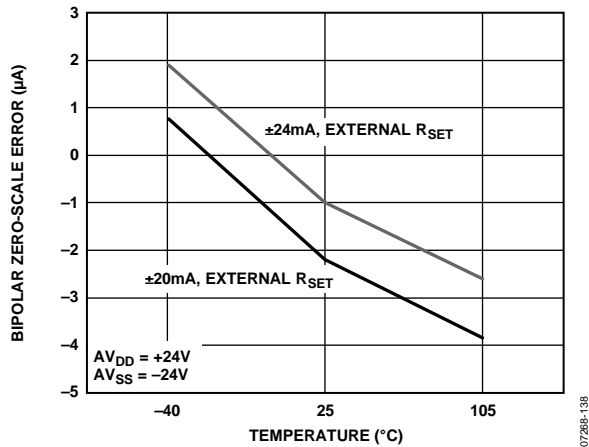

Figure 38. Bipolar Zero-Scale Error vs. Temperature, External R_{SET} Sense Resistor

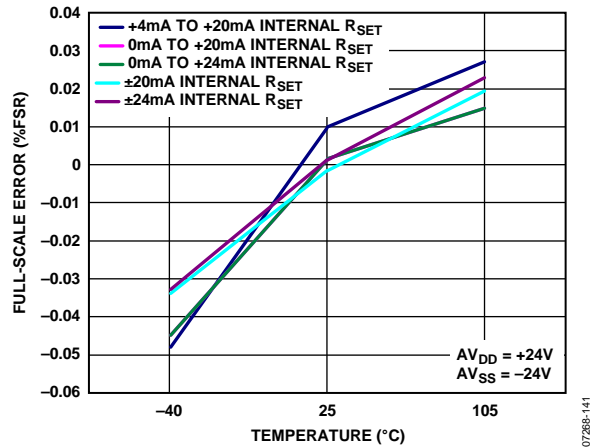

Figure 41. Full-Scale Error vs. Temperature, Internal R_{SET} Sense Resistor

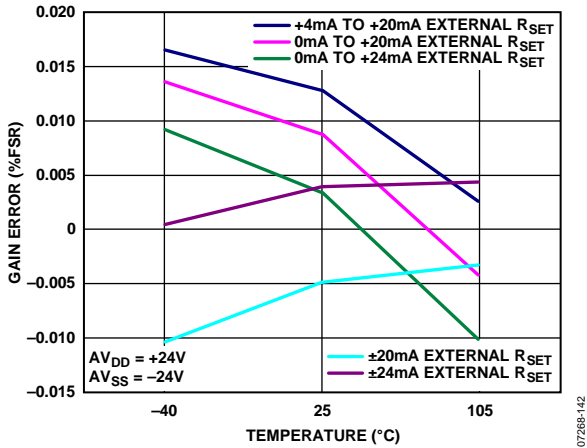

Figure 42. Gain Error vs. Temperature, External R_{SET} Sense Resistor

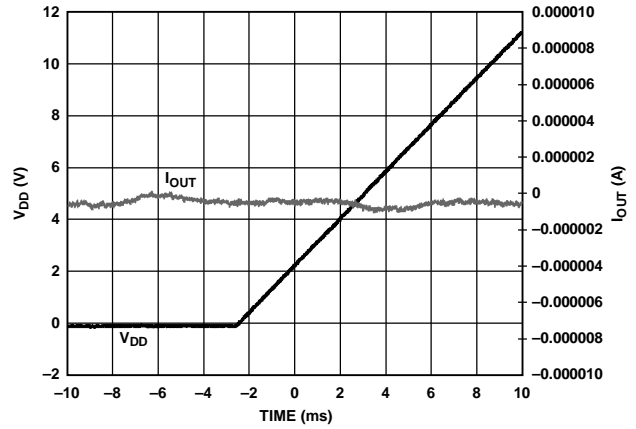

Figure 45. V_{DD} and Output Current (I_{OUT}) vs. Time-On Power-Up

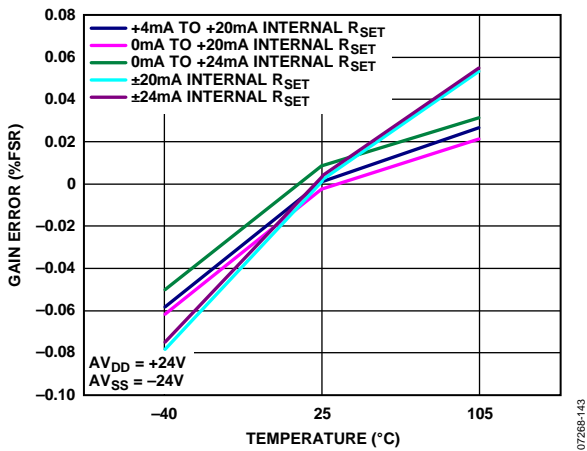

Figure 43. Gain Error vs. Temperature, Internal R_{SET} Sense Resistor

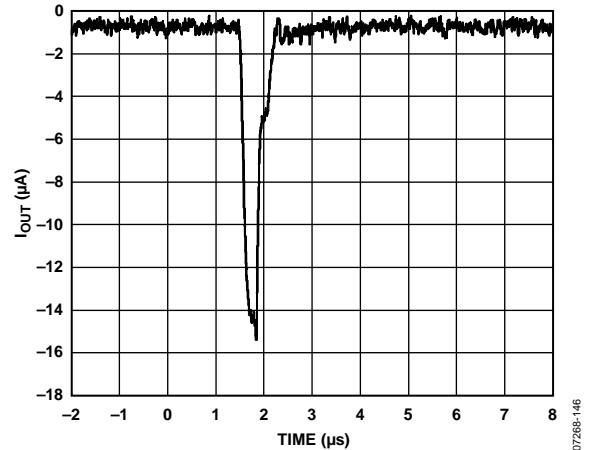

Figure 46. Output Current (I_{OUT}) vs. Time-On Output Enable

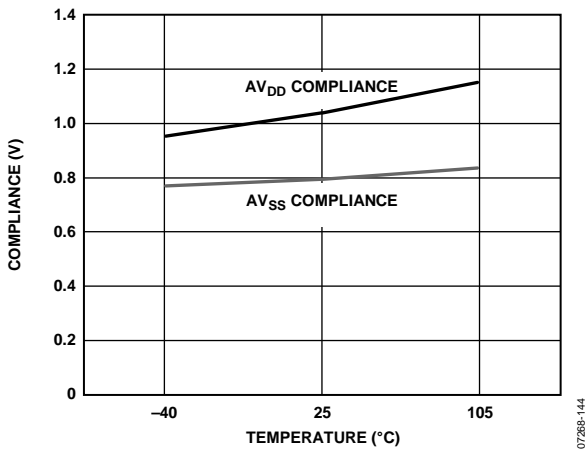

Figure 44. Output Compliance vs. Temperature Tested When $I_{OUT} = 10.8\text{ mA}$, $\pm 24\text{ mA}$ Range Selected

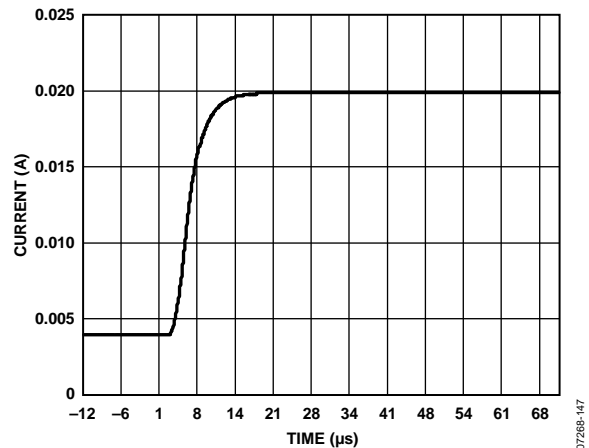

Figure 47. 4 mA to 20 mA Output Current Step

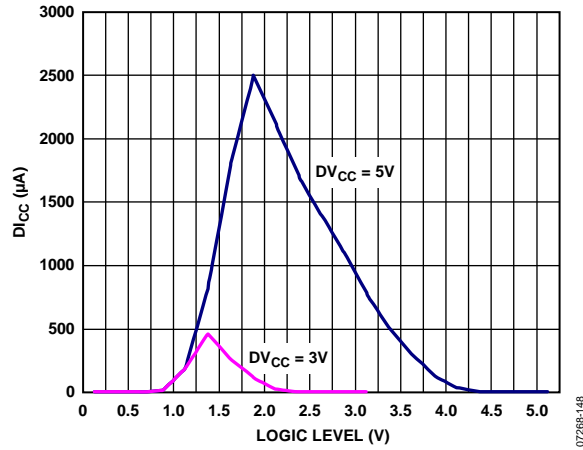

Figure 48. D_{Icc} vs. Logic Input Voltage

07268-148

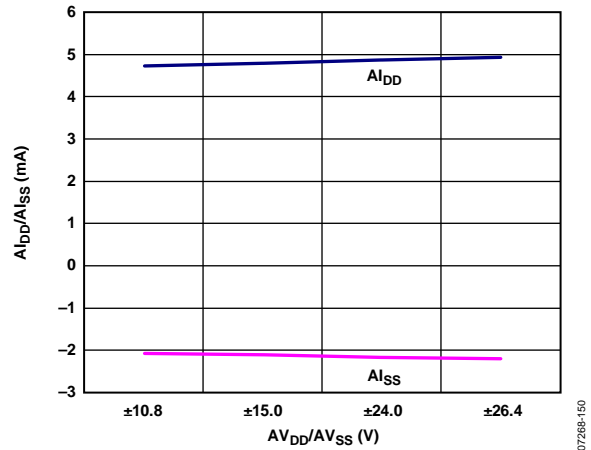

Figure 50. A_{I_{DD}}/A_{I_{SS}} vs. AV_{DD}/AV_{SS}, I_{OUT} = 0 mA

07268-150

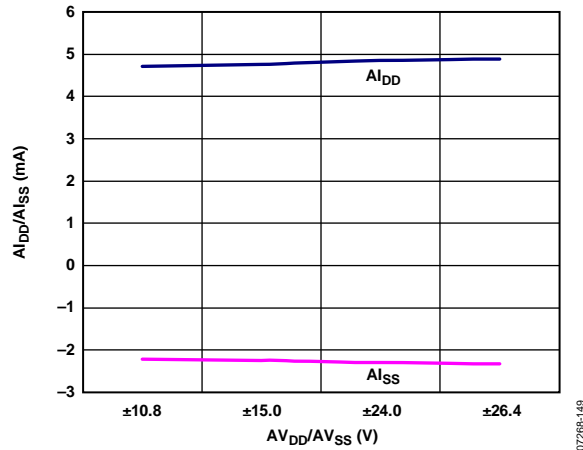

Figure 49. A_{I_{DD}}/A_{I_{SS}} vs. AV_{DD}/AV_{SS}, V_{OUT} = 0 V

07268-149

TERMINOLOGY

Total Unadjusted Error (TUE)

TUE is a measure of the output error taking all the various errors into account: INL error, offset error, gain error, and output drift over supplies, temperature, and time. TUE is expressed as a percentage of full-scale range (% FSR).

Relative Accuracy or Integral Nonlinearity (INL)

INL is a measure of the maximum deviation, in % FSR, from a straight line passing through the endpoints of the output driver transfer function. A typical INL vs. input voltage plot can be seen in Figure 5.

Bipolar Zero Error

Bipolar zero error is the deviation of the actual vs. ideal half-scale output of 0 V/0 mA with a bipolar range selected. A plot of bipolar zero error vs. temperature can be seen in Figure 10.

Bipolar Zero Temperature Coefficient (TC)

Bipolar zero TC is a measure of the change in the bipolar zero error with a change in temperature. It is expressed in ppm FSR/°C.

Full-Scale Error

Full-scale error is the deviation of the actual full-scale analog output from the ideal full-scale output. Full-scale error is expressed as a percentage of full-scale range (% FSR).

Full-Scale Temperature Coefficient (TC)

Full-scale TC is a measure of the change in the full-scale error with a change in temperature. It is expressed in ppm FSR/°C.

Gain Error

Gain error is a measure of the span error of the output. It is the deviation in slope of the output transfer characteristic from the ideal expressed in % FSR. A plot of gain error vs. temperature can be seen in Figure 11.

Gain Error Temperature Coefficient (TC)

Gain error TC is a measure of the change in gain error with changes in temperature. Gain error TC is expressed in ppm FSR/°C.

Zero-Scale Error

Zero-scale error is the deviation of the actual zero-scale analog output from the ideal zero-scale output. Zero-scale error is expressed in millivolts (mV).

Zero-Scale TC

Zero-scale TC is a measure of the change in zero-scale error with a change in temperature. Zero-scale error TC is expressed in ppm FSR/°C.

Offset Error

Offset error is a measurement of the difference between the actual V_{OUT} and the ideal V_{OUT}, expressed in millivolts (mV) in the linear region of the transfer function. It can be negative or positive.

Output Voltage Settling Time

Output voltage settling time is the amount of time it takes for the output to settle to a specified level for a half-scale input change.

Slew Rate

The slew rate of a device is a limitation in the rate of change of the output voltage. The output slewing speed is usually limited by the slew rate of the amplifier used at its output. Slew rate is measured from 10% to 90% of the output signal and is expressed in V/μs.

Current Loop Voltage Compliance

Current loop voltage compliance is the maximum voltage at the I_{OUT} pin for which the output current is equal to the programmed value.

Power-On Glitch Energy

Power-on glitch energy is the impulse injected into the analog output when the AD5750/AD5750-1/AD5750-2 are powered on. It is specified as the area of the glitch in nV-sec.

Power Supply Rejection Ratio (PSRR)

PSRR indicates how the output is affected by changes in the power supply voltage.

THEORY OF OPERATION

The [AD5750/AD5750-1/AD5750-2](#) are single-channel, precision voltage/current output drivers with hardware- or software-programmable output ranges. The software ranges are configured via an SPI-/MICROWIRE-compatible serial interface. The analog input to the [AD5750/AD5750-1/AD5750-2](#) is provided from a low voltage, single-supply DAC and is internally conditioned to provide the desired output current/voltage range. Analog input ranges available are 0 V to 2.5 V ([AD5750-1/AD5750-2](#)) or 0 V to 4.096 V ([AD5750](#)).

The output current range is programmable across five current ranges: +4 mA to +20 mA, 0 mA to +20 mA, 0 mA to +24 mA, ± 20 mA, and ± 24 mA.

The voltage output is provided from a separate pin that can be configured to provide 0 V to +5 V, 0 V to +10 V, ± 5 V, or ± 10 V output ranges. An overrange of 20% is available on the voltage ranges. An overrange of 2% is available on the 4 mA to 20 mA, 0 mA to 20 mA, and 0 mA to 24 mA current ranges. The current and voltage outputs are available on separate pins. Only one output can be enabled at one time. The output range is selected by programming the R3 to R0 bits in the control register (see [Table 7](#) and [Table 8](#)).

Figure 51 and Figure 52 show a typical configuration of the [AD5750/AD5750-1/AD5750-2](#) in software mode and in hardware mode, respectively, in an output module system. The HW SELECT pin selects whether the part is configured in software or hardware mode. The analog input to the [AD5750/AD5750-1/AD5750-2](#) is provided from a low voltage, single-supply DAC, such as the [AD506x](#) or [AD566x](#), which provides an output range of 0 V to 4.096 V. The supply and reference for the DAC, as well as the reference for the [AD5750/AD5750-1/AD5750-2](#), can be supplied from a reference such as the [ADR392](#). The [AD5750/AD5750-1/AD5750-2](#) can operate from supplies up to ± 26.4 V.

SOFTWARE MODE

In current mode, software-selectable output ranges include ± 20 mA, ± 24 mA, 0 mA to +20 mA, +4 mA to +20 mA, and 0 mA to +24 mA.

In voltage mode, software-selectable output ranges include 0 V to +5 V, 0 V to +10 V, ± 5 V, and ± 10 V.

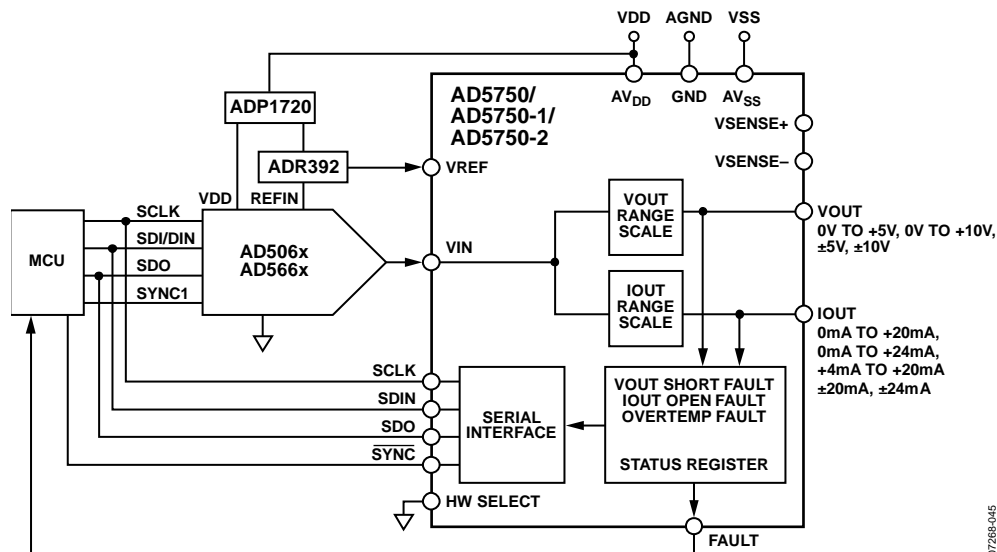

Figure 51. Typical System Configuration in Software Mode (Pull-Up Resistors Not Shown for Open-Drain Outputs)

CURRENT OUTPUT ARCHITECTURE

The voltage input from the analog input VIN pin (0 V to 4.096 V for AD5750 and 0 V to 2.5 V for the AD5750-1/AD5750-2) is either converted to a current (see Figure 53), which is then mirrored to the supply rail so that the application simply sees a current source output with respect to an internal reference voltage, or it is buffered and scaled to output a software-selectable unipolar or bipolar voltage range (see Figure 54). The reference is used to provide internal offsets for range and gain scaling. The selectable output range is programmable through the digital interface.

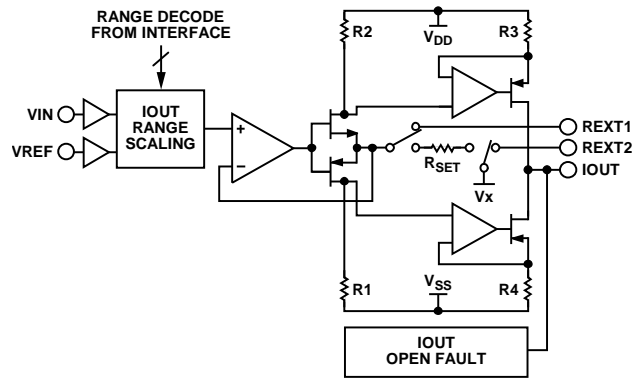

Figure 53. Current Output Configuration

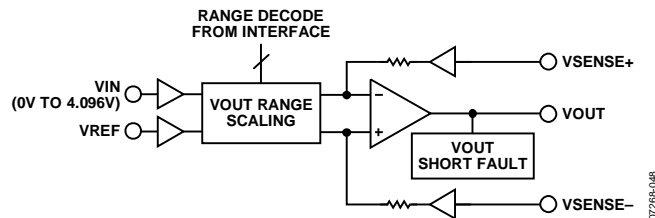

Figure 54. Voltage Output

DRIVING INDUCTIVE LOADS

When driving inductive or poorly defined loads, connect a 0.01 μF capacitor between IOUT and GND. This ensures stability with loads beyond 50 mH. There is no maximum capacitance limit. The capacitive component of the load may cause slower settling.

Voltage Output Amplifier

The voltage output amplifier is capable of generating both unipolar and bipolar output voltages. It is capable of driving a load of 1 k Ω in parallel with 1.2 μF (with an external compensation capacitor on the COMP1 and COMP2 pins). The source and sink capabilities of the output amplifier can be seen in Figure 16. The slew rate is 2 V/ μs .

Internal to the device, there is a 2.5 M Ω resistor connected between the VOUT and VSENSE+ pins and, similarly, between the VSENSE- pin and the internal device ground. If a fault condition occurs, these resistors act to protect the AD5750/AD5750-1/AD5750-2 by ensuring that the amplifier loop is closed so that the part does not enter into an open-loop condition.

The VSENSE- pin can work in a common-mode range of ± 3 V with respect to the remote load ground point.

The current and voltage are output on separate pins and cannot be output simultaneously. This allows the user to tie both the current and voltage output pins together and configure the end system as a single channel output.

Driving Large Capacitive Loads

The voltage output amplifier is capable of driving capacitive loads of up to 1 μF with the addition of a nonpolarized compensation capacitor between the COMP1 and COMP2 pins.

Without the compensation capacitor, up to 20 nF capacitive loads can be driven. Care should be taken to choose an appropriate value for the C_{COMP} capacitor. This capacitor, while allowing the AD5750/AD5750-1/AD5750-2 to drive higher capacitive loads and reduce overshoot, increases the settling time of the part and, therefore, affects the bandwidth of the system. Considered values of this capacitor should be in the range 100 pF to 4 nF, depending on the trade-off required between settling time, overshoot, and bandwidth.

POWER-ON STATE OF AD5750/AD5750-1/AD5750-2

On power-up, the AD5750/AD5750-1/AD5750-2 sense whether hardware or software mode is loaded and set the power-up conditions accordingly.

In software SPI mode, the power-up state of the output is dependent on the state of the CLEAR pin. If the CLEAR pin is pulled high, the part powers up, driving an active 0 V on the output. If the CLEAR pin is pulled low, the part powers up with the voltage output channel in tristate mode. In both cases, the current output channel powers up in the tristate condition (0 mA). This allows the voltage and current outputs to be connected together, if desired.

To put the part into normal operation, the user must set the OUTEN bit in the control register to enable the output and, in the same write, set the output range configuration using the R3 to R0 range bits. If the CLEAR pin is still high (active) during this write, the part automatically clears to its normal clear state as defined by the programmed range and by the CLRSEL pin or the CLRSEL bit (see the Asynchronous Clear (CLEAR) section for more details). To operate the part in normal mode, take the CLEAR pin low.

The CLEAR pin is typically driven directly from a microcontroller. In cases where the power supply for the AD5750/AD5750-1/AD5750-2 supply may be independent of the microcontroller power supply, connect a weak pull-up resistor to DV_{CC} or a pull-down resistor to ground to ensure that the correct power-up condition is achieved independent of the microcontroller. A 10 k Ω pull-up/pull-down resistor on the CLEAR pin should be sufficient for most applications.

If hardware mode is selected, the part powers up to the conditions defined by the R3 to R0 range bits and the status of the OUTEN or CLEAR pin. It is recommended to keep the output disabled when powering up the part in hardware mode.

DEFAULT REGISTERS AT POWER-ON

The AD5750/AD5750-1/AD5750-2 power-on-reset circuit ensures that all registers are loaded with zero code.

In software SPI mode, the part powers up with all outputs disabled (OUTEN bit = 0). The user must set the OUTEN bit in the control register to enable the output and, in the same write, to set the output range configuration using the R3 to R0 bits.

If hardware mode is selected, the part powers up to the conditions defined by the R3 to R0 bits and the status of the OUTEN pin. It is recommended to keep the output disabled when powering up the part in hardware mode.

RESET FUNCTION

In software mode, the part can be reset using the $\overline{\text{RESET}}$ pin (active low) or the reset bit (reset = 1). A reset disables both the current and voltage outputs to their power-on condition. The user must write to the OUTEN bit to enable the output and, in the same write, to set the output range configuration. The $\overline{\text{RESET}}$ pin is a level-sensitive input; the part stays in reset mode as long as the $\overline{\text{RESET}}$ pin is low. The reset bit clears to 0 following a reset command to the control register.

In hardware mode, there is no reset. If using the part in hardware mode, tie the $\overline{\text{RESET}}$ pin high.

OUTEN

In software mode, the output can be enabled or disabled using the OUTEN bit in the control register. When the output is disabled, both the current and voltage channels go into tristate. The user must set the OUTEN bit to enable the output and simultaneously set the output range configuration.

In hardware mode, the output can be enabled or disabled using the OUTEN pin. When the output is disabled, both the current and voltage channels go into tristate. The user must write to the OUTEN pin to enable the output. It is recommended that the output be disabled when changing the ranges.

SOFTWARE CONTROL

Software control is enabled by connecting the HW SELECT pin to ground. In software mode, the AD5750/AD5750-1/AD5750-2 are controlled over a versatile 3-wire serial interface that operates at clock rates up to 50 MHz. It is compatible with SPI, QSPI™, MICROWIRE, and DSP standards.

Input Shift Register

The input shift register is 16 bits wide. Data is loaded into the device MSB first as a 16-bit word under the control of the serial clock input, SCLK. Data is clocked in on the falling edge of SCLK. The input shift register consists of 16 control bits, as shown in Table 7. The timing diagram for this write operation is shown in Figure 2. The first three bits of the input shift register are used to set the hardware address of the AD5750/AD5750-1/AD5750-2 device on the printed circuit board (PCB). Up to eight devices can be addressed per board.

Bit D11, Bit D1, and Bit D0 must always be set to 0 during any write sequence.

Table 7. Input Shift Register Contents for a Write Operation—Control Register

MSB														LSB	
D15	D14	D13	D12	D11	D10	D9	D8	D7	D6	D5	D4	D3	D2	D1	D0
A2	A1	A0	R/W	0	R3	R2	R1	R0	CLRSEL	OUTEN	Clear	RSET	Reset	0	0

Table 8. Input Shift Register Descriptions

Bit	Description			
A2, A1, A0	Used in association with the AD2, AD1, and AD0 external pins to determine which part is being addressed by the system controller.			
	A2	A1	A0	Function
	0	0	0	Addresses part with Pin AD2 = 0, Pin AD1 = 0, Pin AD0 = 0.
	0	0	1	Addresses part with Pin AD2 = 0, Pin AD1 = 0, Pin AD0 = 1.
	0	1	0	Addresses part with Pin AD2 = 0, Pin AD1 = 1, Pin AD0 = 0.
	0	1	1	Addresses part with Pin AD2 = 0, Pin AD1 = 1, Pin AD0 = 1.
	1	0	0	Addresses part with Pin AD2 = 1, Pin AD1 = 0, Pin AD0 = 0.
	1	0	1	Addresses part with Pin AD2 = 1, Pin AD1 = 0, Pin AD0 = 1.
	1	1	0	Addresses part with Pin AD2 = 1, Pin AD1 = 1, Pin AD0 = 0.
	1	1	1	Addresses part with Pin AD2 = 1, Pin AD1 = 1, Pin AD0 = 1.
R/W	Indicates a read from or a write to the addressed register.			

Bit	Description					
R3, R2, R1, R0	Selects the output configuration in conjunction with RSET.					
	RSET	R3	R2	R1	R0	Output Configuration
	0	0	0	0	0	4 mA to 20 mA (external 15 k Ω current sense resistor).
	0	0	0	0	1	0 mA to 20 mA (external 15 k Ω current sense resistor).
	0	0	0	1	0	0 mA to 24 mA (external 15 k Ω current sense resistor).
	0	0	0	1	1	\pm 20 mA (external 15 k Ω current sense resistor).
	0	0	1	0	0	\pm 24 mA (external 15 k Ω current sense resistor).
	0	0	1	0	1	0 V to 5 V.
	0	0	1	1	0	0 V to 10 V.
	0	0	1	1	1	\pm 5 V.
	0	1	0	0	0	\pm 10 V.
	0	1	0	0	1	0 V to 6.0 V (20% overrange).
	0	1	0	1	0	0 V to 12.0 V (20% overrange).
	0	1	0	1	1	\pm 6.0 V (20% overrange).
	0	1	1	0	0	\pm 12.0 V (20% overrange).
	0	1	1	0	1	\pm 2.5 V.
	0	1	1	1	0	Not applicable; if selected, output drives between 0 V and -1 V.
	0	1	1	1	1	Not applicable; if selected, output drives between 0 V and -1 V.
	1	0	0	0	0	4 mA to 20 mA (internal current sense resistor).
	1	0	0	0	1	0 mA to 20 mA (internal current sense resistor).
	1	0	0	1	0	0 mA to 24 mA (internal current sense resistor).
	1	0	0	1	1	\pm 20 mA (internal current sense resistor).
	1	0	1	0	0	\pm 24 mA (internal current sense resistor).
	1	0	1	0	1	0 V to 5 V.
	1	0	1	1	0	0 V to 10 V.
	1	0	1	1	1	\pm 5 V.
	1	1	0	0	0	\pm 10 V.
	1	1	0	0	1	0 V to 6.0 V (20% overrange).
	1	1	0	1	0	0 V to 12.0 V (20% overrange).
	1	1	0	1	1	\pm 6.0 V (20% overrange).
	1	1	1	0	0	\pm 12.0 V (20% overrange).
	1	1	1	0	1	3.92 mA to 20.4 mA (internal current sense resistor).
	1	1	1	1	0	0 mA to 20.4 mA (internal current sense resistor).
	1	1	1	1	1	0 mA to 24.5 mA (internal current sense resistor).
CLRSEL	Sets clear mode to zero scale or midscale. See the Asynchronous Clear (CLEAR) section.					
	CLRSEL	Function				
	0	Clear to 0 V.				
	1	Clear to midscale in unipolar mode; clear to zero scale in bipolar mode.				
OUTEN	Output enable bit. This bit must be set to 1 to enable the outputs.					
Clear	Software clear bit, active high.					
RSET	Select internal/external current sense resistor.					
	RSET	Function				
	1	Select internal current sense resistor; used with R3 to R0 bits to select range.				
	0	Select external current sense resistor; used with R3 to R0 bits to select range.				
Reset	Resets the part to its power-on state.					

Status Bit Read Operation

A read of the status bits can be initiated as part of a normal write operation. The read is activated by selecting the correct device address (A2, A1, A0) and then setting the R/W bit to 1. By default, the SDO pin is disabled. After having addressed the [AD5750/AD5750-1/AD5750-2](#) and setting R/W to 1 the SDO pin is enabled and data is clocked out on the 5th rising edge of SCLK. After all the data has been clocked out on SDO, a rising edge on SYNC disables (tristates) the SDO pin again. Status register data (see Table 9) and control register data are both available during the same read cycle. Data contained in Bit D10 to Bit D0 of the write operation are still valid and can be used to change the operating mode of the [AD5750/AD5750-1/AD5750-2](#) if required.

The status bits comprise three read-only bits. They are used to notify the user of specific fault conditions that occur, such as an open circuit or short circuit on the output, an overtemperature error, or an interface error. If any of these fault conditions occur, a hardware FAULT is also asserted low, which can be used as a hardware interrupt to the controller.

See the Detailed Description of Features section for a full explanation of fault conditions.

HARDWARE CONTROL

Hardware control is enabled by connecting the HW SELECT pin to DV_{CC}. In this mode, the R3, R2, R1, and R0 pins, in conjunction with the RSET pin, are used to configure the output range per Table 8.

In hardware mode, there is no status register. The fault conditions (open circuit, short circuit, and overtemperature) are available on the IFAULT, VFAULT, and TEMP pins. If any one of these fault conditions are set, a low is asserted on the specific fault pin. IFAULT, VFAULT, and TEMP are open-drain outputs and, therefore, can be connected together to allow the user to generate one interrupt to the system controller to communicate a fault. If hardwired in this way, it is not possible to isolate which fault occurred in the system.

TRANSFER FUNCTION

The [AD5750/AD5750-1/AD5750-2](#) consist of an internal signal conditioning block that maps the analog input voltage to a programmed output range. The available analog input ranges are 0 V to 4.096 V ([AD5750](#)) and 0 V to 2.5 V ([AD5750-1/AD5750-2](#)).

For all ranges, both current and voltage, the [AD5750](#), [AD5750-1](#), and [AD5750-2](#) implement a straight linear mapping function, where 0 V maps to the lower end of the selected range and 4.096 V (or 2.5 V for [AD5750-1/AD5750-2](#)) maps to the upper end of the selected range.

Table 9. Input Shift Register Contents for a Read Operation—Status Register

MSB											LSB				
D15	D14	D13	D12	D11	D10	D9	D8	D7	D6	D5	D4	D3	D2	D1	D0
A2	A1	A0	1	0	R3	R2	R1	R0	CLRSEL	OUTEN	RSET	PEC Error	OVER TEMP	IOUT Fault	VOUT Fault

Table 10. Status Bit Options

Bit	Description
PEC Error	This bit is set if there is an interface error detected by CRC-8 error checking. See the Detailed Description of Features section.
OVER TEMP	This bit is set if the AD5750/AD5750-1/AD5750-2 core temperature exceeds approximately 150°C.
IOUT Fault	This bit is set if there is an open circuit on the IOUT pin.
VOUT Fault	This bit is set if there is a short circuit on the VOUT pin.

DETAILED DESCRIPTION OF FEATURES

OUTPUT FAULT ALERT—SOFTWARE MODE

In software mode, the [AD5750/AD5750-1/AD5750-2](#) are equipped with one FAULT pin; this is an open-drain output allowing several [AD5750/AD5750-1/AD5750-2](#) devices to be connected together to one pull-up resistor for global fault detection. In software mode, the FAULT pin is forced active low by any one of the following fault scenarios:

- The voltage at IOOUT attempts to rise above the compliance range due to an open-loop circuit or insufficient power supply voltage. The internal circuitry that develops the fault output avoids using a comparator with window limits because this requires an actual output error before the fault output becomes active. Instead, the signal is generated when the internal amplifier in the output stage has less than approximately 1 V of remaining drive capability. Thus, the fault output activates slightly before the compliance limit is reached. Because the comparison is made within the feedback loop of the output amplifier, the output accuracy is maintained by its open-loop gain, and an output error does not occur before the fault output becomes active.
- A short is detected on the voltage output pin (VOUT). The short-circuit current is limited to 15 mA.
- An interface error is detected due to PEC failure. See the Packet Error Checking section.
- The core temperature of the [AD5750/AD5750-1/AD5750-2](#) exceeds approximately 150°C.

OUTPUT FAULT ALERT—HARDWARE MODE

In hardware mode, the [AD5750/AD5750-1/AD5750-2](#) are equipped with three fault pins: VFAULT, IFAULT, and TEMP. These are open-drain outputs allowing several [AD5750/AD5750-1/AD5750-2](#) devices to be connected together to one pull-up resistor for global fault detection. In hardware control mode, these fault pins are forced active by any one of the following fault scenarios:

- An open circuit is detected. The voltage at IOOUT attempts to rise above the compliance range, due to an open-loop

circuit or insufficient power supply voltage. The internal circuitry that develops the fault output avoids using a comparator with window limits because this requires an actual output error before the fault output becomes active. Instead, the signal is generated when the internal amplifier in the output stage has less than approximately 1 V of remaining drive capability. Thus, the fault output activates slightly before the compliance limit is reached. Because the comparison is made within the feedback loop of the output amplifier, the output accuracy is maintained by its open-loop gain, and an output error does not occur before the fault output becomes active. If this fault is detected, the IFAULT pin is forced low.

- A short is detected on the voltage output pin (VOUT). The short-circuit current is limited to 15 mA. If this fault is detected, the VFAULT pin is forced low.
- The core temperature of the [AD5750/AD5750-1/AD5750-2](#) exceeds approximately 150°C. If this fault is detected, the TEMP pin is forced low.

VOLTAGE OUTPUT SHORT-CIRCUIT PROTECTION

Under normal operation, the voltage output sinks and sources up to 12 mA and maintains specified operation. The maximum current that the voltage output delivers is 15 mA; this is the short-circuit current.

ASYNCHRONOUS CLEAR (CLEAR)

CLEAR is an active high clear that allows the output to be cleared to either zero-scale code or midscale code and is user-selectable via the CLRSEL pin or the CLRSEL bit of the input shift register, as described in Table 8. (The clear select feature is a logical OR function of the CLRSEL pin and the CLRSEL bit). The current loop output clears to the bottom of its programmed range. When the CLEAR signal is returned low, the output returns to its programmed value or to a new programmed value. A clear operation can also be performed via the clear command in the control register (see Table 11).

Table 11. CLRSEL Options

CLRSEL	Output Clear Value			
	Unipolar Output Voltage Range	Unipolar Current Output Range	Bipolar Output Range	Bipolar Current Output Range
0	0 V	Zero scale; for example, 4 mA on the 4 mA to 20 mA range, 0 mA on the 0 mA to 20 mA range	Negative full scale	Zero scale; for example, -24 mA on the ± 24 mA range
1	Midscale	Midscale; for example, 12 mA on the 4 mA to 20 mA range, 10 mA on the 0 mA to 20 mA range	0 V	Midscale; for example, 0 mA on the ± 24 mA range

EXTERNAL CURRENT SETTING RESISTOR

Referring to Figure 1, R_{SET} is an internal sense resistor and is part of the voltage-to-current conversion circuitry. The nominal value of the internal current sense resistor is 15 k Ω . To allow for overrange capability in current mode, the user can also select the internal current sense resistor to be 14.7 k Ω , giving a nominal 2% overrange capability. This feature is available in the 0 mA to +20 mA, +4 mA to +20 mA, and \pm 20 mA current ranges.

The stability of the output current value over temperature is dependent on the stability of the value of R_{SET} . As a method of improving the stability of the output current over temperature, an external low drift resistor can be connected to the REXT1 and REXT2 pins of the AD5750/AD5750-1/AD5750-2, which can be used instead of the internal resistor. The external resistor is selected via the input shift register. If the external resistor option is not used, leave the REXT1 and REXT2 pins floating.

PROGRAMMABLE OVERRANGE MODES

The AD5750/AD5750-1/AD5750-2 contain an overrange mode for most of the available ranges. The overranges are selected by configuring the R3, R2, R1, and R0 bits (or pins) accordingly.

In voltage mode, the overranges are typically 20%, providing programmable output ranges of 0 V to +6 V, 0 V to +12 V, \pm 6 V, and \pm 12 V. The analog input remains the same.

In current mode, the overranges are typically 2%. In current mode, the overrange capability is available on only three ranges, 0 mA to 20 mA, 0 mA to 24 mA, and 4 mA to 20 mA. For these ranges, the analog input also remains the same (0 V to 4.096 V for the AD5750, and 0 V to 2.5 V for the AD5750-1/AD5750-2).

PACKET ERROR CHECKING

To verify that data has been received correctly in noisy environments, the AD5750/AD5750-1/AD5750-2 offer the option of error checking based on an 8-bit cyclic redundancy check (CRC-8). The device controlling the AD5750/AD5750-1/AD5750-2 should generate an 8-bit frame check sequence using the following polynomial:

$$C(x) = x_8 + x_2 + x_1 + 1$$

This is added to the end of the data-word, and 24 data bits are sent to the AD5750/AD5750-1/AD5750-2 before taking SYNC high. If the AD5750/AD5750-1/AD5750-2 receive a 24-bit data frame, the parts perform the error check when SYNC goes high. If the check is valid, the data is written to the selected register. If the error check fails, the FAULT pin goes low, and Bit D3 of the status register is set. After reading this register, this error flag is cleared automatically, and the FAULT pin goes high again.

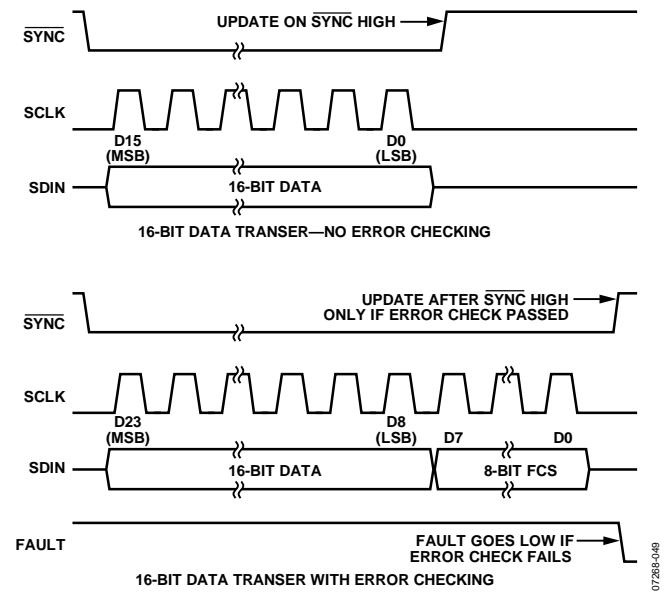

Figure 55. PEC Error Checking Timing

07268-048

APPLICATIONS INFORMATION

TRANSIENT VOLTAGE PROTECTION

The AD5750/AD5750-1/AD5750-2 contain ESD protection diodes that prevent damage from normal handling. The industrial control environment can, however, subject I/O circuits to much higher transients. To protect the AD5750/AD5750-1/AD5750-2 from excessively high voltage transients, external power diodes and a surge current limiting resistor may be required, as shown in Figure 56. The constraint on the resistor value is that during normal operation the output level at IOOUT must remain within its voltage compliance limit of $AV_{DD} - 2.75\text{ V}$ and the two protection diodes and resistor must have appropriate power ratings. Further protection can be added with transient voltage suppressors, if needed.

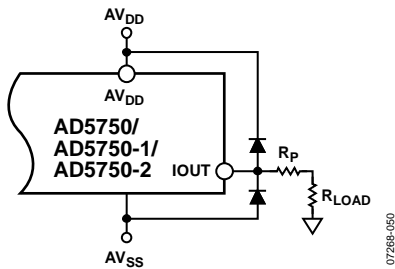

Figure 56. Output Transient Voltage Protection

THERMAL CONSIDERATIONS

It is important to understand the effects of power dissipation on the package and how it affects junction temperature. The internal junction temperature should not exceed 125°C . The AD5750/AD5750-1/AD5750-2 are packaged in a 32-lead, $5\text{ mm} \times 5\text{ mm}$ LFCSP package. The thermal impedance, θ_{JA} , is $42^{\circ}\text{C}/\text{W}$. It is important that the devices are not being operated under conditions that cause the junction temperature to exceed its junction temperature.

Worst-case conditions occur when the AD5750/AD5750-1/AD5750-2 are operated from the maximum AV_{DD} (26.4 V) and are driving the maximum current (24 mA) directly to ground. The quiescent current of the AD5750/AD5750-1/AD5750-2 should also be taken into account, nominally $\sim 4\text{ mA}$.

The following calculations estimate maximum power dissipation under these worst-case conditions and determine the maximum ambient temperature:

$$\text{Power Dissipation} = 26.4\text{ V} \times 28\text{ mA} = 0.7392\text{ W}$$

$$\text{Temperature Increase} = 42^{\circ}\text{C} \times 0.7392\text{ W} = 31^{\circ}\text{C}$$

$$\text{Maximum Ambient Temperature} = 125^{\circ}\text{C} - 31^{\circ}\text{C} = 94^{\circ}\text{C}$$

These figures assume that proper layout and grounding techniques are followed to minimize power dissipation, as outlined in the Layout Guidelines section.

LAYOUT GUIDELINES

In any circuit where accuracy is important, careful consideration of the power supply and ground return layout helps to ensure the rated performance. The PCB on which the AD5750/AD5750-1/AD5750-2 are mounted should be designed so that the AD5750/AD5750-1/AD5750-2 lie on the analog plane.

The AD5750/AD5750-1/AD5750-2 should have ample supply bypassing of $10\text{ }\mu\text{F}$ in parallel with $0.1\text{ }\mu\text{F}$ on each supply located as close to the package as possible, ideally right up against the device. The $10\text{ }\mu\text{F}$ capacitors are the tantalum bead type. The $0.1\text{ }\mu\text{F}$ capacitor should have low effective series resistance (ESR) and low effective series inductance (ESI) such as the common ceramic types, which provide a low impedance path to ground at high frequencies to handle transient currents due to internal logic switching.

In systems where there are many devices on one board, it is often useful to provide some heat sinking capability to allow the power to dissipate easily.

The AD5750/AD5750-1/AD5750-2 have an exposed paddle beneath the device. Connect this paddle to the AV_{SS} supply of the part. For optimum performance, use special considerations to design the motherboard and to mount the package. For enhanced thermal, electrical, and board level performance, solder the exposed paddle on the bottom of the package to the corresponding thermal land paddle on the PCB. Design thermal vias into the PCB land paddle area to further improve heat dissipation.

The AV_{SS} plane on the device can be increased (as shown in Figure 57) to provide a natural heat sinking effect.

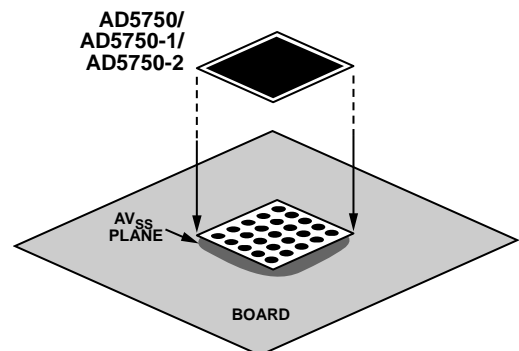

Figure 57. Paddle Connection to Board

GALVANICALLY ISOLATED INTERFACE

In many process control applications, it is necessary to provide an isolation barrier between the controller and the unit being controlled to protect and isolate the controlling circuitry from any hazardous common-mode voltages that may occur. The iCoupler® family of products from Analog Devices, Inc., provides voltage isolation in excess of 5.0 kV. The serial loading structure of the AD5750/AD5750-1/AD5750-2 makes it ideal for isolated interfaces because the number of interface lines is kept to a minimum. Figure 58 shows a 4-channel isolated interface using an ADuM1400. For further information, visit <http://www.analog.com/icouplers>.

MICROPROCESSOR INTERFACING

Microprocessor interfacing to the AD5750/AD5750-1/AD5750-2 is via a serial bus that uses a protocol that is compatible with microcontrollers and DSP processors. The communication channel is a 3-wire (minimum) interface consisting of a clock signal, a data signal, and a SYNC signal. The AD5750/AD5750-1/AD5750-2 require a 16-bit data-word with data valid on the falling edge of SCLK.

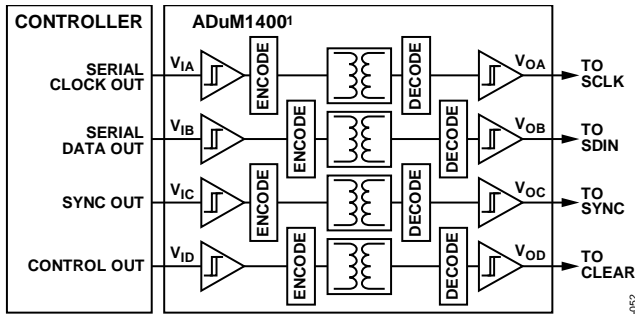

¹ADDITIONAL PINS OMITTED FOR CLARITY.

Figure 58. Isolated Interface

07288-052

OUTLINE DIMENSIONS

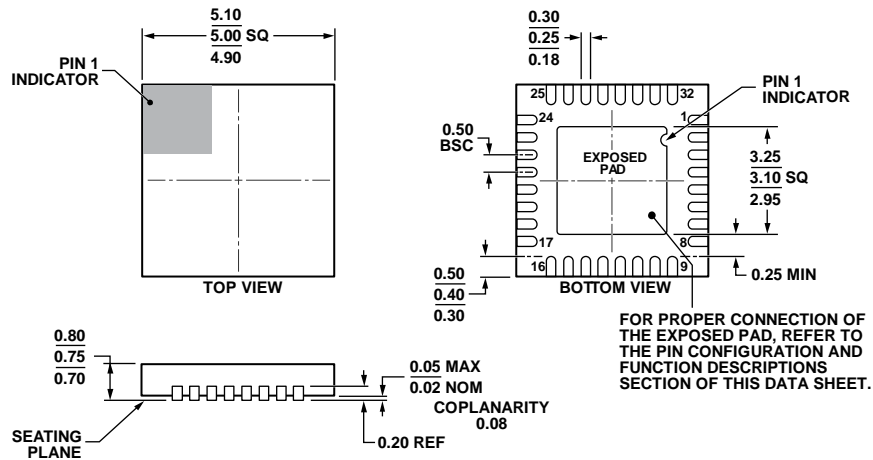

COMPLIANT TO JEDEC STANDARDS MO-220-WHHD.

Figure 59. 32-Lead Lead Frame Chip Scale Package [LFCSP_WQ]
 5 mm × 5 mm Body, Very Very Thin Quad
 (CP-32-7)
 Dimensions shown in millimeters

112408-A

ORDERING GUIDE

Model ¹	TUE Accuracy (%)	Analog Input Range (V)	External Reference (V)	Temperature Range	Package Description	Package Option
AD5750ACPZ	±0.3	0 to 4.096	4.096	-40°C to +105°C	32-Lead LFCSP_WQ	CP-32-7
AD5750ACPZ-REEL7	±0.3	0 to 4.096	4.096	-40°C to +105°C	32-Lead LFCSP_WQ	CP-32-7
AD5750BCPZ	±0.1	0 to 4.096	4.096	-40°C to +105°C	32-Lead LFCSP_WQ	CP-32-7
AD5750BCPZ-REEL7	±0.1	0 to 4.096	4.096	-40°C to +105°C	32-Lead LFCSP_WQ	CP-32-7
EVAL-AD5750EBZ					Evaluation Board	
AD5750-1ACPZ	±0.3	0 to 2.5	1.25	-40°C to +105°C	32-Lead LFCSP_WQ	CP-32-7
AD5750-1ACPZ-REEL	±0.3	0 to 2.5	1.25	-40°C to +105°C	32-Lead LFCSP_WQ	CP-32-7
AD5750-1ACPZ-REEL7	±0.3	0 to 2.5	1.25	-40°C to +105°C	32-Lead LFCSP_WQ	CP-32-7
AD5750-1BCPZ	±0.1	0 to 2.5	1.25	-40°C to +105°C	32-Lead LFCSP_WQ	CP-32-7
AD5750-1BCPZ-REEL	±0.1	0 to 2.5	1.25	-40°C to +105°C	32-Lead LFCSP_WQ	CP-32-7
AD5750-1BCPZ-REEL7	±0.1	0 to 2.5	1.25	-40°C to +105°C	32-Lead LFCSP_WQ	CP-32-7
AD5750-2BCPZ	±0.1	0 to 2.5	2.5	-40°C to +105°C	32-Lead LFCSP_WQ	CP-32-7
AD5750-2BCPZ-RL7	±0.1	0 to 2.5	2.5	-40°C to +105°C	32-Lead LFCSP_WQ	CP-32-7

¹ Z = RoHS Compliant Part.

NOTES

NOTES

NOTES

Looking for pricing, stock, or lifecycle information?

Click below to explore more details on WIN SOURCE:

 [View AD5750ACPZ on WIN SOURCE](#)

 [Analog Devices Inc. Information](#)

Optimize Your Supply Chain with WIN SOURCE Solutions

-  Global Sourcing Solution
-  Obsolete Management
-  Cost Control Management
-  Shortage Management
-  Alternative Solution
-  Excess Inventory Management