



**THE DATASHEET OF  
BSC011N03LS**



## MOSFET

OptiMOS™ Power-MOSFET, 30 V

### Features

- Optimized for high performance buck converter
- 175°C rated
- Very low on-resistance  $R_{DS(on)}$  @  $V_{GS}=4.5\text{ V}$
- 100% avalanche tested
- Superior thermal resistance
- N-channel
- Pb-free lead plating; RoHS compliant
- Halogen-free according to IEC61249-2-21

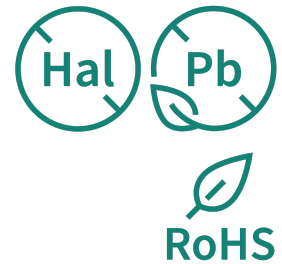
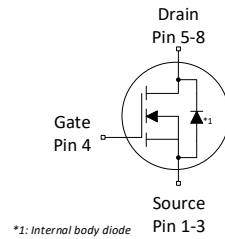
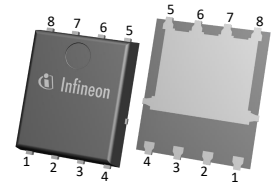
### Product validation

Fully qualified according to JEDEC for Industrial Applications

**Table 1 Key Performance Parameters**

Parameter	Value	Unit
$V_{DS}$	30	V
$R_{DS(on),max}$	1.1	mΩ
$I_D$	240	A
$Q_{OSS}$	40	nC
$Q_G(0V..10V)$	72	nC

PG-TDSON-8



Type/Ordering Code	Package	Marking	Related Links
BSC011N03LS	PG-TDSON-8	011N03LS	-



## Table of Contents

Description .....	1
Maximum ratings .....	3
Thermal characteristics .....	4
Electrical characteristics .....	5
Electrical characteristics diagrams .....	7
Package Outlines .....	11
Revision History .....	14
Trademarks .....	14
Disclaimer .....	14

## 1 Maximum ratings

unless otherwise specified

**Table 2 Maximum ratings**

Parameter	Symbol	Values			Unit	Note/ Test Condition
		Min.	Typ.	Max.		
Continuous drain current <sup>1)</sup>	$I_D$	-	-	240	A	$V_{GS}=10\text{ V}, T_C=25\text{ °C}$ $V_{GS}=10\text{ V}, T_C=100\text{ °C}$ $V_{GS}=4.5\text{ V}, T_C=25\text{ °C}$ $V_{GS}=4.5\text{ V}, T_C=100\text{ °C}$ $V_{GS}=10\text{ V}, T_A=25\text{ °C}, R_{thJA}=50\text{ K/W}^2)$
				170		
				213		
				150		
				39		
Pulsed drain current <sup>3)</sup>	$I_{D,pulse}$	-	-	960	A	$T_C=25\text{ °C}$
Avalanche current, single pulse <sup>4)</sup>	$I_{AS}$	-	-	50	A	$T_C=25\text{ °C}$
Avalanche energy, single pulse	$E_{AS}$	-	-	190	mJ	$I_D=50\text{ A}, R_{GS}=25\text{ }\Omega$
Gate source voltage <sup>5)</sup>	$V_{GS}$	-20	-	20	V	-
Power dissipation	$P_{tot}$	-	-	115	W	$T_C=25\text{ °C}$ $T_A=25\text{ °C}, R_{thJA}=50\text{ K/W}^2)$
				3.0		
Operating and storage temperature	$T_j, T_{stg}$	-55	-	175	°C	-

<sup>1)</sup> Rating refers to the product only with datasheet specified absolute maximum values, maintaining case temperature at 25°C. For higher case temperature please refer to Diagram 2. De-rating will be required based on the actual environmental conditions.

<sup>2)</sup> Device on 40 mm x 40 mm x 1.5 mm epoxy PCB FR4 with 6 cm<sup>2</sup> (one layer, 70 µm thick) copper area for drain connection. PCB is vertical in still air.

<sup>3)</sup> See Diagram 3 for more detailed information

<sup>4)</sup> See Diagram 13 for more detailed information

<sup>5)</sup> The negative rating is for low duty cycle pulse occurrence. No continuous rating is implied

## 2 Thermal characteristics

**Table 3 Thermal characteristics**

Parameter	Symbol	Values			Unit	Note/ Test Condition
		Min.	Typ.	Max.		
Thermal resistance, junction - case	$R_{thJC}$	-	-	1.3	K/W	-
Thermal resistance, junction - case, top	$R_{thJC}$	-	-	20	K/W	-
Device on PCB, 6 cm <sup>2</sup> cooling area <sup>6)</sup>	$R_{thJA}$	-	-	50	K/W	-

<sup>6)</sup> Device on 40 mm x 40 mm x 1.5 mm epoxy PCB FR4 with 6 cm<sup>2</sup> (one layer, 70 μm thick) copper area for drain connection. PCB is vertical in still air.

### 3 Electrical characteristics

unless otherwise specified

**Table 4 Static characteristics**

Parameter	Symbol	Values			Unit	Note/ Test Condition
		Min.	Typ.	Max.		
Drain-source breakdown voltage	$V_{(BR)DSS}$	30	-	-	V	$V_{GS}=0\text{ V}, I_D=1\text{ mA}$
Gate threshold voltage	$V_{GS(th)}$	1.2	-	2	V	$V_{DS}=V_{GS}, I_D=250\text{ }\mu\text{A}$
Zero gate voltage drain current	$I_{DSS}$	-	0.1 10	1 100	$\mu\text{A}$	$V_{DS}=30\text{ V}, V_{GS}=0\text{ V}, T_j=25\text{ }^\circ\text{C}$ $V_{DS}=30\text{ V}, V_{GS}=0\text{ V}, T_j=125\text{ }^\circ\text{C}$
Gate-source leakage current	$I_{GSS}$	-	10	100	nA	$V_{GS}=20\text{ V}, V_{DS}=0\text{ V}$
Drain-source on-state resistance	$R_{DS(on)}$	-	1.1 0.9	1.4 1.1	m $\Omega$	$V_{GS}=4.5\text{ V}, I_D=30\text{ A}$ $V_{GS}=10\text{ V}, I_D=30\text{ A}$
Gate resistance <sup>7)</sup>	$R_G$	0.3	0.6	1.2	$\Omega$	-
Transconductance	$g_{fs}$	85	170	-	S	$ V_{DS} >2 I_D R_{DS(on)max}, I_D=30\text{ A}$

<sup>7)</sup> Defined by design. Not subject to production test

**Table 5 Dynamic characteristics <sup>8)</sup>**

Parameter	Symbol	Values			Unit	Note/ Test Condition
		Min.	Typ.	Max.		
Input capacitance	$C_{iss}$	-	4700	6251	pF	$V_{GS}=0\text{ V}, V_{DS}=15\text{ V}, f=1\text{ MHz}$
Output capacitance	$C_{oss}$	-	1500	1995	pF	$V_{GS}=0\text{ V}, V_{DS}=15\text{ V}, f=1\text{ MHz}$
Reverse transfer capacitance	$C_{rss}$	-	220	-	pF	$V_{GS}=0\text{ V}, V_{DS}=15\text{ V}, f=1\text{ MHz}$
Turn-on delay time	$t_{d(on)}$	-	6.7	-	ns	$V_{DD}=15\text{ V}, V_{GS}=10\text{ V}, I_D=30\text{ A},$ $R_{G,ext}=1.6\text{ }\Omega$
Rise time	$t_r$	-	8.8	-	ns	$V_{DD}=15\text{ V}, V_{GS}=10\text{ V}, I_D=30\text{ A},$ $R_{G,ext}=1.6\text{ }\Omega$
Turn-off delay time	$t_{d(off)}$	-	37	-	ns	$V_{DD}=15\text{ V}, V_{GS}=10\text{ V}, I_D=30\text{ A},$ $R_{G,ext}=1.6\text{ }\Omega$
Fall time	$t_f$	-	6.2	-	ns	$V_{DD}=15\text{ V}, V_{GS}=10\text{ V}, I_D=30\text{ A},$ $R_{G,ext}=1.6\text{ }\Omega$

<sup>8)</sup> Defined by design. Not subject to production test

**Table 6 Gate charge characteristics <sup>9)</sup>**

Parameter	Symbol	Values			Unit	Note/ Test Condition
		Min.	Typ.	Max.		
Gate to source charge	$Q_{gs}$	-	11	15	nC	$V_{DD}=15\text{ V}, I_D=30\text{ A}, V_{GS}=0\text{ to }4.5\text{ V}$
Gate charge at threshold	$Q_{g(th)}$	-	7.5	-	nC	$V_{DD}=15\text{ V}, I_D=30\text{ A}, V_{GS}=0\text{ to }4.5\text{ V}$
Gate to drain charge	$Q_{gd}$	-	10.3	13	nC	$V_{DD}=15\text{ V}, I_D=30\text{ A}, V_{GS}=0\text{ to }4.5\text{ V}$

**Table 6 Gate charge characteristics** <sup>9)</sup>

Parameter	Symbol	Values			Unit	Note/ Test Condition
		Min.	Typ.	Max.		
Switching charge	$Q_{sw}$	-	14	-	nC	$V_{DD}=15\text{ V}$ , $I_D=30\text{ A}$ , $V_{GS}=0\text{ to }4.5\text{ V}$
Gate charge total	$Q_g$	-	36	48	nC	$V_{DD}=15\text{ V}$ , $I_D=30\text{ A}$ , $V_{GS}=0\text{ to }4.5\text{ V}$
Gate plateau voltage	$V_{plateau}$	-	2.4	-	V	$V_{DD}=15\text{ V}$ , $I_D=30\text{ A}$ , $V_{GS}=0\text{ to }4.5\text{ V}$
Gate charge total	$Q_g$	-	72	96	nC	$V_{DD}=15\text{ V}$ , $I_D=30\text{ A}$ , $V_{GS}=0\text{ to }10\text{ V}$
Gate charge total, sync. FET	$Q_{g(sync)}$	-	29	-	nC	$V_{DS}=0.1\text{ V}$ , $V_{GS}=0\text{ to }4.5\text{ V}$
Output charge	$Q_{oss}$	-	40	53	nC	$V_{DD}=15\text{ V}$ , $V_{GS}=0\text{ V}$

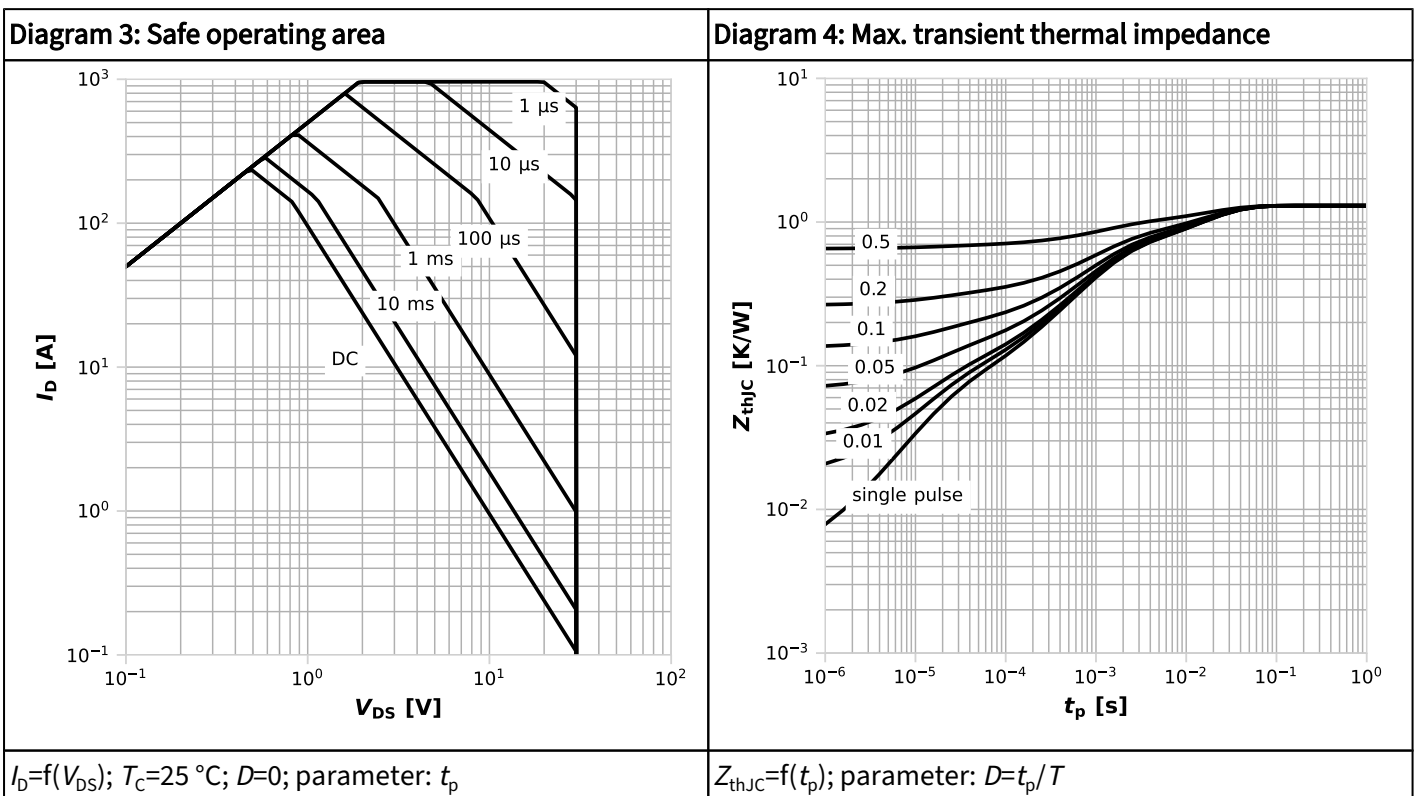
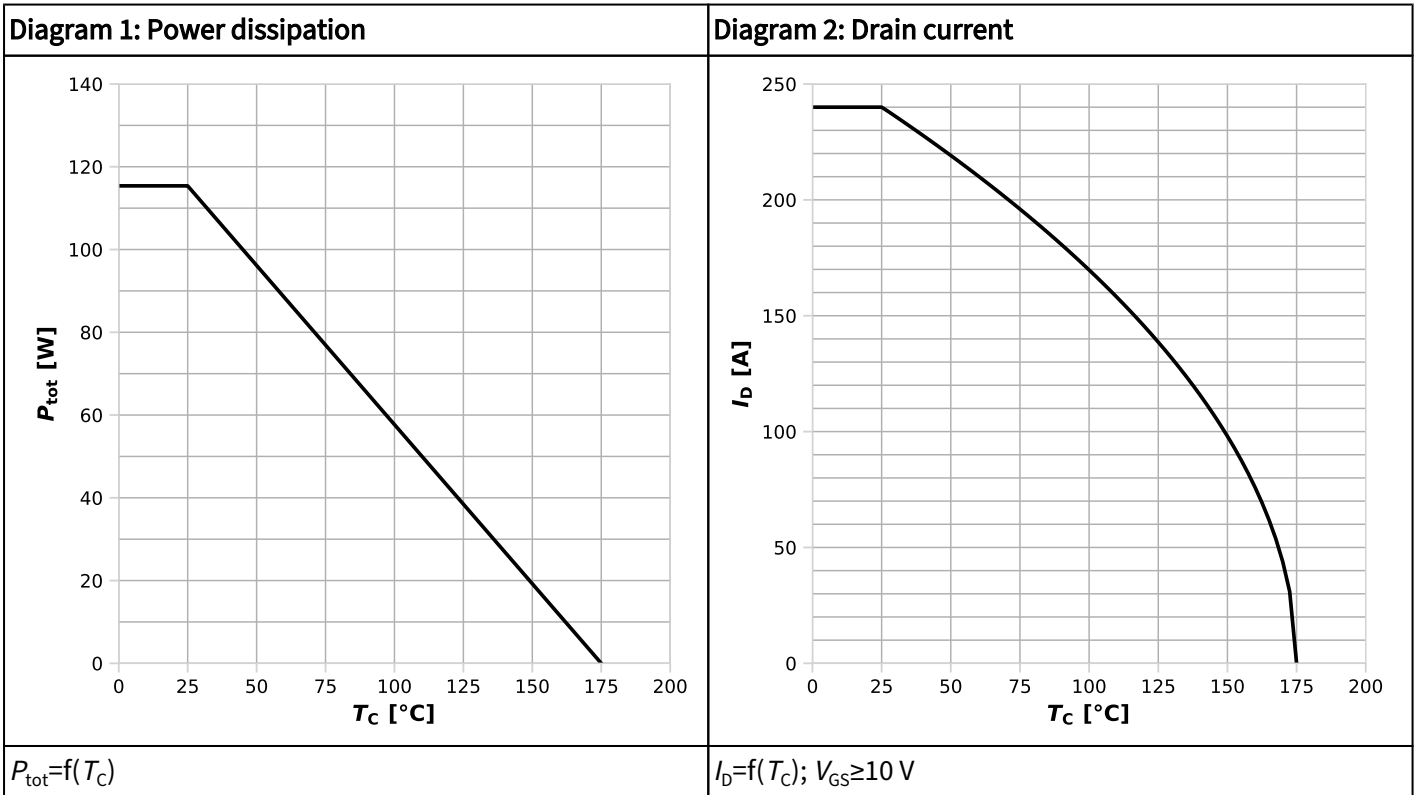
<sup>9)</sup> See "Gate charge waveforms" for parameter definition. Defined by design. Not subject to production test

**Table 7 Reverse diode**

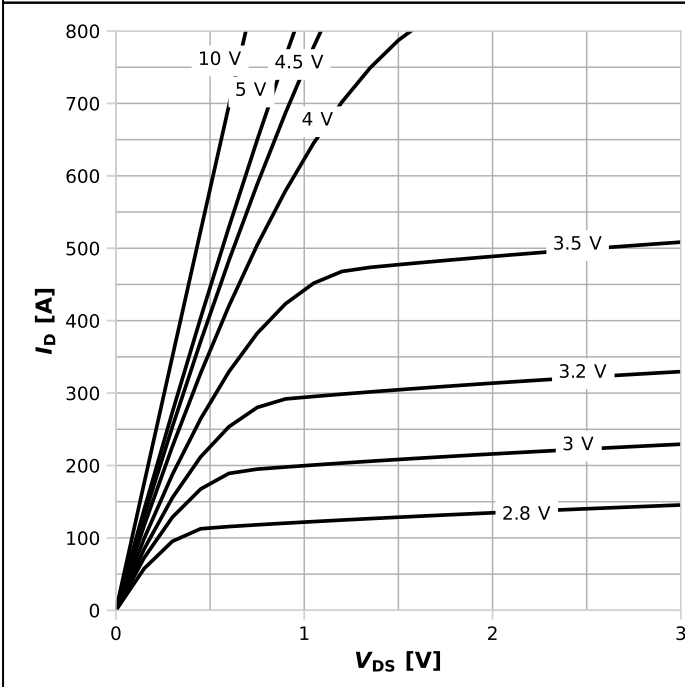
Parameter	Symbol	Values			Unit	Note/ Test Condition
		Min.	Typ.	Max.		
Diode continuous forward current	$I_S$	-	-	115	A	$T_C=25\text{ °C}$
Diode pulse current	$I_{S,pulse}$	-	-	960	A	$T_C=25\text{ °C}$
Diode forward voltage	$V_{SD}$	-	0.8	1	V	$V_{GS}=0\text{ V}$ , $I_F=30\text{ A}$ , $T_J=25\text{ °C}$
Reverse recovery charge <sup>10)</sup>	$Q_{rr}$	-	20	-	nC	$V_R=15\text{ V}$ , $I_F=I_S$ , $di_F/dt=400\text{ A}/\mu\text{s}$

<sup>10)</sup> Defined by design. Not subject to production test

## 4 Electrical characteristics diagrams

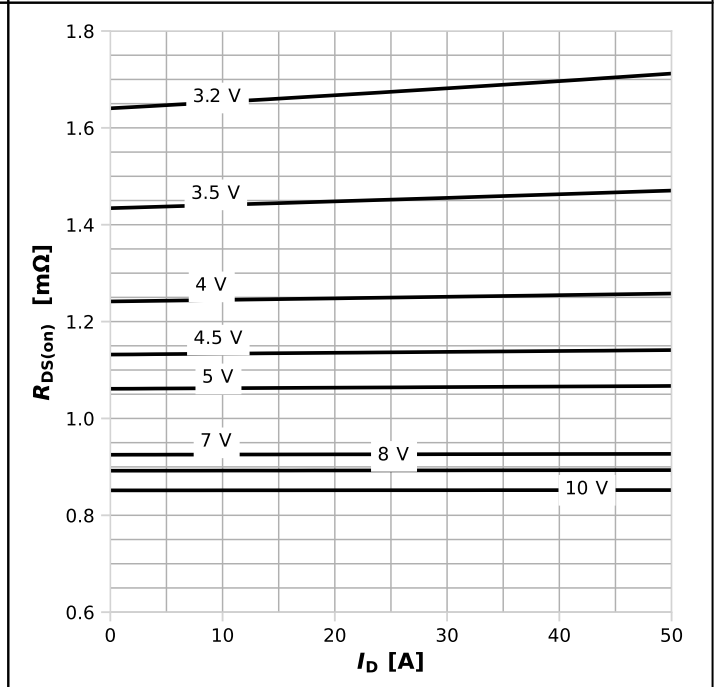


**Diagram 5: Typ. output characteristics**



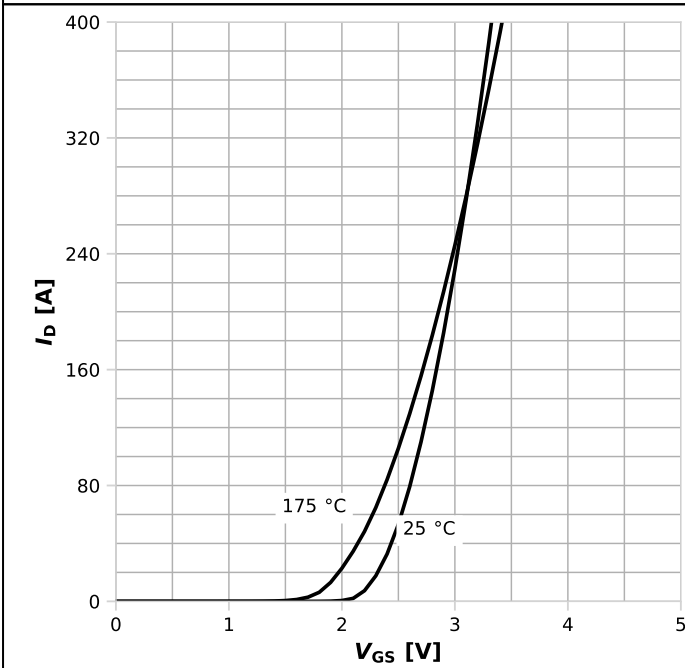
$I_D = f(V_{DS}); T_j = 25\text{ °C}; \text{parameter: } V_{GS}$

**Diagram 6: Typ. drain-source on resistance**



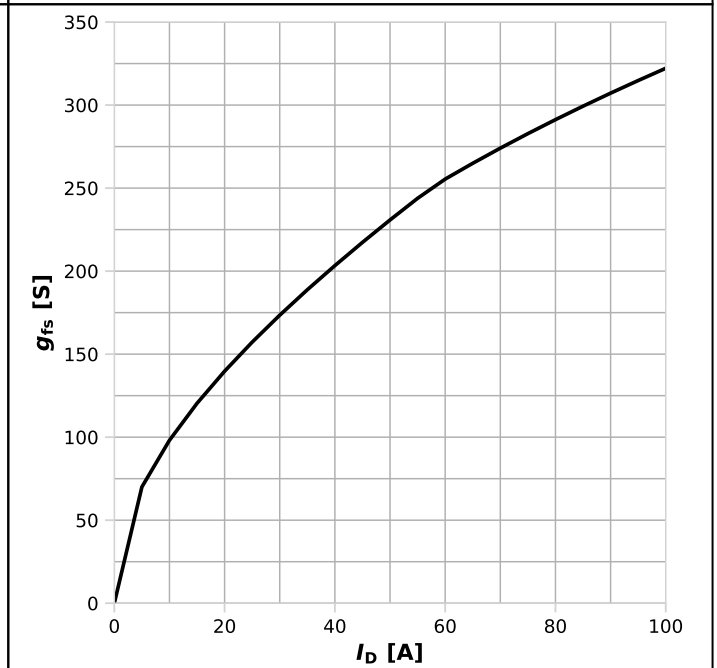
$R_{DS(on)} = f(I_D); T_j = 25\text{ °C}; \text{parameter: } V_{GS}$

**Diagram 7: Typ. transfer characteristics**



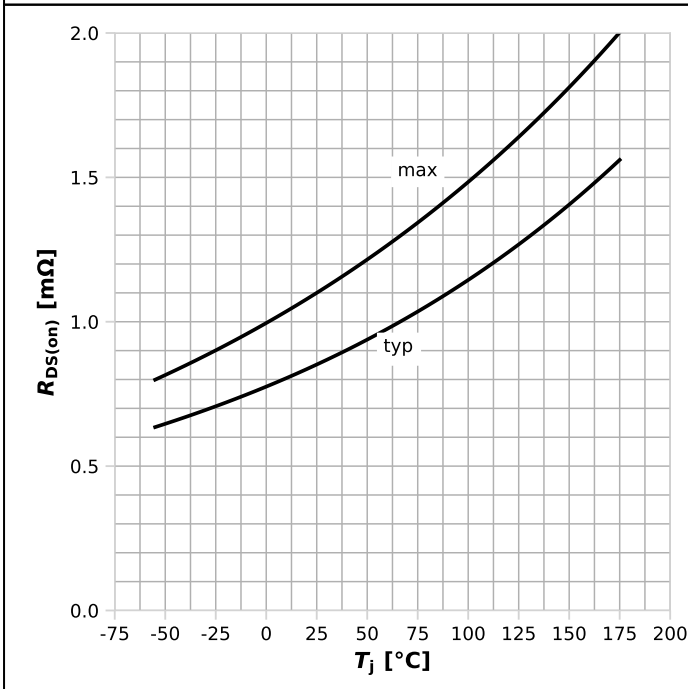
$I_D = f(V_{GS}); |V_{DS}| > 2|I_D|R_{DS(on)max}; \text{parameter: } T_j$

**Diagram 8: Typ. forward transconductance**



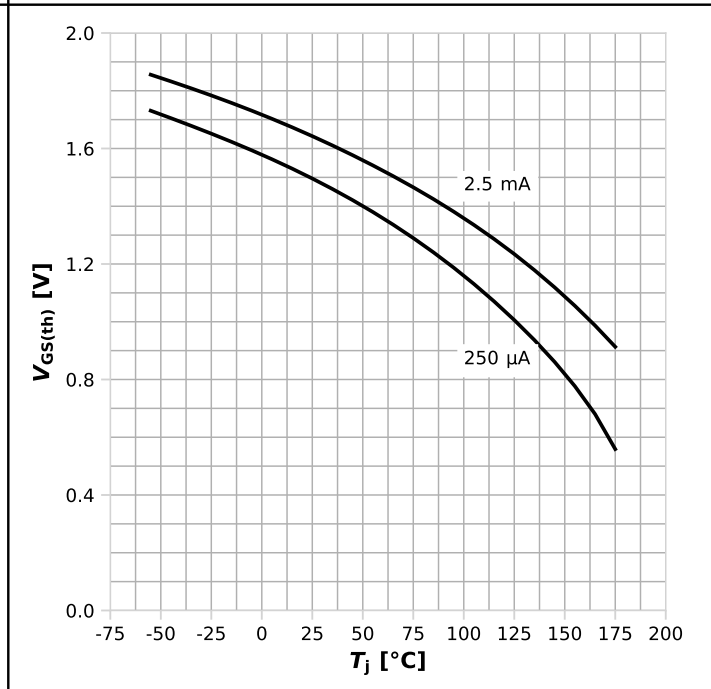
$g_{fs} = f(I_D); T_j = 25\text{ °C}$

**Diagram 9: Drain-source on-state resistance**



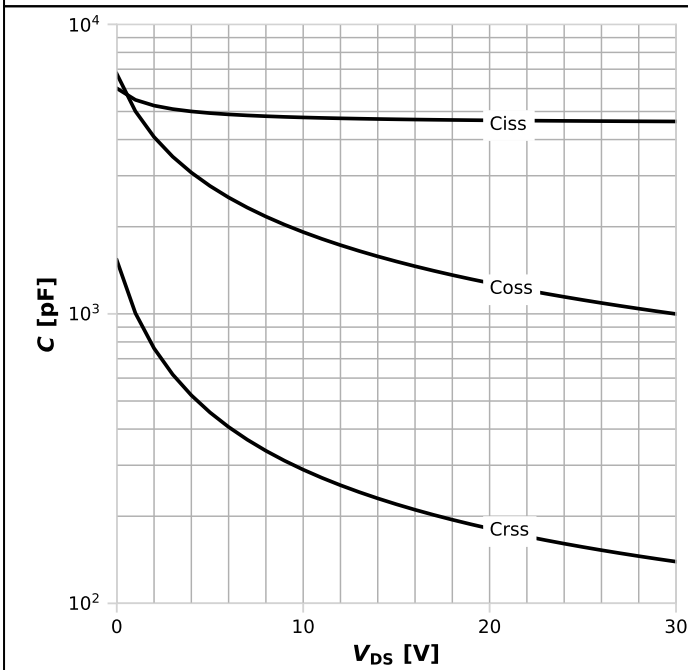
$R_{DS(on)}=f(T_j); I_D=30\text{ A}; V_{GS}=10\text{ V}$

**Diagram 10: Typ. gate threshold voltage**



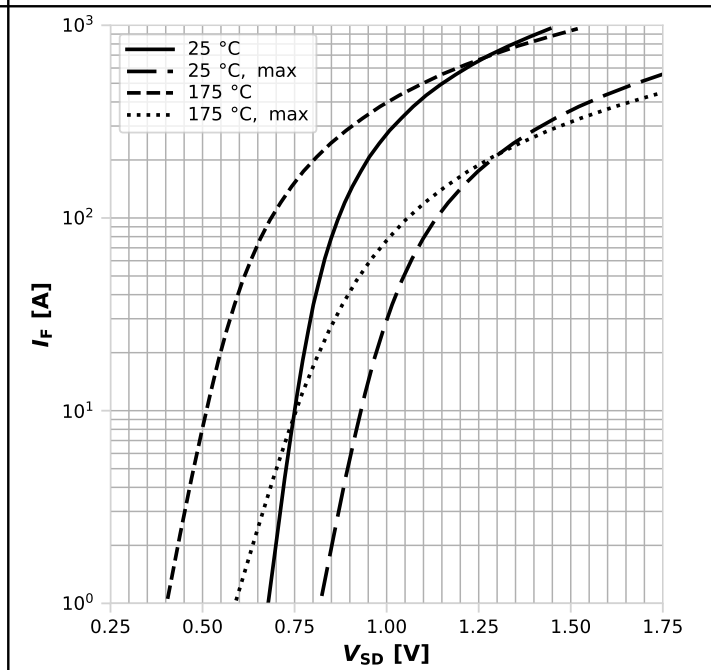
$V_{GS(th)}=f(T_j); V_{GS}=V_{DS}; I_D=250\text{ }\mu\text{A}$

**Diagram 11: Typ. capacitances**



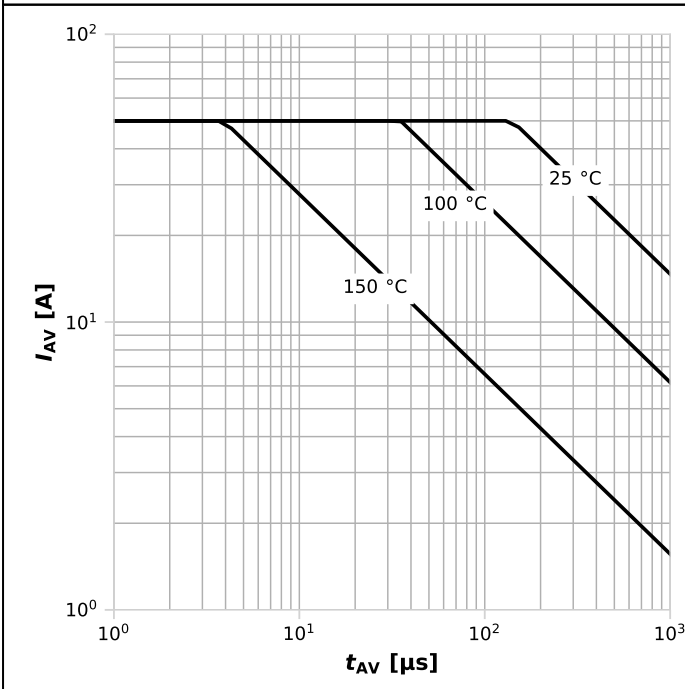
$C=f(V_{DS}); V_{GS}=0\text{ V}; f=1\text{ MHz}$

**Diagram 12: Forward characteristics of reverse diode**



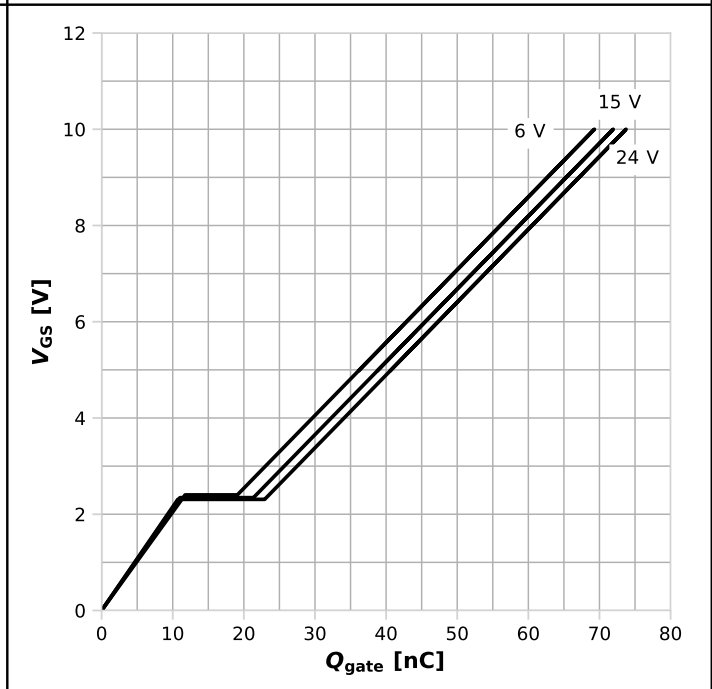
$I_F=f(V_{SD}); \text{parameter: } T_j$

**Diagram 13: Avalanche characteristics**



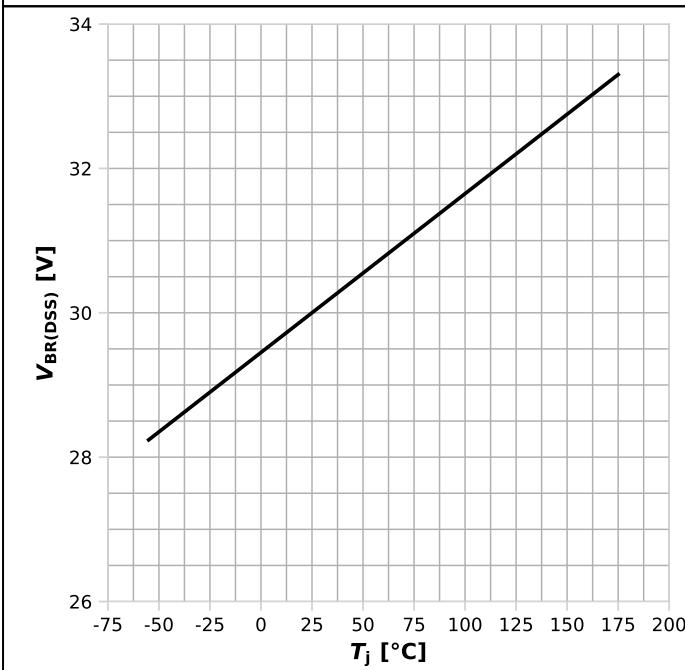
$I_{AS}=f(t_{AV}); R_{GS}=25 \Omega$ ; parameter:  $T_{j,start}$

**Diagram 14: Typ. gate charge**



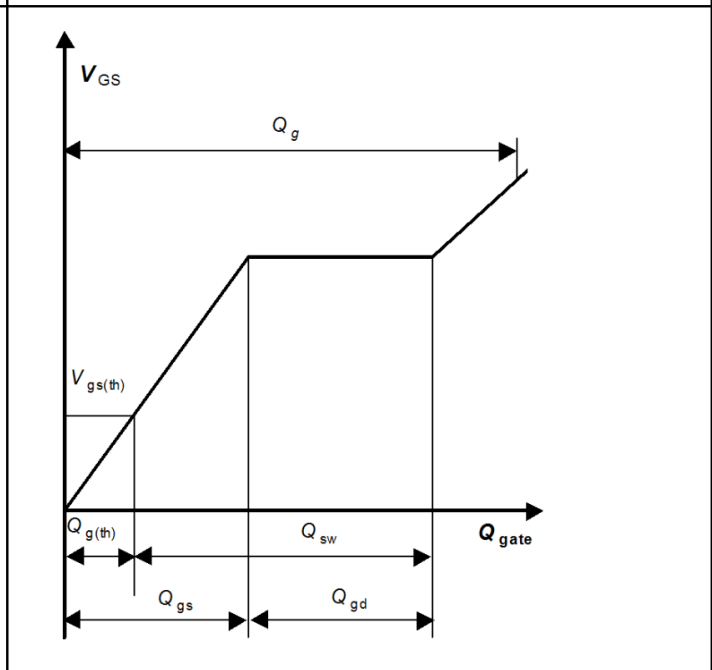
$V_{GS}=f(Q_{gate}); I_D=30 \text{ A pulsed}$ ; parameter:  $V_{DD}$

**Diagram 15: Drain-source breakdown voltage**



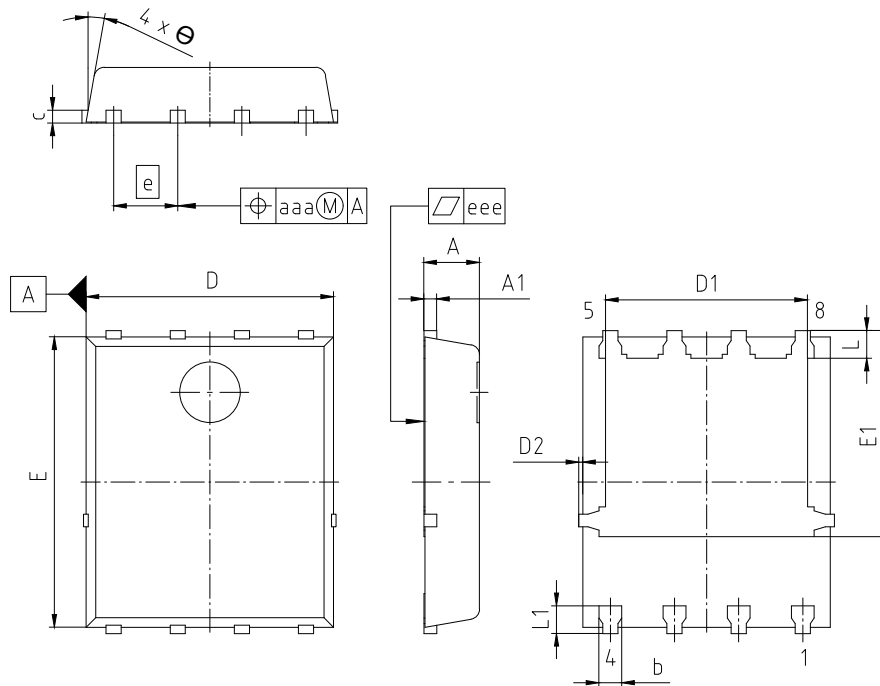
$V_{BR(DSS)}=f(T_j); I_D=1 \text{ mA}$

**Gate charge waveforms**



-

## 5 Package Outlines



PACKAGE - GROUP NUMBER: PG-TDSON-8-U08		
DIMENSIONS	MILLIMETERS	
	MIN.	MAX.
A	0.90	1.20
A1	0.15	0.35
b	0.34	0.54
c	0.15	0.35
D	4.80	5.35
D1	3.90	4.40
D2	0.00	0.22
E	5.70	6.10
E1	4.03	4.25
e	1.27	
L	0.45	0.72
L1	0.45	0.71
aaa	0.25	
eee	0.05	
θ	8°	12°

- 1) EXCLUDING MOLD FLASH
- 2) REMOVAL ON MOLD GATE  
INTRUSION 0.1 MM  
PROTRUSION 0.1 MM
- 3) ALL METAL SURFACES ARE PLATED,  
EXCEPT AREA OF CUT

Figure 1 Outline PG-TDSON-8, dimensions in mm

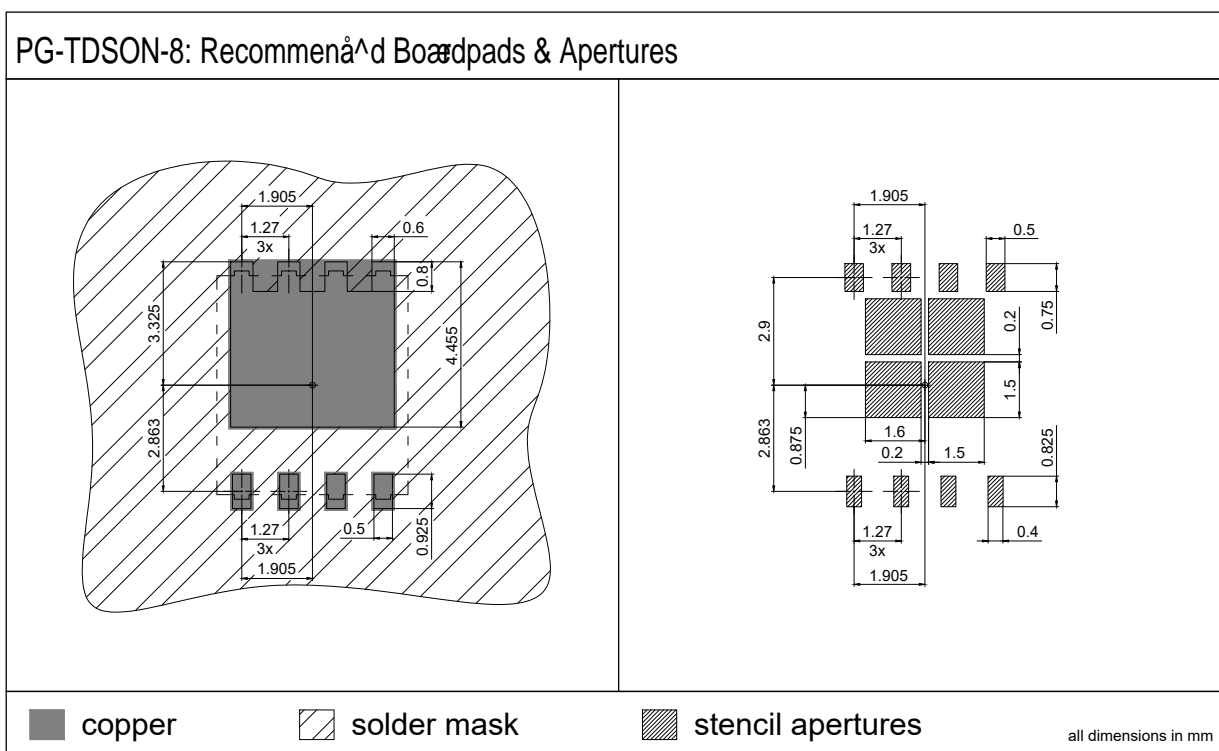
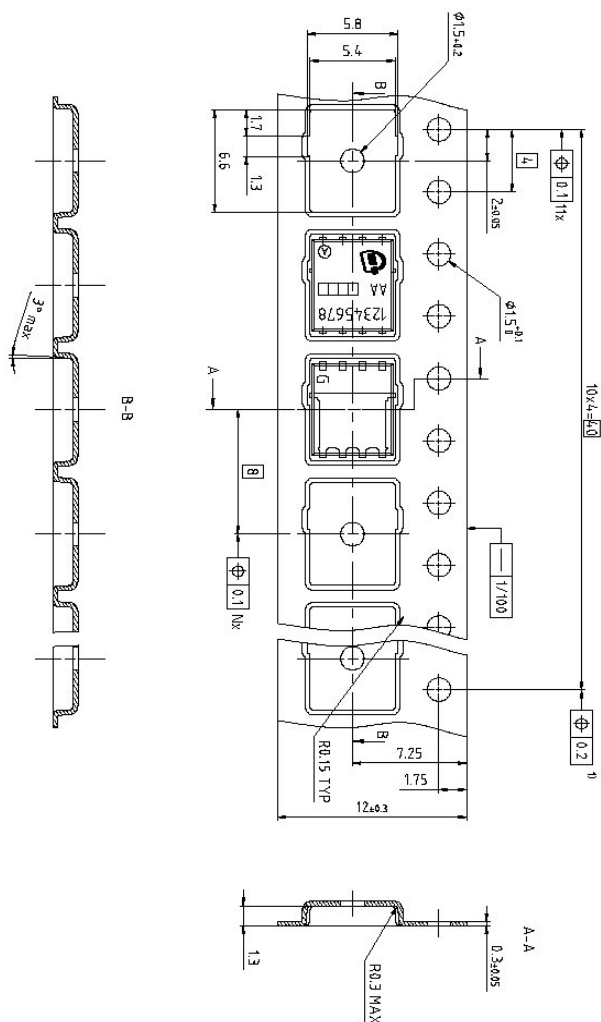


Figure 2 Outline PG-TDSON-8, dimensions in mm



Dimension in mm

Figure 3 Outline PG-TDSON-8, dimensions in mm

## Revision History

BSC011N03LS

### Revision 2024-06-04, Rev. 2.6

Previous Revision

Revision	Date	Subjects (major changes since last revision)
2.3	2019-10-01	Update package drawings
2.4	2020-03-13	Update current rating
2.5	2023-03-28	Update footnotes and package outline drawings
2.6	2024-06-04	Upgrade Operating and storage temperature max to 175°C. Update drawings in section 5 Package Outlines. Production validation added on page1.Updated foot notes.

#### Trademarks

All referenced product or service names and trademarks are the property of their respective owners.

**We Listen to Your Comments** Any information within this document that you feel is wrong, unclear or missing at all? Your feedback will help us to continuously improve the quality of this document. Please send your proposal (including a reference to this document) to: [erratum@infineon.com](mailto:erratum@infineon.com)

#### Published by

**Infineon Technologies AG**  
81726 München, Germany  
© 2024 Infineon Technologies AG  
All Rights Reserved.

#### Legal Disclaimer

The information given in this document shall in no event be regarded as a guarantee of conditions or characteristics ("Beschaffenheitsgarantie"). With respect to any examples, hints or any typical values stated herein and/or any information regarding the application of the product, Infineon Technologies hereby disclaims any and all warranties and liabilities of any kind, including without limitation warranties of non-infringement of intellectual property rights of any third party.

In addition, any information given in this document is subject to customer's compliance with its obligations stated in this document and any applicable legal requirements, norms and standards concerning customer's products and any use of the product of Infineon Technologies in customer's applications.

The data contained in this document is exclusively intended for technically trained staff. It is the responsibility of customer's technical departments to evaluate the suitability of the product for the intended application and the completeness of the product information given in this document with respect to such application.

#### Information

For further information on technology, delivery terms and conditions and prices please contact your nearest Infineon Technologies Office ([www.infineon.com](http://www.infineon.com)).



#### Warnings

Due to technical requirements, components may contain dangerous substances. For information on the types in question, please contact the nearest Infineon Technologies Office.





The Infineon Technologies component described in this Data Sheet may be used in life-support devices or systems and/or automotive, aviation and aerospace applications or systems only with the express written approval of Infineon Technologies, if a failure of such components can reasonably be expected to cause the failure of that life-support, automotive, aviation and aerospace device or system or to affect the safety or effectiveness of that device or system. Life support devices or systems are intended to be implanted in the human body or to support and/or maintain and sustain and/or protect human life. If they fail, it is reasonable to assume that the health of the user or other persons may be endangered.

## Looking for pricing, stock, or lifecycle information?

Click below to explore more details on WIN SOURCE:

-  [View BSC011N03LS on WIN SOURCE](#)
-  [Infineon Technologies Information](#)

## Optimize Your Supply Chain with WIN SOURCE Solutions

-  Global Sourcing Solution
-  Obsolete Management
-  Cost Control Management
-  Shortage Management
-  Alternative Solution
-  Excess Inventory Management