



**THE DATASHEET OF  
ADP7156ARDZ-1.8-R7**



## 1.2 A, Ultralow Noise, High PSRR, RF Linear Regulator

### FEATURES

- ▶ Input voltage range: 2.3 V to 5.5 V
- ▶ 16 standard voltages between 1.2 V and 3.3 V available
- ▶ Maximum load current: 1.2 A
- ▶ Low noise
  - ▶ 0.9  $\mu\text{V}$  rms total integrated noise from 100 Hz to 100 kHz
  - ▶ 1.6  $\mu\text{V}$  rms total integrated noise from 10 Hz to 100 kHz
- ▶ Noise spectral density: 1.7 nV/ $\sqrt{\text{Hz}}$  from 10 kHz to 1 MHz
- ▶ Power supply rejection ratio (PSRR)
  - ▶ 80 dB from 1 kHz to 100 kHz; 60 dB at 1 MHz,  $V_{\text{OUT}} = 3.3\text{ V}$ ,  $V_{\text{IN}} = 4.0\text{ V}$
- ▶ Dropout voltage: 120 mV typical at  $I_{\text{OUT}} = 1.2\text{ A}$ ,  $V_{\text{OUT}} = 3.3\text{ V}$
- ▶ Initial accuracy:  $\pm 0.6\%$  at  $I_{\text{LOAD}} = 10\text{ mA}$
- ▶ Initial accuracy over line, load, and temperature:  $\pm 1.5\%$
- ▶ Quiescent current:  $I_{\text{GND}} = 4.0\text{ mA}$  at no load, 7 mA at 1.2 A
- ▶ Low shutdown current: 0.2  $\mu\text{A}$
- ▶ Stable with a 10  $\mu\text{F}$  ceramic output capacitor
- ▶ Precision enable
- ▶ 10-lead, 3 mm  $\times$  3 mm LFCSP and 8-lead SOIC packages
- ▶ AEC-Q100 qualified for automotive applications

### APPLICATIONS

- ▶ Regulation to noise sensitive applications: phase-locked loops (PLLs), voltage controlled oscillators (VCOs), and PLLs with integrated VCOs
- ▶ Communications and infrastructure
- ▶ Backhaul and microwave links

### GENERAL DESCRIPTION

The ADP7156 is a linear regulator that operates from 2.3 V to 5.5 V and provides up to 1.2 A of output current. Using an advanced proprietary architecture, it provides high power supply rejection and ultralow noise, achieving excellent line and load transient response with only a 10  $\mu\text{F}$  ceramic output capacitor.

There are 16 standard output voltages for the ADP7156. The following voltages are available from stock: 1.2 V, 1.8 V, 2.0 V, 2.5 V, 2.8 V, 3.0 V and 3.3 V. Additional voltages available by special order are 1.3 V, 1.5 V, 1.6 V, 2.2 V, 2.6 V, 2.7 V, 2.9 V, 3.1 V, and 3.2 V.

The ADP7156 regulator typical output noise is 0.9  $\mu\text{V}$  rms from 100 Hz to 100 kHz and 1.7 nV/ $\sqrt{\text{Hz}}$  for noise spectral density from 10 kHz to 1 MHz. The ADP7156 is available in a 10-lead, 3 mm  $\times$  3 mm LFCSP and 8-lead SOIC packages, making it not only a very compact solution, but also providing excellent thermal performance

### TYPICAL APPLICATION CIRCUIT

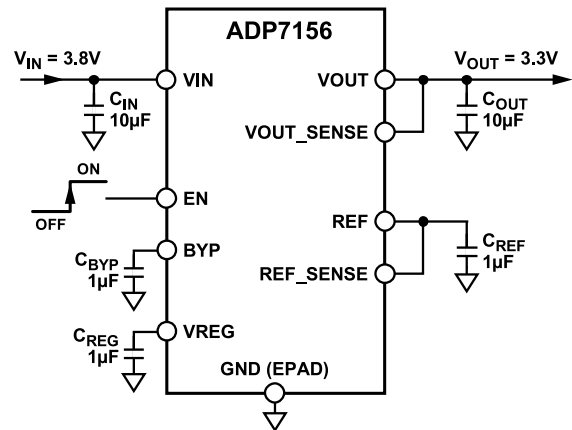

Figure 1.

001

for applications requiring up to 1.2 A of output current in a small, low profile footprint.

Table 1. Related Devices

Model	Input Voltage	Output Current	Fixed/Adj <sup>1</sup>	Package
ADP7158, ADP7159	2.3 V to 5.5 V	2 A	Fixed/Adj	10-lead LFCSP/8-lead SOIC
ADP7157	2.3 V to 5.5 V	1.2 A	Fixed/Adj	10-lead LFCSP/8-lead SOIC
ADM7150, ADM7151	4.5 V to 16 V	800 mA	Fixed/Adj	8-lead LFCSP/8-lead SOIC
ADM7154, ADM7155	2.3 V to 5.5 V	600 mA	Fixed/Adj	8-lead LFCSP/8-lead SOIC
ADM7160	2.2 V to 5.5 V	200 mA	Fixed	6-lead LFCSP/5-lead TSOT

<sup>1</sup> Adj means adjustable.

Rev. D

DOCUMENT FEEDBACK

TECHNICAL SUPPORT

Information furnished by Analog Devices is believed to be accurate and reliable "as is". However, no responsibility is assumed by Analog Devices for its use, nor for any infringements of patents or other rights of third parties that may result from its use. Specifications subject to change without notice. No license is granted by implication or otherwise under any patent or patent rights of Analog Devices. Trademarks and registered trademarks are the property of their respective owners.

**TABLE OF CONTENTS**

Features.....	1	Design Tools.....	14
Applications.....	1	Capacitor Selection.....	14
Typical Application Circuit.....	1	Undervoltage Lockout (UVLO).....	15
General Description.....	1	Programmable Precision Enable.....	15
Specifications.....	3	Start-Up Time.....	16
Input and Output Capacitors, Recommended Specifications.....	4	REF, BYP, and VREG Pins.....	17
Absolute Maximum Ratings.....	5	Current-Limit and Thermal Shutdown.....	17
Thermal Data.....	5	Thermal Considerations.....	17
Thermal Resistance.....	5	Printed Circuit Board (PCB) Layout Considerations.....	20
ESD Caution.....	5	Outline Dimensions.....	21
Pin Configurations and Function Descriptions.....	6	Ordering Guide.....	21
Typical Performance Characteristics.....	7	Output Voltage Options.....	22
Theory of Operation.....	13	Evaluation Boards.....	22
Applications Information.....	14	Automotive Products.....	22

**REVISION HISTORY****5/2023—Rev. C to Rev. D**

Changes to Features Section.....	1
Changes to Dropout Voltage Parameter, Table 2.....	3
Updated Outline Dimensions.....	21
Changes to Ordering Guide.....	21
Changes to Output Voltage Options Section.....	22
Added Automotive Products Section.....	22

**10/2022—Rev. B to Rev. C**

Changes to Features Section.....	1
Deleted Figure 2; Renumbered Sequentially.....	1
Changed ADIsimPOWER Design Tool Section to Design Tools Section.....	14
Changes to Design Tools Section.....	14
Added Output Voltage Options Section.....	22

## SPECIFICATIONS

$V_{IN} = V_{OUT} + 0.5\text{ V}$  or  $2.3\text{ V}$ , whichever is greater;  $V_{EN} = V_{IN}$ ;  $I_{LOAD} = 10\text{ mA}$ ;  $C_{IN} = C_{OUT} = 10\text{ }\mu\text{F}$ ;  $C_{REG} = C_{REF} = C_{BYP} = 1\text{ }\mu\text{F}$ ;  $T_A = 25^\circ\text{C}$  for typical specifications;  $T_A = -40^\circ\text{C}$  to  $+125^\circ\text{C}$  for minimum/maximum specifications, unless otherwise noted.

Table 2.

Parameter	Symbol	Test Conditions/Comments	Min	Typ	Max	Unit
INPUT VOLTAGE RANGE	$V_{IN}$		2.3		5.5	V
LOAD CURRENT	$I_{LOAD}$				1.2	A
OPERATING SUPPLY CURRENT	$I_{GND}$	$I_{LOAD} = 0\text{ }\mu\text{A}$ $I_{LOAD} = 1.2\text{ A}$		4.0 7.0	8.0 12.0	mA mA
SHUTDOWN CURRENT	$I_{IN\_SD}$	EN = GND		0.2	4	$\mu\text{A}$
NOISE <sup>1</sup>		$V_{OUT} = 1.2\text{ V}$ to $3.3\text{ V}$				
Output Noise	$OUT_{NOISE}$	10 Hz to 100 kHz		1.6		$\mu\text{V rms}$
Noise Spectral Density	$OUT_{NSD}$	100 Hz to 100 kHz 10 kHz to 1 MHz		0.9 1.7		$\mu\text{V rms}$ $\text{nV}/\sqrt{\text{Hz}}$
POWER SUPPLY REJECTION RATIO <sup>1</sup>	PSRR	1 kHz to 100 kHz, $V_{IN} = 4.0\text{ V}$ , $V_{OUT} = 3.3\text{ V}$ , $I_{LOAD} = 1.2\text{ A}$ 1 MHz, $V_{IN} = 4.0\text{ V}$ , $V_{OUT} = 3.3\text{ V}$ , $I_{LOAD} = 1.2\text{ A}$ 1 kHz to 100 kHz, $V_{IN} = 2.6\text{ V}$ , $V_{OUT} = 1.8\text{ V}$ , $I_{LOAD} = 1.2\text{ A}$ 1 MHz, $V_{IN} = 2.6\text{ V}$ , $V_{OUT} = 1.8\text{ V}$ , $I_{LOAD} = 1.2\text{ A}$		80 60 80 60		dB dB dB dB
OUTPUT VOLTAGE ACCURACY						
Output Voltage <sup>2</sup>	$V_{OUT}$		1.2		3.3	V
Initial Accuracy		$I_{LOAD} = 10\text{ mA}$ , $T_A = 25^\circ\text{C}$ $10\text{ mA} < I_{LOAD} < 1.2\text{ A}$ , $T_A = 25^\circ\text{C}$ $10\text{ mA} < I_{LOAD} < 1.2\text{ A}$ , $T_A = -40^\circ\text{C}$ to $+125^\circ\text{C}$	-0.6 -1.0 -1.5		+0.6 +1.0 +1.5	% % %
REGULATION						
Line	$\Delta V_{OUT}/\Delta V_{IN}$	$V_{IN} = V_{OUT} + 0.5\text{ V}$ or $2.3\text{ V}$ , whichever is greater to $5.5\text{ V}$	-0.1		+0.1	%/V
Load <sup>3</sup>	$\Delta V_{OUT}/\Delta I_{OUT}$	$I_{OUT} = 10\text{ mA}$ to $1.2\text{ A}$			0.3	%/A
CURRENT-LIMIT THRESHOLD <sup>4</sup>	$I_{LIMIT}$			22		mA
REF				1.4	1.8	A
VOUT					2.4	A
DROPOUT VOLTAGE <sup>5</sup>	$V_{DROPOUT}$	$I_{OUT} = 600\text{ mA}$ , $V_{OUT} = 3.3\text{ V}$ W grade, $I_{OUT} = 600\text{ mA}$ , $V_{OUT} = 3.3\text{ V}$ $I_{OUT} = 1.2\text{ A}$ , $V_{OUT} = 3.3\text{ V}$		60 60 120	80 85 170	mV mV mV
PULL-DOWN RESISTANCE		EN = 0 V, $V_{IN} = 5.5\text{ V}$				
VOUT	$V_{OUT\_PULL}$	$V_{OUT} = 1\text{ V}$		650		$\Omega$
VREG	$V_{REG\_PULL}$	$V_{REG} = 1\text{ V}$		31		k $\Omega$
REF	$V_{REF\_PULL}$	$V_{REF} = 1\text{ V}$		850		$\Omega$
BYP	$V_{BYP\_PULL}$	$V_{BYP} = 1\text{ V}$		650		$\Omega$
START-UP TIME <sup>1, 6</sup>		$V_{OUT} = 3.3\text{ V}$				
VOUT	$t_{START-UP}$			1.2		ms
VREG	$t_{REG\_START-UP}$			0.6		ms
REF	$t_{REF\_START-UP}$			0.5		ms
THERMAL SHUTDOWN <sup>1</sup>						
Threshold	$TS_{SD}$	$T_J$ rising		150		$^\circ\text{C}$
Hysteresis	$TS_{SD\_HYS}$			15		$^\circ\text{C}$
UNDERVOLTAGE THRESHOLDS						
Input Voltage						
Rising	$UVLO_{RISE}$			2.22	2.29	V
Falling	$UVLO_{FALL}$		1.95	2.02		V
Hysteresis	$UVLO_{HYS}$			200		mV

## SPECIFICATIONS

Table 2. (Continued)

Parameter	Symbol	Test Conditions/Comments	Min	Typ	Max	Unit
VREG UVLO THRESHOLDS <sup>7</sup>						
Rising	VREGUVLO <sub>RISE</sub>				1.94	V
Falling	VREGUVLO <sub>FALL</sub>		1.60			V
Hysteresis	VREGUVLO <sub>HYS</sub>			185		mV
EN INPUT PRECISION		2.3 V ≤ V <sub>IN</sub> ≤ 5.5 V				
EN Input						
Logic High	V <sub>EN_HIGH</sub>		1.13	1.22	1.31	V
Logic Low	V <sub>EN_LOW</sub>		1.05	1.13	1.22	V
Logic Hysteresis	V <sub>EN_HYS</sub>			90		mV
LEAKAGE CURRENT						
REF_SENSE	I <sub>REF_SENSE_LKG</sub>			10		nA
EN	I <sub>EN_LKG</sub>	EN = V <sub>IN</sub> or GND		0.01	1	μA

<sup>1</sup> Guaranteed by characterization; not production tested.

<sup>2</sup> The ADP7156 is available in 16 standard voltages between 1.2 V and 3.3 V, including 1.2 V, 1.3 V, 1.5 V, 1.6 V, 1.8 V, 2.0 V, 2.2 V, 2.5 V, 2.6 V, 2.7 V, 2.8 V, 2.9 V, 3.0 V, 3.1 V, 3.2 V, and 3.3 V.

<sup>3</sup> Based on an endpoint calculation using 10 mA and 1.2 A loads.

<sup>4</sup> Current-limit threshold is defined as the current at which the output voltage drops to 90% of the specified typical value. For example, the current limit for a 3.0 V output voltage is defined as the current that causes the output voltage to drop to 90% of 3.0 V, or 2.7 V.

<sup>5</sup> Dropout voltage is defined as the input to output voltage differential when the input voltage is set to the nominal output voltage. Dropout voltage applies only for output voltages greater than 2.3 V.

<sup>6</sup> Start-up time is defined as the time between the rising edge of VEN to VOUT, VREG, or VREF being at 90% of its nominal value.

<sup>7</sup> The output voltage is disabled until the VREG UVLO rise threshold is crossed. The VREG output is disabled until the input voltage UVLO rising threshold is crossed.

## INPUT AND OUTPUT CAPACITORS, RECOMMENDED SPECIFICATIONS

Table 3.

Parameter	Symbol	Test Conditions/Comments	Min	Typ	Max	Unit
MINIMUM CAPACITANCE		T <sub>A</sub> = -40°C to +125°C				
Input <sup>1</sup>	C <sub>IN</sub>		7.0	10.0		μF
Regulator	C <sub>REG</sub>		0.7	1.0		μF
Output <sup>1</sup>	C <sub>OUT</sub>		7.0	10.0		μF
Bypass	C <sub>BYP</sub>		0.1	1.0		μF
Reference	C <sub>REF</sub>		0.7	1.0		μF
CAPACITOR EFFECTIVE SERIES RESISTANCE (ESR)		T <sub>A</sub> = -40°C to +125°C				
C <sub>OUT</sub> , C <sub>IN</sub>	R <sub>ESR</sub>				0.1	Ω
C <sub>REG</sub> , C <sub>REF</sub>	R <sub>ESR</sub>				0.2	Ω
C <sub>BYP</sub>	R <sub>ESR</sub>				2.0	Ω

<sup>1</sup> The minimum input and output capacitance must be greater than 7.0 μF over the full range of operating conditions. The full range of operating conditions in the application must be considered during device selection to ensure that the minimum capacitance specification is met. X7R and X5R type capacitors are recommended; Y5V and Z5U capacitors are not recommended for use with any low dropout regulator.

## ABSOLUTE MAXIMUM RATINGS

Table 4.

Parameter	Rating
VIN to Ground	-0.3 V to +7 V
VREG to Ground	-0.3 V to $V_{IN}$ , or +4 V (whichever is less)
VOUT to Ground	-0.3 V to $V_{REG}$ , or +4 V (whichever is less)
VOUT_SENSE to Ground	-0.3 V to $V_{REG}$ , or +4 V (whichever is less)
VOUT to VOUT_SENSE	$\pm 0.3$ V
BYP to VOUT	$\pm 0.3$ V
EN to Ground	-0.3 V to +7 V
BYP to Ground	-0.3 V to $V_{REG}$ , or +4 V (whichever is less)
REF to Ground	-0.3 V to $V_{REG}$ , or +4 V (whichever is less)
REF_SENSE to Ground	-0.3 V to +4 V
Storage Temperature Range	-65°C to +150°C
Operational Junction Temperature Range	-40°C to +125°C
Soldering Conditions	JEDEC J-STD-020

Stresses at or above those listed under Absolute Maximum Ratings may cause permanent damage to the product. This is a stress rating only; functional operation of the product at these or any other conditions above those indicated in the operational section of this specification is not implied. Operation beyond the maximum operating conditions for extended periods may affect product reliability.

## THERMAL DATA

Absolute maximum ratings apply individually only, not in combination. The ADP7156 can be damaged when the junction temperature limits are exceeded. Monitoring ambient temperature does not guarantee that  $T_J$  is within the specified temperature limits. In applications with high power dissipation and poor thermal resistance, the maximum ambient temperature may need to be derated.

In applications with moderate power dissipation and low printed circuit board (PCB) thermal resistance, the maximum ambient temperature can exceed the maximum limit as long as the junction temperature is within specification limits. The junction temperature ( $T_J$ ) of the device is dependent on the ambient temperature ( $T_A$ ), the power dissipation of the device ( $P_D$ ), and the junction to ambient thermal resistance of the package ( $\theta_{JA}$ ).

Calculate the maximum junction temperature ( $T_J$ ) from the ambient temperature ( $T_A$ ) and power dissipation ( $P_D$ ) using the following formula:

$$T_J = T_A + (P_D \times \theta_{JA})$$

Junction to ambient thermal resistance ( $\theta_{JA}$ ) of the package is based on modeling and calculation using a 4-layer board. The junction to ambient thermal resistance is highly dependent on the application and board layout. In applications where high maximum power dissipation exists, close attention to thermal board design is

required. The value of  $\theta_{JA}$  may vary, depending on PCB material, layout, and environmental conditions. The specified values of  $\theta_{JA}$  are based on a 4-layer, 4 in.  $\times$  3 in. circuit board. See JESD51-7 and JESD51-9 for detailed information on the board construction.

$\Psi_{JB}$  is the junction to board thermal characterization parameter with units of °C/W.  $\Psi_{JB}$  of the package is based on modeling and calculation using a 4-layer board. JESD51-12, *Guidelines for Reporting and Using Electronic Package Thermal Information*, states that thermal characterization parameters are not the same as thermal resistances.  $\Psi_{JB}$  measures the component power flowing through multiple thermal paths rather than a single path as in thermal resistance,  $\theta_{JB}$ . Therefore,  $\Psi_{JB}$  thermal paths include convection from the top of the package as well as radiation from the package, factors that make  $\Psi_{JB}$  more useful in real-world applications. Maximum junction temperature ( $T_J$ ) is calculated from the board temperature ( $T_B$ ) and power dissipation ( $P_D$ ) using the following formula:

$$T_J = T_B + (P_D \times \Psi_{JB})$$

See JESD51-8 and JESD51-12 for more detailed information about  $\Psi_{JB}$ .

## THERMAL RESISTANCE

$\theta_{JA}$ ,  $\theta_{JC}$ , and  $\Psi_{JB}$  are specified for the worst case conditions, that is, a device soldered in a circuit board for surface-mount packages.

Table 5. Thermal Resistance

Package Type	$\theta_{JA}$	$\theta_{JC}$	$\Psi_{JB}$	Unit
10-Lead LFCSP	53.8	15.6	29.1	°C/W
8-Lead SOIC	50.4	42.3	30.1	°C/W

## ESD CAUTION



**ESD (electrostatic discharge) sensitive device.** Charged devices and circuit boards can discharge without detection. Although this product features patented or proprietary protection circuitry, damage may occur on devices subjected to high energy ESD. Therefore, proper ESD precautions should be taken to avoid performance degradation or loss of functionality.

PIN CONFIGURATIONS AND FUNCTION DESCRIPTIONS

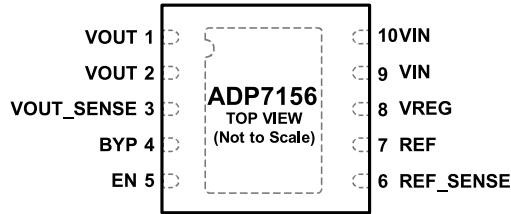

NOTES

1. THE EXPOSED PAD IS LOCATED ON THE BOTTOM OF THE PACKAGE. THE EXPOSED PAD ENHANCES THERMAL PERFORMANCE, AND IT IS ELECTRICALLY CONNECTED TO GROUND INSIDE THE PACKAGE. CONNECT THE EXPOSED PAD TO THE GROUND PLANE ON THE BOARD TO ENSURE PROPER OPERATION.

003

Figure 2. 10-Lead LFCSP Pin Configuration

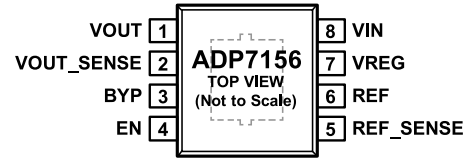

NOTES

1. THE EXPOSED PAD IS LOCATED ON THE BOTTOM OF THE PACKAGE. THE EXPOSED PAD ENHANCES THERMAL PERFORMANCE, AND IT IS ELECTRICALLY CONNECTED TO GROUND INSIDE THE PACKAGE. CONNECT THE EXPOSED PAD TO THE GROUND PLANE ON THE BOARD TO ENSURE PROPER OPERATION.

004

Figure 3. 8-Lead SOIC Pin Configuration

Table 6. Pin Function Descriptions

Pin No.		Mnemonic	Description
LFCSP	SOIC		
1, 2	1	VOUT	Regulated Output Voltage. Bypass VOUT to ground with a 10 $\mu$ F or greater capacitor.
3	2	VOUT_SENSE	Output Sense. VOUT_SENSE is internally connected to VOUT with a 10 $\Omega$ resistor. Connect VOUT_SENSE as close to the load as possible.
4	3	BYP	Low Noise Bypass Capacitor. Connect a 1 $\mu$ F capacitor from the BYP pin to ground to reduce noise. Do not connect a load to this pin.
5	4	EN	Enable. Drive EN high to turn on the regulator; drive EN low to turn off the regulator. For automatic startup, connect EN to VIN.
6	5	REF_SENSE	Reference Sense. Connect REF_SENSE to the REF pin. Do not connect REF_SENSE to VOUT or GND.
7	6	REF	Low Noise Reference Voltage Output. Bypass REF to ground with a 1 $\mu$ F or greater capacitor. Short REF_SENSE to REF for fixed output voltages. Do not connect a load to this pin.
8	7	VREG	Regulated Input Supply Voltage to Low Dropout (LDO) Amplifier. Bypass VREG to ground with a 1 $\mu$ F or greater capacitor.
9, 10	8	VIN	Regulator Input Supply Voltage. Bypass VIN to ground with a 10 $\mu$ F or greater capacitor.
		EP	Exposed Pad. The exposed pad is located on the bottom of the package. The exposed pad enhances thermal performance, and it is electrically connected to ground inside the package. Connect the exposed pad to the ground plane on the board to ensure proper operation.

TYPICAL PERFORMANCE CHARACTERISTICS

$V_{IN} = V_{OUT} + 0.5\text{ V}$  or  $2.3\text{ V}$ , whichever is greater;  $V_{EN} = V_{IN}$ ;  $I_{LOAD} = 10\text{ mA}$ ;  $C_{IN} = C_{OUT} = 10\text{ }\mu\text{F}$ ;  $C_{REG} = C_{REF} = C_{BYP} = 1\text{ }\mu\text{F}$ ;  $T_A = 25^\circ\text{C}$  unless otherwise noted.

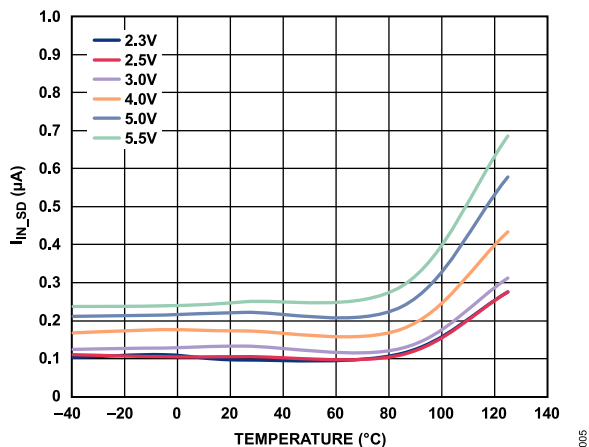

Figure 4. Shutdown Current ( $I_{IN\_SD}$ ) vs. Temperature at Various Input Voltages ( $V_{IN}$ ),  $V_{OUT} = 1.8\text{ V}$

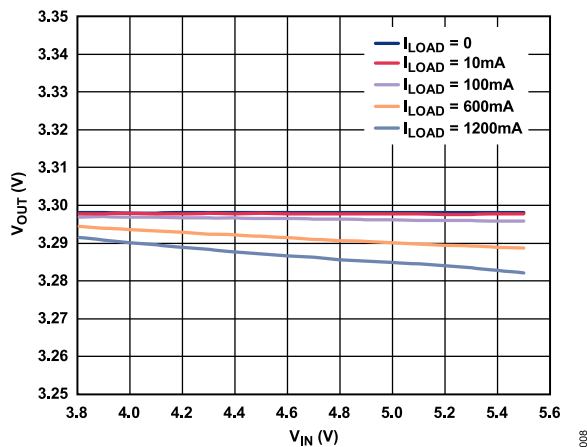

Figure 7. Output Voltage ( $V_{OUT}$ ) vs. Input Voltage ( $V_{IN}$ ) at Various Loads,  $V_{OUT} = 3.3\text{ V}$

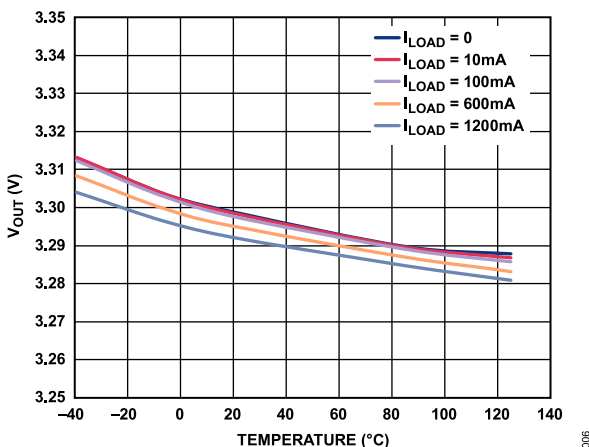

Figure 5. Output Voltage ( $V_{OUT}$ ) vs. Temperature at Various Loads,  $V_{OUT} = 3.3\text{ V}$

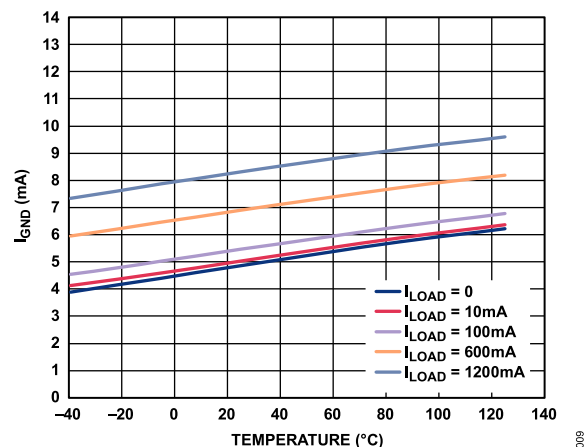

Figure 8. Ground Current ( $I_{GND}$ ) vs. Temperature at Various Loads,  $V_{OUT} = 3.3\text{ V}$

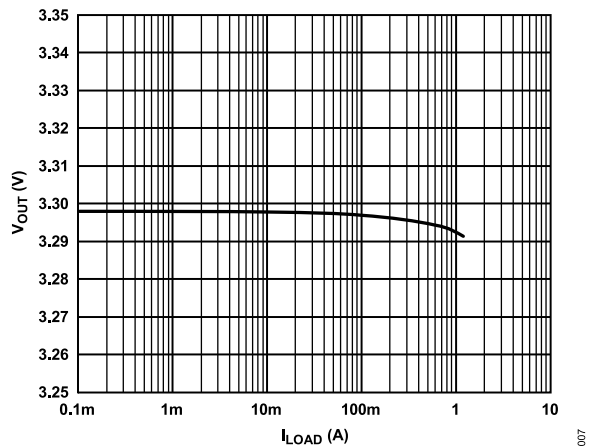

Figure 6. Output Voltage ( $V_{OUT}$ ) vs. Load Current ( $I_{LOAD}$ ),  $V_{OUT} = 3.3\text{ V}$

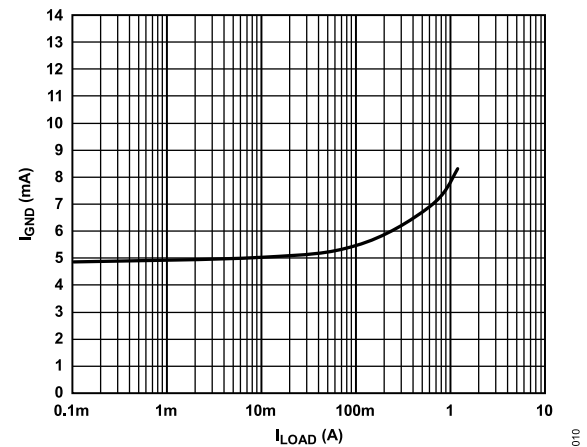

Figure 9. Ground Current ( $I_{GND}$ ) vs. Load Current ( $I_{LOAD}$ ),  $V_{OUT} = 3.3\text{ V}$

TYPICAL PERFORMANCE CHARACTERISTICS

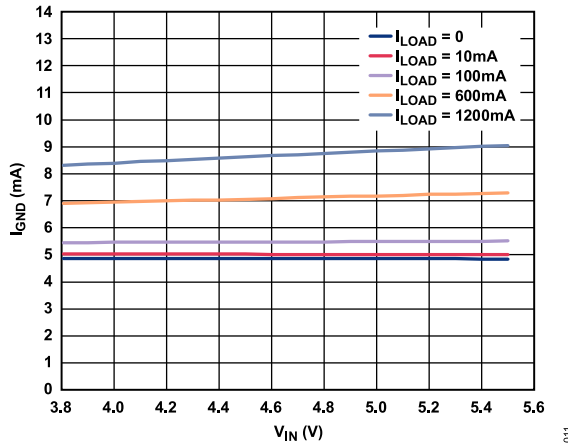

Figure 10. Ground Current ( $I_{GND}$ ) vs. Input Voltage ( $V_{IN}$ ) at Various Loads,  $V_{OUT} = 3.3\text{ V}$

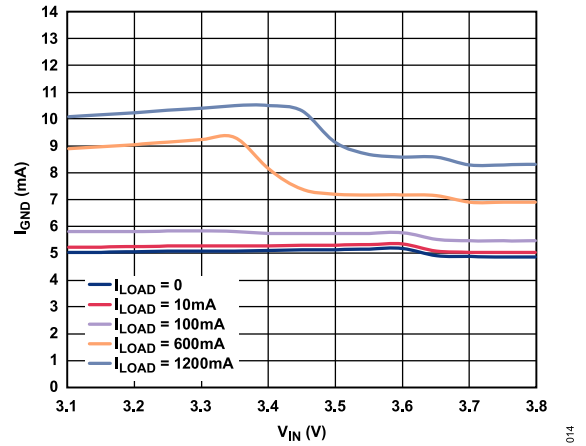

Figure 13. Ground Current ( $I_{GND}$ ) vs. Input Voltage ( $V_{IN}$ ) at Various Loads in Dropout,  $V_{OUT} = 3.3\text{ V}$

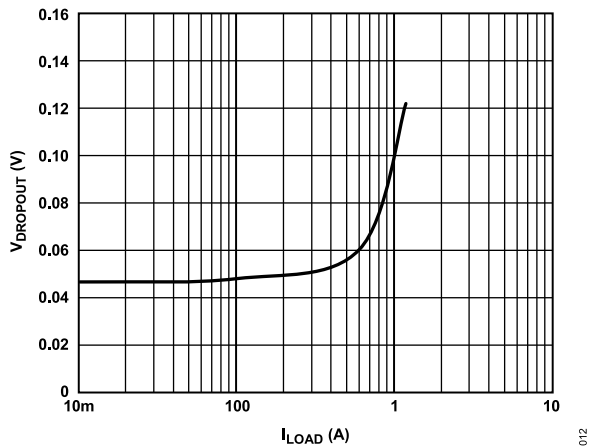

Figure 11. Dropout Voltage ( $V_{DROPOUT}$ ) vs. Load Current ( $I_{LOAD}$ ),  $V_{OUT} = 3.3\text{ V}$

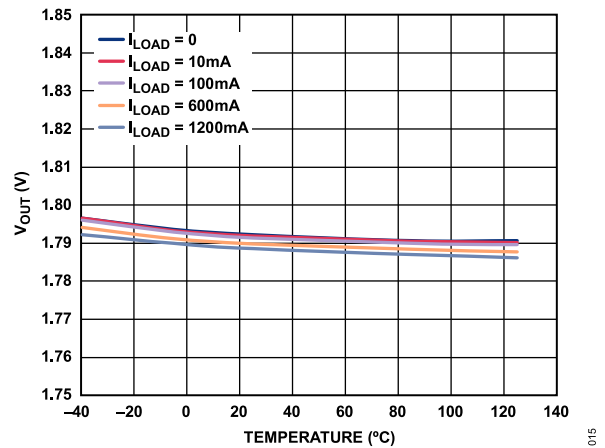

Figure 14. Output Voltage ( $V_{OUT}$ ) vs. Temperature at Various Loads,  $V_{OUT} = 1.8\text{ V}$

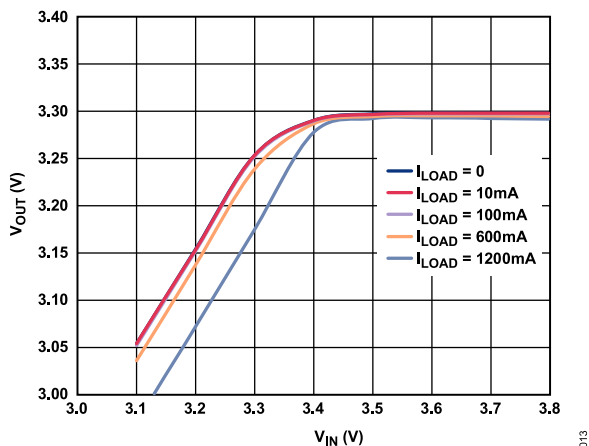

Figure 12. Output Voltage ( $V_{OUT}$ ) vs. Input Voltage ( $V_{IN}$ ) at Various Loads in Dropout,  $V_{OUT} = 3.3\text{ V}$

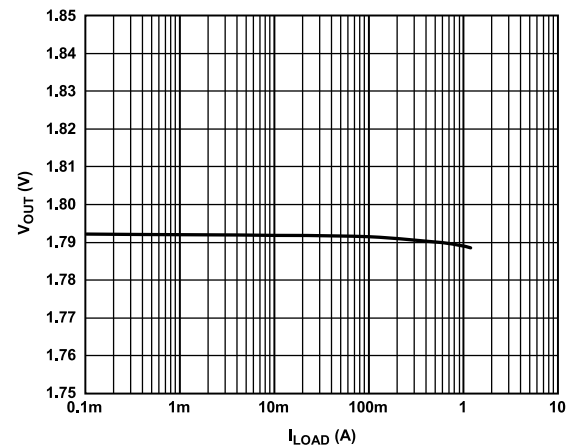

Figure 15. Output Voltage ( $V_{OUT}$ ) vs. Load Current ( $I_{LOAD}$ ),  $V_{OUT} = 1.8\text{ V}$

TYPICAL PERFORMANCE CHARACTERISTICS

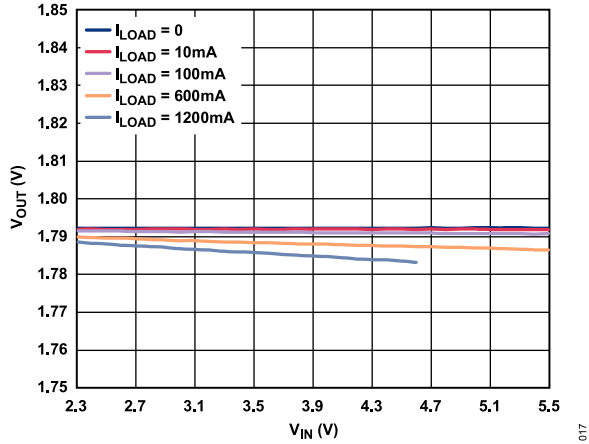

Figure 16. Output Voltage ( $V_{OUT}$ ) vs. Input Voltage ( $V_{IN}$ ) at Various Loads,  $V_{OUT} = 1.8\text{ V}$

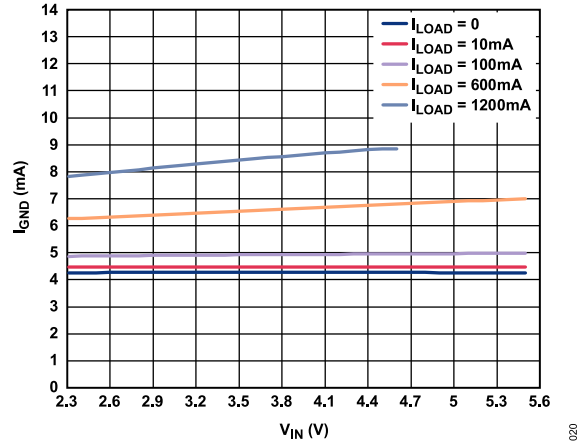

Figure 19. Ground Current ( $I_{GND}$ ) vs. Input Voltage ( $V_{IN}$ ) at Various Loads,  $V_{OUT} = 1.8\text{ V}$

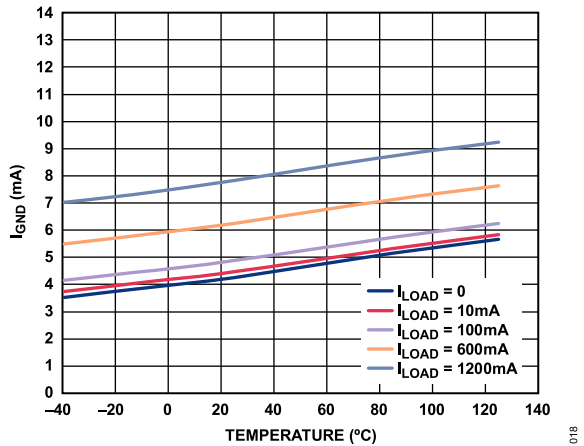

Figure 17. Ground Current ( $I_{GND}$ ) vs. Temperature at Various Loads,  $V_{OUT} = 1.8\text{ V}$

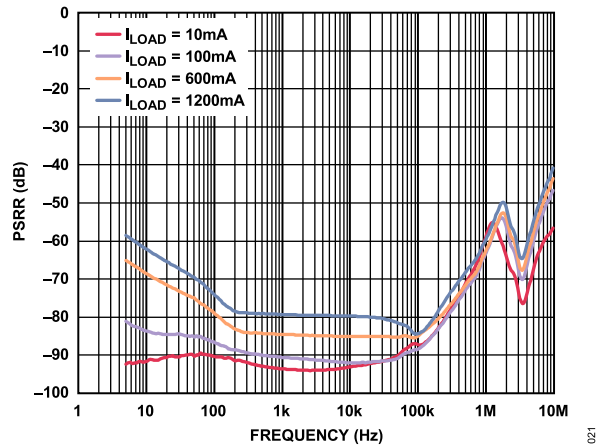

Figure 20. Power Supply Rejection Ratio (PSRR) vs. Frequency at Various Loads,  $V_{OUT} = 3.3\text{ V}$ ,  $V_{IN} = 4.0\text{ V}$

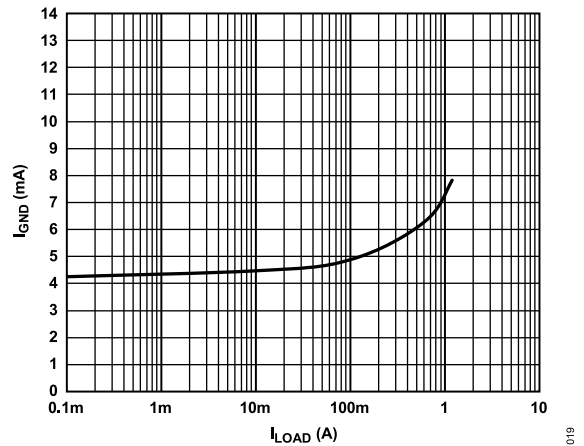

Figure 18. Ground Current ( $I_{GND}$ ) vs. Load Current ( $I_{LOAD}$ ),  $V_{OUT} = 1.8\text{ V}$

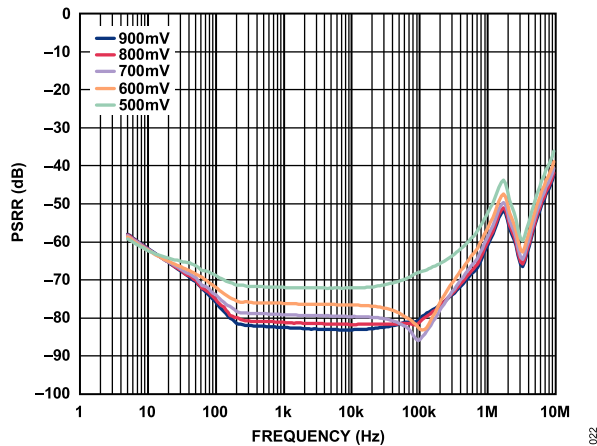

Figure 21. Power Supply Rejection Ratio (PSRR) vs. Frequency at Various Headroom Voltages,  $V_{OUT} = 3.3\text{ V}$ ,  $1.2\text{ A Load}$

TYPICAL PERFORMANCE CHARACTERISTICS

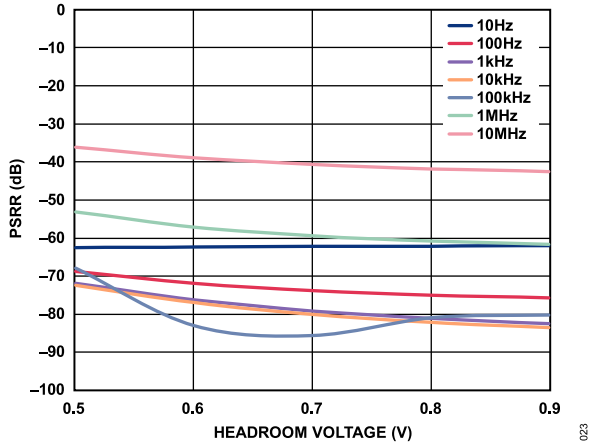

Figure 22. Power Supply Rejection Ratio (PSRR) vs. Headroom Voltage at Various Frequencies,  $V_{OUT} = 3.3\text{ V}$ , 1.2 A Load

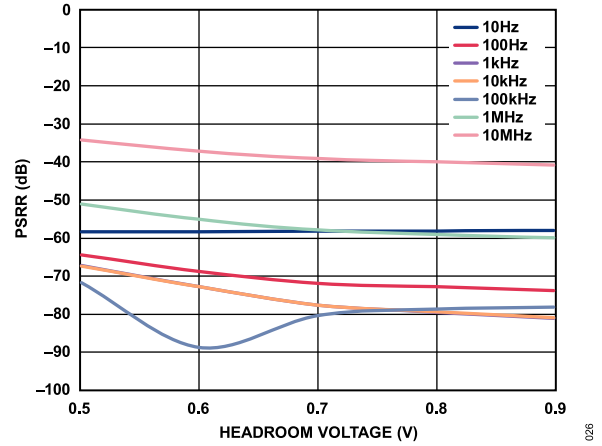

Figure 25. Power Supply Rejection Ratio (PSRR) vs. Headroom Voltage at Various Frequencies,  $V_{OUT} = 1.8\text{ V}$ , 1.2 A Load

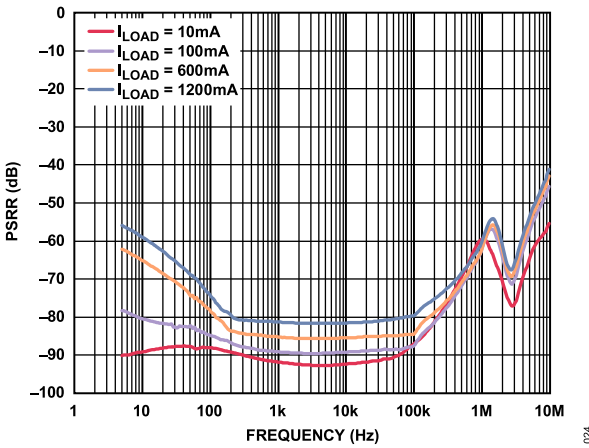

Figure 23. Power Supply Rejection Ratio (PSRR) vs. Frequency at Various Loads,  $V_{OUT} = 1.8\text{ V}$ ,  $V_{IN} = 2.6\text{ V}$

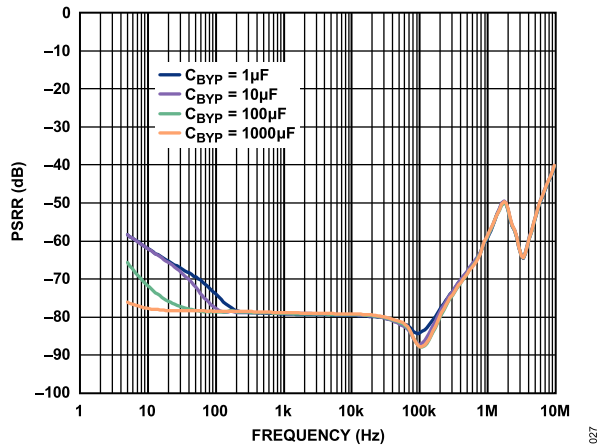

Figure 26. Power Supply Rejection Ratio (PSRR) vs. Frequency at Various  $C_{BYP}$  Values,  $V_{OUT} = 3.3\text{ V}$ ,  $V_{IN} = 4.0\text{ V}$ , 1.2 A Load

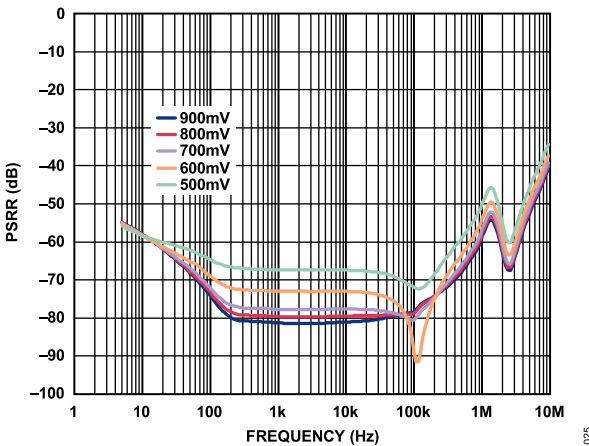

Figure 24. Power Supply Rejection Ratio (PSRR) vs. Frequency at Various Headroom Voltages,  $V_{OUT} = 1.8\text{ V}$ , 1.2 A Load

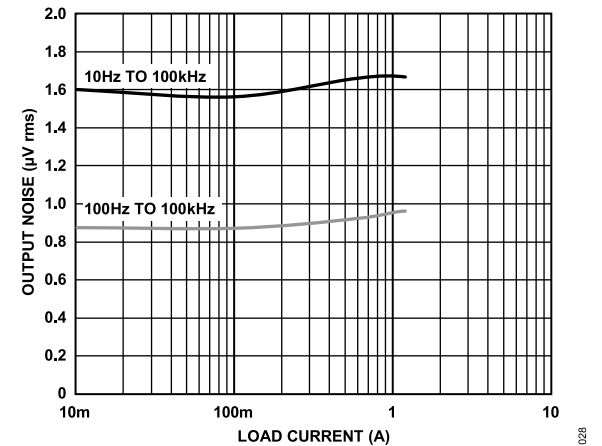

Figure 27. RMS Output Noise vs. Load Current

TYPICAL PERFORMANCE CHARACTERISTICS

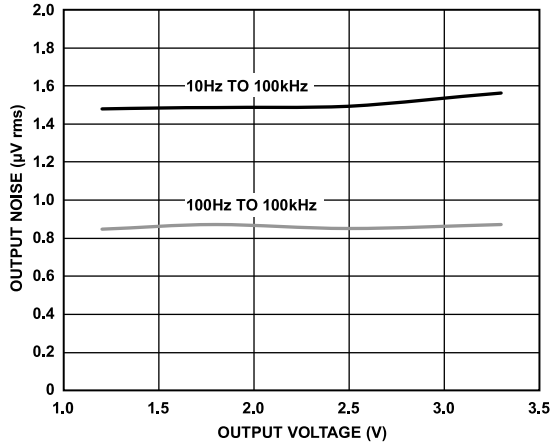

Figure 28. RMS Output Noise vs. Output Voltage

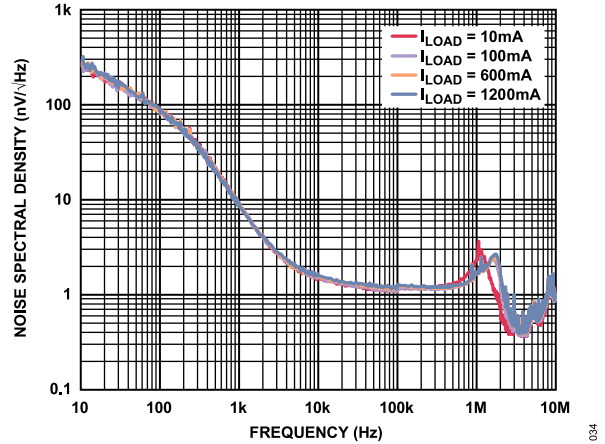

Figure 31. Output Noise Spectral Density vs. Frequency at Various Loads, 10 Hz to 10 MHz

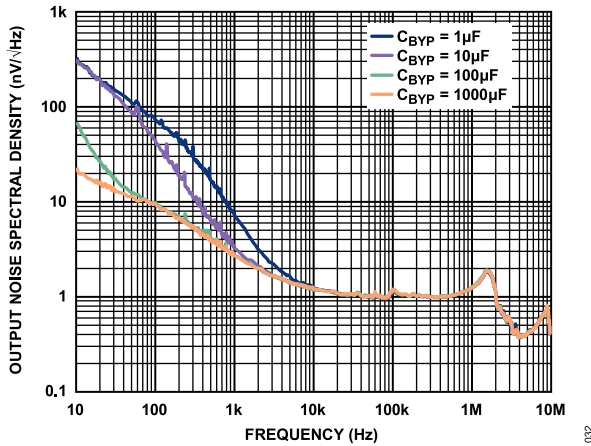

Figure 29. Noise Spectral Density vs. Frequency at Various Values of  $C_{BYP}$

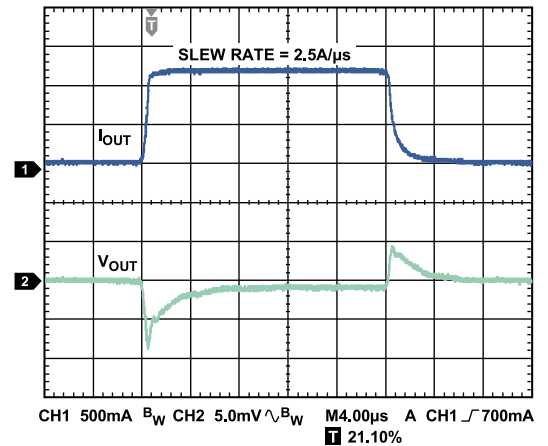

Figure 32. Load Transient Response,  $I_{LOAD} = 100\text{ mA}$  to  $1.2\text{ A}$ ,  $V_{OUT} = 3.3\text{ V}$ ,  $V_{IN} = 4.0\text{ V}$ , Channel 1 =  $I_{OUT}$ , Channel 2 =  $V_{OUT}$

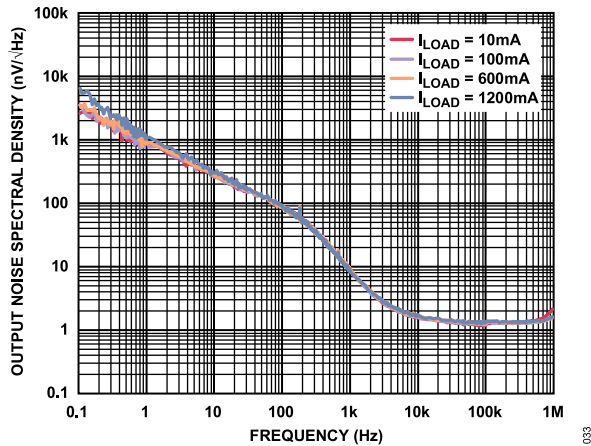

Figure 30. Output Noise Spectral Density vs. Frequency at Various Loads, 0.1 Hz to 1 MHz

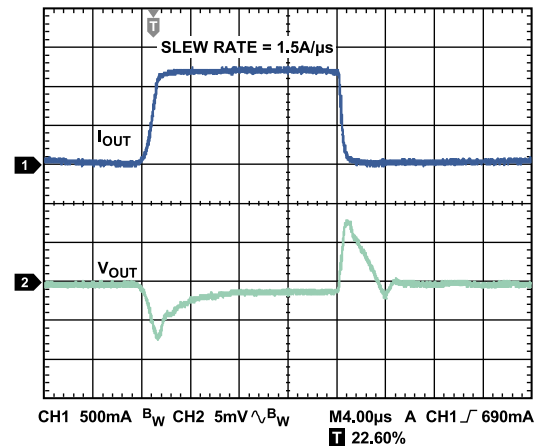

Figure 33. Load Transient Response,  $I_{LOAD} = 100\text{ mA}$  to  $1.2\text{ A}$ ,  $V_{OUT} = 3.3\text{ V}$ ,  $V_{IN} = 4.0\text{ V}$ ,  $C_{OUT} = 22\text{ }\mu\text{F}$ , Channel 1 =  $I_{OUT}$ , Channel 2 =  $V_{OUT}$

TYPICAL PERFORMANCE CHARACTERISTICS

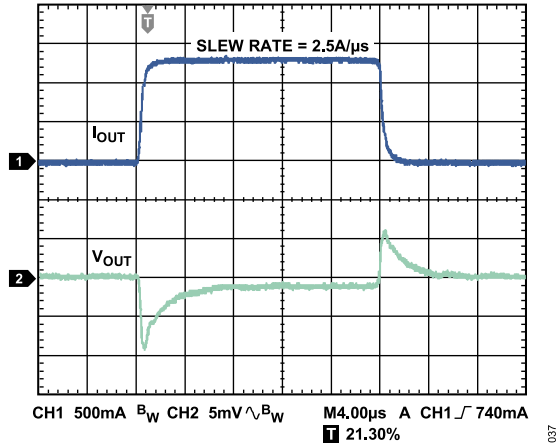

Figure 34. Load Transient Response,  $I_{LOAD} = 100\text{ mA}$  to  $1.2\text{ A}$ ,  $V_{OUT} = 1.8\text{ V}$ ,  $V_{IN} = 2.5\text{ V}$ , Channel 1 =  $I_{OUT}$ , Channel 2 =  $V_{OUT}$

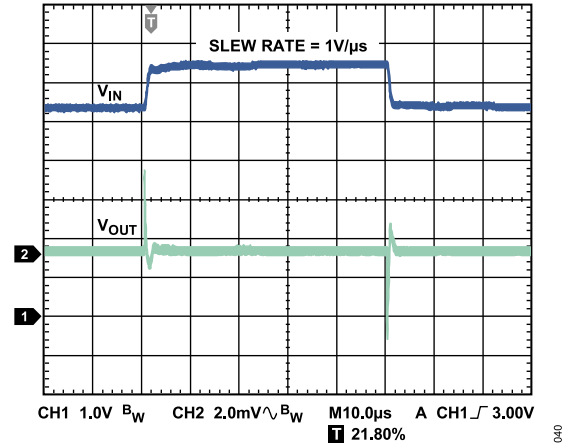

Figure 37. Line Transient Response,  $1\text{ V}$  Input Step,  $I_{LOAD} = 1.2\text{ A}$ ,  $V_{OUT} = 1.8\text{ V}$ ,  $V_{IN} = 2.5\text{ V}$ , Channel 1 =  $V_{IN}$ , Channel 2 =  $V_{OUT}$

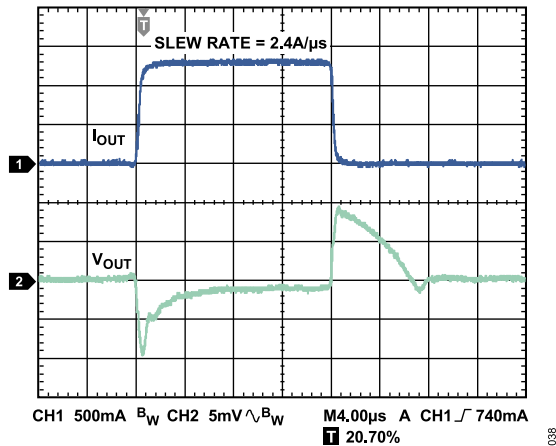

Figure 35. Load Transient Response,  $I_{LOAD} = 100\text{ mA}$  to  $1.2\text{ A}$ ,  $V_{OUT} = 1.8\text{ V}$ ,  $V_{IN} = 2.5\text{ V}$ ,  $C_{OUT} = 22\text{ }\mu\text{F}$ , Channel 1 =  $I_{OUT}$ , Channel 2 =  $V_{OUT}$

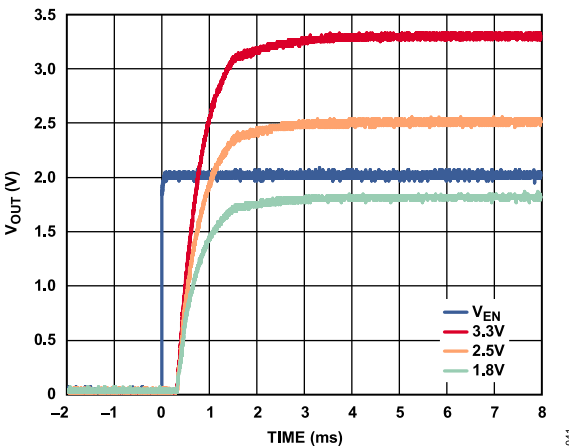

Figure 38.  $V_{OUT}$  Start-Up Time After  $V_{EN}$  Rising, at Various Output Voltages,  $V_{IN} = 5\text{ V}$ ,  $C_{BYP} = 1\text{ }\mu\text{F}$

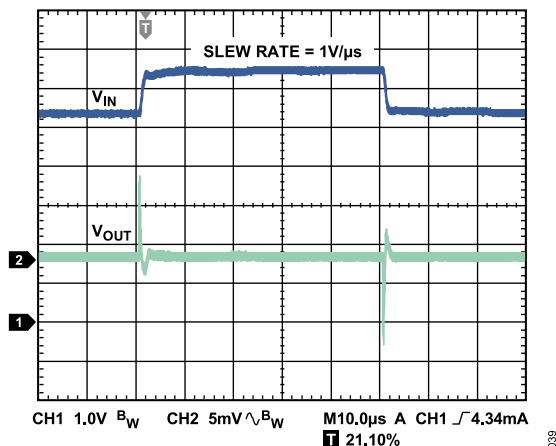

Figure 36. Line Transient Response,  $1\text{ V}$  Input Step,  $I_{LOAD} = 1.2\text{ A}$ ,  $V_{OUT} = 3.3\text{ V}$ ,  $V_{IN} = 3.8\text{ V}$ , Channel 1 =  $V_{IN}$ , Channel 2 =  $V_{OUT}$

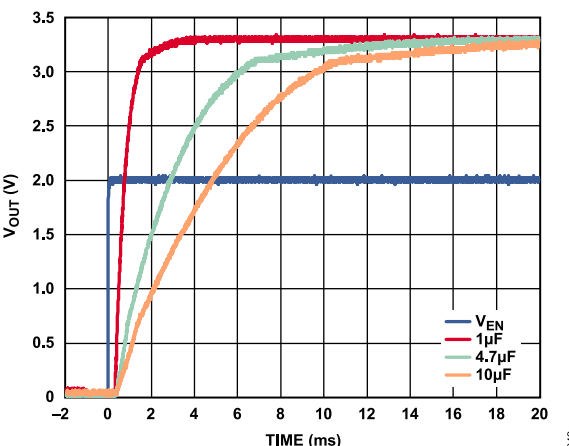

Figure 39.  $V_{OUT}$  Start-Up Time Behavior at Various Values of  $C_{BYP}$ ,  $V_{OUT} = 3.3\text{ V}$

**THEORY OF OPERATION**

The ADP7156 is an ultralow noise, high PSRR linear regulator targeting radio frequency (RF) applications. The input voltage range is 2.3 V to 5.5 V, and it can deliver up to 1.2 A of load current. Typical shutdown current consumption is 0.2  $\mu$ A at room temperature.

Optimized for use with 10  $\mu$ F ceramic capacitors, the ADP7156 provides excellent transient performance.

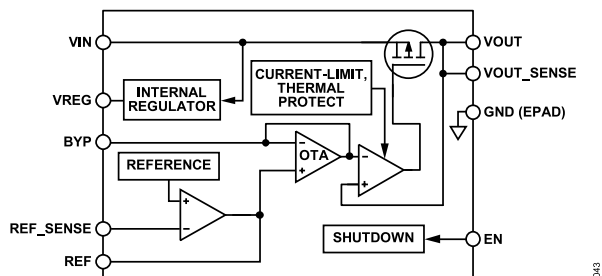

Figure 40. Simplified Internal Block Diagram

Internally, the ADP7156 consists of a reference, an error amplifier, and a P-channel MOSFET pass transistor. The output current is delivered via the PMOS pass device, which is controlled by the error amplifier. The error amplifier compares the reference voltage with the feedback voltage from the output and amplifies the difference. If the feedback voltage is lower than the reference voltage, the gate of the PMOS device is pulled lower, allowing more current to pass and increasing the output voltage. If the feedback voltage is higher than the reference voltage, the gate of the PMOS device is pulled higher, allowing less current to pass and decreasing the output voltage.

By heavily filtering the reference voltage, the ADP7156 can achieve 1.7 nV/ $\sqrt$ Hz typical output noise spectral density from 10 kHz to 1 MHz. Because the error amplifier is always in unity gain, the output noise is independent of the output voltage.

The ADP7156 uses the EN pin to enable and disable the VOUT pin under normal operating conditions. When EN is high, VOUT turns on, and when EN is low, VOUT turns off. For automatic startup, tie EN to VIN.

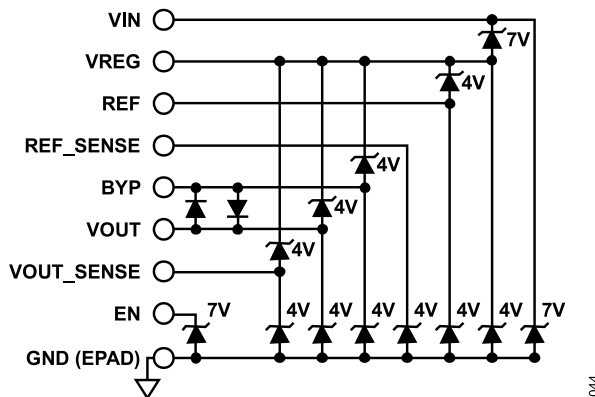

Figure 41. Simplified ESD Protection Block Diagram

The ESD protection devices are shown in the block diagram as Zener diodes (see Figure 41).

## APPLICATIONS INFORMATION

## DESIGN TOOLS

The ADP7156 is supported by the ADIsimPower™, LTpowerCAD®, and LTspice® design tools to produce complete power designs and simulations. For more information on design tools, visit the ADP7156 product page, [www.analog.com/adp7156](http://www.analog.com/adp7156).

## CAPACITOR SELECTION

Multilayer ceramic capacitors (MLCCs) combine small size, low ESR, low ESL, and a wide operating temperature range, making them an ideal choice for bypass capacitors. They are not without faults, however. Depending on the dielectric material, the capacitance can vary dramatically with temperature, dc bias, and ac signal level. Therefore, selecting the proper capacitor results in the best circuit performance.

## Output Capacitor

The ADP7156 is designed for operation with ceramic capacitors but functions with most commonly used capacitors when care is taken with regard to the ESR value. The ESR of the output capacitor affects the stability of the LDO control loop. A minimum of 10  $\mu\text{F}$  capacitance with an ESR of 0.1  $\Omega$  or less is recommended to ensure the stability of the ADP7156. Output capacitance also affects transient response to changes in load current. Using a larger value of output capacitance improves the transient response of the ADP7156 to large changes in load current. Figure 42 shows the transient responses for an output capacitance value of 10  $\mu\text{F}$ .

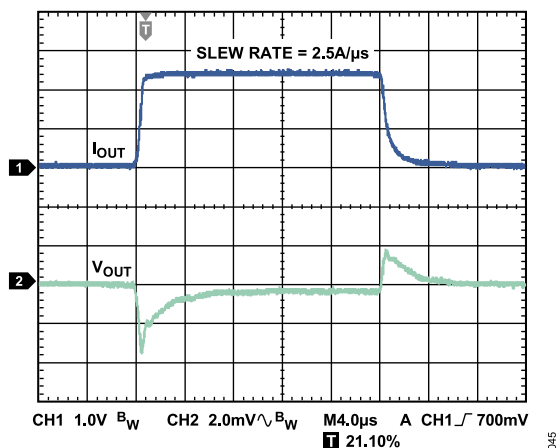

Figure 42. Output Transient Response,  $V_{OUT} = 3.3\text{ V}$ ,  $C_{OUT} = 10\ \mu\text{F}$ , Channel 1 = Load Current, Channel 2 =  $V_{OUT}$

## Input and VREG Capacitor

Connecting a 10  $\mu\text{F}$  capacitor from  $V_{IN}$  to ground reduces the circuit sensitivity to PCB layout, especially when long input traces or high source impedance are encountered.

To maintain the best possible stability and PSRR performance, connect a 1  $\mu\text{F}$  or greater capacitor from VREG to ground.

## REF Capacitor

The REF capacitor,  $C_{REF}$ , is necessary to stabilize the reference amplifier. Connect a 1  $\mu\text{F}$  or greater capacitor between REF and ground.

## BYP Capacitor

The BYP capacitor,  $C_{BYP}$ , is necessary to filter the reference buffer. A 1  $\mu\text{F}$  capacitor is typically connected between BYP and ground. Capacitors as small as 0.1  $\mu\text{F}$  can be used; however, the output noise voltage of the LDO increases as a result.

In addition, the BYP capacitor value can be increased to reduce the noise below 1 kHz at the expense of increasing the start-up time of the LDO regulator. Very large values of  $C_{BYP}$  significantly reduce the noise below 10 Hz. Tantalum capacitors are recommended for capacitors larger than approximately 33  $\mu\text{F}$  because solid tantalum capacitors are less prone to microphonic noise issues. A 1  $\mu\text{F}$  ceramic capacitor in parallel with the larger tantalum capacitor is recommended to ensure good noise performance at higher frequencies.

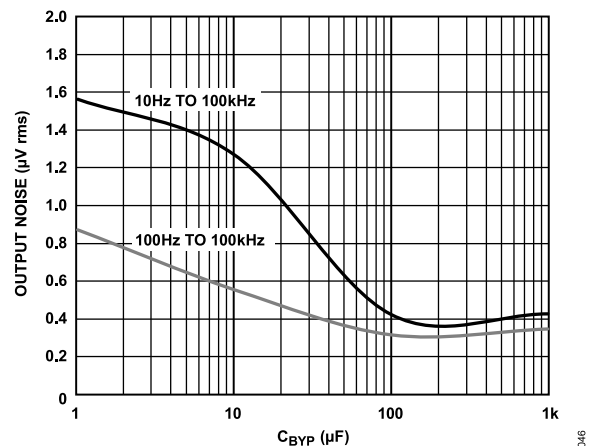

Figure 43. RMS Output Noise vs. Bypass Capacitance ( $C_{BYP}$ )

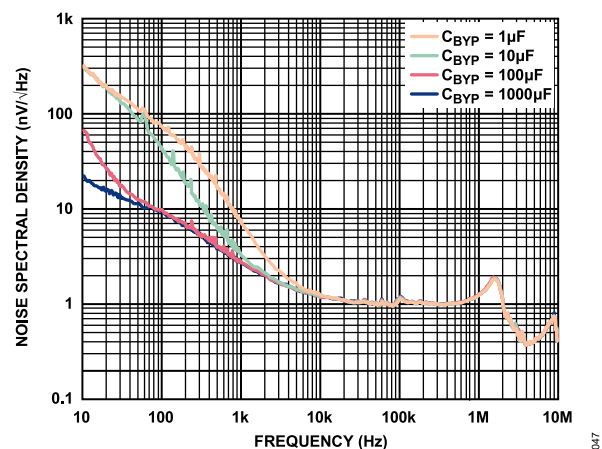

Figure 44. Noise Spectral Density vs. Frequency at Various  $C_{BYP}$  Values

## APPLICATIONS INFORMATION

### Capacitor Properties

Any good quality ceramic capacitors can be used with the ADP7156 if they meet the minimum capacitance and maximum ESR requirements. Ceramic capacitors are manufactured with a variety of dielectrics, each with different behavior over temperature and applied voltage. Capacitors must have a dielectric adequate to ensure the minimum capacitance over the necessary temperature range and dc bias conditions. X5R or X7R dielectrics with a voltage rating of 6.3 V to 50 V are recommended. However, Y5V and Z5U dielectrics are not recommended because of their poor temperature and dc bias characteristics.

Figure 45 depicts the capacitance vs. dc bias voltage of a 1206, 10  $\mu\text{F}$ , 10 V, X5R capacitor. The voltage stability of a capacitor is strongly influenced by the capacitor size and voltage rating. In general, a capacitor in a larger package or higher voltage rating exhibits better stability. The temperature variation of the X5R dielectric is  $\sim\pm 15\%$  over the  $-40^\circ\text{C}$  to  $+85^\circ\text{C}$  temperature range and is not a function of package or voltage rating.

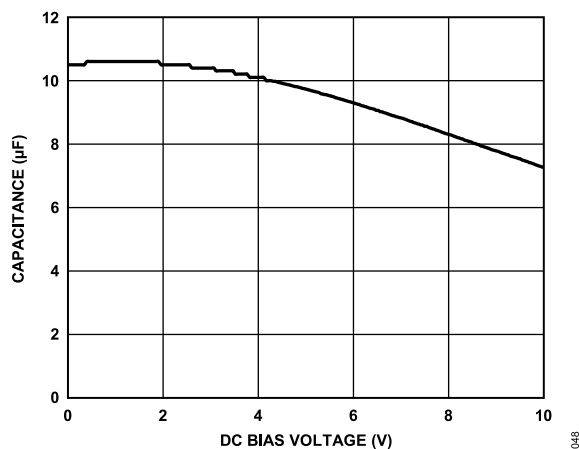

Figure 45. Capacitance vs. DC Bias Voltage

Use Equation 1 to determine the worst case capacitance accounting for capacitor variation over temperature, component tolerance, and voltage.

$$C_{EFF} = C_{BIAS} \times (1 - tempco) \times (1 - TOL) \quad (1)$$

where:

$C_{EFF}$  is the worst case capacitance.

$C_{BIAS}$  is the effective capacitance at the operating voltage.

$tempco$  is the worst case capacitor temperature coefficient.

$TOL$  is the worst case component tolerance.

In this example, the worst case temperature coefficient ( $tempco$ ) over  $-40^\circ\text{C}$  to  $+85^\circ\text{C}$  is assumed to be 15% for an X5R dielectric. The tolerance of the capacitor ( $TOL$ ) is assumed to be 10%, and  $C_{BIAS}$  is 9.72  $\mu\text{F}$  at 5 V, as shown in Figure 45.

Substituting these values in Equation 1 yields

$$C_{EFF} = 9.72 \mu\text{F} \times (1 - 0.15) \times (1 - 0.1) = 7.44 \mu\text{F}$$

Therefore, the capacitor chosen in this example meets the minimum capacitance requirement of the LDO over temperature and tolerance at the chosen output voltage.

To guarantee the performance of the ADP7156, it is imperative that the effects of dc bias, temperature, and tolerances on the behavior of the capacitors be evaluated for each application.

### UNDERVOLTAGE LOCKOUT (UVLO)

The ADP7156 also incorporates an internal UVLO circuit to disable the output voltage when the input voltage is less than the minimum input voltage rating of the regulator. The upper and lower thresholds are internally fixed with 200 mV (typical) of hysteresis.

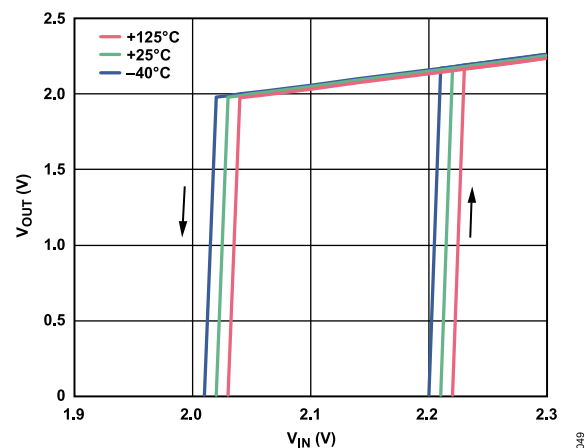

Figure 46. Typical UVLO Behavior at Various Temperatures,  $V_{OUT} = 3.3 \text{ V}$

Figure 46 shows the typical behavior of the UVLO function. This hysteresis prevents on/off oscillations that can occur when caused by noise on the input voltage as it passes through the threshold points.

### PROGRAMMABLE PRECISION ENABLE

The ADP7156 uses the EN pin to enable and disable the VOUT pin under normal operating conditions. As shown in Figure 47, when a rising voltage on EN crosses the upper threshold, nominally 1.22 V,  $V_{OUT}$  turns on. When a falling voltage on EN crosses the lower threshold, nominally 1.13 V,  $V_{OUT}$  turns off. The hysteresis of the EN threshold is typically 90 mV.

The ADP7156 includes a discharge resistor on each VOUT, VREG, REF, and BYP pin. These resistors turn on when the device is disabled, and helps to discharge the associated capacitor very quickly.

APPLICATIONS INFORMATION

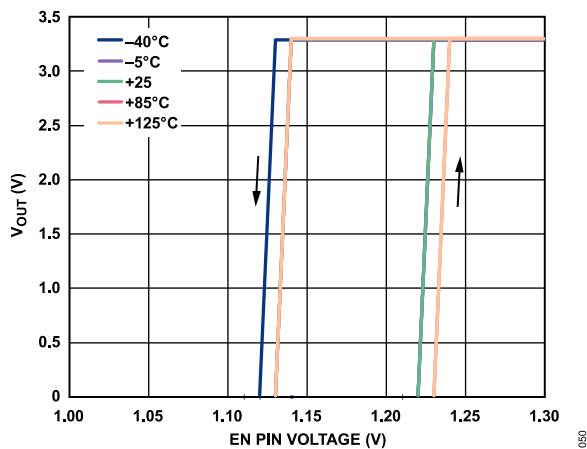

Figure 47. Typical  $V_{OUT}$  Response to EN Pin Operation

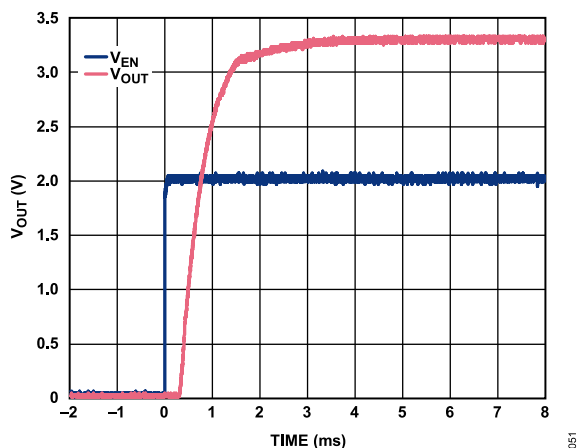

Figure 48. Typical  $V_{OUT}$  Response to EN Pin Operation ( $V_{EN}$ ),  $V_{OUT} = 3.3\text{ V}$ ,  $V_{IN} = 5\text{ V}$ ,  $C_{BYP} = 1\text{ }\mu\text{F}$

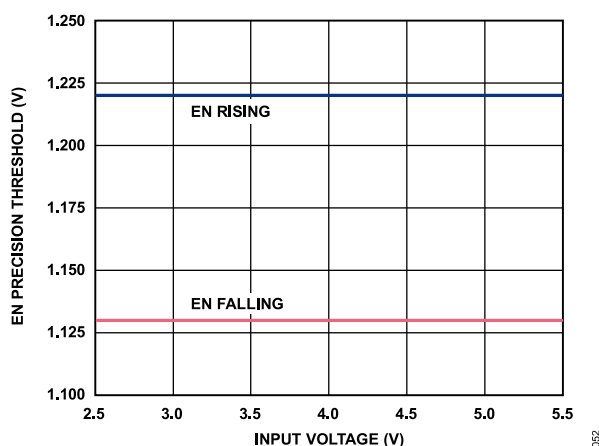

Figure 49. Typical EN Precision Threshold vs. Input Voltage ( $V_{IN}$ )

The upper and lower thresholds are user-programmable and can be set higher than the nominal 1.22 V threshold by using two resistors. Determine the resistance values,  $R_{EN1}$  and  $R_{EN2}$ , from

$$R_{EN1} = R_{EN2} \times (V_{EN} - 1.22\text{ V})/1.22\text{ V}$$

where:

$R_{EN2}$  typically ranges from 10 k $\Omega$  to 100 k $\Omega$ .

$V_{EN}$  is the desired turn-on voltage.

The hysteresis voltage increases by the factor

$$(R_{EN1} + R_{EN2})/R_{EN2}$$

For the example shown in Figure 50, the EN threshold is 2.44 V with a hysteresis of 200 mV.

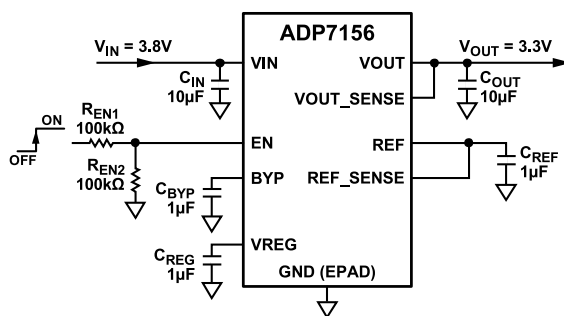

Figure 50. Typical EN Pin Voltage Divider

Figure 50 shows the typical voltage divider configuration of the EN pin. This configuration prevents on/off oscillations that can occur due to noise on the EN pin as it passes through the threshold points.

START-UP TIME

The ADP7156 uses an internal soft start to limit the inrush current when the output is enabled. The start-up time for a 3.3 V output is approximately 1.2 ms from the time the EN active threshold is crossed to when the output reaches 90% of its final value.

The rise time in seconds of the output voltage (10% to 90%) is approximately

$$0.0012 \times C_{BYP}$$

where  $C_{BYP}$  is measured in microfarads.

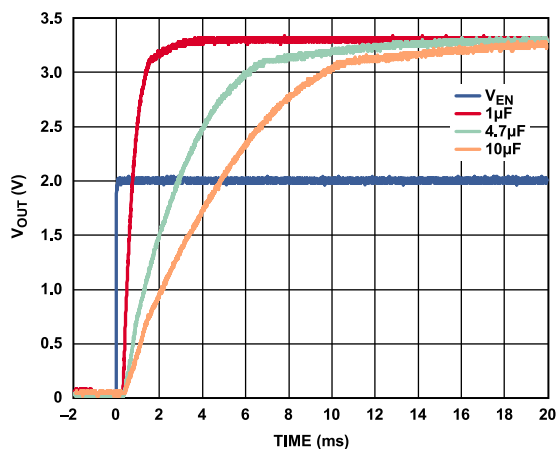

Figure 51. Typical Start-Up Behavior with  $C_{BYP} = 1\text{ }\mu\text{F}$  to  $10\text{ }\mu\text{F}$

## APPLICATIONS INFORMATION

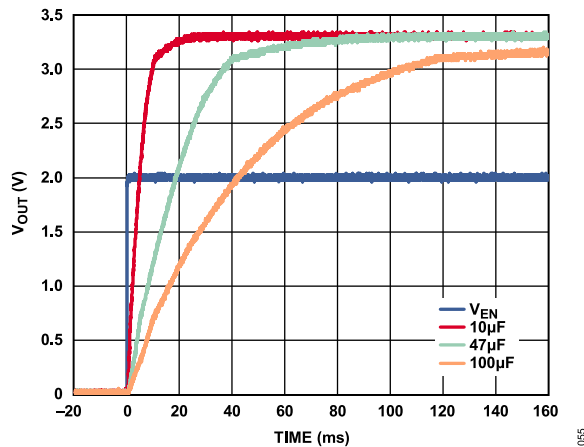

Figure 52. Typical Start-Up Behavior with  $C_{BYP} = 10 \mu\text{F}$  to  $100 \mu\text{F}$

## REF, BYP, AND VREG PINS

REF, BYP, and VREG generate voltages internally ( $V_{REF}$ ,  $V_{BYP}$ , and  $V_{REG}$ ) that require external bypass capacitors for proper operation. Do not, under any circumstances, connect any loads to these pins, because doing so compromises the noise and PSRR performance of the ADP7156. Using larger values of  $C_{BYP}$ ,  $C_{REF}$ , and  $C_{REG}$  is acceptable but can increase the start-up time, as described in the [Start-Up Time](#) section.

## CURRENT-LIMIT AND THERMAL SHUTDOWN

The ADP7156 is protected against damage due to excessive power dissipation by current and thermal overload protection circuits. The ADP7156 is designed to current limit when the output load reaches 1.8 A (typical). When the output load exceeds 1.8 A, the output voltage is reduced to maintain a constant current limit.

When the ADP7156 junction temperature exceeds  $150^\circ\text{C}$ , the thermal shutdown circuit turns off the output voltage, reducing the output current to zero. Extreme junction temperature can be the result of high current operation, poor circuit board design or high ambient temperature. A  $15^\circ\text{C}$  hysteresis is included so that the ADP7156 does not return to operation after thermal shutdown until the on-chip temperature falls below  $135^\circ\text{C}$ . When the device exits thermal shutdown, a soft start is initiated to reduce the inrush current.

Current-limit and thermal shutdown protections are intended to protect the device against accidental overload conditions. For example, a hard short from VOUT to ground or an extremely long soft start timer usually causes thermal oscillations between the current limit and thermal shutdown.

## THERMAL CONSIDERATIONS

In applications with a low input to output voltage differential, the ADP7156 does not dissipate much heat. However, in applications with high ambient temperature and/or high input voltage, the heat dissipated in the package may become large enough that it causes

the junction temperature of the die to exceed the maximum junction temperature of  $125^\circ\text{C}$ .

The junction temperature of the die is the sum of the ambient temperature of the environment and the temperature rise of the package due to the power dissipation, as shown in [Equation 2](#). To guarantee reliable operation, the junction temperature of the ADP7156 must not exceed  $125^\circ\text{C}$ . To ensure that the junction temperature stays below this maximum value, the user must be aware of the parameters that contribute to junction temperature changes. These parameters include ambient temperature, power dissipation in the power device, and thermal resistances between the junction and ambient air ( $\theta_{JA}$ ). The  $\theta_{JA}$  number is dependent on the package assembly compounds that are used and the amount of copper used to solder the exposed pad (ground) to the PCB.

[Table 7](#) shows the typical  $\theta_{JA}$  values of the 8-lead SOIC and 10-lead LFCSP packages for various PCB copper sizes. [Table 8](#) shows the typical  $\Psi_{JB}$  values of the 8-lead SOIC and 10-lead LFCSP.

Table 7. Typical  $\theta_{JA}$  Values

Copper Size (mm <sup>2</sup> )	$\theta_{JA}$ ( $^\circ\text{C}/\text{W}$ )	
	10-Lead LFCSP	8-Lead SOIC
25 <sup>1</sup>	130.2	123.8
100	93.0	90.4
500	65.8	66.0
1000	55.6	56.6
6400	44.1	45.5

<sup>1</sup> Device soldered to minimum size pin traces.

Table 8. Typical  $\Psi_{JB}$  Values

Package	$\Psi_{JB}$ ( $^\circ\text{C}/\text{W}$ )
10-Lead LFCSP	29.1
8-Lead SOIC	30.1

Calculate the junction temperature ( $T_J$ ) of the ADP7156 from the following equation:

$$T_J = T_A + (P_D \times \theta_{JA}) \quad (2)$$

where:

$T_A$  is the ambient temperature.

$P_D$  is the power dissipation in the die, given by

$$P_D = ((V_{IN} - V_{OUT}) \times I_{LOAD}) + (V_{IN} \times I_{GND}) \quad (3)$$

where:

$V_{IN}$  and  $V_{OUT}$  are the input and output voltages, respectively.

$I_{LOAD}$  is the load current.

$I_{GND}$  is the ground current.

Power dissipation caused by ground current is quite small and can be ignored. Therefore, the junction temperature equation simplifies to the following:

$$T_J = T_A + (((V_{IN} - V_{OUT}) \times I_{LOAD}) \times \theta_{JA}) \quad (4)$$

APPLICATIONS INFORMATION

As shown in Equation 4, for a given ambient temperature, input to output voltage differential, and continuous load current, a minimum copper size requirement exists for the PCB to ensure that the junction temperature does not rise above 125°C.

The heat dissipation from the package can be improved by increasing the amount of copper attached to the pins and exposed pad of the ADP7156. Adding thermal planes underneath the package also improves thermal performance. However, as shown in Table 7, a point of diminishing returns is eventually reached, beyond which an increase in the copper area does not yield significant reduction in the junction to ambient thermal resistance.

Figure 53 to Figure 58 show junction temperature calculations for various ambient temperatures, power dissipation, and areas of PCB copper.

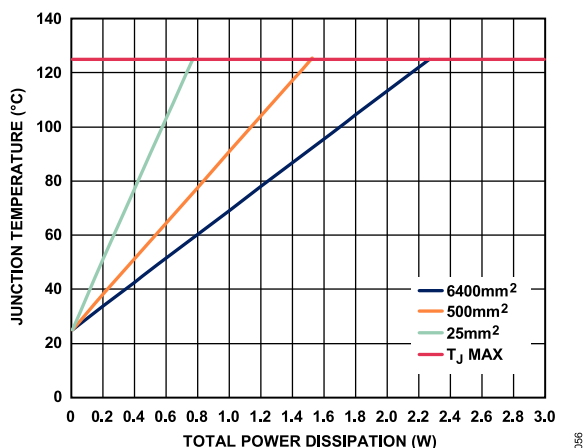

Figure 53. Junction Temperature vs. Total Power Dissipation for the 10-Lead LFCSP,  $T_A = 25^\circ\text{C}$

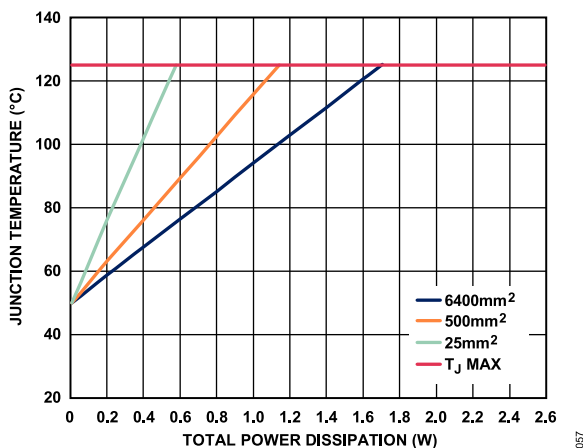

Figure 54. Junction Temperature vs. Total Power Dissipation for the 10-Lead LFCSP,  $T_A = 50^\circ\text{C}$

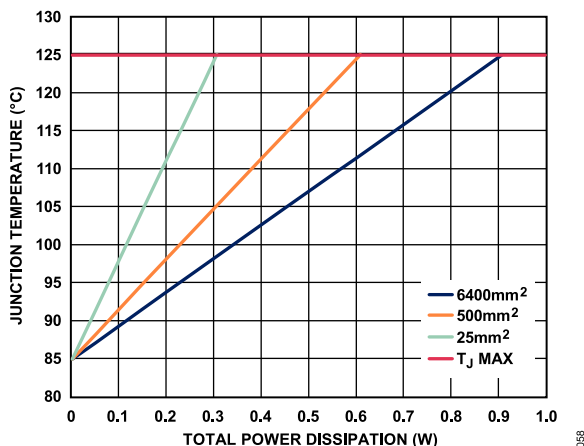

Figure 55. Junction Temperature vs. Total Power Dissipation for the 10-Lead LFCSP,  $T_A = 85^\circ\text{C}$

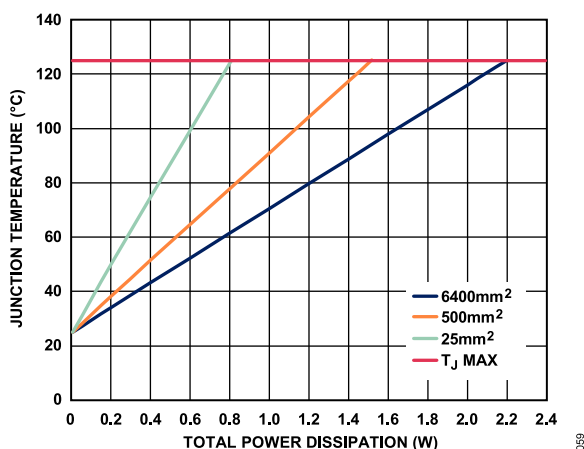

Figure 56. Junction Temperature vs. Total Power Dissipation for the 8-Lead SOIC,  $T_A = 25^\circ\text{C}$

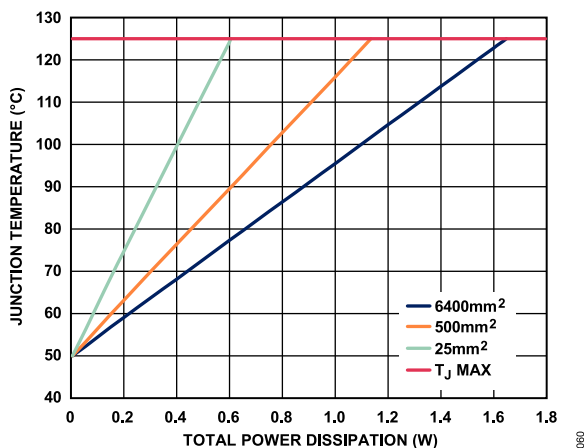

Figure 57. Junction Temperature vs. Total Power Dissipation for the 8-Lead SOIC,  $T_A = 50^\circ\text{C}$

APPLICATIONS INFORMATION

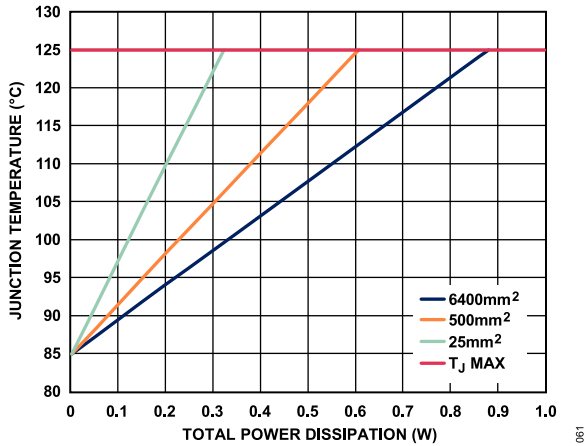

Figure 58. Junction Temperature vs. Total Power Dissipation for the 8-Lead SOIC,  $T_A = 85^\circ\text{C}$

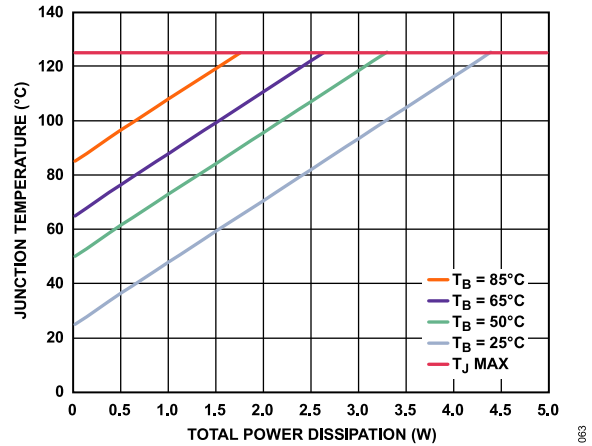

Figure 60. Junction Temperature vs. Total Power Dissipation for the 8-Lead SOIC

Thermal Characterization Parameter ( $\Psi_{JB}$ )

When the evaluation board temperature is known, use the thermal characterization parameter,  $\Psi_{JB}$ , to estimate the junction temperature rise (see Figure 59 and Figure 60). Calculate the maximum junction temperature ( $T_J$ ) from the evaluation board temperature ( $T_B$ ) and power dissipation ( $P_D$ ) using the following formula:

$$T_J = T_B + (P_D \times \Psi_{JB}) \tag{5}$$

The typical value of  $\Psi_{JB}$  is  $29.1^\circ\text{C/W}$  for the 10-lead LFCSP package and  $30.1^\circ\text{C/W}$  for the 8-lead SOIC package.

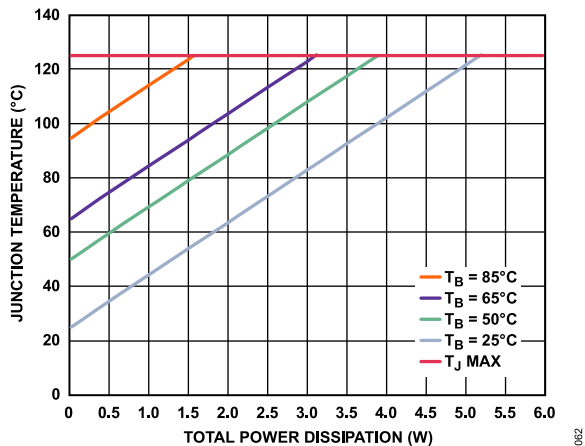

Figure 59. Junction Temperature vs. Total Power Dissipation for the 10-Lead LFCSP

**PRINTED CIRCUIT BOARD (PCB) LAYOUT CONSIDERATIONS**

Place the input capacitor as close as possible between the VIN pin and ground. Place the output capacitor as close as possible between the VOUT pin and ground. Place the bypass capacitors ( $C_{REG}$ ,  $C_{REF}$ , and  $C_{BYP}$ ) for  $V_{REG}$ ,  $V_{REF}$ , and  $V_{BYP}$  close to the respective pins (VREG, REF, and BYP) and ground. The use of a 0805, 0603, or 0402 size capacitor achieves the smallest possible footprint solution on boards where area is limited. Maximize the amount of ground metal for the exposed pad, and use as many vias as possible on the component side to improve thermal dissipation.

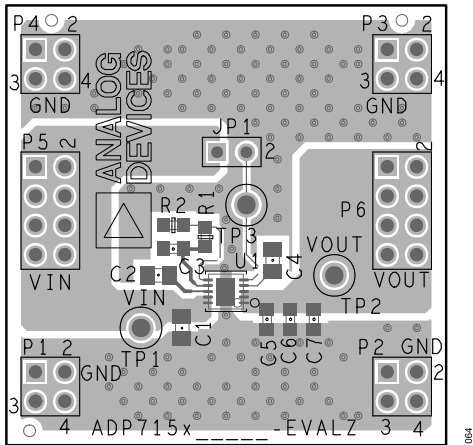

Figure 61. Sample 10-Lead LFCSP PCB Layout

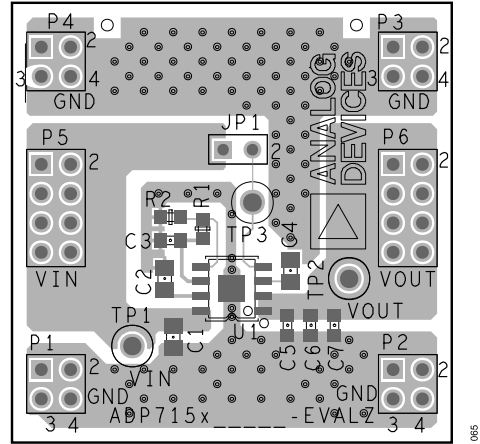

Figure 62. Sample 8-Lead SOIC PCB Layout

OUTLINE DIMENSIONS

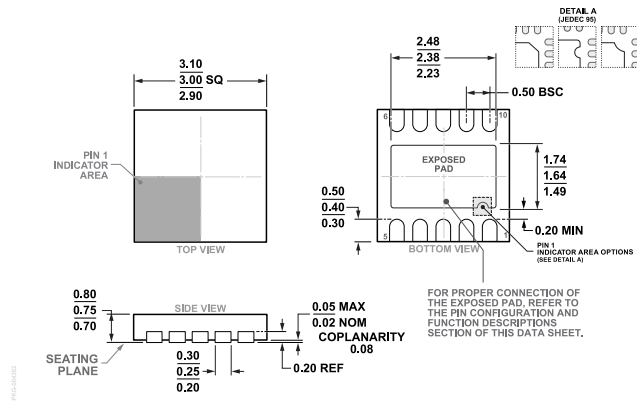

Figure 63. 10-Lead Lead Frame Chip Scale Package [LFCSP]  
3 mm x 3 mm Body and 0.75 mm Package Height  
(CP-10-9)  
Dimensions shown in millimeters

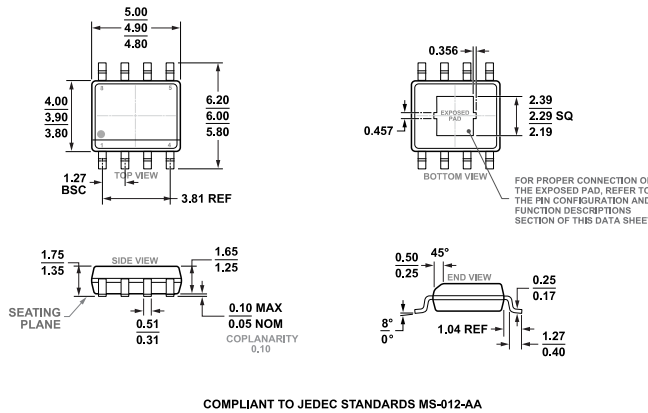

Figure 64. 8-Lead Standard Small Outline Package, with Exposed Pad [SOIC\_N\_EP]  
Narrow Body  
(RD-8-1)  
Dimensions shown in millimeters

Updated: May 02, 2023

ORDERING GUIDE

Table 9. Ordering Guide

Model <sup>1,2</sup>	Temperature Range	Package Description	Packing Quantity	Package Option	Marking Code
ADP7156ACPZ-1.2-R7	-40°C to +125°C	10-Lead LFCSP (3mm x 3mm)	Reel, 1500	CP-10-9	LST
ADP7156ACPZ-1.8-R7	-40°C to +125°C	10-Lead LFCSP (3mm x 3mm)	Reel, 1500	CP-10-9	LSU
ADP7156ACPZ-2.0-R7	-40°C to +125°C	10-Lead LFCSP (3mm x 3mm)	Reel, 1500	CP-10-9	LTQ
ADP7156ACPZ-2.5-R7	-40°C to +125°C	10-Lead LFCSP (3mm x 3mm)	Reel, 1500	CP-10-9	LSV
ADP7156ACPZ-2.8-R7	-40°C to +125°C	10-Lead LFCSP (3mm x 3mm)	Reel, 1500	CP-10-9	LSW
ADP7156ACPZ-3.0-R7	-40°C to +125°C	10-Lead LFCSP (3mm x 3mm)	Reel, 1500	CP-10-9	LSY
ADP7156ACPZ-3.3-R7	-40°C to +125°C	10-Lead LFCSP (3mm x 3mm)	Reel, 1500	CP-10-9	LSZ
ADP7156ARDZ-1.2-R7	-40°C to +125°C	8-Lead SOIC w/ EP	Reel, 1000	RD-8-1	
ADP7156ARDZ-1.8-R7	-40°C to +125°C	8-Lead SOIC w/ EP	Reel, 1000	RD-8-1	
ADP7156ARDZ-2.0-R7	-40°C to +125°C	8-Lead SOIC w/ EP	Reel, 1000	RD-8-1	
ADP7156ARDZ-2.5-R7	-40°C to +125°C	8-Lead SOIC w/ EP	Reel, 1000	RD-8-1	

## OUTLINE DIMENSIONS

**Table 9. Ordering Guide (Continued)**

Model <sup>1,2</sup>	Temperature Range	Package Description	Packing Quantity	Package Option	Marking Code
ADP7156ARDZ-2.8-R7	-40°C to +125°C	8-Lead SOIC w/ EP	Reel, 1000	RD-8-1	
ADP7156ARDZ-3.0-R7	-40°C to +125°C	8-Lead SOIC w/ EP	Reel, 1000	RD-8-1	
ADP7156ARDZ-3.3-R7	-40°C to +125°C	8-Lead SOIC w/ EP	Reel, 1000	RD-8-1	
ADP7156WACPZ-3.3-R7	-40°C to +125°C	10-Lead LFCSP (3mm x 3mm)	Reel, 1500	CP-10-9	LX3

<sup>1</sup> Z = RoHS Compliant Part.

<sup>2</sup> W = Qualified for Automotive Applications.

## OUTPUT VOLTAGE OPTIONS

**Table 10. Output Voltage Options**

Model <sup>1,2,3</sup>	Output Voltage (V)
ADP7156ACPZ-1.2-R7, ADP7156ARDZ-1.2-R7	1.2
ADP7156ACPZ-1.8-R7, ADP7156ARDZ-1.8-R7	1.8
ADP7156ACPZ-2.0-R7, ADP7156ARDZ-2.0-R7	2.0
ADP7156ACPZ-2.5-R7, ADP7156ARDZ-2.5-R7	2.5
ADP7156ACPZ-2.8-R7, ADP7156ARDZ-2.8-R7	2.8
ADP7156ACPZ-3.0-R7, ADP7156ARDZ-3.0-R7	3.0
ADP7156ACPZ-3.3-R7, ADP7156ARDZ-3.3-R7, ADP7156WACPZ-3.3-R7	3.3

<sup>1</sup> Z = RoHS Compliant Part.

<sup>2</sup> W = Qualified for Automotive Applications.

<sup>3</sup> To order a device with voltage options of 1.3 V, 1.5 V, 1.6 V, 2.2 V, 2.6 V, 2.7 V, 2.9 V, 3.1 V, and 3.2 V, contact your local Analog Devices, Inc., sales or distribution representative.

## EVALUATION BOARDS

Model <sup>1</sup>	Description
ADP7156CP-3.3EVALZ	Evaluation Board

<sup>1</sup> Z = RoHS Compliant Part.

## AUTOMOTIVE PRODUCTS

The ADP7156W models are available with controlled manufacturing to support the quality and reliability requirements of automotive applications. Note that these automotive models may have specifications that differ from the commercial models; therefore, designers should review the [Specifications](#) section of this data sheet carefully. Only the automotive grade products shown are available for use in automotive applications. Contact your local Analog Devices account representative for specific product ordering information and to obtain the specific Automotive Reliability reports for these models.

## Looking for pricing, stock, or lifecycle information?

Click below to explore more details on WIN SOURCE:

- ⊖ [View ADP7156ARDZ-1.8-R7 on WIN SOURCE](#)
- ⊖ [Analog Devices Inc. Information](#)

## Optimize Your Supply Chain with WIN SOURCE Solutions

- ✓ Global Sourcing Solution
- ✓ Obsolete Management
- ✓ Cost Control Management
- ✓ Shortage Management
- ✓ Alternative Solution
- ✓ Excess Inventory Management