



**THE DATASHEET OF  
ADRF5027BCCZN**



## FEATURES

**Ultrawideband frequency range: 9 kHz to 44 GHz**

**Nonreflective design**

**Low insertion loss**

1.1 dB to 18 GHz

1.5 dB to 26 GHz

2.2 dB to 40 GHz

3.8 dB to 44 GHz

**High isolation**

53 dB to 18 GHz

48 dB to 26 GHz

48 dB to 40 GHz

43 dB to 44 GHz

**High input linearity**

**P1dB: 26 dBm typical**

**IP3: 54 dBm typical**

**High power handling**

24 dBm insertion loss path

24 dBm isolation path

**All off state control**

**No low frequency spurious signals**

**0.1 dB RF settling time: 6.0  $\mu$ s typical**

**20-terminal, 3 mm  $\times$  3 mm LGA package**

**Pin compatible with [ADRF5026](#), fast switching version**

## APPLICATIONS

**Industrial scanners**

**Test and instrumentation**

**Cellular infrastructure: 5G mmWave**

**Military radios, radars, electronic counter measures (ECMs)**

**Microwave radios and very small aperture terminals (VSATs)**

## GENERAL DESCRIPTION

The ADRF5027 is a nonreflective, single-pole, double-throw (SPDT) radio frequency (RF) switch manufactured in a silicon process.

The ADRF5027 operates from 9 kHz to 44 GHz with better than 3.8 dB of insertion loss and 43 dB of isolation. The ADRF5027 features an all off control, where both RF ports are in an isolation state. The ADRF5027 has a nonreflective design and both of the RF ports are internally terminated to 50  $\Omega$ .

The ADRF5027 requires a dual-supply voltage of +3.3 V and -3.3 V. The device employs complimentary metal-oxide semiconductor/low-voltage transistor-transistor logic (CMOS/LVTTL) logic-compatible controls.

## FUNCTIONAL BLOCK DIAGRAM

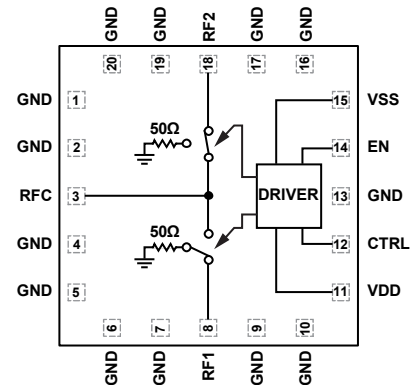

Figure 1.

18768-001

The ADRF5027 is pin compatible with the [ADRF5026](#) fast switching version, which operates from 100 MHz to 44 GHz.

The ADRF5027 RF ports are designed to match a characteristic impedance of 50  $\Omega$ . For ultrawideband products, impedance matching on the RF transmission lines can further optimize high frequency insertion loss and return loss characteristics. Refer to the Narrow-Band Impedance Matching section for an example of a matched circuit that achieves a low insertion loss response of 2.2 dB from 28 GHz to 43 GHz.

The ADRF5027 comes in a 20-terminal, 3 mm  $\times$  3 mm, RoHS-compliant, land grid array (LGA) package and can operate from -40°C to +105°C.

Rev. A

[Document Feedback](#)

Information furnished by Analog Devices is believed to be accurate and reliable. However, no responsibility is assumed by Analog Devices for its use, nor for any infringements of patents or other rights of third parties that may result from its use. Specifications subject to change without notice. No license is granted by implication or otherwise under any patent or patent rights of Analog Devices. Trademarks and registered trademarks are the property of their respective owners.

**TABLE OF CONTENTS**

Features .....	1	Interface Schematics .....	6
Applications .....	1	Typical Performance Characteristics .....	7
Functional Block Diagram .....	1	Insertion Loss, Return Loss, and Isolation .....	7
General Description .....	1	Input Power Compressions and Third-Order Intercept .....	8
Revision History .....	2	Theory of Operation .....	9
Specifications .....	3	Applications Information .....	10
Electrical Specifications .....	3	Evaluation Board .....	10
Absolute Maximum Ratings .....	5	Probe Matrix Board .....	11
Thermal Resistance .....	5	Outline Dimensions .....	13
Power Derating Curves .....	5	Ordering Guide .....	13
ESD Caution .....	5		
Pin Configuration and Function Descriptions .....	6		

**REVISION HISTORY**

**9/2020—Rev. 0 to Rev. A**

Changes to Table 2 .....	5
Changes to Theory of Operation Section .....	9
Changes to Ordering Guide .....	12

**7/2018—Revision 0: Initial Version**

# SPECIFICATIONS

## ELECTRICAL SPECIFICATIONS

VDD = 3.3 V, VSS = -3.3 V, V<sub>CTRL</sub>/V<sub>EN</sub> = 0 V or VDD, and T<sub>CASE</sub> = 25°C in a 50 Ω system, unless otherwise noted.

Table 1.

Parameter	Symbol	Test Conditions/Comments	Min	Typ	Max	Unit
FREQUENCY RANGE			0.009		44,000	MHz
INSERTION LOSS	IL					
Between RFC and RF1/RF2		9 kHz to 18 GHz		1.1		dB
		18 GHz to 26 GHz		1.5		dB
		26 GHz to 35 GHz		1.9		dB
		35 GHz to 40 GHz		2.2		dB
		40 GHz to 44 GHz <sup>1</sup>		3.8		dB
RETURN LOSS	RL					
RFC and RF1/RF2 (On)		9 kHz to 18 GHz		18		dB
		18 GHz to 26 GHz		14		dB
		26 GHz to 35 GHz		14		dB
		35 GHz to 40 GHz		12		dB
		40 GHz to 44 GHz <sup>1</sup>		7		dB
RF1/RF2 (Off)		9 kHz to 18 GHz		28		dB
		18 GHz to 26 GHz		28		dB
		26 GHz to 35 GHz		17		dB
		35 GHz to 40 GHz		13		dB
		40 GHz to 44 GHz <sup>1</sup>		10		dB
ISOLATION						
Between RFC and RF1/RF2		9 kHz to 18 GHz		53		dB
		18 GHz to 26 GHz		48		dB
		26 GHz to 35 GHz		48		dB
		35 GHz to 40 GHz		48		dB
		40 GHz to 44 GHz		43		dB
Between RF1 and RF2		9 kHz to 18 GHz		60		dB
		18 GHz to 26 GHz		60		dB
		26 GHz to 35 GHz		60		dB
		35 GHz to 40 GHz		60		dB
		40 GHz to 44 GHz		50		dB
SWITCHING CHARACTERISTICS						
Rise and Fall Time	t <sub>RISE</sub> , t <sub>FALL</sub>	10% to 90% of RF output		1.3		μs
On and Off Time	t <sub>ON</sub> , t <sub>OFF</sub>	50% of triggered V <sub>CTRL</sub> to 90% of RF output		3.6		μs
RF Settling Time						
0.1 dB		50% of triggered V <sub>CTRL</sub> to 0.1 dB of final RF output		6.0		μs
0.05 dB		50% of triggered V <sub>CTRL</sub> to 0.05 dB of final RF output		7.5		μs
INPUT LINEARITY <sup>2</sup>						
1 dB Compression	P1dB	200 kHz to 40 GHz		26		dBm
Third-Order Intercept	IP3	Two-tone input power = 12 dBm each tone, Δf = 1 MHz		54		dBm
SUPPLY CURRENT		VDD and VSS pins				
Positive	I <sub>DD</sub>			2		μA
Negative	I <sub>SS</sub>			100		μA
DIGITAL CONTROL INPUTS		CTRL and EN pins				
Voltage						
Low	V <sub>INL</sub>		0	0.8		V
High	V <sub>INH</sub>		1.2	3.3		V
Current						
Low and High Current	I <sub>INL</sub> , I <sub>INH</sub>			<1		μA

Parameter	Symbol	Test Conditions/Comments	Min	Typ	Max	Unit
RECOMMENDED OPERATING CONDITIONS						
Supply Voltage						
Positive	V <sub>DD</sub>		3.15		3.45	V
Negative	V <sub>SS</sub>		-3.45		-3.15	V
Digital Control Voltage	V <sub>CTRL</sub> , V <sub>EN</sub>		0		V <sub>DD</sub>	V
RF Input Power <sup>3</sup>	P <sub>IN</sub>	f = 200 kHz to 40 GHz, T <sub>CASE</sub> = 85°C <sup>4</sup>				
Insertion Loss Path		RF signal is applied to the RFC or through connected RF1/RF2			24	dBm
Isolation Path		RF signal is applied to terminated RF1/RF2			24	dBm
Hot Switching		RF signal is present at the RFC while switching between RF1 and RF2			24	dBm
Case Temperature	T <sub>CASE</sub>		-40		+105	°C

<sup>1</sup> Impedence matching on RF transmission lines improves high frequency performance. Refer to the Applications Information section for more information.

<sup>2</sup> For input linearity performance vs. frequency, see Figure 11 and Figure 13.

<sup>3</sup> For power derating vs. frequency, see Figure 2 and Figure 3. This power derating is applicable for insertion loss path, isolation path, and hot switching power specifications.

<sup>4</sup> For 105°C operation, the power handling degrades from the T<sub>CASE</sub> = 85°C specification by 3 dB.

## ABSOLUTE MAXIMUM RATINGS

For recommended operating conditions, see Table 1.

Table 2.

Parameter	Rating
Positive Supply Voltage	-0.3 V to +3.6 V
Negative Supply Voltage	-3.6 V to +0.3 V
Digital Control Inputs	
Voltage	-0.3 V to VDD +0.3 V
Current	3 mA
RF Input Power <sup>1</sup> (200 kHz to 40 GHz at T <sub>CASE</sub> = 85°C <sup>2</sup> )	
Insertion Loss Path	26 dBm
Isolation Path	25 dBm
Hot Switching	25 dBm
RF Input Power Under Unbiased Condition (V <sub>DD</sub> , V <sub>SS</sub> = 0 V)	20 dBm
Temperature	
Junction, T <sub>J</sub>	135°C
Storage Range	-65°C to +150°C
Reflow	260°C
Electrostatic Discharge (ESD) Sensitivity	
Human Body Model (HBM)	
RFC, RF1, RF2 Pins	1500 V
Digital Pins	2000 V
Charged Device Model (CDM)	1250 V

<sup>1</sup> For power derating vs. frequency, see Figure 2 and Figure 3. This power derating is applicable for insertion loss path, isolation path, and hot switching power specifications.

<sup>2</sup> For 105°C operation, the power handling degrades from the T<sub>CASE</sub> = 85°C specification by 3 dB.

Stresses at or above those listed under Absolute Maximum Ratings may cause permanent damage to the product. This is a stress rating only; functional operation of the product at these or any other conditions above those indicated in the operational section of this specification is not implied. Operation beyond the maximum operating conditions for extended periods may affect product reliability.

Only one absolute maximum rating can be applied at any one time.

### THERMAL RESISTANCE

Thermal performance is directly linked to printed circuit board (PCB) design and operating environment. Careful attention to PCB thermal design is required.

$\theta_{JC}$  is the junction to case bottom (channel to package bottom) thermal resistance.

Table 3. Thermal Resistance

Package Type	$\theta_{JC}$	Unit
CC-20-3		
Through Path	423	°C/W
Terminated Path	241	°C/W

### POWER DERATING CURVES

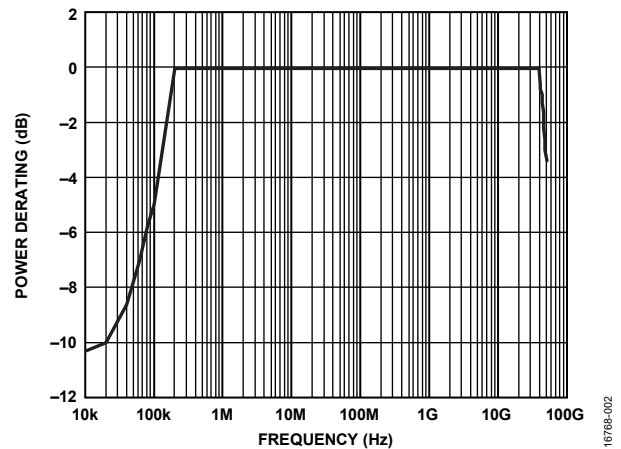

Figure 2. Power Derating vs. Frequency, Low Frequency Detail, T<sub>CASE</sub> = 85°C

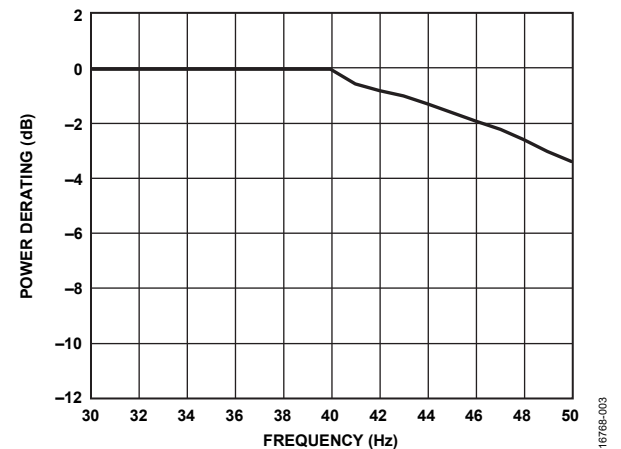

Figure 3. Power Derating vs. Frequency, High Frequency Detail, T<sub>CASE</sub> = 85°C

### ESD CAUTION



**ESD (electrostatic discharge) sensitive device.** Charged devices and circuit boards can discharge without detection. Although this product features patented or proprietary protection circuitry, damage may occur on devices subjected to high energy ESD. Therefore, proper ESD precautions should be taken to avoid performance degradation or loss of functionality.

# PIN CONFIGURATION AND FUNCTION DESCRIPTIONS

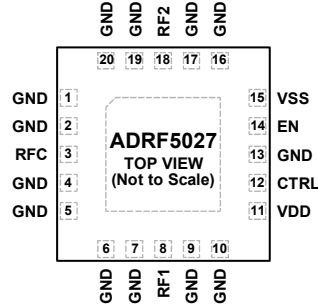

NOTES  
 1. THE EXPOSED PAD MUST BE CONNECTED TO RF AND DC GROUND OF THE PCB.

16758-004

Figure 4. Pin Configuration

Table 4. Pin Function Descriptions

Pin No.	Mnemonic	Description
1, 2, 4, 5, 6, 7, 9, 10, 13, 16, 17, 19, 20	GND	Ground. These pins must be connected to the RF and dc ground of the PCB.
3	RFC	RF Common Port. This pin is dc-coupled to 0 V and ac matched to 50 Ω. No dc blocking capacitor is necessary when the RF line potential is equal to 0 V dc. See Figure 5 for the interface schematic.
8	RF1	RF1 Port. This pin is dc-coupled to 0 V and ac matched to 50 Ω. No dc blocking capacitor is necessary when the RF line potential is equal to 0 V dc. See Figure 5 for the interface schematic.
11	VDD	Positive Supply Voltage.
12	CTRL	Control Input Voltage. See Table 5 for the truth table. See Figure 6 for the interface schematic.
14	EN	Enable Input Voltage. See Table 5 for the truth table. See Figure 6 for the interface schematic.
15	VSS	Negative Supply Voltage.
18	RF2	RF2 Port. This pin is dc-coupled to 0 V and ac matched to 50 Ω. No dc blocking capacitor is necessary when the RF line potential is equal to 0 V dc. See Figure 5 for the interface schematic.
	EPAD	Exposed Pad. The exposed pad must be connected to the RF and dc ground of the PCB.

## INTERFACE SCHEMATICS

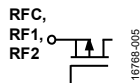

Figure 5. RFC, RF1, RF2 Interface Schematic

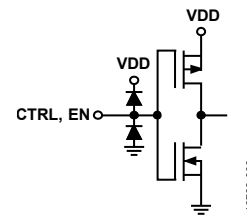

Figure 6. CTRL, EN Interface Schematic

## TYPICAL PERFORMANCE CHARACTERISTICS

### INSERTION LOSS, RETURN LOSS, AND ISOLATION

VDD = 3.3 V, VSS = -3.3 V, V<sub>CTRL</sub>/V<sub>EN</sub> = 0 V or VDD, and T<sub>CASE</sub> = 25°C in a 50 Ω system, unless otherwise noted.

Insertion loss and return loss are measured on the probe matrix board using ground-signal-ground (GSG) probes close to the RFx pins. Signal coupling between the probes limits the isolation performance of ADRF5027. Isolation is measured on the [ADRF5027-EVALZ](#) evaluation board. See the Applications Information section for details on the [ADRF5027-EVALZ](#) evaluation board and probe matrix board.

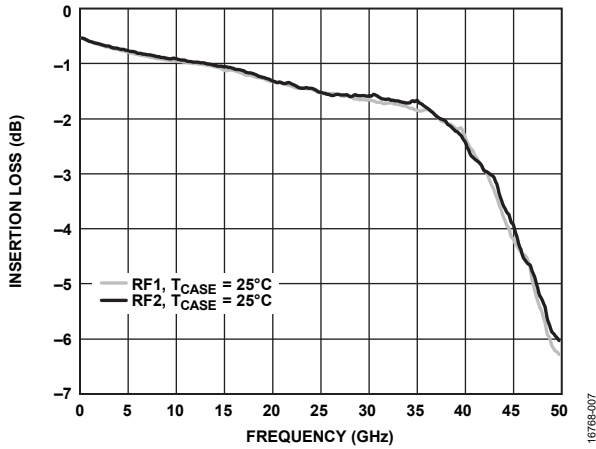

Figure 7. Insertion Loss vs. Frequency at Room Temperature for RF1 and RF2

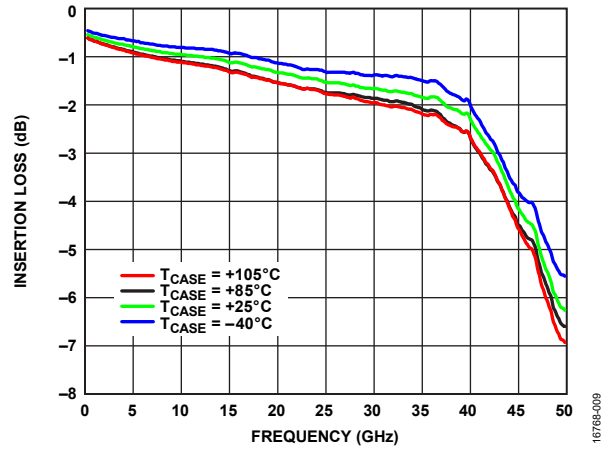

Figure 9. Insertion Loss vs. Frequency over Temperature

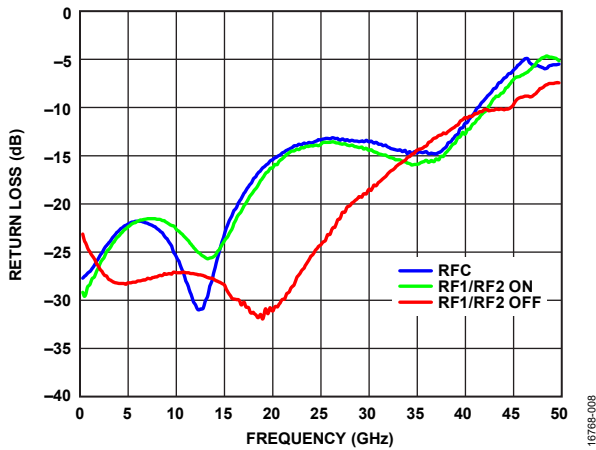

Figure 8. Return Loss vs. Frequency

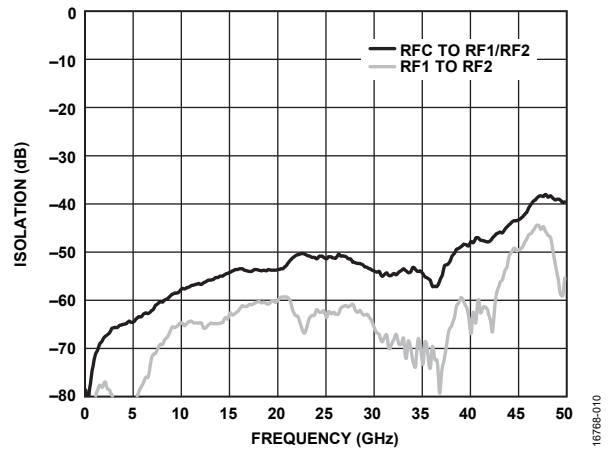

Figure 10. Isolation vs. Frequency

**INPUT POWER COMPRESSIONS AND THIRD-ORDER INTERCEPT**

VDD = 3.3 V, VSS = -3.3 V, VCTRL/VEN = 0 V or VDD, and TCASE = 25°C in a 50 Ω system, unless otherwise noted. All of the large signal performance parameters are measured on the [ADRF5027-EVALZ](#) evaluation board.

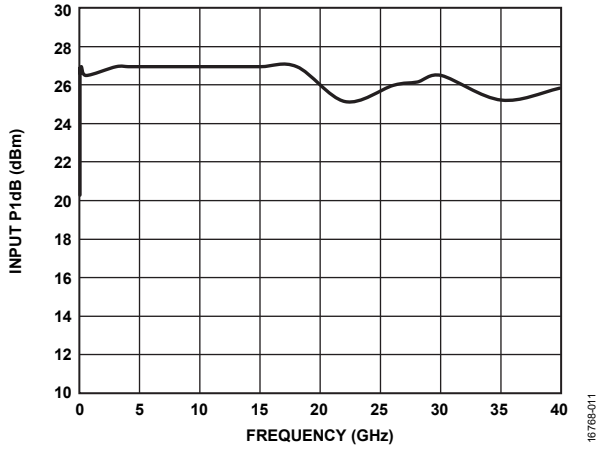

Figure 11. Input P1dB vs. Frequency

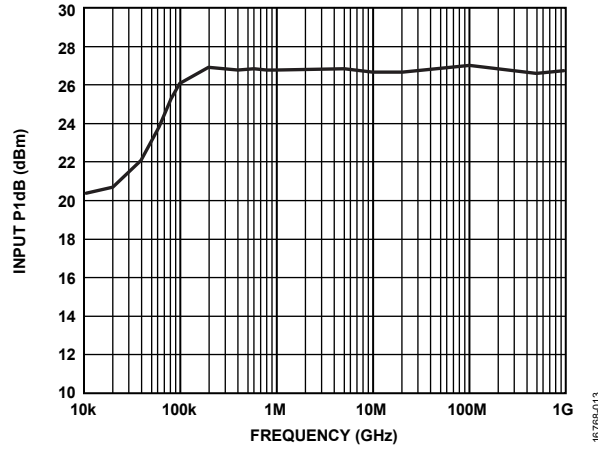

Figure 13. Input P1dB vs. Frequency (Low Frequency Detail)

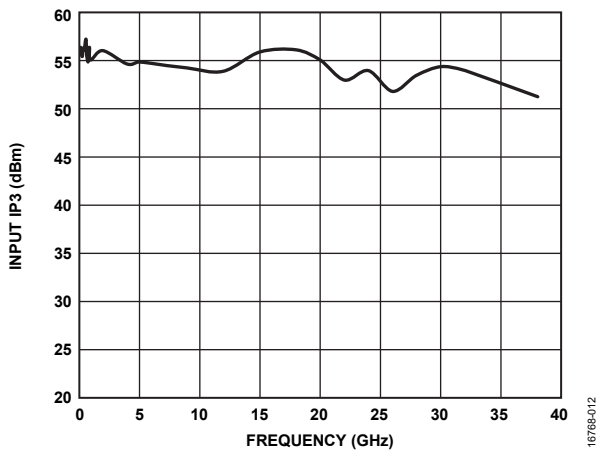

Figure 12. Input IP3 vs. Frequency

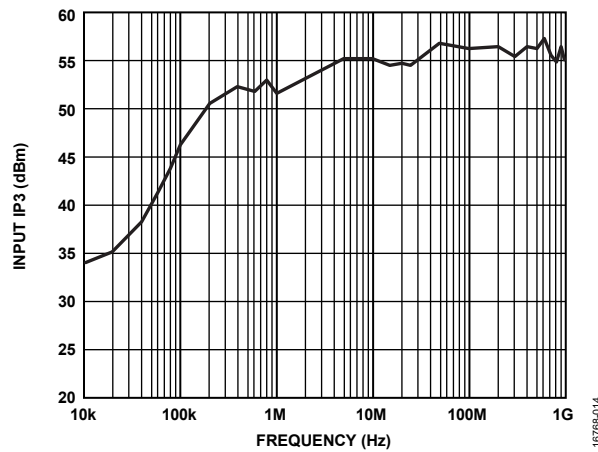

Figure 14. Input IP3 vs. Frequency (Low Frequency Detail)

## THEORY OF OPERATION

The ADRF5027 requires a positive supply voltage applied to the VDD pin and a negative supply voltage applied to the VSS pin. Bypassing capacitors are recommended on the supply lines to filter high frequency noise.

All of the RF ports (RFC, RF1, and RF2) are dc-coupled to 0 V, and no dc blocking capacitors are required at the RF ports when the RF potential is equal to 0 V.

The RF ports are internally matched to 50  $\Omega$ . Therefore, external matching networks are not required. Impedance matching on the RF transmission lines can improve insertion loss and return loss performance at high frequencies.

The ADRF5027 integrates a driver to perform logic function internally and to provide the advantage of a simplified control interface. The driver features two digital control input pins, CTRL and EN. When the EN pin is logic low, the logic level applied to the CTRL pin determines which RF port is in insertion loss state and which RF port is in isolation state.

The ADRF5027 supports an all off state control. When the EN pin is logic high, both the RF1 to RFC path and the RF2 to RFC path are in an isolation state, regardless of the logic state of the CTRL pin. The RF1 and RF2 ports are terminated to internal 50  $\Omega$  resistors, and the RFC port becomes open reflective (see Table 5).

The ADRF5027 design is bidirectional with equal power handling capabilities. An RF input signal ( $RF_{IN}$ ) can be applied to the RFC port or the RF1 or RF2 port. The isolation path provides high loss between the unselected RFX port and the insertion loss path.

The ideal power-up sequence is as follows:

1. Connect GND.
2. Power up VDD and VSS. Power up VSS after VDD to avoid current transients on VDD during ramp-up.
3. Apply the digital control inputs. The relative order of the digital control inputs is not important. However, powering the digital control inputs before the VDD supply may inadvertently forward bias and damage the internal ESD protection structures. To avoid this damage, use a series 1 k $\Omega$  resistor to limit the current flowing in to the control pin. Use pull-up or pull-down resistors if the controller output is in a high impedance state after VDD is powered up and the control pins are not driven to a valid logic state.
4. Apply an RF input signal to RFC, RF1, or RF2.

The ideal power-down sequence is the reverse order of the power-up sequence.

**Table 5. Control Voltage Truth Table**

Digital Control Input		RF Paths	
EN	CTRL	RF1 to RFC	RF2 to RFC
Low	Low	Isolation (off)	Insertion loss (on)
Low	High	Insertion loss (on)	Isolation (off)
High	Low	Isolation (off)	Isolation (off)
High	High	Isolation (off)	Isolation (off)

## APPLICATIONS INFORMATION

### EVALUATION BOARD

The [ADRF5027-EVALZ](#) evaluation board is a 4-layer evaluation board. The outer copper (Cu) layers are 0.5 oz (0.7 mil) plated to 1.5 oz (2.2 mil) and are separated by dielectric materials. Figure 15 shows the [ADRF5027-EVALZ](#) evaluation board stack up.

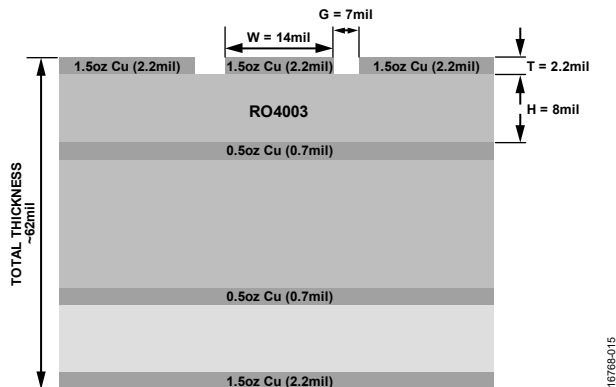

Figure 15. Evaluation Board Stack Up

All RF and dc traces are routed on the top copper layer, whereas the inner and bottom layers are ground planes that provide a solid ground for the RF transmission lines. The top dielectric material is 8 mil Rogers RO4003, which offers optimal high frequency performance. The middle and bottom dielectric materials provide mechanical strength. The overall board thickness is 62 mil, which allows 2.4 mm RF launchers to be connected at the board edges.



Figure 16. Evaluation Board Layout

The RF transmission lines are designed using a coplanar waveguide (CPWG) model with a width of 14 mil and a ground spacing of 7 mil, and have a characteristic impedance of 50 Ω. For optimal RF and thermal grounding, as many plated through vias as possible are arranged around transmission lines and under the exposed pad of the package.

The RF input and output ports (RFC, RF1, and RF2) are connected through 50 Ω transmission lines to the 2.4 mm launchers (J1, J2, and J3, respectively). These high frequency RF launchers are connected by contact and are not soldered to the board.

The thru calibration line, THRU CAL, can calibrate out the board loss effects from the [ADRF5027-EVALZ](#) evaluation board measurements to determine the device performance at the pins of the IC. Figure 17 shows the typical board loss for the [ADRF5027-EVALZ](#) evaluation board at room temperature, the

embedded insertion loss, and the de-embedded insertion loss for the ADRF5027.

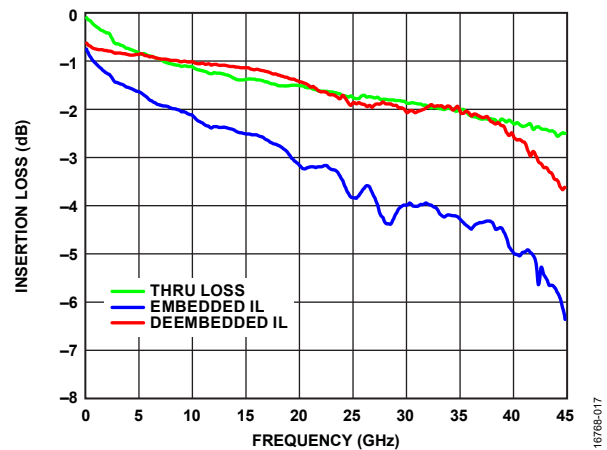

Figure 17. Insertion Loss vs. Frequency

Two power supply ports are connected to the VDD and VSS test points, and the ground reference is connected to the GND test point. On the supply traces, VDD and VSS, a 100 pF bypass capacitor filters high frequency noise. Additionally, unpopulated component positions are available for applying extra bypass capacitors.

Two control ports are connected to the EN and CTRL test points. There are provisions for the resistor capacitor (RC) filter to eliminate dc-coupled noise, if needed by the application.

The [ADRF5027-EVALZ](#) evaluation board schematic is shown in Figure 18.

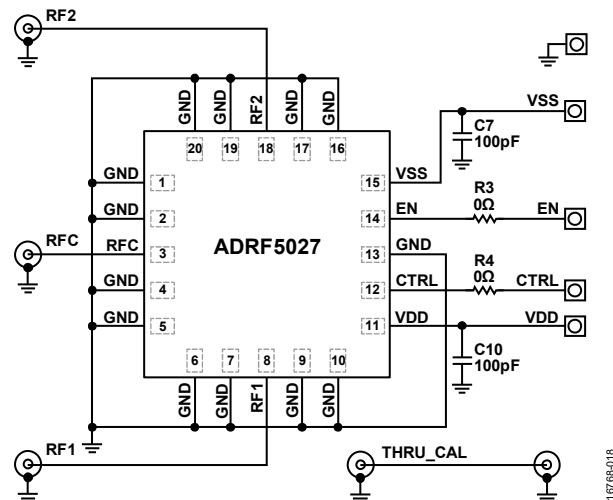

Figure 18. Simplified Evaluation Board Schematic

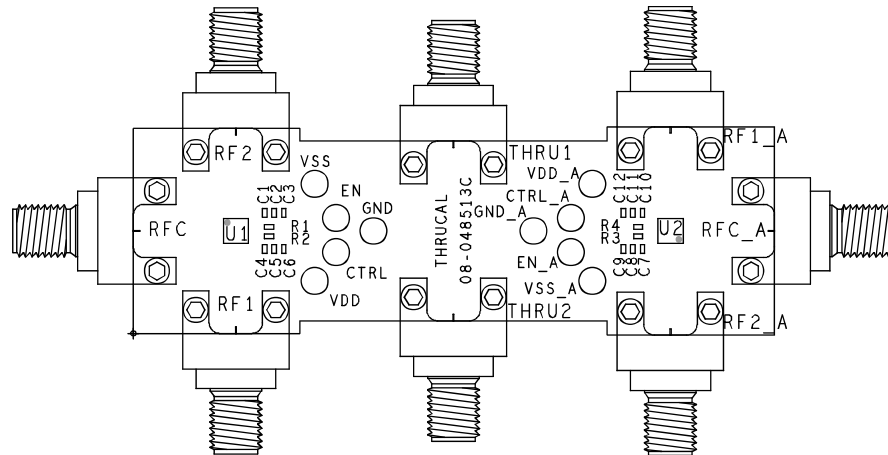

Figure 19. Evaluation Board Component Placement

16788-019

Table 6. Evaluation Board Components

Component	Description
RF1_A, RFC_A, RF2_A	End launch connectors, 2.4 mm
VDD_A, VSS_A, CTRL_A, EN_A, GND_A	Through-hole mount test points
C7, C10	100 pF capacitors, 0402 package
R3, R4	0 Ω resistors, 0402 package
U2	ADRF5027 SPDT switch

**PROBE MATRIX BOARD**

The probe matrix board is a 4-layer board. This board also uses an 8 mil Rogers RO4003 dielectric. The outer copper layers are 0.5 oz (0.7 mil) plated to 1.5 oz (2.2 mil). The RF transmission lines were designed using a CPWG model with a width of 14 mil and a ground spacing of 7 mil to have a characteristic impedance of 50 Ω.

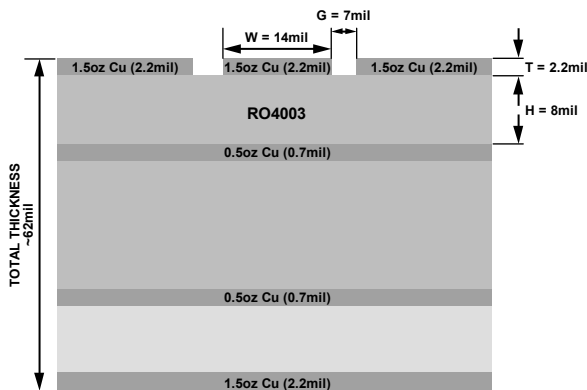

Figure 20. Probe Matrix Board Stack Up

16788-020

Figure 20 and Figure 21 show the stack up and the layout, respectively, of the probe matrix board. Measurements are made using GSG probes at close proximity to the RF pins. Probing reduces the reflections caused by mismatch arising from connectors, cables, and board layout, resulting in a more accurate measurement of insertion loss and return loss. Signal coupling between the RF probes limits the isolation

measurement. The [ADRF5027-EVALZ](#) evaluation board is used for making isolation measurements.

RF traces for a through-reflect-line (TRL) calibration are designed on the probe matrix board. Board loss is compensated for by using a nonzero line length at calibration. The actual board duplicates the same layout in matrix form, which allows multiple devices to assemble at once. Insertion loss and return loss measurements are made on this board, while isolation measurements are made on the [ADRF5027-EVALZ](#) evaluation board.

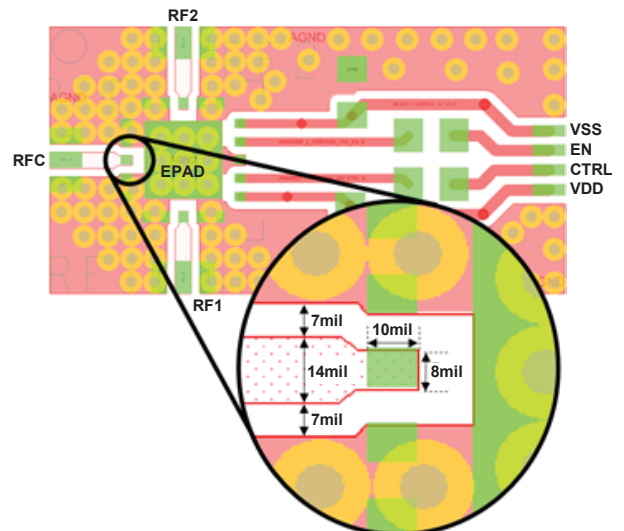

Figure 21. Probe Matrix Board Layout

16788-021

**Narrow-Band Impedance Matching**

**5G mmWave Frequencies**

Narrow-band impedance matching on the RF transmission lines can improve return loss and insertion loss for a targeted frequency range. The impedance matched circuit, highlighted in Figure 22, achieves a low insertion loss response of 2.2 dB from 28 GHz to 35 GHz (see Figure 23). The dimensions of the 50 Ω lines are 14 mil trace width and a 7 mil gap. To implement this impedance matched circuit, an 8 mil trace with a width of 5 mil is inserted between the pin pad and the 50 Ω trace.

Table 7, Figure 23, Figure 24, and Figure 25 show the measured performance of ADRF5027 on the impedance matched circuit on the probe matrix board.

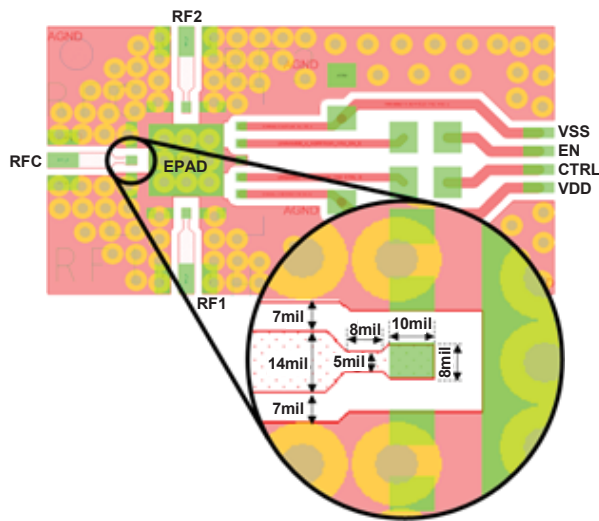

Figure 22. Impedance Matched Circuit

**Table 7. Impedance Matched Parameters**

Parameter	Test Condition	Typ	Unit
Insertion Loss Between RFC and RF1/RF2	See Figure 23		
	9 kHz to 18 GHz	1.1	dB
	18 GHz to 26 GHz	1.8	dB
	26 GHz to 35 GHz	2.3	dB
	35 GHz to 40 GHz	2.2	dB
Return Loss	See Figure 24		
	RFC and RF1/RF2 (On)		
	9 kHz to 18 GHz	20	dB
	18 GHz to 26 GHz	8	dB
	26 GHz to 35 GHz	7	dB
RF1/RF2 (Off)	See Figure 24		
	9 kHz to 18 GHz	25	dB
	18 GHz to 26 GHz	23	dB
	26 GHz to 35 GHz	17	dB
	35 GHz to 40 GHz	11	dB
40 GHz to 44 GHz	7	dB	

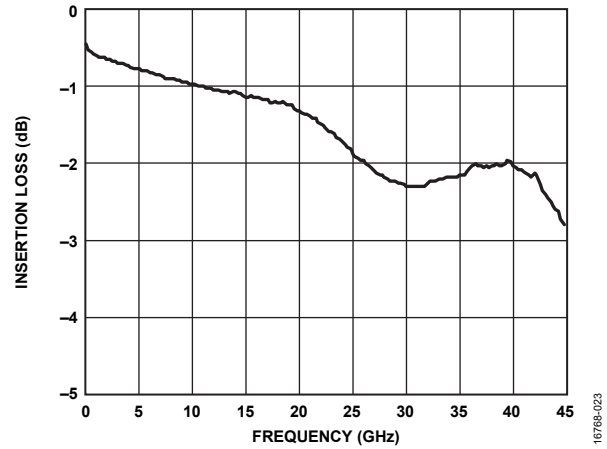

Figure 23. Insertion Loss vs. Frequency, with Impedance Matching

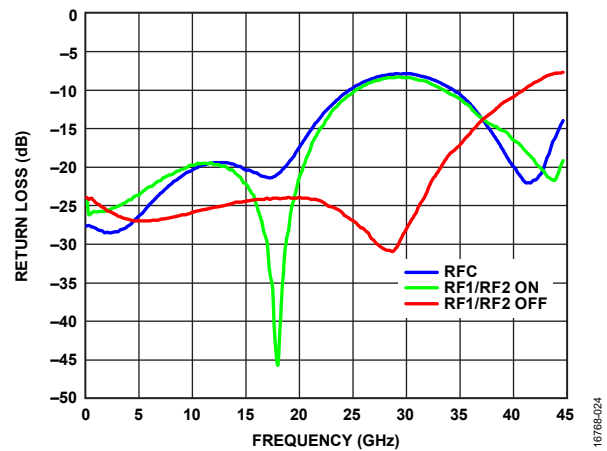

Figure 24. Return Loss vs. Frequency, with Impedance Matching

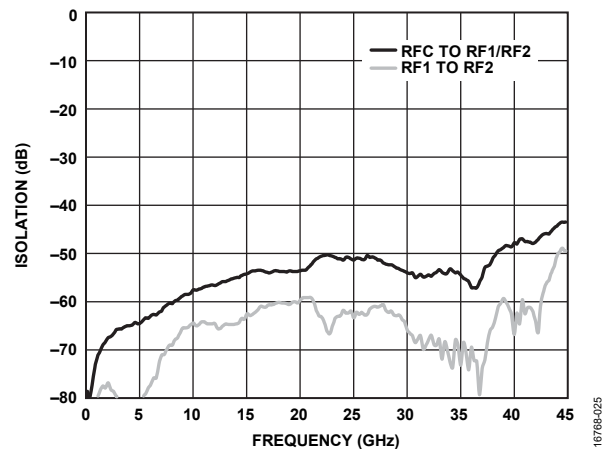

Figure 25. Isolation vs. Frequency, with Impedance Matching

### OUTLINE DIMENSIONS

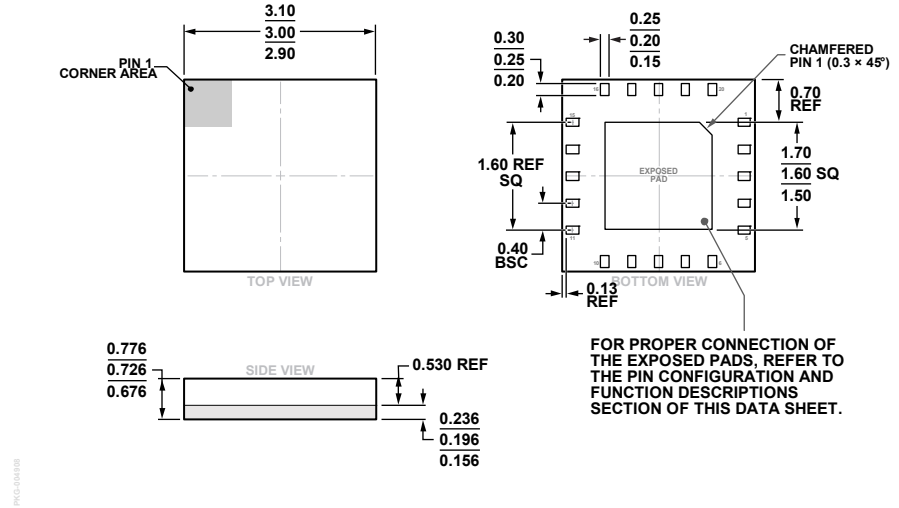

Figure 26. 20-Terminal Land Grid Array [LGA]  
 3 mm × 3 mm Body and 0.726 mm Package Height  
 (CC-20-3)  
 Dimensions shown in millimeters

### ORDERING GUIDE

Model <sup>1</sup>	Temperature Range	Package Description	Package Option	Marking Code
ADRF5027BCCZN	−40°C to +105°C	20-Terminal Land Grid Array [LGA]	CC-20-3	027
ADRF5027BCCZN-R7	−40°C to +105°C	20-Terminal Land Grid Array [LGA]	CC-20-3	027
ADRF5027-EVALZ-292		Evaluation Board with 2.92 mm connectors		
ADRF5027-EVALZ-240		Evaluation Board with 2.40 mm connectors		

<sup>1</sup> Z = RoHS Compliant Part.

## Looking for pricing, stock, or lifecycle information?

Click below to explore more details on WIN SOURCE:

 [View ADRF5027BCCZN on WIN SOURCE](#)

 [Analog Devices Inc. Information](#)

## Optimize Your Supply Chain with WIN SOURCE Solutions

-  Global Sourcing Solution
-  Obsolete Management
-  Cost Control Management
-  Shortage Management
-  Alternative Solution
-  Excess Inventory Management