



**THE DATASHEET OF  
AP63200QWU-7**



## Description

The AP63200Q/AP63201Q/AP63203Q/AP63205Q is an automotive-compliant, 2A, synchronous buck converter with a wide input voltage range of 3.8V to 32V. The device fully integrates a 125mΩ high-side power MOSFET and a 68mΩ low-side power MOSFET to provide high-efficiency step-down DC-DC conversion.

The AP63200Q/AP63201Q/AP63203Q/AP63205Q device is easily used by minimizing the external component count due to its adoption of peak current mode control along with its integrated loop compensation network.

The AP63200Q/AP63201Q/AP63203Q/AP63205Q design is optimized for Electromagnetic Interference (EMI) reduction. The device has a proprietary gate driver scheme to resist switching node ringing without sacrificing MOSFET turn-on and turn-off times, which reduces high-frequency radiated EMI noise caused by MOSFET switching. The AP63200Q/AP63203Q/AP63205Q also features Frequency Spread Spectrum (FSS) with a switching frequency jitter of  $\pm 6\%$ , which reduces EMI by not allowing emitted energy to stay in any one frequency for a significant period of time.

The device is available in a TSOT26 package.

## Features

- AEC-Q100 Qualified for Automotive Applications
  - Device Temperature Grade 1: -40°C to +125°C T<sub>A</sub> Range
- VIN: 3.8V to 32V
- Output Voltage (V<sub>OUT</sub>)
  - 0.8V to VIN: AP63200Q and AP63201Q
  - Fixed 3.3V: AP63203Q
  - Fixed 5V: AP63205Q
- 2A Continuous Output Current
- 0.8V  $\pm$  1% Reference Voltage
- 22μA Low Quiescent Current (Pulse Frequency Modulation)
- Switching Frequency
  - 500kHz: AP63200Q and AP63201Q
  - 1100kHz: AP63203Q and AP63205Q
- Supports Pulse Frequency Modulation (PFM)
  - AP63200Q, AP63203Q, and AP63205Q
  - Up to 88% Efficiency at 5mA Light Load
- Pulse Width Modulation (PWM) Regardless of Output Load
  - AP63201Q
- Proprietary Gate Driver Design for Best EMI Reduction
- Frequency Spread Spectrum (FSS) to Reduce EMI
  - AP63200Q, AP63203Q, and AP63205Q
- Low-Dropout (LDO) Mode
- Precision Enable Threshold to Adjust UVLO
- Protection Circuitry
  - Undervoltage Lockout (UVLO)
  - Output Overvoltage Protection (OVP)
  - Cycle-by-Cycle Peak Current Limit
  - Thermal Shutdown
- **Totally Lead-Free & Fully RoHS Compliant (Notes 1 & 2)**
- **Halogen and Antimony Free. "Green" Device (Note 3)**
- **The AP63200Q, AP63201Q, AP63203Q, and AP63205Q are suitable for automotive applications requiring specific change control; these parts are AEC-Q100 qualified, PPAP capable, and manufactured in IATF 16949 certified facilities.**  
<https://www.diodes.com/quality/product-definitions/>

- Notes:
1. No purposely added lead. Fully EU Directive 2002/95/EC (RoHS), 2011/65/EU (RoHS 2) & 2015/863/EU (RoHS 3) compliant.
  2. See <https://www.diodes.com/quality/lead-free/> for more information about Diodes Incorporated's definitions of Halogen- and Antimony-free, "Green" and Lead-free.
  3. Halogen- and Antimony-free "Green" products are defined as those which contain <900ppm bromine, <900ppm chlorine (<1500ppm total Br + Cl) and <1000ppm antimony compounds.

## Pin Assignments

(Top View)

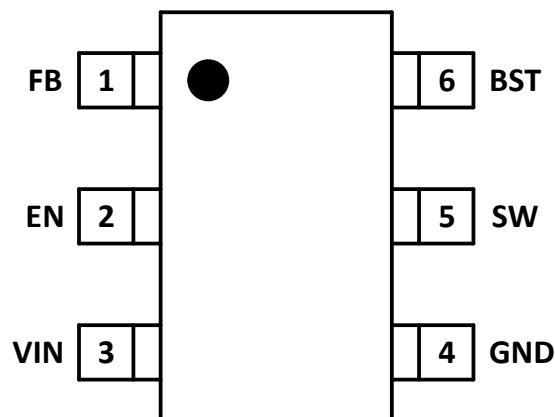

TSOT26

## Applications

- Automotive Power Systems
- Automotive Infotainment
- Automotive Instrument Clusters
- Automotive Body Electronics and Lighting
- Automotive Telematics
- Advanced Driver Assistance Systems

**Typical Application Circuit**

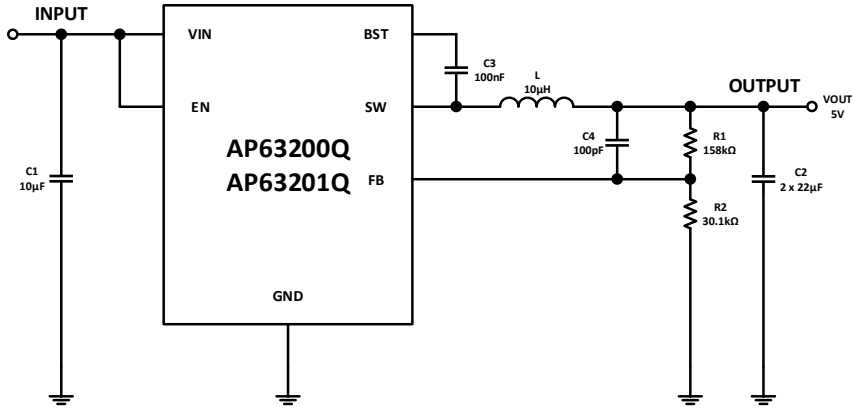

Figure 1. Typical Application Circuit, AP63200Q/AP63201Q

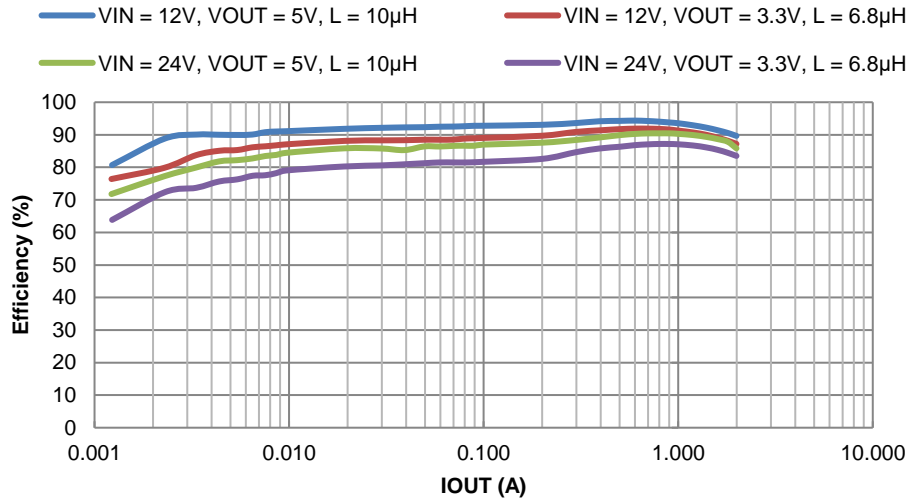

Figure 2. Efficiency vs. Output Current, AP63200Q

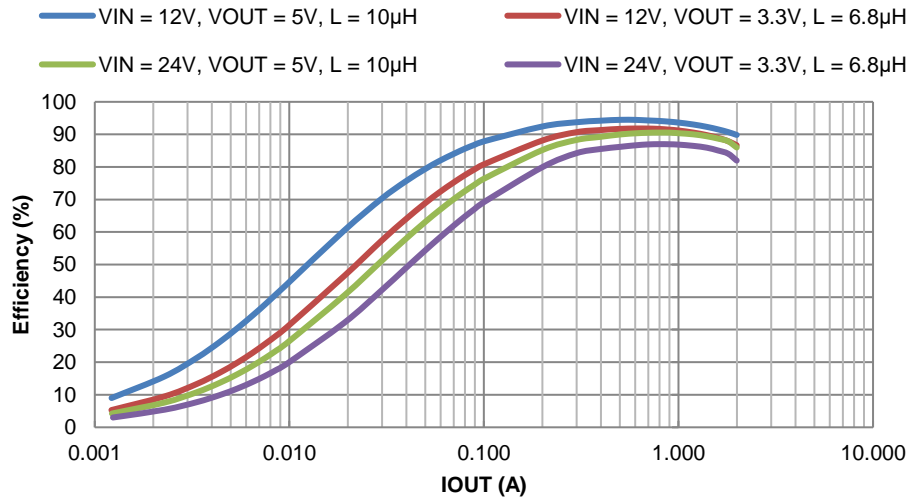

Figure 3. Efficiency vs. Output Current, AP63201Q

**Typical Application Circuit** (continued)

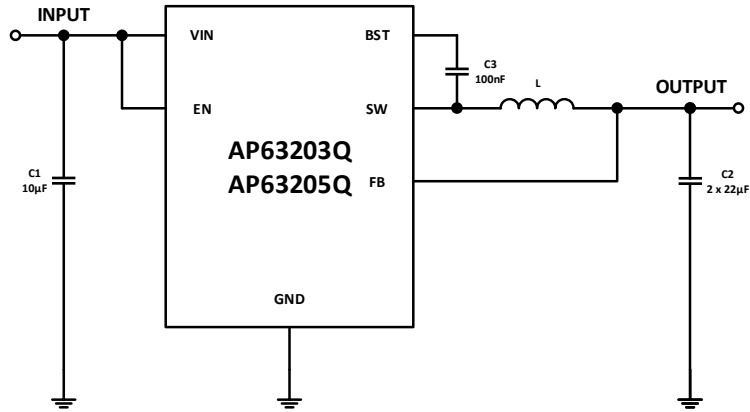

Figure 4. Typical Application Circuit, AP63203Q/AP63205Q

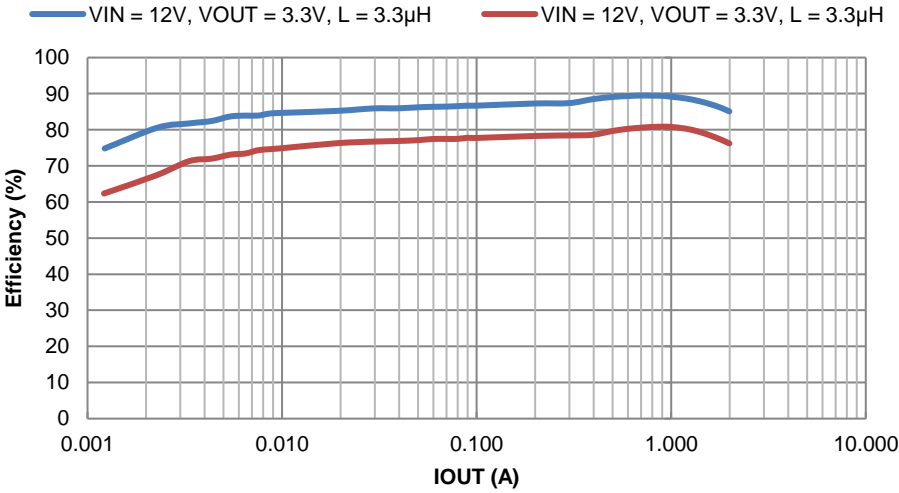

Figure 5. Efficiency vs. Output Current, AP63203Q

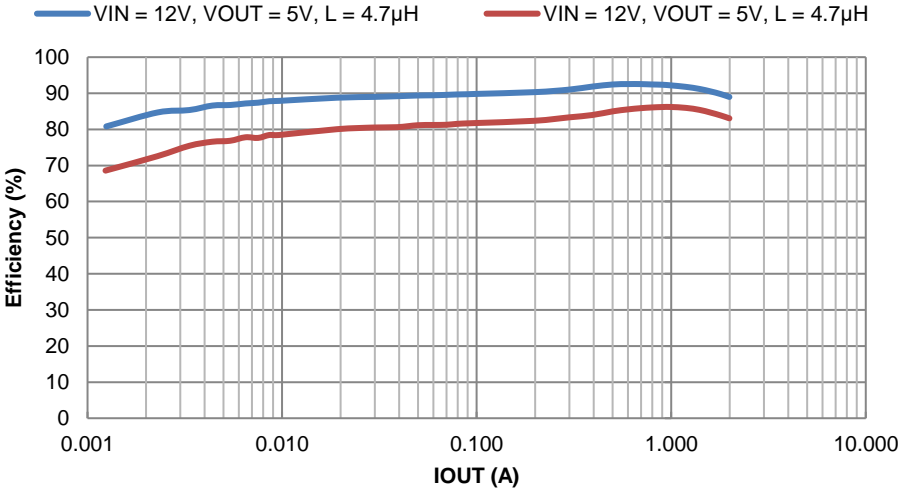

Figure 6. Efficiency vs. Output Current, AP63205Q

**Pin Descriptions**

Pin Name	Pin Number	Function
FB	1	Feedback sensing terminal for the output voltage. Connect this pin to the resistive divider of the output. See <b>Setting the Output Voltage</b> section for more details.
EN	2	Enable Input. EN is a digital input that turns the regulator on or off. Drive EN high to turn on the regulator and low to turn it off. Connect to VIN or leave floating for automatic startup. The EN has a precision threshold of 1.18V for adjusting the UVLO. See <b>Enable</b> section for more details.
VIN	3	Power Input. VIN supplies the power to the IC as well as the step-down converter's power MOSFETs. Drive VIN with a 3.8V to 32V power source. Bypass VIN to GND with a suitably large capacitor to eliminate noise due to the switching of the IC. See <b>Input Capacitor</b> section for more details.
GND	4	Power Ground.
SW	5	Power Switching Output. SW is the switching node that supplies power to the output. Connect the output LC filter from SW to the output load.
BST	6	High-Side Gate Drive Boost Input. BST supplies the drive for the high-side N-channel power MOSFET. A 100nF capacitor is recommended from BST to SW to power the high-side driver.

**Functional Block Diagram**

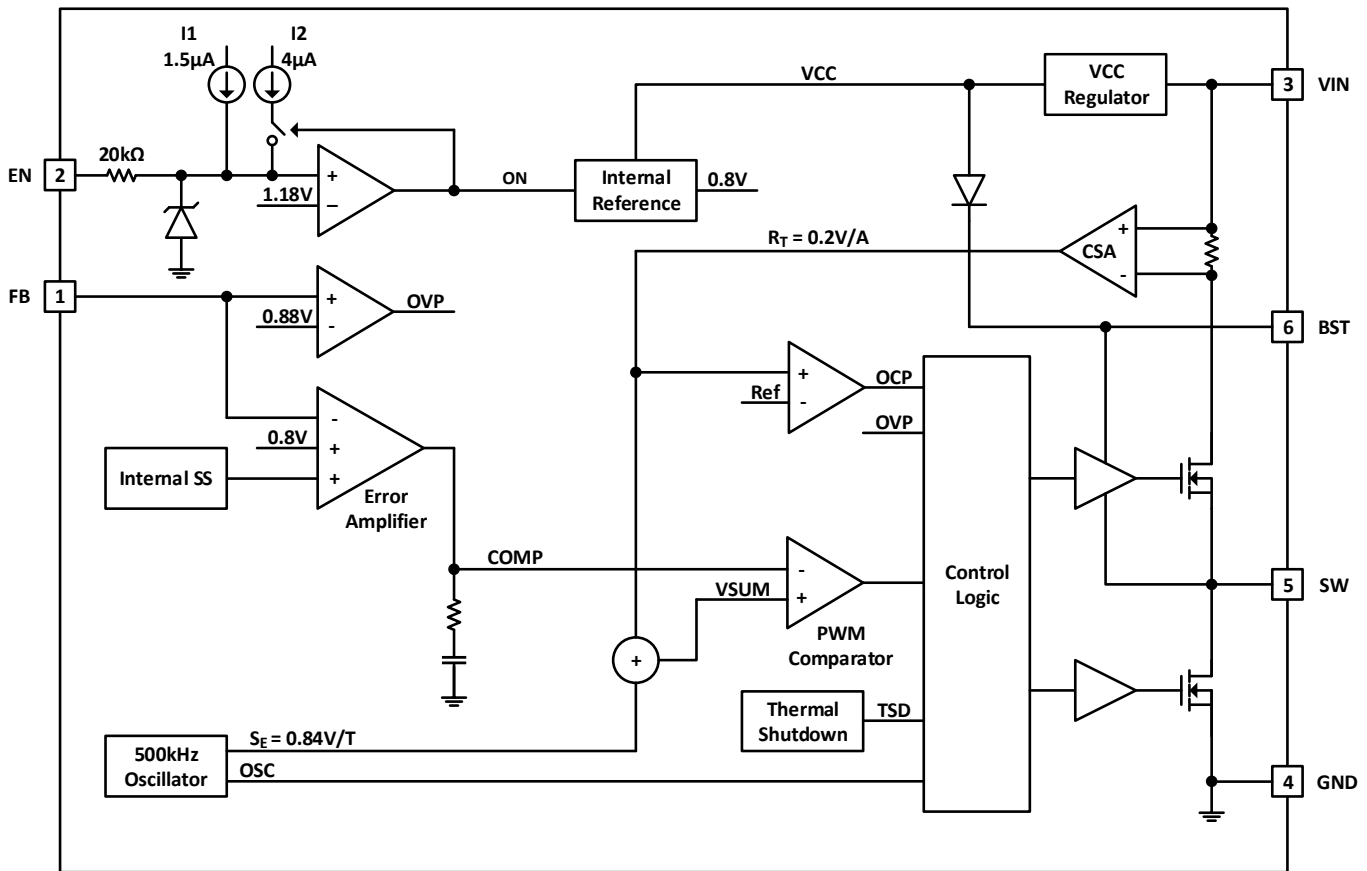

Figure 7. Functional Block Diagram

**Absolute Maximum Ratings** (Note 4) (@ T<sub>A</sub> = +25°C, unless otherwise specified.)

Symbol	Parameter	Rating	Unit
VIN	Supply Pin Voltage	-0.3 to +35.0 (DC)	V
		-0.3 to +40.0 (400ms)	
V <sub>FB</sub>	Feedback Pin Voltage	-0.3 to +6.0	V
V <sub>EN</sub>	Enable/UVLO Pin Voltage	-0.3 to +35.0	V
V <sub>SW</sub>	Switch Pin Voltage	-0.3 to VIN + 0.3 (DC)	V
		-2.5 to VIN + 2.0 (20ns)	
V <sub>BST</sub>	Bootstrap Pin Voltage	V <sub>SW</sub> - 0.3 to V <sub>SW</sub> + 6.0	V
T <sub>STG</sub>	Storage Temperature	-65 to +150	°C
T <sub>J</sub>	Junction Temperature	+160	°C
T <sub>L</sub>	Lead Temperature	+260	°C
<b>ESD Susceptibility (Note 5)</b>			
HBM	Human Body Model	±2000	V
CDM	Charged Device Model	±1500	V

- Notes:
4. Stresses greater than the *Absolute Maximum Ratings* specified above can cause permanent damage to the device. These are stress ratings only; functional operation of the device at these or any other conditions exceeding those indicated in this specification is not implied. Device reliability can be affected by exposure to absolute maximum rating conditions for extended periods of time.
  5. Semiconductor devices are ESD sensitive and can be damaged by exposure to ESD events. Suitable ESD precautions should be taken when handling and transporting these devices.

**Thermal Resistance** (Note 6)

Symbol	Parameter	Rating		Unit
		TSOT26		
θ <sub>JA</sub>	Junction to Ambient	TSOT26	89	°C/W
θ <sub>JC</sub>	Junction to Case	TSOT26	39	°C/W

- Note: 6. Test condition for TSOT26: Device mounted on FR-4 substrate, single-layer PC board, 2oz copper, with minimum recommended pad layout.

**Recommended Operating Conditions** (Note 7) (@ T<sub>A</sub> = +25°C, unless otherwise specified.)

Symbol	Parameter	Min	Max	Unit
V <sub>IN</sub>	Supply Voltage	3.8	32	V
V <sub>OUT</sub>	Output Voltage	0.8	V <sub>IN</sub>	V
T <sub>A</sub>	Operating Ambient Temperature	-40	+125	°C
T <sub>J</sub>	Operating Junction Temperature	-40	+150	°C

- Note: 7. The device function is not guaranteed outside of the recommended operating conditions.

**Electrical Characteristics** (@  $T_J = +25^\circ\text{C}$ ,  $V_{IN} = 12\text{V}$ , unless otherwise specified. Min/Max limits apply across the recommended operating junction temperature range,  $-40^\circ\text{C}$  to  $+150^\circ\text{C}$ , and input voltage range, 3.8V to 32V, unless otherwise specified.)

Symbol	Parameter	Conditions	Min	Typ	Max	Unit
ISHDN	Shutdown Supply Current	$V_{EN} = 0\text{V}$	—	1	—	$\mu\text{A}$
I <sub>Q</sub>	Quiescent Supply Current	AP63200Q: L = Open, $V_{EN} = \text{Floating}, V_{FB} = 1.0\text{V}$	—	22	—	$\mu\text{A}$
		AP63201Q: L = Open, $V_{EN} = \text{Floating}, V_{FB} = 1.0\text{V}$	—	370	—	$\mu\text{A}$
		AP63203Q: L = Open, $V_{EN} = \text{Floating}, V_{FB} = 3.5\text{V}$	—	22	—	$\mu\text{A}$
		AP63205Q: L = Open, $V_{EN} = \text{Floating}, V_{FB} = 5.2\text{V}$	—	22	—	$\mu\text{A}$
POR	VIN Power-on Reset Rising Threshold	—	—	3.5	3.7	V
UVLO	VIN Undervoltage Lockout Falling Threshold	—	—	3.06	—	V
R <sub>DS(ON)1</sub>	High-Side Power MOSFET On-Resistance (Note 8)	—	—	125	—	m $\Omega$
R <sub>DS(ON)2</sub>	Low-Side Power MOSFET On-Resistance (Note 8)	—	—	68	—	m $\Omega$
I <sub>PEAK_LIMIT</sub>	HS Peak Current Limit (Note 8)	From Drain to Source	2.35	2.8	3.25	A
I <sub>VALLEY_LIMIT</sub>	LS Valley Current Limit (Note 8)	From Source to Drain	—	3.2	—	A
f <sub>sw</sub>	Oscillator Frequency	AP63200Q/AP63201Q, CCM	450	500	550	kHz
		AP63203Q/AP63205Q, CCM	990	1100	1210	kHz
t <sub>ON_MIN</sub>	Minimum On-Time	—	—	80	—	ns
V <sub>FB</sub>	Feedback Voltage	AP63200Q/AP63201Q, CCM	0.792	0.800	0.808	V
		AP63203Q, CCM	3.267	3.300	3.333	V
		AP63205Q, CCM	4.950	5.000	5.050	V
V <sub>EN_H</sub>	EN Logic High Threshold	—	—	1.18	1.25	V
V <sub>EN_L</sub>	EN Logic Low Threshold	—	1.03	1.09	—	V
I <sub>EN</sub>	EN Input Current	$V_{EN} = 1.5\text{V}$	—	5.5	—	$\mu\text{A}$
		$V_{EN} = 1\text{V}$	1.0	1.5	2.0	$\mu\text{A}$
t <sub>SS</sub>	Soft-Start Time	—	—	4	—	ms
T <sub>SD</sub>	Thermal Shutdown (Note 8)	—	—	+160	—	$^\circ\text{C}$
T <sub>Hys</sub>	Thermal Shutdown Hysteresis (Note 8)	—	—	+25	—	$^\circ\text{C}$

Note: 8. Compliance to the datasheet limits is assured by one or more methods: production test, characterization, and/or design.

**Typical Performance Characteristics** (AP63200Q/AP63201Q/AP63203Q/AP63205Q @  $T_A = +25^\circ\text{C}$ ,  $V_{IN} = 12\text{V}$ ,  $V_{OUT} = 5\text{V}$ , BOM = Table 1, unless otherwise specified.)

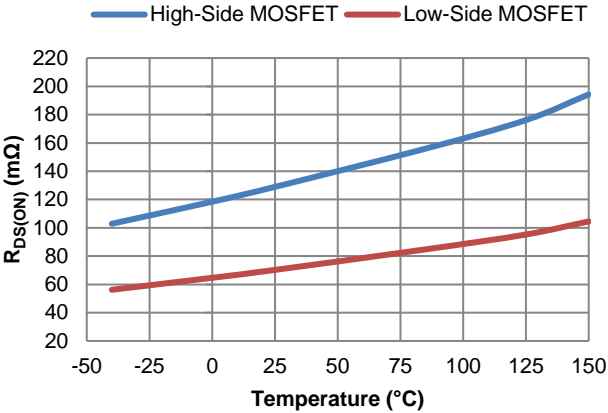

Figure 8. Power MOSFET  $R_{DS(ON)}$  vs. Temperature

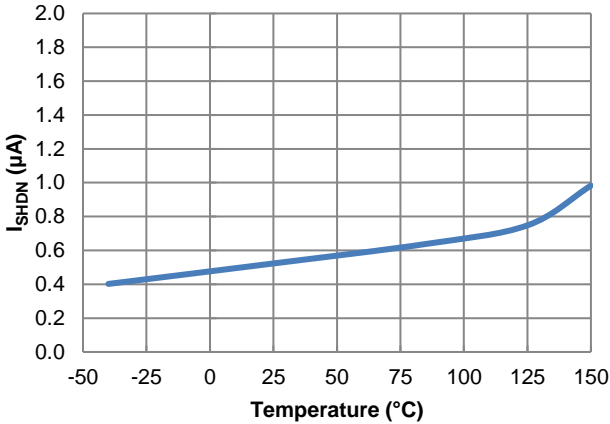

Figure 9.  $I_{SHDN}$  vs. Temperature

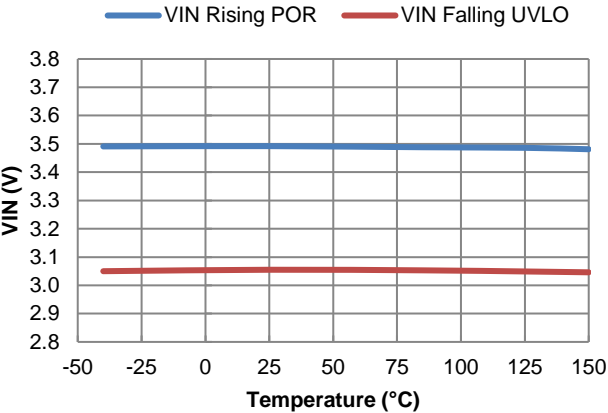

Figure 10. VIN Power-On Reset and UVLO vs. Temperature

**Typical Performance Characteristics** (AP63200Q/AP63201Q @  $T_A = +25^\circ\text{C}$ ,  $V_{IN} = 12\text{V}$ ,  $V_{OUT} = 5\text{V}$ , BOM = Table 1, unless otherwise specified.)

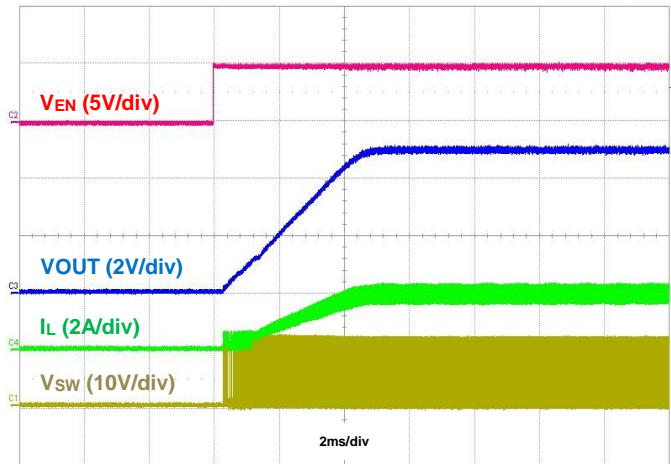

Figure 11. Startup using EN, IOUT = 2A

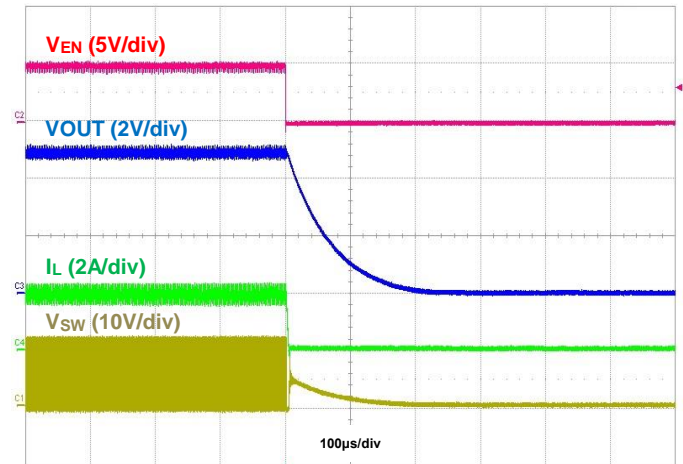

Figure 12. Shutdown using EN, IOUT = 2A

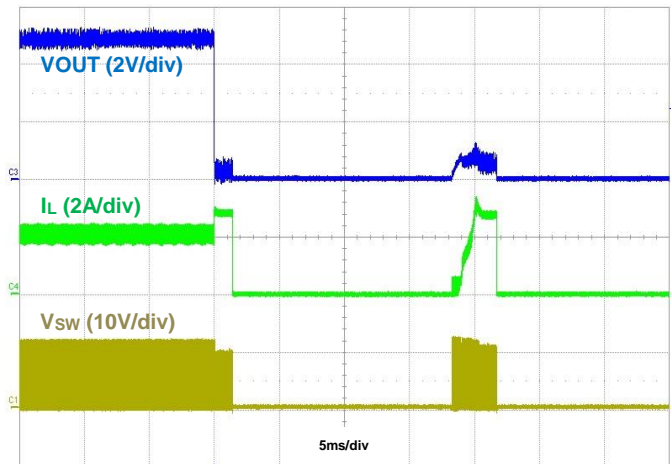

Figure 13. Output Short Protection, IOUT = 2A

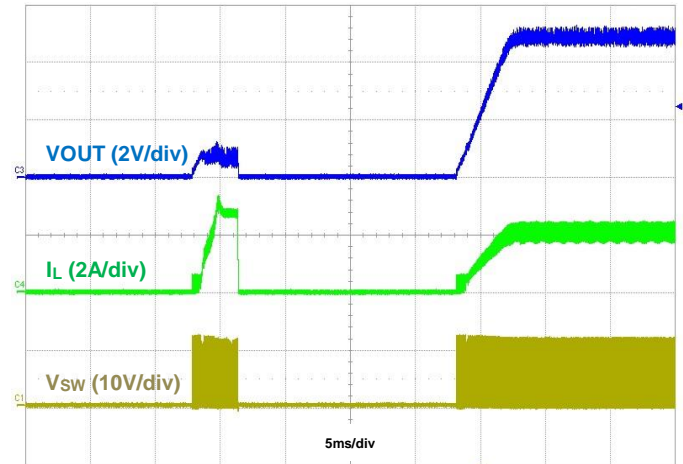

Figure 14. Output Short Recovery, IOUT = 2A

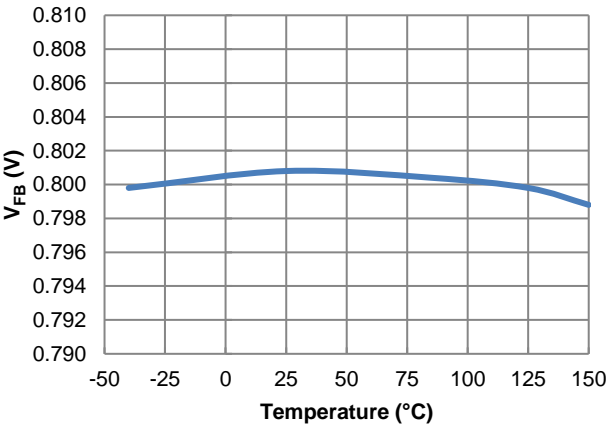

Figure 15. Feedback Voltage vs. Temperature, IOUT = 1A

**Typical Performance Characteristics** (AP63200Q @  $T_A = +25^\circ\text{C}$ ,  $V_{IN} = 12\text{V}$ ,  $V_{OUT} = 5\text{V}$ , BOM = Table 1, unless otherwise specified.)

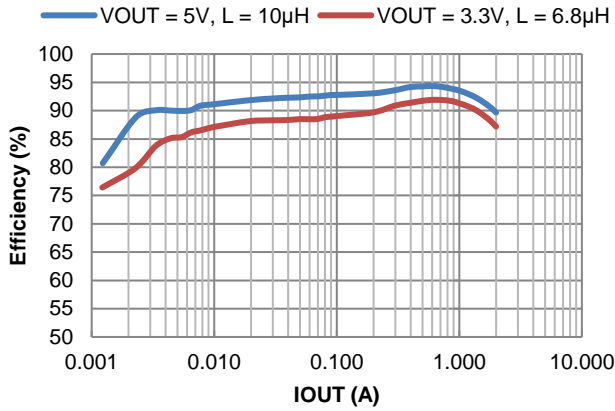

Figure 16. Efficiency vs. Output Current,  $V_{IN} = 12\text{V}$

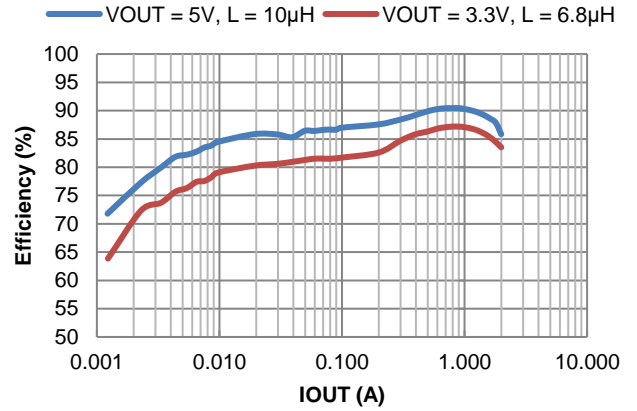

Figure 17. Efficiency vs. Output Current,  $V_{IN} = 24\text{V}$

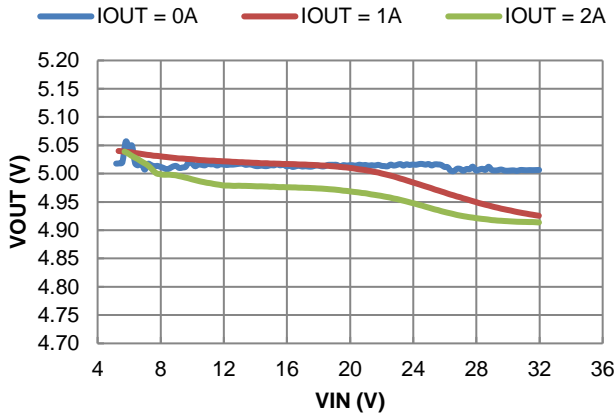

Figure 18. Line Regulation

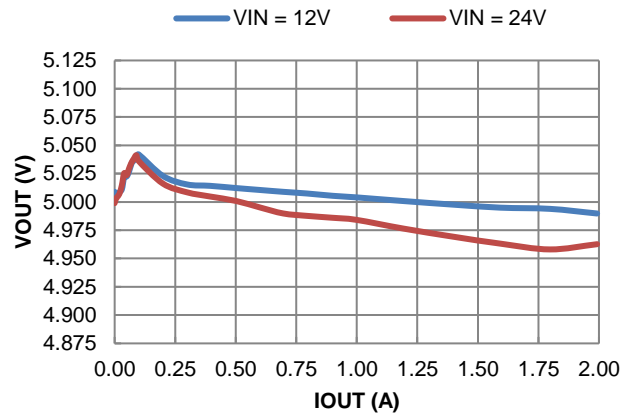

Figure 19. Load Regulation

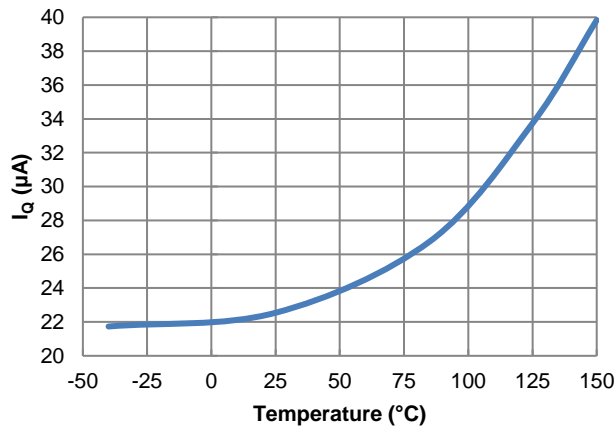

Figure 20.  $I_Q$  vs. Temperature

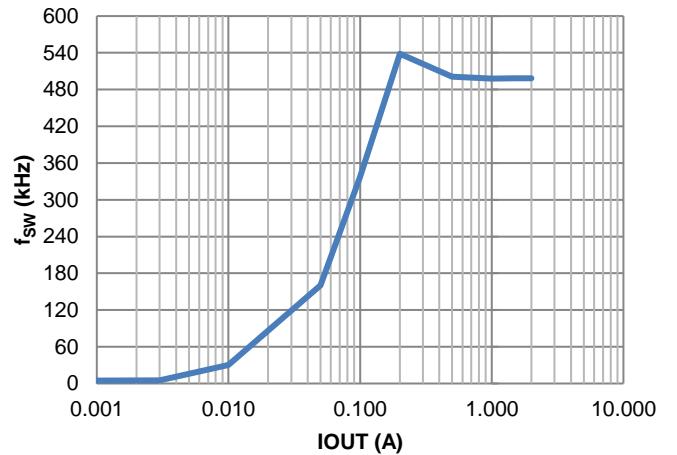

Figure 21.  $f_{sw}$  vs. Load

**Typical Performance Characteristics** (AP63200Q @  $T_A = +25^\circ\text{C}$ ,  $V_{IN} = 12\text{V}$ ,  $V_{OUT} = 5\text{V}$ , BOM = Table 1, unless otherwise specified.) (continued)

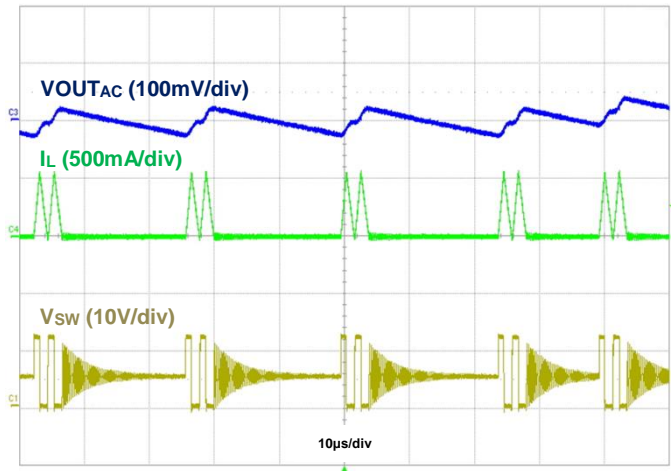

Figure 22. Output Voltage Ripple,  $V_{OUT} = 5\text{V}$ ,  $I_{OUT} = 50\text{mA}$

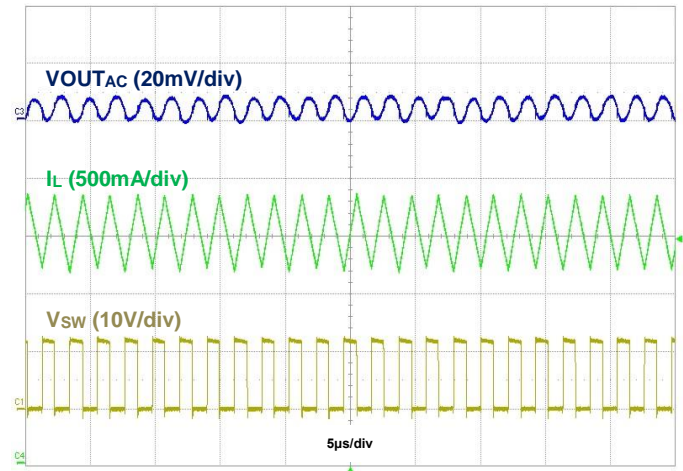

Figure 23. Output Voltage Ripple,  $V_{OUT} = 5\text{V}$ ,  $I_{OUT} = 2\text{A}$

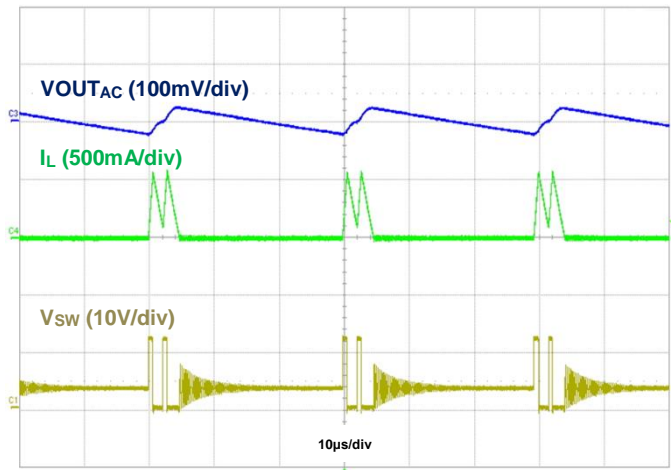

Figure 24. Output Voltage Ripple,  $V_{OUT} = 3.3\text{V}$ ,  $I_{OUT} = 50\text{mA}$

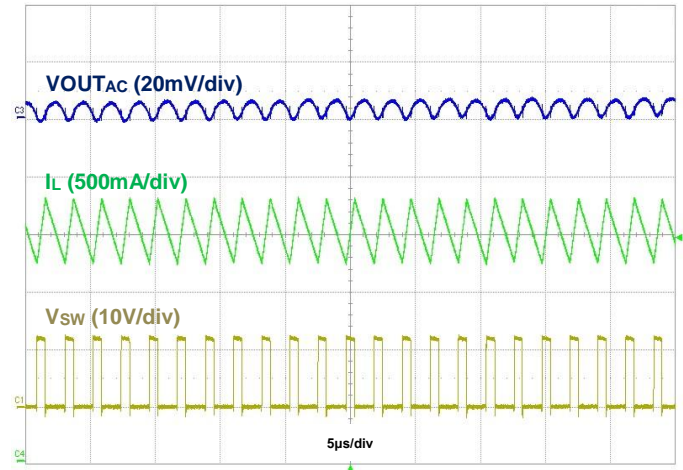

Figure 25. Output Voltage Ripple,  $V_{OUT} = 3.3\text{V}$ ,  $I_{OUT} = 2\text{A}$

**Typical Performance Characteristics** (AP63200Q @  $T_A = +25^\circ\text{C}$ ,  $V_{IN} = 12\text{V}$ ,  $V_{OUT} = 5\text{V}$ , BOM = Table 1, unless otherwise specified.) (continued)

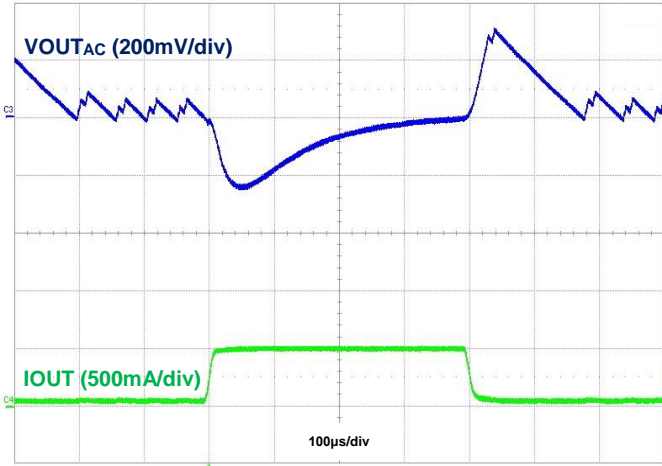

Figure 26. Load Transient, IOUT = 50mA to 500mA to 50mA

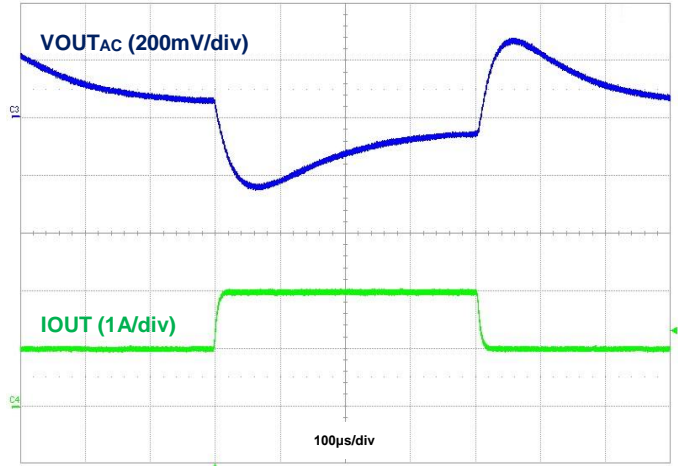

Figure 27. Load Transient, IOUT = 1A to 2A to 1A

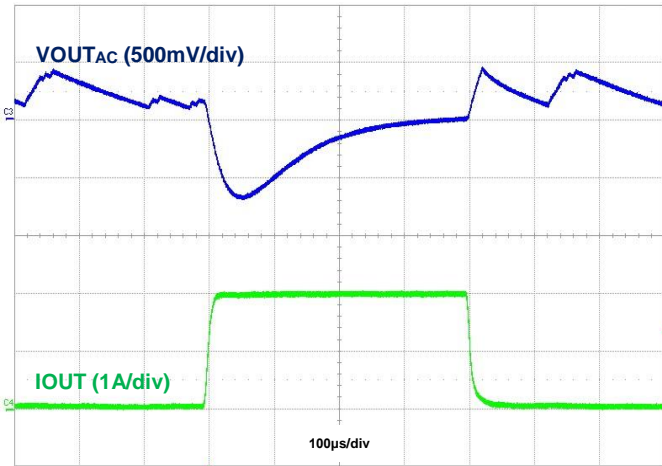

Figure 28. Load Transient, IOUT = 50mA to 2A to 50mA

**Typical Performance Characteristics** (AP63201Q @  $T_A = +25^\circ\text{C}$ ,  $V_{IN} = 12\text{V}$ ,  $V_{OUT} = 5\text{V}$ , BOM = Table 1, unless otherwise specified.)

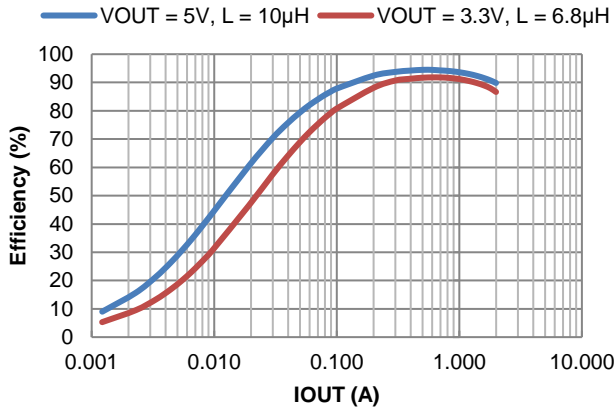

Figure 29. Efficiency vs. Output Current,  $V_{IN} = 12\text{V}$

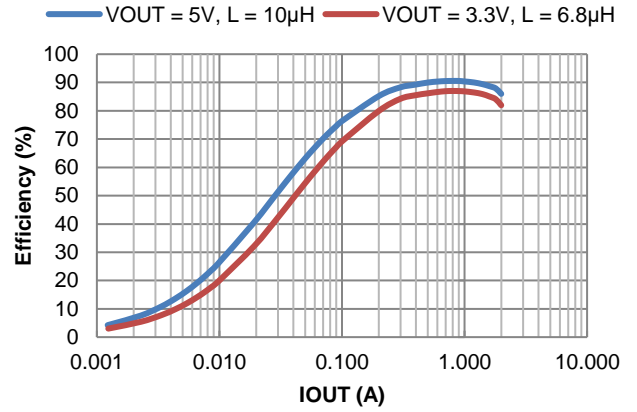

Figure 30. Efficiency vs. Output Current,  $V_{IN} = 24\text{V}$

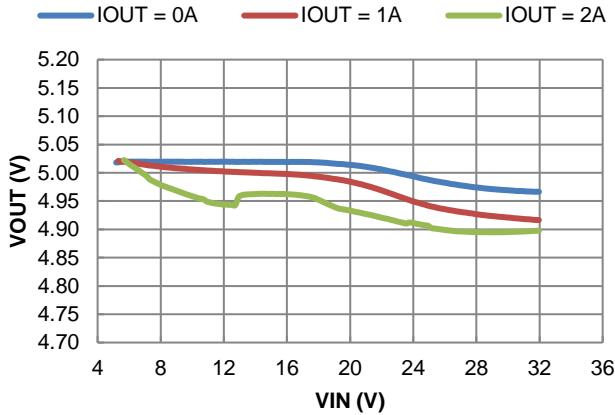

Figure 31. Line Regulation

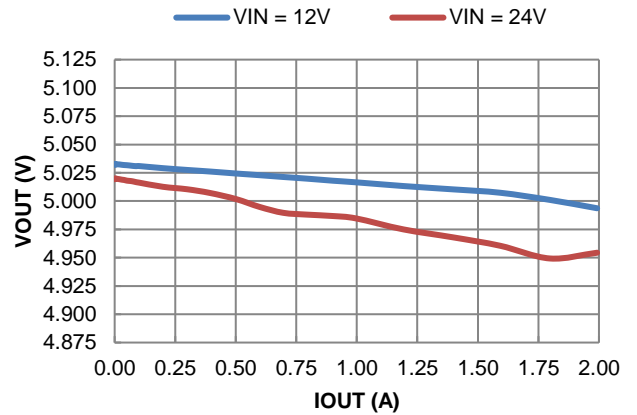

Figure 32. Load Regulation

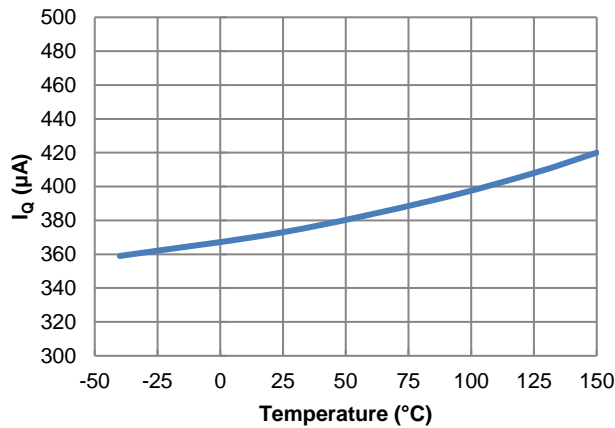

Figure 33.  $I_Q$  vs. Temperature

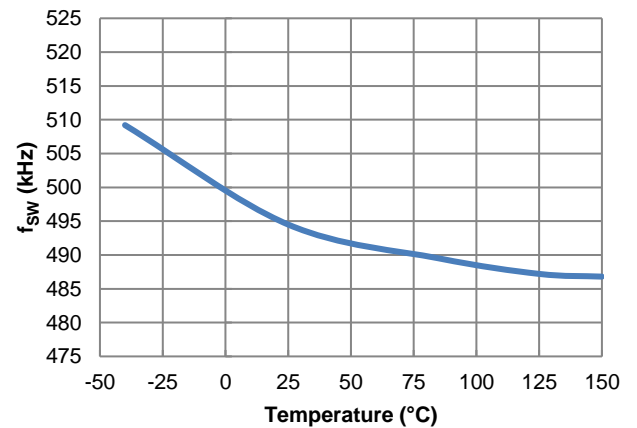
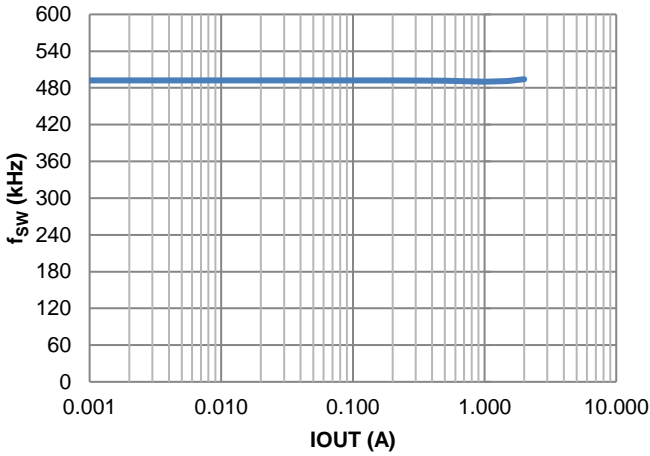
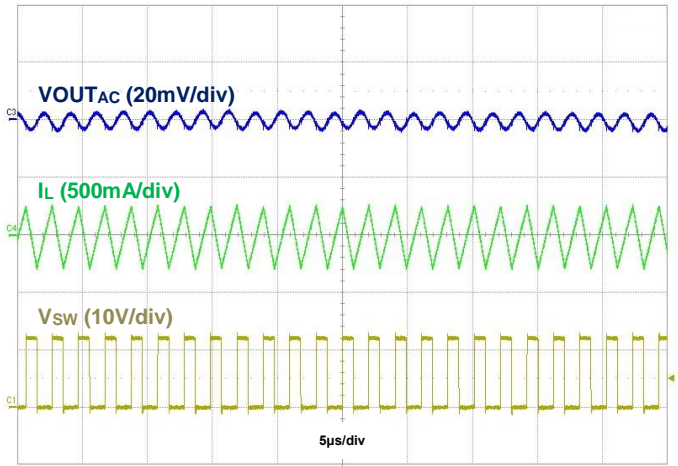

Figure 34.  $f_{sw}$  vs. Temperature,  $I_{OUT} = 0\text{A}$

**Typical Performance Characteristics** (AP63201Q @  $T_A = +25^\circ\text{C}$ ,  $V_{IN} = 12\text{V}$ ,  $V_{OUT} = 5\text{V}$ , BOM = Table 1, unless otherwise specified.) (continued)



**Figure 35.  $f_{sw}$  vs. Load**



**Figure 36. Output Voltage Ripple,  $V_{OUT} = 5\text{V}$ ,  $I_{OUT} = 50\text{mA}$**

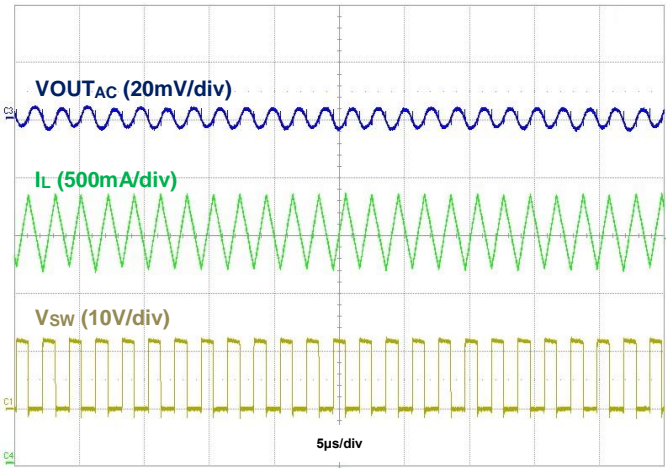

**Figure 37. Output Voltage Ripple,  $V_{OUT} = 5\text{V}$ ,  $I_{OUT} = 2\text{A}$**

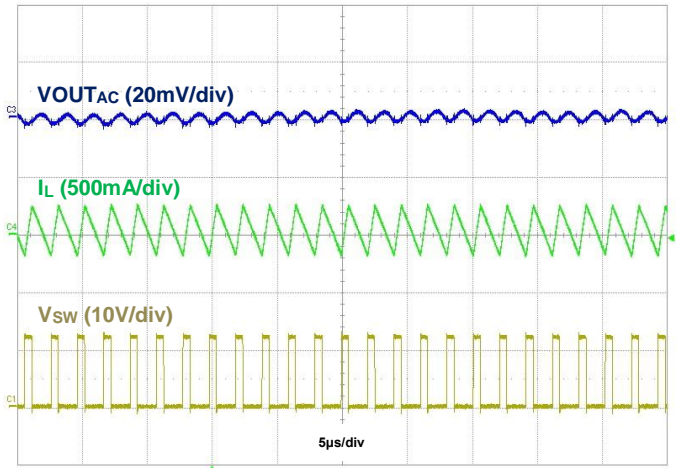

**Figure 38. Output Voltage Ripple,  $V_{OUT} = 3.3\text{V}$ ,  $I_{OUT} = 50\text{mA}$**

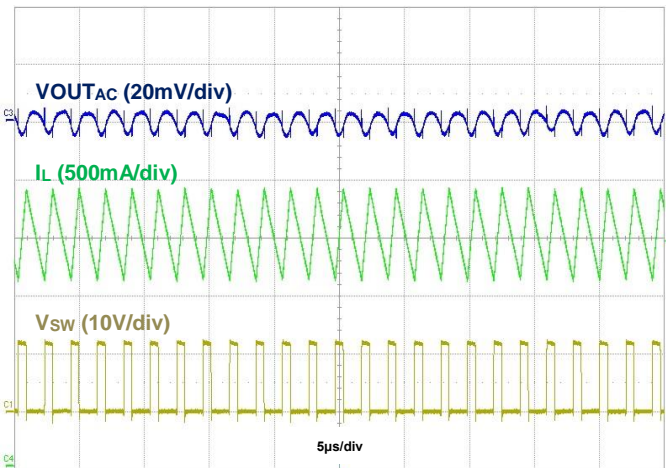

**Figure 39. Output Voltage Ripple,  $V_{OUT} = 3.3\text{V}$ ,  $I_{OUT} = 2\text{A}$**

**Typical Performance Characteristics** (AP63201Q @  $T_A = +25^\circ\text{C}$ ,  $V_{IN} = 12\text{V}$ ,  $V_{OUT} = 5\text{V}$ , BOM = Table 1, unless otherwise specified.) (continued)

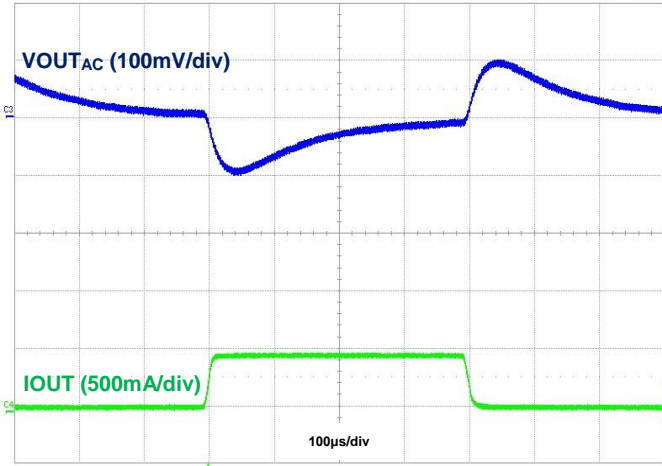

Figure 40. Load Transient, IOUT = 50mA to 500mA to 50mA

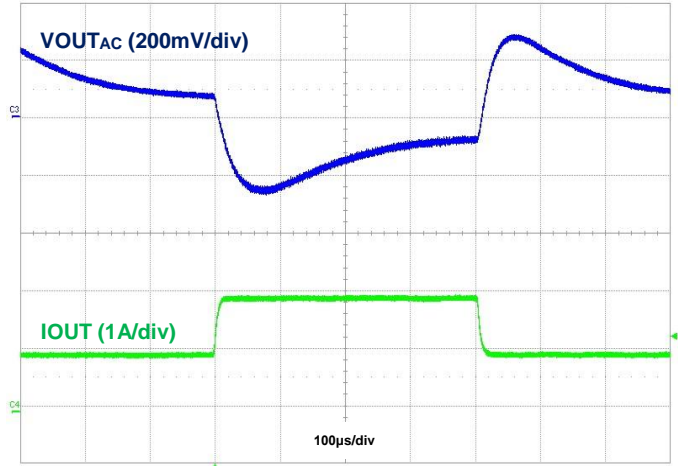

Figure 41. Load Transient, IOUT = 1A to 2A to 1A

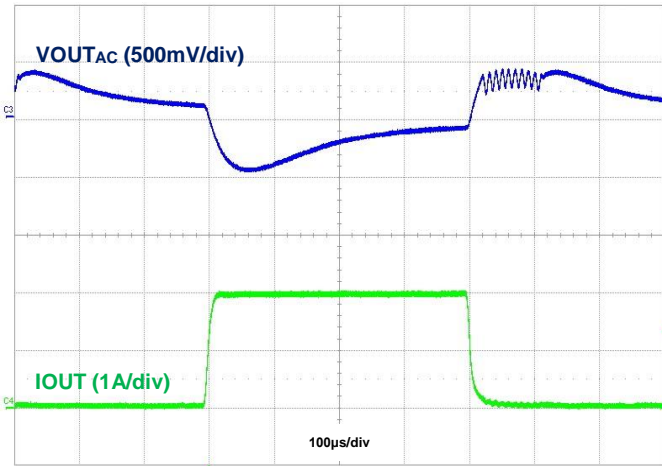

Figure 42. Load Transient, IOUT = 50mA to 2A to 50mA

**Typical Performance Characteristics** (AP63203Q @  $T_A = +25^\circ\text{C}$ ,  $V_{IN} = 12\text{V}$ ,  $V_{OUT} = 3.3\text{V}$ , BOM = Table 2, unless otherwise specified.)

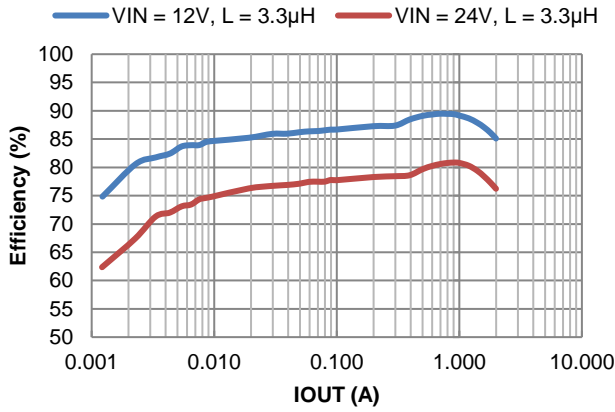

Figure 43. Efficiency vs. Output Current

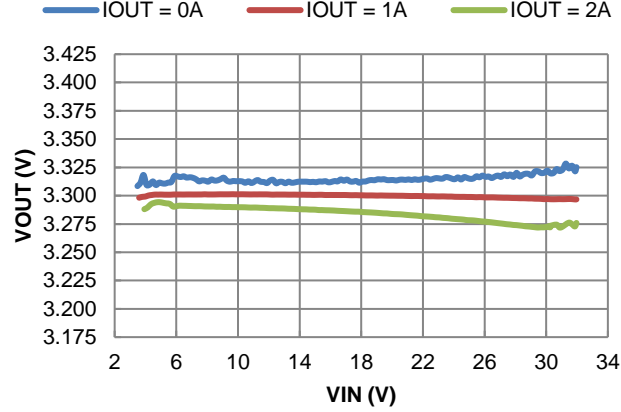

Figure 44. Line Regulation

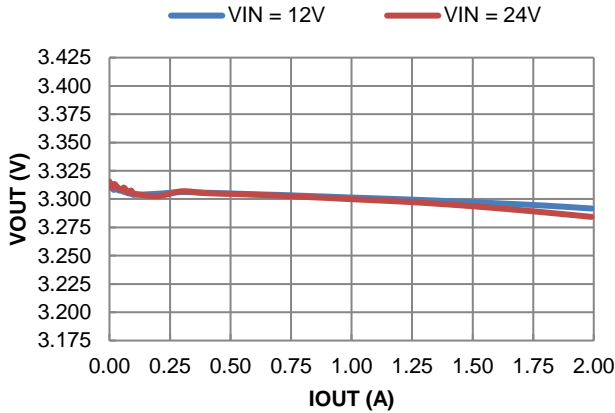

Figure 45. Load Regulation

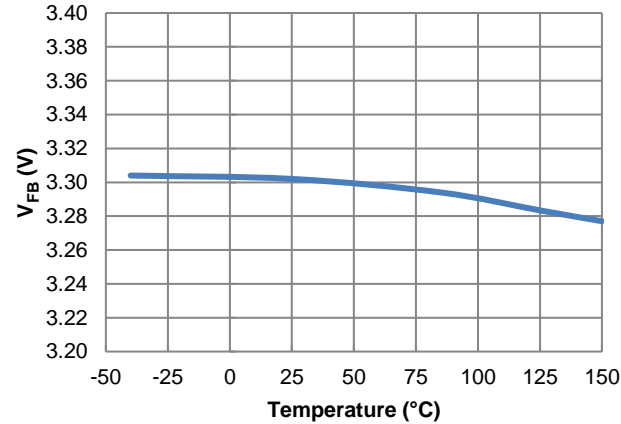

Figure 46. Feedback Voltage vs. Temperature, IOUT = 1A

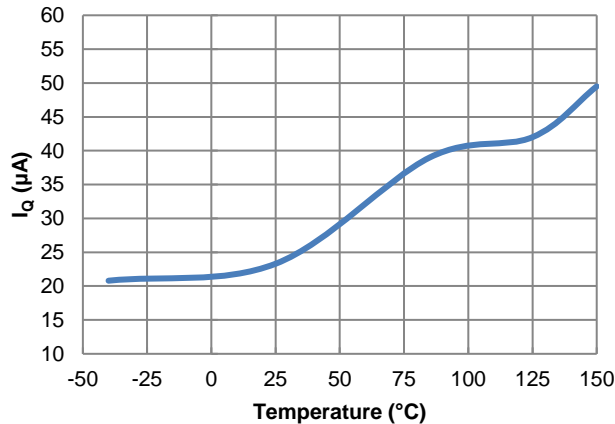

Figure 47.  $I_Q$  vs. Temperature

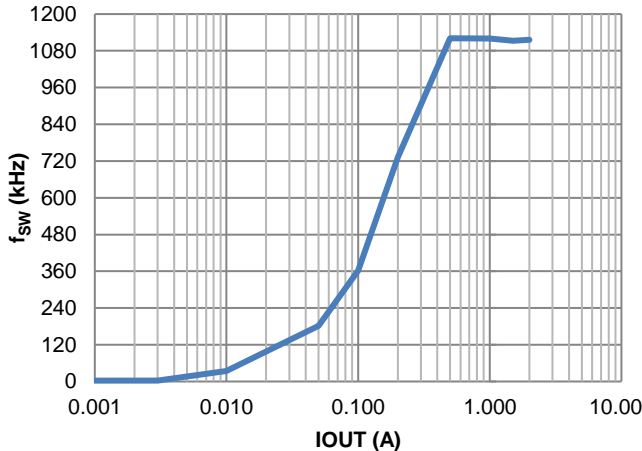

Figure 48.  $f_{sw}$  vs. Load

**Typical Performance Characteristics** (AP63203Q @  $T_A = +25^\circ\text{C}$ ,  $V_{IN} = 12\text{V}$ ,  $V_{OUT} = 3.3\text{V}$ , BOM = Table 2, unless otherwise specified.) (continued)

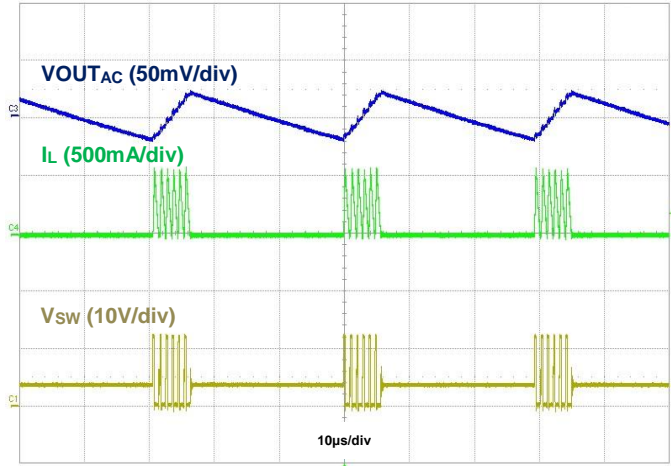

Figure 49. Output Voltage Ripple,  $I_{OUT} = 50\text{mA}$

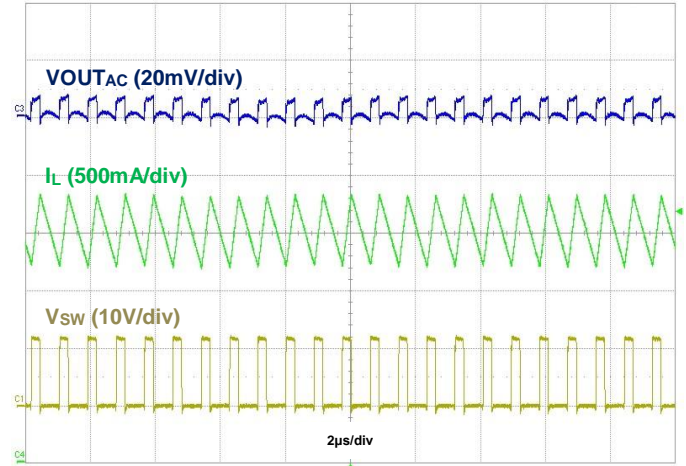

Figure 50. Output Voltage Ripple,  $I_{OUT} = 2\text{A}$

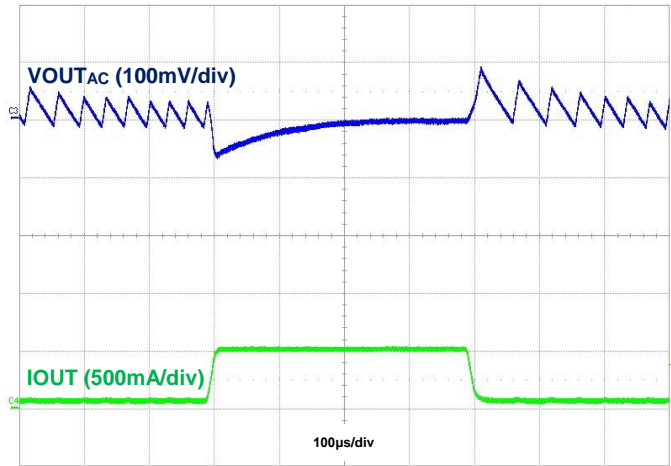

Figure 51. Load Transient,  $I_{OUT} = 50\text{mA}$  to 500mA to 50mA

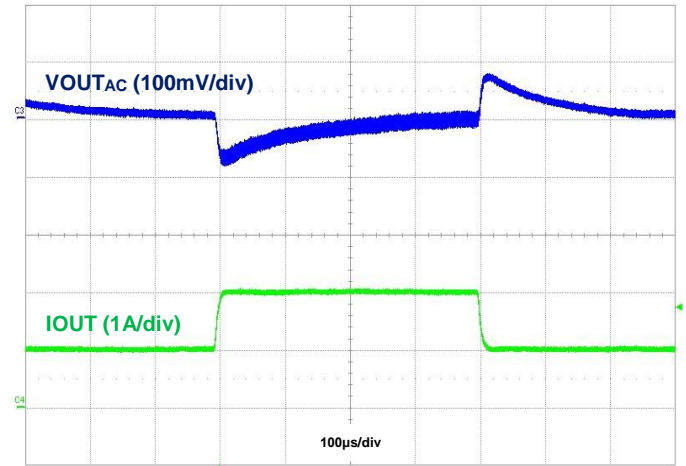

Figure 52. Load Transient,  $I_{OUT} = 1\text{A}$  to 2A to 1A

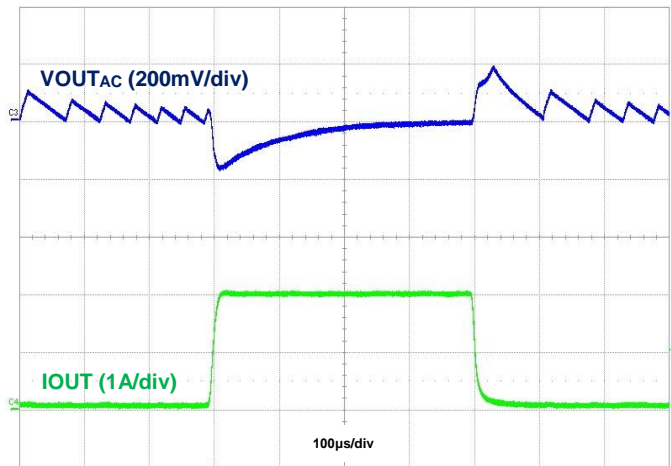

Figure 53. Load Transient,  $I_{OUT} = 50\text{mA}$  to 2A to 50mA

**Typical Performance Characteristics** (AP63203Q @  $T_A = +25^\circ\text{C}$ ,  $V_{IN} = 12\text{V}$ ,  $V_{OUT} = 3.3\text{V}$ , BOM = Table 2, unless otherwise specified.) (continued)

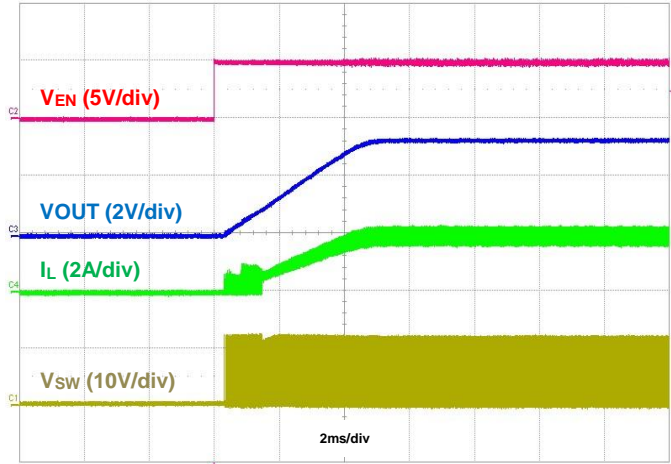

Figure 54. Startup using EN, IOU = 2A

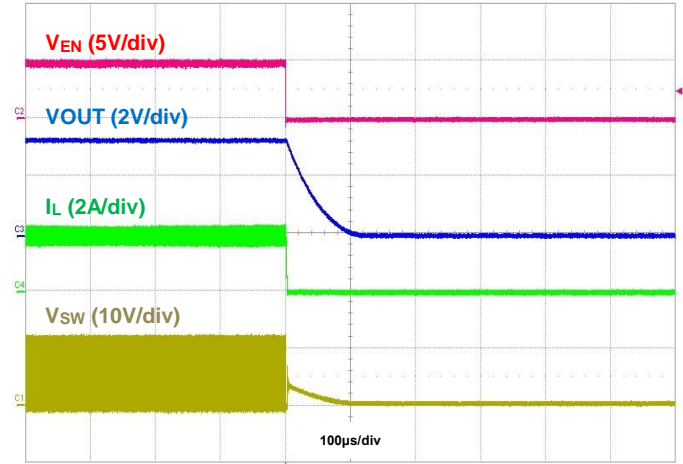

Figure 55. Shutdown using EN, IOU = 2A

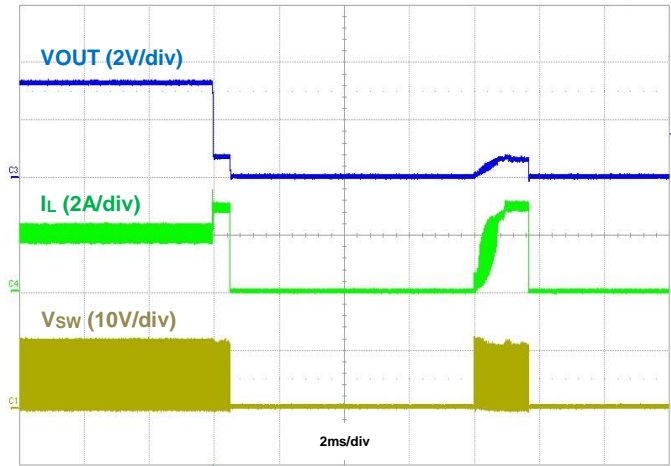

Figure 56. Output Short Protection, IOU = 2A

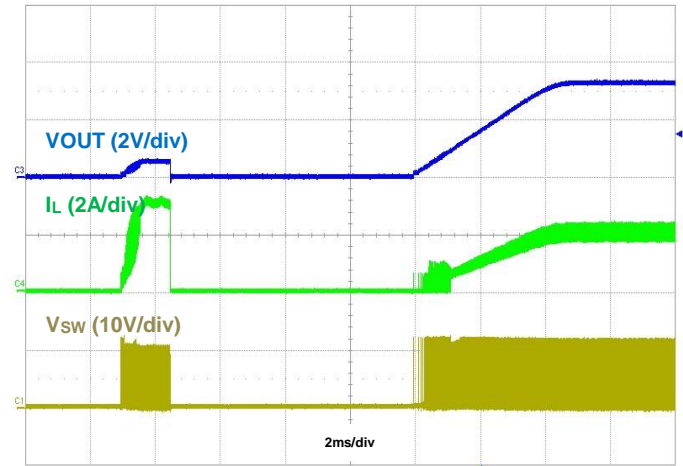

Figure 57. Output Short Recovery, IOU = 2A

**Typical Performance Characteristics** (AP63205Q @  $T_A = +25^\circ\text{C}$ ,  $V_{IN} = 12\text{V}$ ,  $V_{OUT} = 5\text{V}$ , BOM = Table 3, unless otherwise specified.)

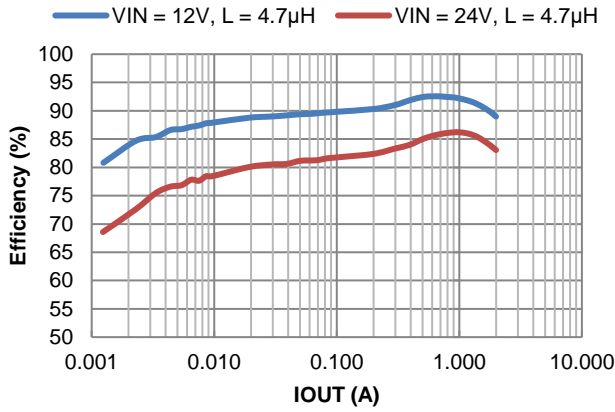

Figure 58. Efficiency vs. Output Current

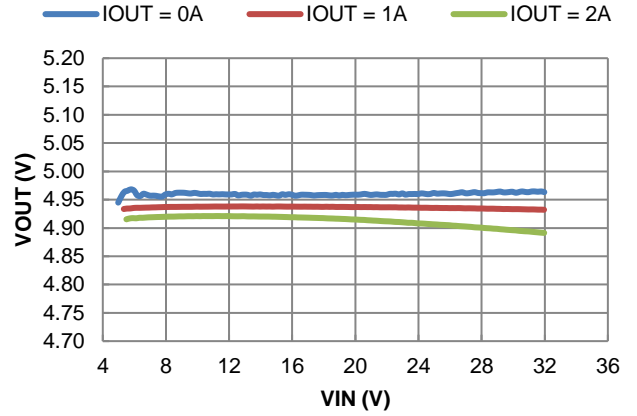

Figure 59. Line Regulation

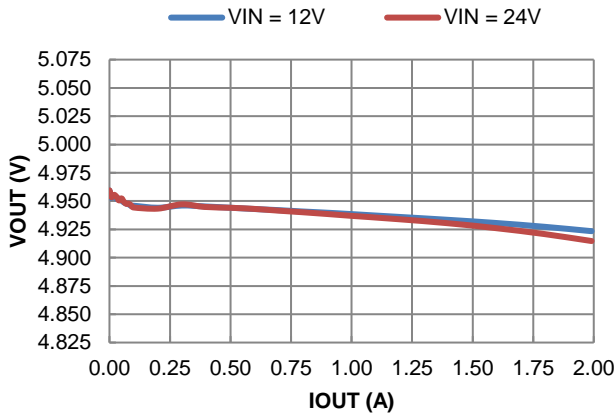

Figure 60. Load Regulation

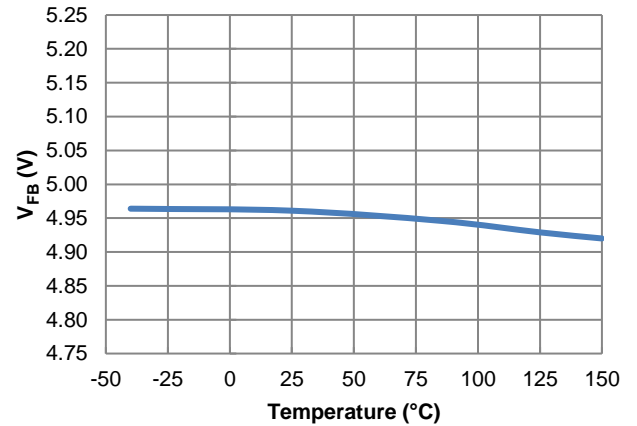

Figure 61. Feedback Voltage vs. Temperature, IOUT = 1A

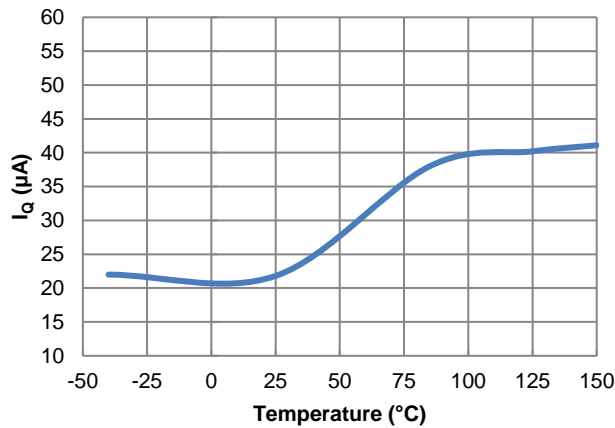

Figure 62. IQ vs. Temperature

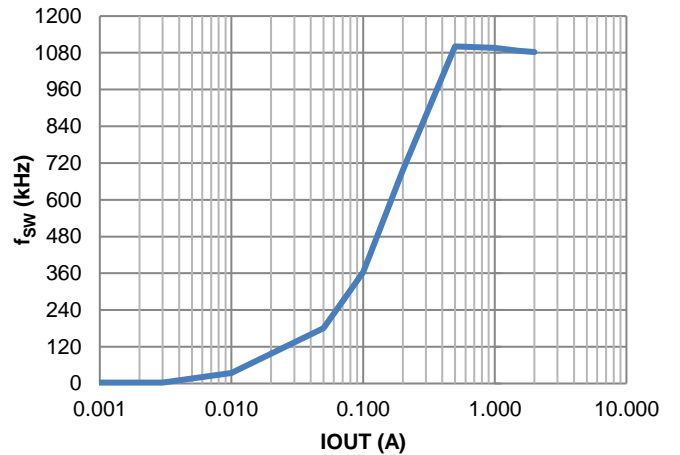

Figure 63. fsw vs. Load

**Typical Performance Characteristics** (AP63205Q @  $T_A = +25^\circ\text{C}$ ,  $V_{IN} = 12\text{V}$ ,  $V_{OUT} = 5\text{V}$ , BOM = Table 3, unless otherwise specified.) (continued)

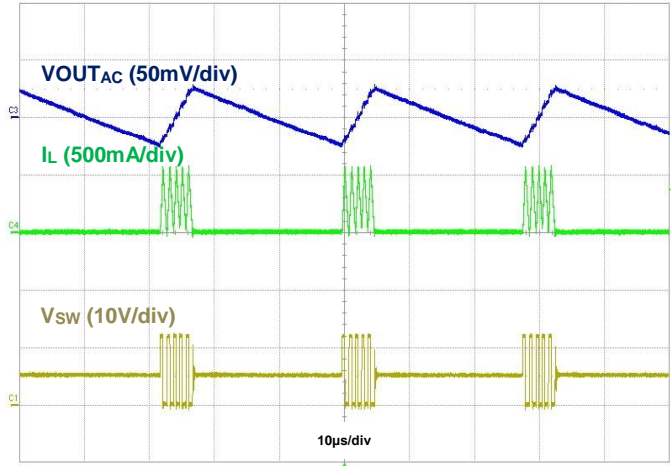

Figure 64. Output Voltage Ripple,  $I_{OUT} = 50\text{mA}$

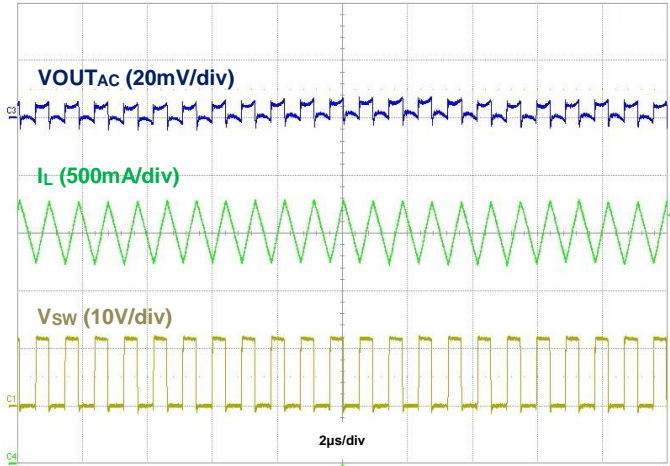

Figure 65. Output Voltage Ripple,  $I_{OUT} = 2\text{A}$

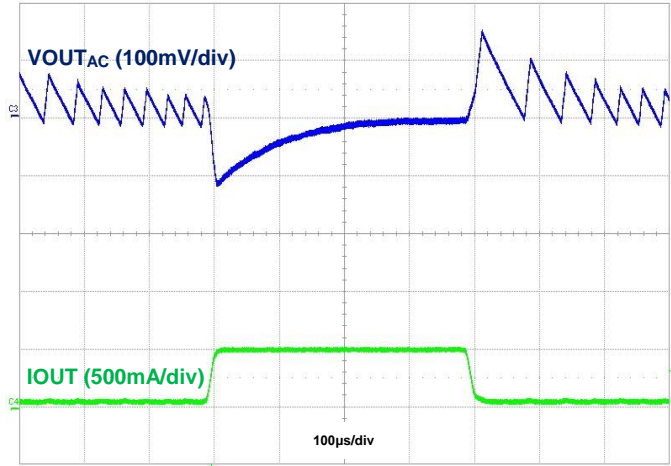

Figure 66. Load Transient,  $I_{OUT} = 50\text{mA}$  to  $500\text{mA}$  to  $50\text{mA}$

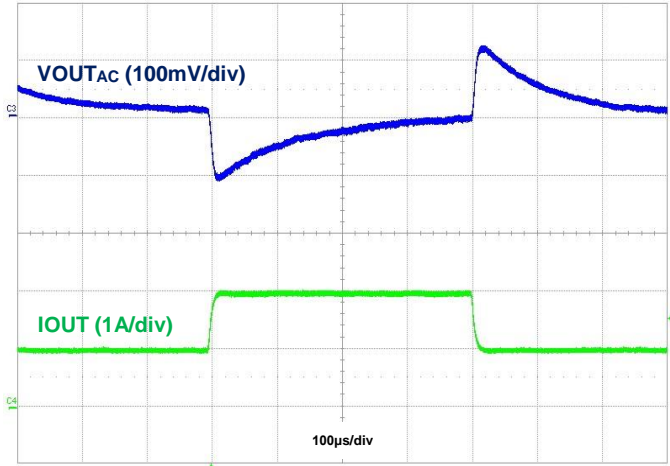

Figure 67. Load Transient,  $I_{OUT} = 1\text{A}$  to  $2\text{A}$  to  $1\text{A}$

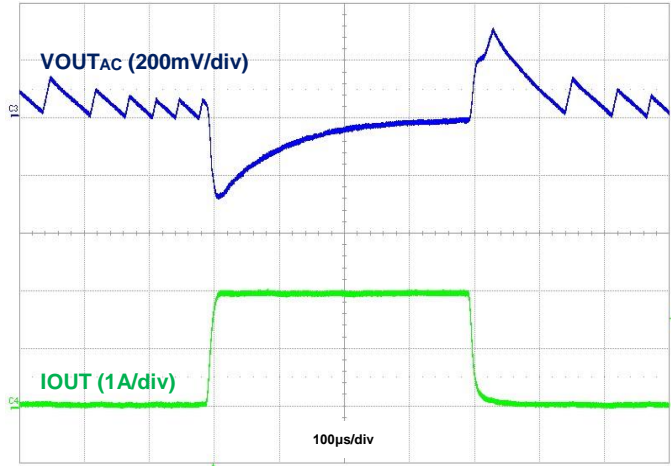

Figure 68. Load Transient,  $I_{OUT} = 50\text{mA}$  to  $2\text{A}$  to  $50\text{mA}$

**Typical Performance Characteristics** (AP63205Q @  $T_A = +25^\circ\text{C}$ ,  $V_{IN} = 12\text{V}$ ,  $V_{OUT} = 5\text{V}$ , BOM = Table 3, unless otherwise specified.) (continued)

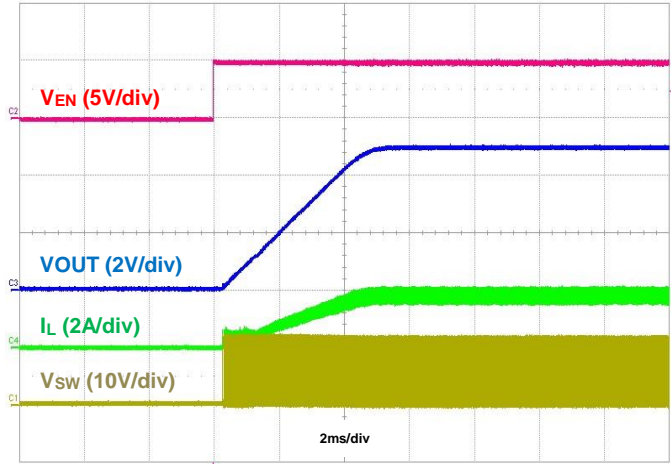

Figure 69. Startup using EN, IOU = 2A

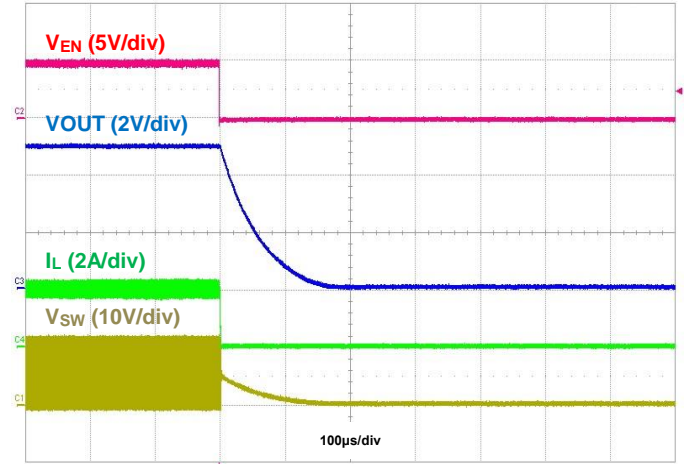

Figure 70. Shutdown using EN, IOU = 2A

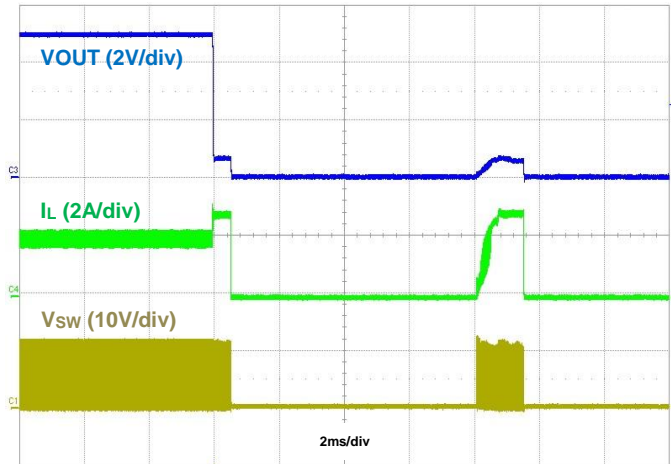

Figure 71. Output Short Protection, IOU = 2A

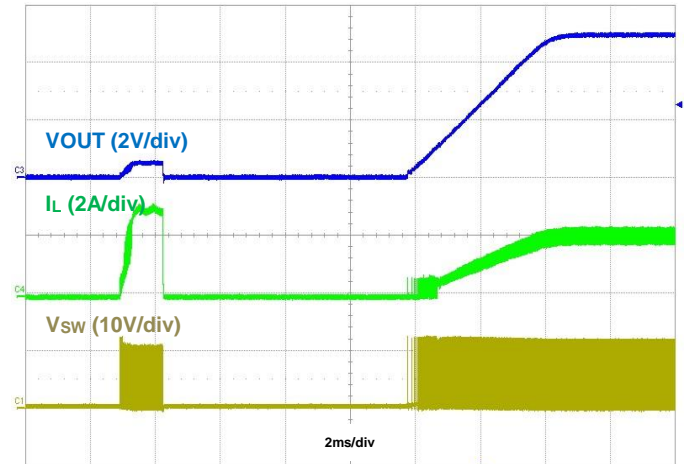

Figure 72. Output Short Recovery, IOU = 2A

## Application Information

### 1 Pulse Width Modulation (PWM) Operation

The AP63200Q/AP63201Q/AP63203Q/AP63205Q device is an automotive-compliant, 3.8V-to-32V input, 2A output, EMI friendly, fully integrated synchronous buck converter. Refer to the block diagram in Figure 7. The device employs fixed-frequency peak current mode control. The internal clock's rising edge (500kHz for AP63200Q/AP63201Q, 1100kHz for AP63203Q/AP63205Q) initiates turning on the integrated high-side power MOSFET, Q1, for each cycle. When Q1 is on, the inductor current rises linearly and the device charges the output capacitor. The current across Q1 is sensed and converted to a voltage with a ratio of  $R_T$  via the CSA block. The CSA output is combined with an internal slope compensation,  $S_E$ , resulting in  $V_{SUM}$ . When  $V_{SUM}$  rises higher than the COMP node, the device turns off Q1 and turns on the low-side power MOSFET, Q2. The inductor current decreases when Q2 is on. On the rising edge of next clock cycle, Q2 turns off and Q1 turns on. This sequence repeats every clock cycle.

The error amplifier generates the COMP voltage by comparing the voltage on the FB pin with an internal 0.8V reference. An increase in load current causes the feedback voltage to drop. The error amplifier thus raises the COMP voltage until the average inductor current matches the increased load current. This feedback loop regulates the output voltage. The internal slope compensation circuitry prevents subharmonic oscillation when the duty cycle is greater than 50% for peak current mode control.

The peak current mode control, integrated loop compensation network, and built-in 4ms soft-start time simplifies the AP63200Q/AP63201Q/AP63203Q/AP63205Q footprint as well as minimizes the external component count.

In order to provide a small output ripple during light load conditions, the AP63201Q operates in PWM regardless of output load.

### 2 Pulse Frequency Modulation (PFM) Operation

In heavy load conditions, the AP63200Q/AP63203Q/AP63205Q operates in forced PWM mode. As the load current decreases, the internal COMP node voltage also decreases. At a certain limit, if the load current is low enough, the COMP node voltage is clamped and is prevented from decreasing any further. The voltage at which COMP is clamped corresponds to the 600mA PFM peak inductor current limit. As the load current approaches zero, the AP63200Q/AP63203Q/AP63205Q enters PFM mode to increase the converter power efficiency at light load conditions. When the inductor current decreases to 50mA, zero cross detection circuitry on the low-side power MOSFET, Q2, forces it off. The buck converter does not sink current from the output when the output load is light and while the device is in PFM. Because the AP63200Q/AP63203Q/AP63205Q works in PFM during light load conditions, it can achieve power efficiency of up to 88% at a 5mA load condition.

The quiescent current of AP63200Q/AP63203Q/AP63205Q is 22µA typical under a no-load, non-switching condition.

### 3 Enable

When disabled, the device shutdown supply current is only 1µA. When applying a voltage greater than the EN logic high threshold (typical 1.18V, rising), the AP63200Q/AP63201Q/AP63203Q/AP63205Q enables all functions and the device initiates the soft-start phase. The EN pin is a high-voltage pin and can be directly connected to VIN to automatically start up the device as VIN increases. An internal 1.5µA pull-up current source connected from the internal LDO-regulated VCC to the EN pin guarantees that if EN is left floating, the device still automatically enables once the voltage reaches the EN logic high threshold. The AP63200Q/AP63201Q/AP63203Q/AP63205Q has a built-in 4ms soft-start time to prevent output voltage overshoot and inrush current. When the EN voltage falls below its logic low threshold (typical 1.09V, falling), the internal SS voltage discharges to ground and device operation disables.

The EN pin can also be used to adjust the undervoltage lockout thresholds. See **Undervoltage Lockout (UVLO)** section for more details.

Alternatively, a small ceramic capacitor can be added from EN to GND. When EN is not driven externally, this capacitor increases the time needed for the EN pin voltage to reach its logic high threshold, which delays the startup of the output voltage. This is useful when sequencing multiple power rails to minimize input inrush current. When the EN pin voltage starts from 0V, the amount of capacitance for a given delay time is approximated by:

$$C_d[\text{nF}] \approx 1.27 \cdot t_d[\text{ms}] \tag{Eq. 1}$$

Where:

- $C_d$  is the time delay capacitance in nF
- $t_d$  is the delay time in ms

**Application Information** (continued)

**4 Electromagnetic Interference (EMI) Reduction with Ringing-Free Switching Node and Frequency Spread Spectrum (FSS)**

In some applications, the system must meet EMI standards. In relation to high frequency radiation EMI noise, the switching node's (SW's) ringing amplitude is especially critical. To dampen high frequency radiated EMI noise, the AP63200Q/AP63201Q/AP63203Q/AP63205Q device implements a proprietary, multi-level gate driver scheme that achieves a ringing-free switching node without sacrificing the switching node's rise and fall slew rates as well as the converter's power efficiency.

To further improve EMI reduction, the AP63200Q/AP63203Q/AP63205Q device also implements FSS with a switching frequency jitter of  $\pm 6\%$ . FSS reduces conducted and radiated interference at a particular frequency by spreading the switching noise over a wider frequency band and by not allowing emitted energy to stay in any one frequency for a significant period of time.

Additionally, the fixed output voltage devices, AP63203Q and AP63205Q, remove resonance ringing of the SW pin while in PFM mode when the inductor current is 0A. See Figure 73 for an example waveform.

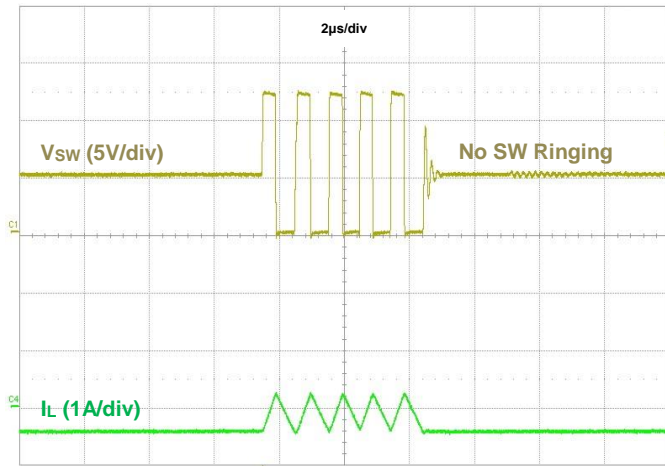

Figure 73. AP63203Q/AP63205Q SW Pin Waveform

**5 Adjusting Undervoltage Lockout (UVLO)**

Undervoltage lockout is implemented to prevent the IC from insufficient input voltages. The AP63200Q/AP63201Q/AP63203Q/AP63205Q device has a UVLO comparator that monitors the input voltage and the internal bandgap reference. The AP63200Q/AP63201Q/AP63203Q/AP63205Q disables if the input voltage falls below 3.06V. In this UVLO event, both the high-side and low-side power MOSFETs turn off.

Some applications may desire higher VIN UVLO threshold voltages than is provided by the default setup. A 4µA hysteresis pull-up current source on the EN pin along with an external resistive divider (R3 and R4) configures the VIN UVLO threshold voltages as shown in Figure 74.

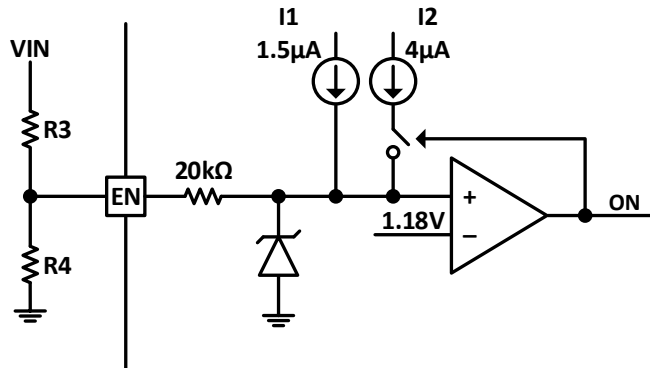

Figure 74. Adjusting UVLO

## Application Information (continued)

### 5 Adjusting Undervoltage Lockout (UVLO) (continued)

The resistive divider resistor values are calculated by:

$$R3 = \frac{0.924 \cdot V_{ON} - V_{OFF}}{4.114\mu A} \quad \text{Eq. 2}$$

$$R4 = \frac{1.09 \cdot R3}{V_{OFF} - 1.09V + 5.5\mu A \cdot R3} \quad \text{Eq. 3}$$

Where:

- $V_{ON}$  is the rising edge VIN voltage to enable the regulator and is greater than 3.7V
- $V_{OFF}$  is the falling edge VIN voltage to disable the regulator and is greater than 3.26V

### 6 Output Overvoltage Protection (OVP)

The AP63200Q/AP63201Q/AP63203Q/AP63205Q implements output OVP circuitry to minimize output voltage overshoots during decreasing load transients. The high-side power MOSFET turns off, and the low-side power MOSFET turns on, when the feedback voltage exceeds 110% of the 0.8V internal reference voltage in order to prevent the output voltage from continuing to increase.

### 7 Overcurrent Protection (OCP)

The AP63200Q/AP63201Q/AP63203Q/AP63205Q has cycle-by-cycle peak current limit protection by sensing the current through the internal high-side power MOSFET, Q1. While Q1 is on, the internal sensing circuitry monitors its conduction current. Once the current through Q1 exceeds the peak current limit, Q1 immediately turns off. If Q1 consistently hits the peak current limit for 512 cycles, the buck converter enters hiccup mode and shuts down. After 8192 cycles of down time, the buck converter restarts powering up. Hiccup mode reduces the power dissipation in the overcurrent condition.

### 8 Thermal Shutdown (TSD)

If the junction temperature of the device reaches the thermal shutdown limit of +160°C, the AP63200Q/AP63201Q/AP63203Q/AP63205Q shuts down both its high-side and low-side power MOSFETs. When the junction temperature reduces to the required level (+135°C typical), the device initiates a normal power-up cycle with soft-start.

### 9 Power Derating Characteristics

To prevent the regulator from exceeding the maximum recommended operating junction temperature, some thermal analysis is required. The regulator's temperature rise is given by:

$$T_{RISE} = PD \cdot (\theta_{JA}) \quad \text{Eq. 4}$$

Where:

- PD is the power dissipated by the regulator
- $\theta_{JA}$  is the thermal resistance from the junction of the die to the ambient temperature

The junction temperature,  $T_J$ , is given by:

$$T_J = T_A + T_{RISE} \quad \text{Eq. 5}$$

Where:

- $T_A$  is the ambient temperature of the environment

**Application Information** (continued)

**9 Power Derating Characteristics (continued)**

For the TSOT26 package, the  $\theta_{JA}$  is 89°C/W. The actual junction temperature should not exceed the maximum recommended operating junction temperature of +150°C when considering the thermal design. Figure 75 and Figure 76 show typical derating curves versus ambient temperature.

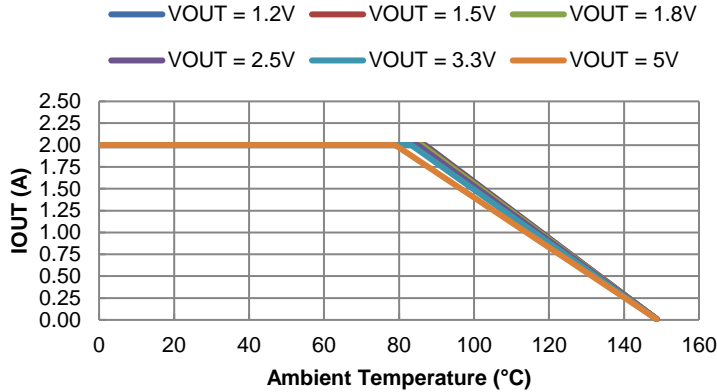

**Figure 75. Output Current Derating Curve vs. Ambient Temperature, AP63200Q/AP63201Q, VIN = 12V**

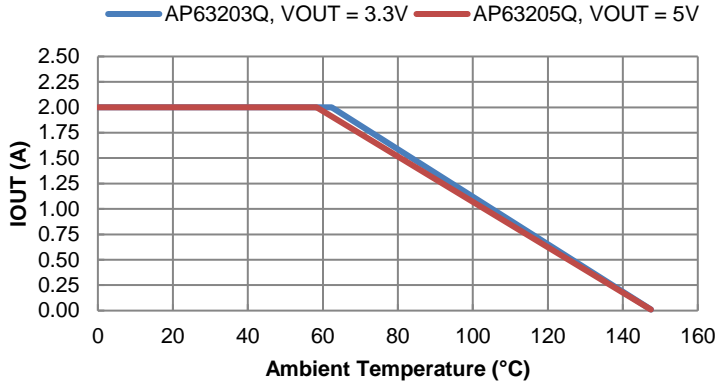

**Figure 76. Output Current Derating Curve vs. Ambient Temperature, AP63203Q/AP63205Q, VIN = 12V**

**10 Setting the Output Voltage**

The AP63200Q/AP63201Q has adjustable output voltages starting from 0.8V using an external resistive divider. An optional external capacitor, C4 in Figure 1, of 10pF to 220pF improves the transient response. The resistor values of the feedback network are selected based on a design trade-off between efficiency and output voltage accuracy. There is less current consumption in the feedback network for high resistor values, which improves efficiency at light loads. However, values too high cause the device to be more susceptible to noise affecting its output voltage accuracy. R1 can be determined by the following equation:

$$R1 = R2 \cdot \left( \frac{VOUT}{0.8V} - 1 \right) \tag{Eq. 6}$$

## Application Information (continued)

### 10 Setting the Output Voltage (continued)

Table 1 shows a list of recommended component selections for common AP63200Q/AP63201Q output voltages referencing Figure 1.

**Table 1. Recommended Component Selections for AP63200Q/AP63201Q**

AP63200Q/AP63201Q							
Output Voltage (V)	R1 (kΩ)	R2 (kΩ)	L (μH)	C1 (μF)	C2 (μF)	C3 (nF)	C4 (pF)
1.2	15.0	30.1	3.3	10	3 x 22	100	100
1.5	26.1	30.1	4.7	10	3 x 22	100	100
1.8	37.4	30.1	4.7	10	2 x 22	100	100
2.5	63.4	30.1	6.8	10	2 x 22	100	100
3.3	93.1	30.1	6.8	10	2 x 22	100	100
5.0	158.0	30.1	10.0	10	2 x 22	100	100
12.0	422.0	30.1	15.0	10	2 x 22	100	56

The AP63203Q/AP63205Q has a fixed output voltage. Table 2 and Table 3 show the recommended component selections for AP63203Q and AP63205Q referencing Figure 4.

**Table 2. Recommended Component Selections for AP63203Q**

AP63203Q				
Output Voltage (V)	L (μH)	C1 (μF)	C2 (μF)	C3 (nF)
3.3	3.3	10	2 x 22	100

**Table 3. Recommended Component Selections for AP63205Q**

AP63205Q				
Output Voltage (V)	L (μH)	C1 (μF)	C2 (μF)	C3 (nF)
5.0	4.7	10	2 x 22	100

### 11 Inductor

Calculating the inductor value is a critical factor in designing a buck converter. For most designs, the following equation can be used to calculate the inductor value:

$$L = \frac{V_{OUT} \cdot (V_{IN} - V_{OUT})}{V_{IN} \cdot \Delta I_L \cdot f_{SW}} \quad \text{Eq. 7}$$

Where:

- $\Delta I_L$  is the inductor current ripple
- $f_{SW}$  is the buck converter switching frequency

For the AP63200Q/AP63201Q/AP63203Q/AP63205Q, choose  $\Delta I_L$  to be 30% to 40% of the maximum load current of 2A.

The inductor peak current is calculated by:

$$I_{LPEAK} = I_{LOAD} + \frac{\Delta I_L}{2} \quad \text{Eq. 8}$$

Peak current determines the required saturation current rating, which influences the size of the inductor. Saturating the inductor decreases the converter efficiency while increasing the temperatures of the inductor and the internal power MOSFETs. Therefore, choosing an inductor with the appropriate saturation current rating is important. For most applications, it is recommended to select an inductor of approximately 3.3μH to 15μH with a DC current rating of at least 35% higher than the maximum load current. For highest efficiency, the inductor's DC resistance should be less than 30mΩ. Use a larger inductance for improved efficiency under light load conditions.

## Application Information (continued)

### 12 Input Capacitor

The input capacitor reduces both the surge current drawn from the input supply as well as the switching noise from the device. The input capacitor must sustain the ripple current produced during the on-time of Q1. It must have a low ESR to minimize power dissipation due to the RMS input current.

The RMS current rating of the input capacitor is a critical parameter and must be higher than the RMS input current. As a rule of thumb, select an input capacitor with an RMS current rating greater than half of the maximum load current.

Due to large di/dt through the input capacitor, electrolytic or ceramic capacitors with low ESR should be used. If using a tantalum capacitor, it must be surge protected or else capacitor failure could occur. Using a ceramic capacitor of 10µF or greater is sufficient for most applications.

### 13 Output Capacitor

The output capacitor keeps the output voltage ripple small, ensures feedback loop stability, and reduces both the overshoots and undershoots of the output voltage during load transients. During the first few microseconds of an increasing load transient, the converter recognizes the change from steady-state and enters 100% duty cycle to supply more current to the load. However, the inductor limits the change to increasing current depending on its inductance. Therefore, the output capacitor supplies the difference in current to the load during this time. Likewise, during the first few microseconds of a decreasing load transient, the converter recognizes the change from steady-state and sets the on-time to minimum to reduce the current supplied to the load. However, the inductor limits the change in decreasing current as well. Therefore, the output capacitor absorbs the excess current from the inductor during this time.

The effective output capacitance, COUT, requirements can be calculated from the equations below.

The ESR of the output capacitor dominates the output voltage ripple. The amount of ripple can be calculated by:

$$VOUT_{Ripple} = \Delta I_L \cdot \left( ESR + \frac{1}{8 \cdot f_{sw} \cdot COUT} \right) \quad \text{Eq. 9}$$

Output capacitors with large capacitance and low ESR are the best option. For most applications, a total capacitance of 2 x 22µF using ceramic capacitors is sufficient. To meet the load transient requirements, the calculated COUT should satisfy the following inequality:

$$COUT > \max \left( \frac{L \cdot I_{Trans}^2}{\Delta V_{Overshoot} \cdot VOUT}, \frac{L \cdot I_{Trans}^2}{\Delta V_{Undershoot} \cdot (VIN - VOUT)} \right) \quad \text{Eq. 10}$$

Where:

- I<sub>Trans</sub> is the load transient
- ΔV<sub>Overshoot</sub> is the maximum output overshoot voltage
- ΔV<sub>Undershoot</sub> is the maximum output undershoot voltage

### 14 Bootstrap Capacitor and Low-Dropout (LDO) Operation

To ensure proper operation, a ceramic capacitor must be connected between the BST and SW pins to supply the drive voltage for the high-side power MOSFET. A 100nF ceramic capacitor is sufficient. If the bootstrap capacitor voltage falls below 2.3V, the boot undervoltage protection circuit turns Q2 on for 220ns to refresh the bootstrap capacitor and raise its voltage back above 2.85V. The bootstrap capacitor's voltage is always maintained to ensure enough driving capability for Q1. This operation may arise during long periods of no switching such as in PFM with light load conditions. Another event that requires the refreshing of the bootstrap capacitor is when the input voltage drops close to the output voltage. Under this condition, the regulator enters low-dropout mode by holding Q1 on for multiple clock cycles. To prevent the bootstrap capacitor from discharging, Q2 is forced to refresh. The effective duty cycle is approximately 100% so that it acts as an LDO to maintain the output voltage regulation.

**Layout**

**PCB Layout**

1. The AP63200Q/AP63201Q/AP63203Q/AP63205Q works at 2A load current so heat dissipation is a major concern in the layout of the PCB. 2oz copper for both the top and bottom layers is recommended.
2. Place the input capacitors as closely across VIN and GND as possible.
3. Place the inductor as close to SW as possible.
4. Place the output capacitors as close to GND as possible.
5. Place the feedback components as close to FB as possible, if applicable. If using AP63203Q/AP63205Q, tie the FB pin directly to VOUT as there is no need for R1, R2, or C4.
6. If using four or more layers, use at least the 2<sup>nd</sup> and 3<sup>rd</sup> layers as GND to maximize thermal performance.
7. Add as many vias as possible around both the GND pin and under the GND plane for heat dissipation to all the GND layers.
8. Add as many vias as possible around both the VIN pin and under the VIN plane for heat dissipation to all the VIN layers.
9. See Figure 77 for more details.

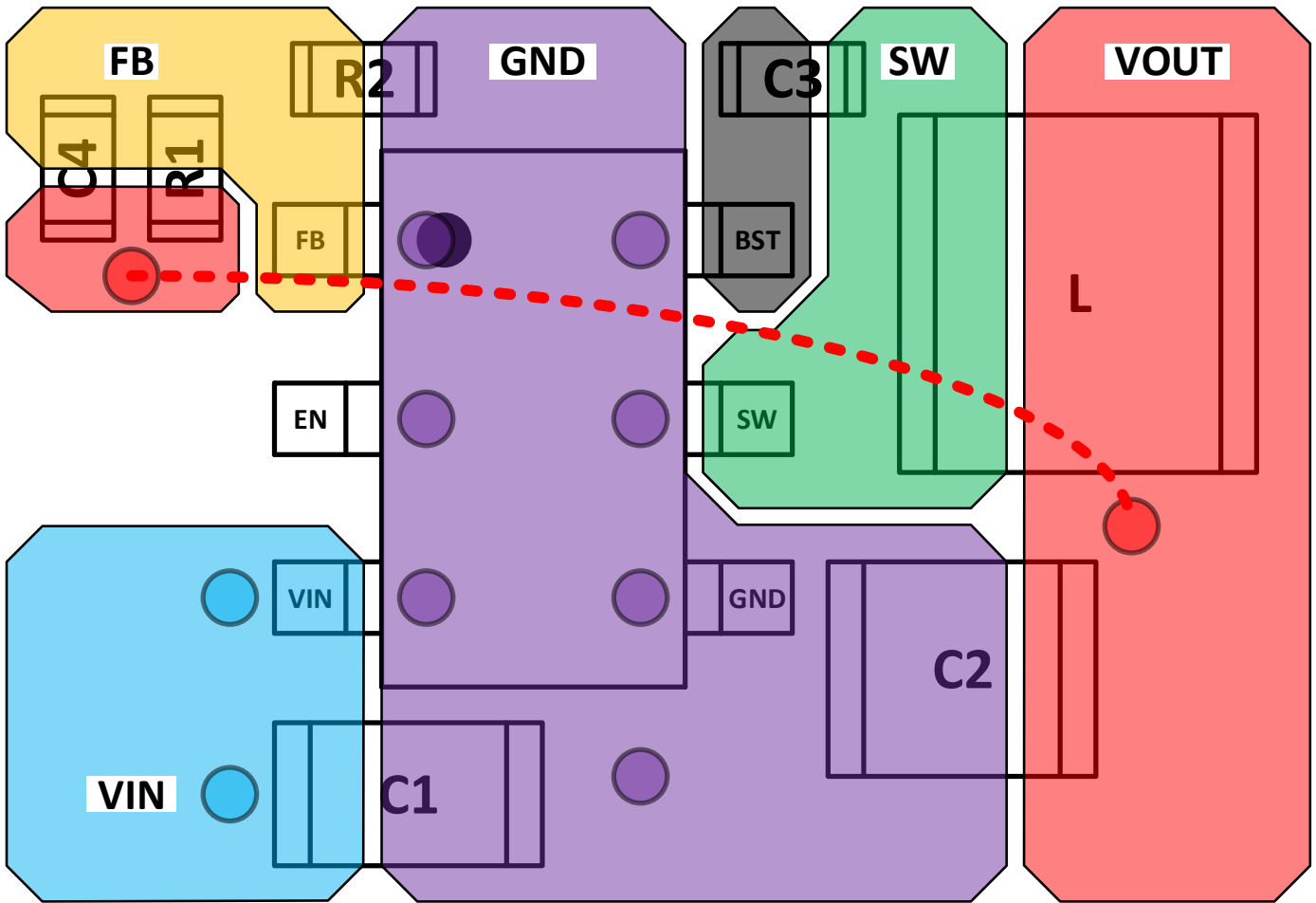
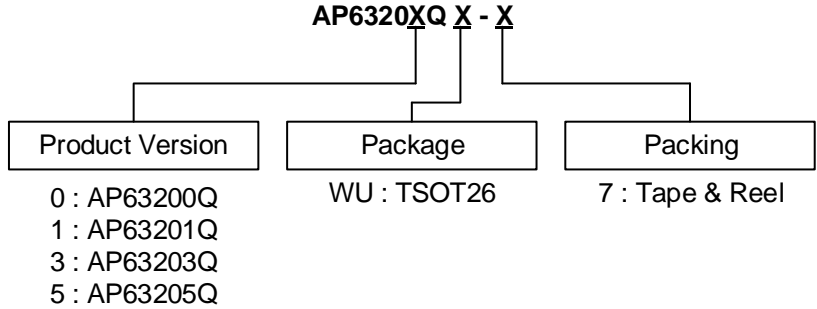

Figure 77. Recommended PCB Layout

### Ordering Information



Part Number	Output Voltage (V)	Switching Frequency (kHz)	Operation Mode	FSS Feature	Package Code	Tape and Reel	
						Quantity	Part Number Suffix
AP63200QWU-7	Adjustable	500	PFM/PWM	Yes	WU	3,000	-7
AP63201QWU-7	Adjustable	500	PWM Only	No	WU	3,000	-7
AP63203QWU-7	3.3	1100	PFM/PWM	Yes	WU	3,000	-7
AP63205QWU-7	5.0	1100	PFM/PWM	Yes	WU	3,000	-7

### Marking Information

TSOT26

**( Top View )**

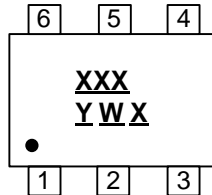

**XXX** : Identification Code  
**Y** : Year 0~9  
**W** : Week : A~Z : 1~26 week;  
a~z : 27~52 week; z represents 52 and 53 week  
**X** : Internal Code

Part Number	Package	Identification Code
AP63200QWU-7	TSOT26	T2Q
AP63201QWU-7	TSOT26	T3Q
AP63203QWU-7	TSOT26	T4Q
AP63205QWU-7	TSOT26	T5Q

**Package Outline Dimensions**

Please see <http://www.diodes.com/package-outlines.html> for the latest version.

TSOT26

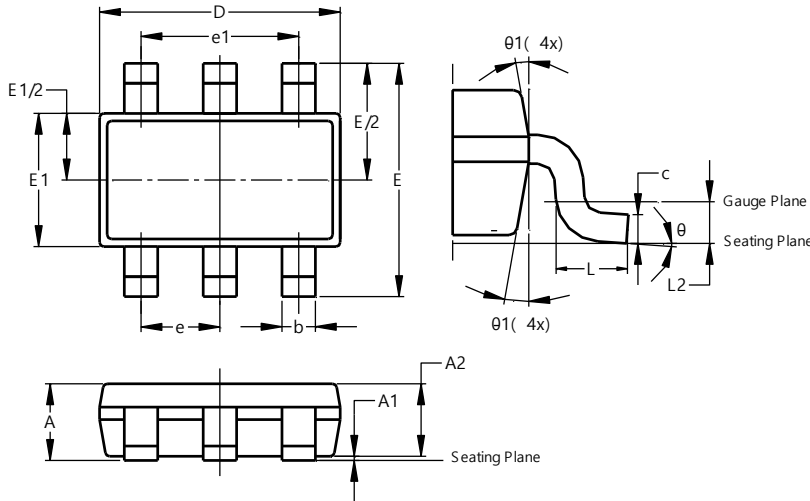

TSOT26			
Dim	Min	Max	Typ
A	—	1.00	—
A1	0.010	0.100	—
A2	0.840	0.900	—
D	2.800	3.000	2.900
E	2.800 BSC		
E1	1.500	1.700	1.600
b	0.300	0.450	—
c	0.120	0.200	—
e	0.950 BSC		
e1	1.900 BSC		
L	0.30	0.50	—
L2	0.250 BSC		
θ	0°	8°	4°
θ1	4°	12°	—
All Dimensions in mm			

**Suggested Pad Layout**

Please see <http://www.diodes.com/package-outlines.html> for the latest version.

TSOT26

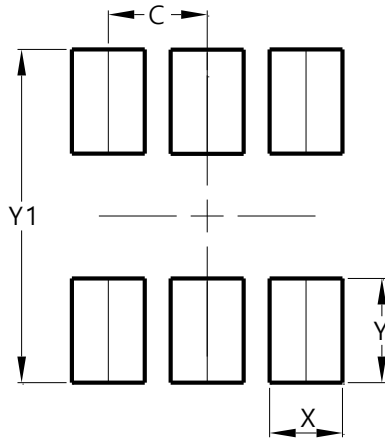

Dimensions	Value (in mm)
C	0.950
X	0.700
Y	1.000
Y1	3.200

**Mechanical Data**

- Moisture Sensitivity: Level 1 per J-STD-020
- Terminals: Finish – Matte Tin Plated Leads, Solderable per MIL-STD-202, Method 208 (e3)
- Weight: 0.013 grams (Approximate)

**IMPORTANT NOTICE**

1. DIODES INCORPORATED AND ITS SUBSIDIARIES (“DIODES”) MAKE NO WARRANTY OF ANY KIND, EXPRESS OR IMPLIED, WITH REGARDS TO ANY INFORMATION CONTAINED IN THIS DOCUMENT, INCLUDING, BUT NOT LIMITED TO, THE IMPLIED WARRANTIES OF MERCHANTABILITY, FITNESS FOR A PARTICULAR PURPOSE OR NON-INFRINGEMENT OF THIRD PARTY INTELLECTUAL PROPERTY RIGHTS (AND THEIR EQUIVALENTS UNDER THE LAWS OF ANY JURISDICTION).
2. The Information contained herein is for informational purpose only and is provided only to illustrate the operation of Diodes products described herein and application examples. Diodes does not assume any liability arising out of the application or use of this document or any product described herein. This document is intended for skilled and technically trained engineering customers and users who design with Diodes products. Diodes products may be used to facilitate safety-related applications; however, in all instances customers and users are responsible for (a) selecting the appropriate Diodes products for their applications, (b) evaluating the suitability of the Diodes products for their intended applications, (c) ensuring their applications, which incorporate Diodes products, comply the applicable legal and regulatory requirements as well as safety and functional-safety related standards, and (d) ensuring they design with appropriate safeguards (including testing, validation, quality control techniques, redundancy, malfunction prevention, and appropriate treatment for aging degradation) to minimize the risks associated with their applications.
3. Diodes assumes no liability for any application-related information, support, assistance or feedback that may be provided by Diodes from time to time. Any customer or user of this document or products described herein will assume all risks and liabilities associated with such use, and will hold Diodes and all companies whose products are represented herein or on Diodes’ websites, harmless against all damages and liabilities.
4. Products described herein may be covered by one or more United States, international or foreign patents and pending patent applications. Product names and markings noted herein may also be covered by one or more United States, international or foreign trademarks and trademark applications. Diodes does not convey any license under any of its intellectual property rights or the rights of any third parties (including third parties whose products and services may be described in this document or on Diodes’ website) under this document.
5. Diodes products are provided subject to Diodes’ Standard Terms and Conditions of Sale (<https://www.diodes.com/about/company/terms-and-conditions/terms-and-conditions-of-sales/>) or other applicable terms. This document does not alter or expand the applicable warranties provided by Diodes. Diodes does not warrant or accept any liability whatsoever in respect of any products purchased through unauthorized sales channel.
6. Diodes products and technology may not be used for or incorporated into any products or systems whose manufacture, use or sale is prohibited under any applicable laws and regulations. Should customers or users use Diodes products in contravention of any applicable laws or regulations, or for any unintended or unauthorized application, customers and users will (a) be solely responsible for any damages, losses or penalties arising in connection therewith or as a result thereof, and (b) indemnify and hold Diodes and its representatives and agents harmless against any and all claims, damages, expenses, and attorney fees arising out of, directly or indirectly, any claim relating to any noncompliance with the applicable laws and regulations, as well as any unintended or unauthorized application.
7. While efforts have been made to ensure the information contained in this document is accurate, complete and current, it may contain technical inaccuracies, omissions and typographical errors. Diodes does not warrant that information contained in this document is error-free and Diodes is under no obligation to update or otherwise correct this information. Notwithstanding the foregoing, Diodes reserves the right to make modifications, enhancements, improvements, corrections or other changes without further notice to this document and any product described herein. This document is written in English but may be translated into multiple languages for reference. Only the English version of this document is the final and determinative format released by Diodes.
8. Any unauthorized copying, modification, distribution, transmission, display or other use of this document (or any portion hereof) is prohibited. Diodes assumes no responsibility for any losses incurred by the customers or users or any third parties arising from any such unauthorized use.

Copyright © 2021 Diodes Incorporated

[www.diodes.com](http://www.diodes.com)

## Looking for pricing, stock, or lifecycle information?

Click below to explore more details on WIN SOURCE:

 [View AP63200QWU-7 on WIN SOURCE](#)

 [Diodes Incorporated](#) Information

## Optimize Your Supply Chain with WIN SOURCE Solutions

-  Global Sourcing Solution
-  Obsolete Management
-  Cost Control Management
-  Shortage Management
-  Alternative Solution
-  Excess Inventory Management