

OptiMOS® Power-Transistor
Feature

- N-Channel
- Enhancement mode
- Logic Level
- Green Product (RoHS Compliant)
- AEC Qualified

Product Summary

V_{DS}	55	V
$R_{DS(on)}$	33	m Ω
I_D	5.2	A

SOT 223

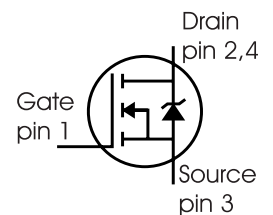
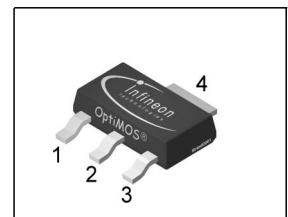

Type	Package	Ordering Code	Marking
BSP603S2L	SOT 223	On Request	2N603L

Maximum Ratings, at $T_j = 25\text{ }^\circ\text{C}$, unless otherwise specified

Parameter	Symbol	Value	Unit
Continuous drain current $T_A=25^\circ\text{C}$ $T_A=70^\circ\text{C}$	I_D	5.2 4.1	A
Pulsed drain current $T_A=25^\circ\text{C}$	$I_{D\text{ puls}}$	21	
Gate source voltage	V_{GS}	± 20	V
Power dissipation $T_A=25^\circ\text{C}$	P_{tot}	1.8	W
Operating and storage temperature IEC climatic category; DIN IEC 68-1	T_j, T_{stg}	-55... +150 55/150/00	$^\circ\text{C}$

Thermal Characteristics

Parameter	Symbol	Values			Unit
		min.	typ.	max.	
Characteristics					
Thermal resistance, junction - soldering point (Pin 4)	R_{thJS}	-	15	20	K/W
Thermal resistance, chip to ambient air:	R_{thJA}				
@ min. footprint @ 6 cm ² cooling area ¹⁾		-	-	120 70	

Electrical Characteristics, at $T_j = 25\text{ °C}$, unless otherwise specified

Parameter	Symbol	Values			Unit
		min.	typ.	max.	
Static Characteristics					
Drain-source breakdown voltage $V_{GS}=0V, I_D=1mA$	$V_{(BR)DSS}$	55	-	-	V
Gate threshold voltage, $V_{GS} = V_{DS}$ $I_D=50\mu A$	$V_{GS(th)}$	1.2	1.6	2	
Zero gate voltage drain current $V_{DS}=55V, V_{GS}=0V, T_j=25\text{ °C}$ $V_{DS}=55V, V_{GS}=0V, T_j=150\text{ °C}$	I_{DSS}	-	0.1 10	1 100	μA
Gate-source leakage current $V_{GS}=20V, V_{DS}=0V$	I_{GSS}	-	10	100	
Drain-source on-state resistance $V_{GS}=4.5V, I_D=2.6A$	$R_{DS(on)}$	-	27	40	m Ω
Drain-source on-state resistance $V_{GS}=10V, I_D=2.6A$	$R_{DS(on)}$	-	23	33	

¹⁾Device on 40mm*40mm*1.5mm epoxy PCB FR4 with 6cm² (one layer, 70 μm thick) copper area for drain connection. PCB is vertical without blown air.

Electrical Characteristics

Parameter	Symbol	Conditions	Values			Unit
			min.	typ.	max.	

Dynamic Characteristics

Transconductance	g_{fs}	$V_{DS} \geq 2 \cdot I_D \cdot R_{DS(on)max}$, $I_D = 5.2$	8.9	17.8	-	S
Input capacitance	C_{iss}	$V_{GS} = 0V$, $V_{DS} = 25V$, $f = 1MHz$	-	1034	1390	pF
Output capacitance	C_{oss}		-	244	325	
Reverse transfer capacitance	C_{rss}		-	75	110	
Turn-on delay time	$t_{d(on)}$	$V_{DD} = 30V$, $V_{GS} = 4.5V$, $I_D = 5.2A$, $R_G = 5.6\Omega$	-	10.8	16	ns
Rise time	t_r	$V_{DD} = 30V$, $V_{GS} = 4.5V$, $I_D = 5.2mA$, $R_G = 5.6\Omega$	-	16	24	
Turn-off delay time	$t_{d(off)}$		-	28	40	
Fall time	t_f		-	15	23	

Gate Charge Characteristics

Gate to source charge	Q_{gs}	$V_{DD} = 44V$, $I_D = 5.2A$	-	3.5	4.6	nC
Gate to drain charge	Q_{gd}		-	10.6	16	
Gate charge total	Q_g	$V_{DD} = 44V$, $I_D = 5.2A$, $V_{GS} = 0$ to $10V$	-	31	42	
Gate plateau voltage	$V_{(plateau)}$	$V_{DD} = 44V$, $I_D = 5.2A$	-	3	-	V

Reverse Diode

Inverse diode continuous forward current	I_S	$T_A = 25^\circ C$	-	-	5.2	A
Inv. diode direct current, pulsed	I_{SM}		-	-	21	
Inverse diode forward voltage	V_{SD}	$V_{GS} = 0V$, $I_F = 5.2A$	-	0.8	1.1	V
Reverse recovery time	t_{rr}	$V_R = 30V$, $I_F = I_S$, $di_F/dt = 100A/\mu s$	-	46	58	ns
Reverse recovery charge	Q_{rr}		-	44	55	nC

1 Power dissipation

$$P_{\text{tot}} = f(T_C)$$

parameter: $V_{GS} \geq 4 \text{ V}$

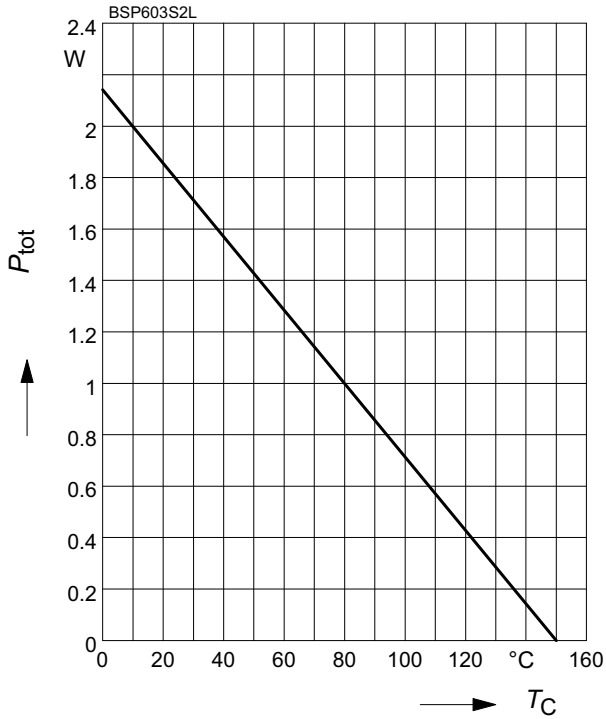

2 Drain current

$$I_D = f(T_C)$$

parameter: $V_{GS} \geq 10 \text{ V}$

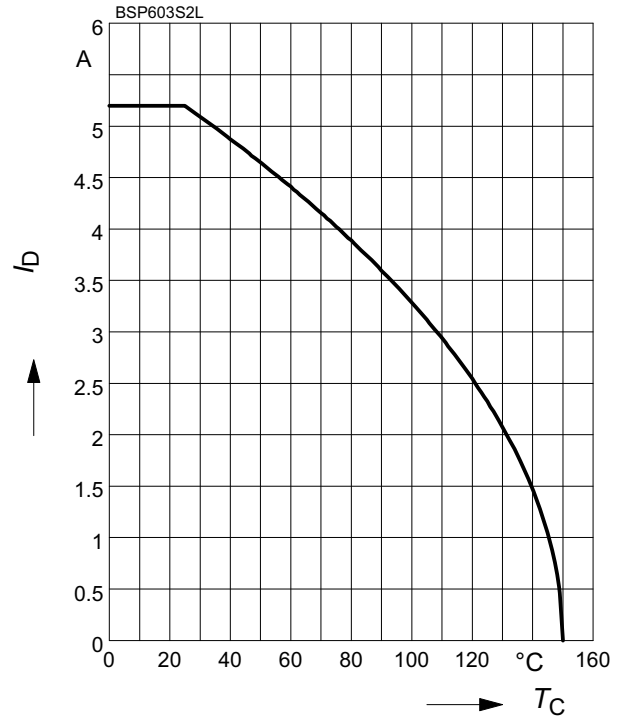

3 Safe operating area

$$I_D = f(V_{DS})$$

parameter: $D = 0, T_C = \text{--}$

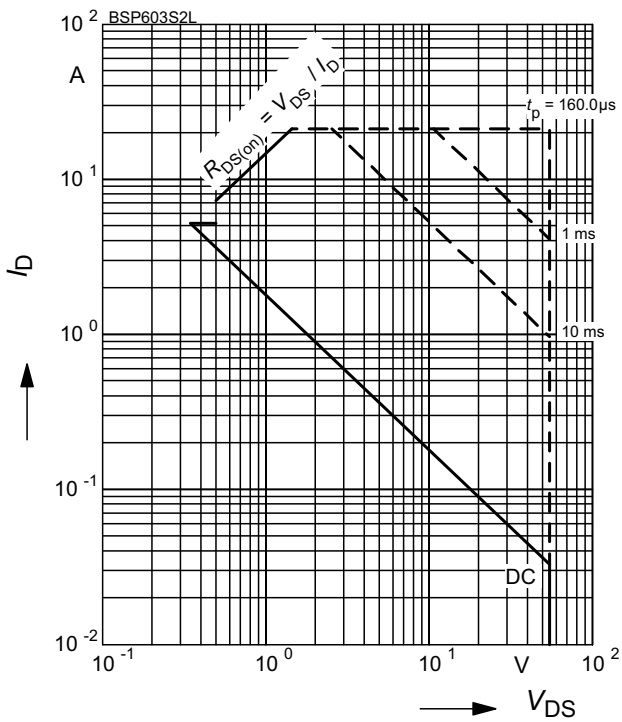

4 Max. transient thermal impedance

$$Z_{\text{thJC}} = f(t_p)$$

parameter: $D = t_p/T$

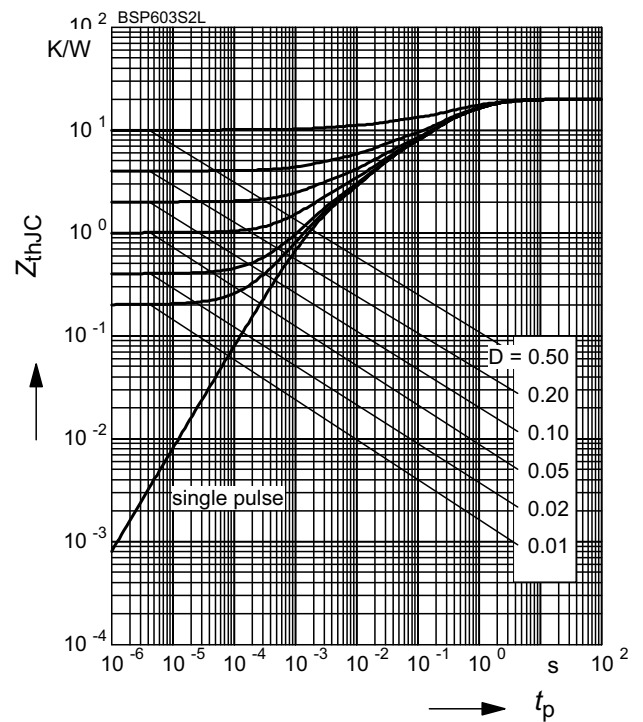

5 Typ. output characteristic

$I_D = f(V_{DS}); T_j = 25^\circ\text{C}$

parameter: $t_p = 80 \mu\text{s}$

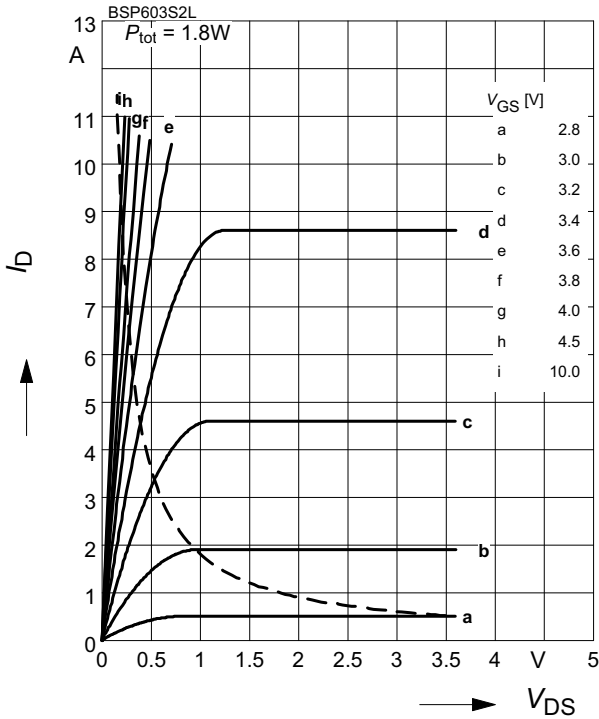

6 Typ. drain-source on resistance

$R_{DS(on)} = f(I_D)$

parameter: V_{GS}

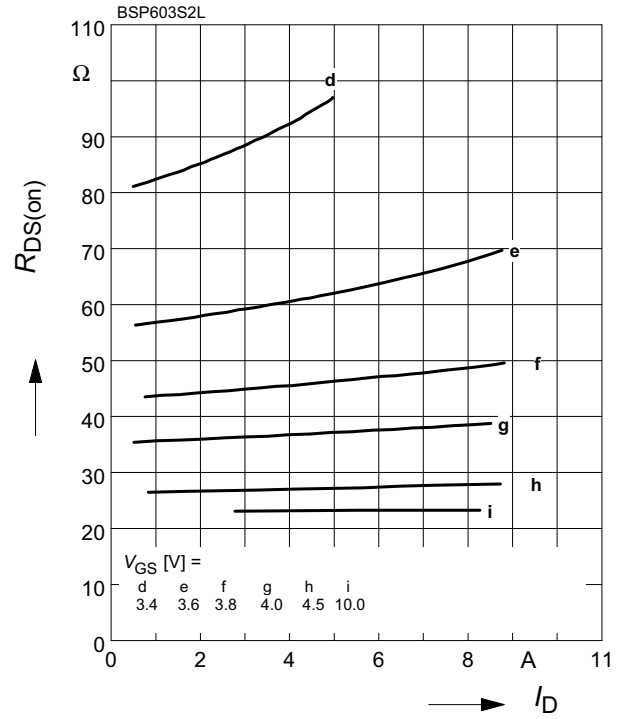

7 Typ. transfer characteristics

$I_D = f(V_{GS}); V_{DS} \geq 2 \times I_D \times R_{DS(on)max}$

parameter: $t_p = 80 \mu\text{s}$

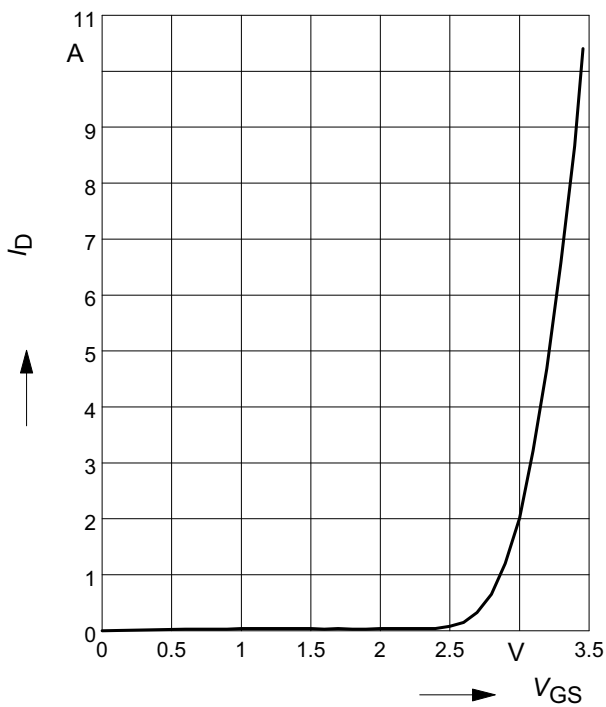

8 Typ. forward transconductance

$g_{fs} = f(I_D); T_j = 25^\circ\text{C}$

parameter: g_{fs}

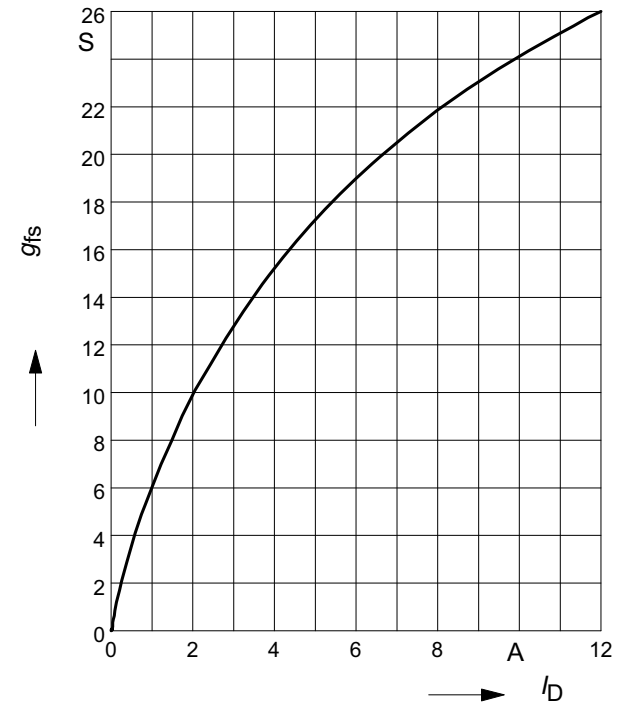

9 Drain-source on-state resistance

$$R_{DS(on)} = f(T_j)$$

parameter : $I_D = 2.6 \text{ A}$, $V_{GS} = 10 \text{ V}$

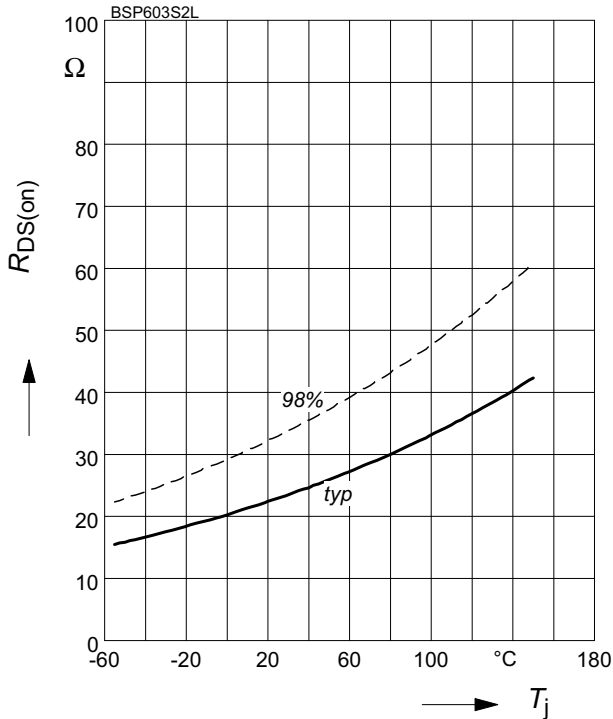

10 Typ. gate threshold voltage

$$V_{GS(th)} = f(T_j)$$

parameter: $V_{GS} = V_{DS}$

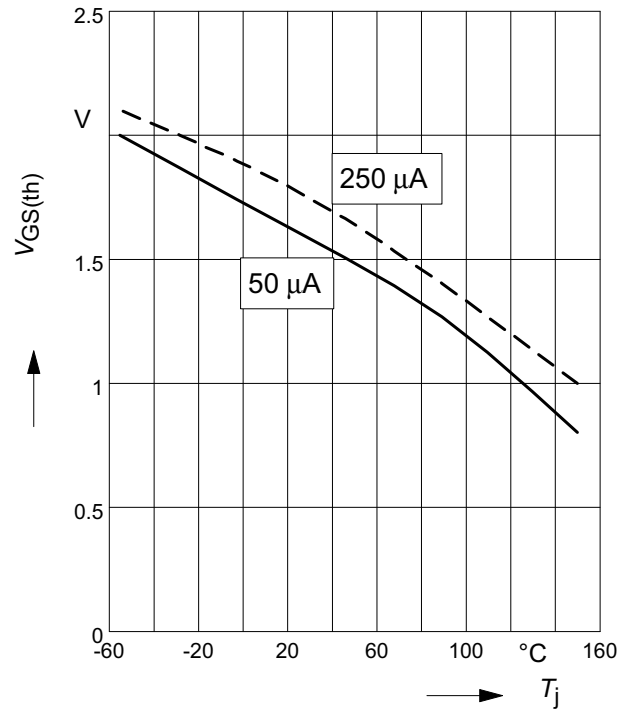

11 Typ. capacitances

$$C = f(V_{DS})$$

parameter: $V_{GS}=0\text{V}$, $f=1 \text{ MHz}$

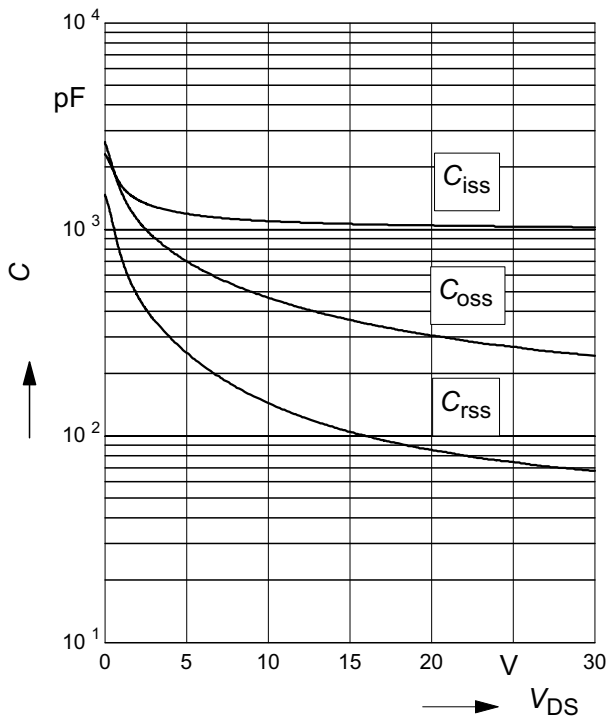

12 Forward character. of reverse diode

$$I_F = f(V_{SD})$$

parameter: T_j , $t_p = 80 \mu\text{s}$

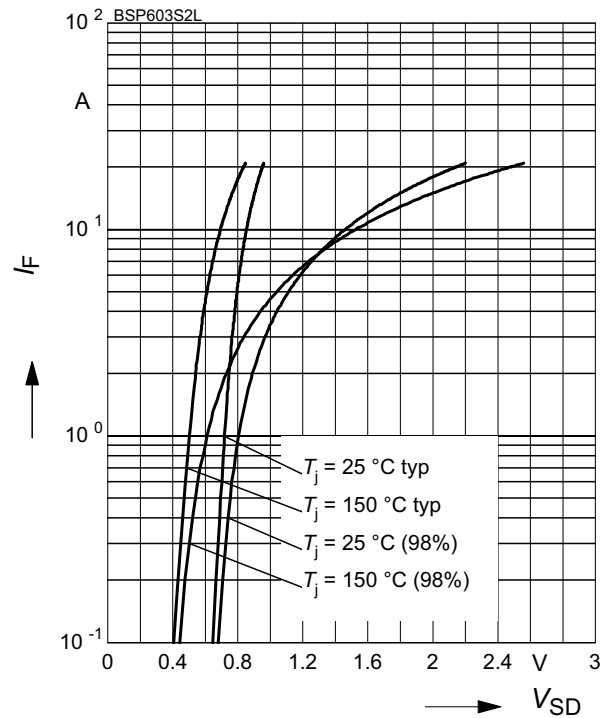

13 Typ. gate charge

$$V_{GS} = f(Q_{Gate})$$

parameter: $I_D = 5.2 \text{ A pulsed}$

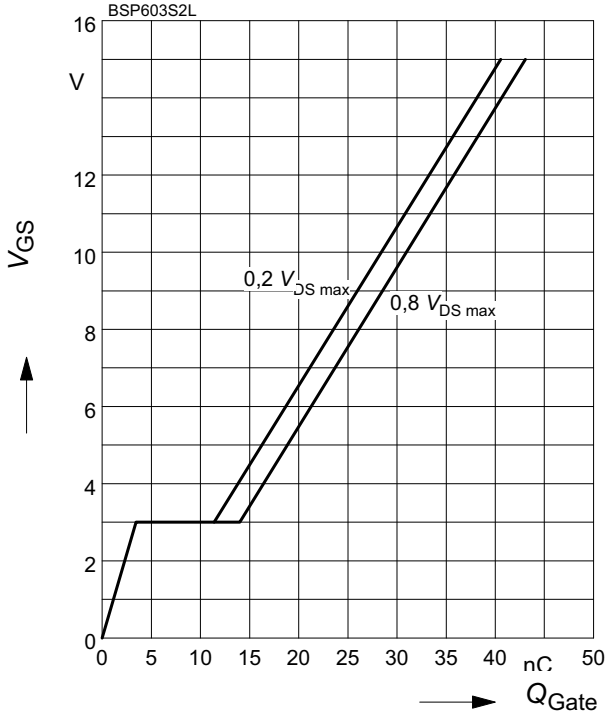

14 Drain-source breakdown voltage

$$V_{(BR)DSS} = f(T_j)$$

parameter: $I_D = 10 \text{ mA}$

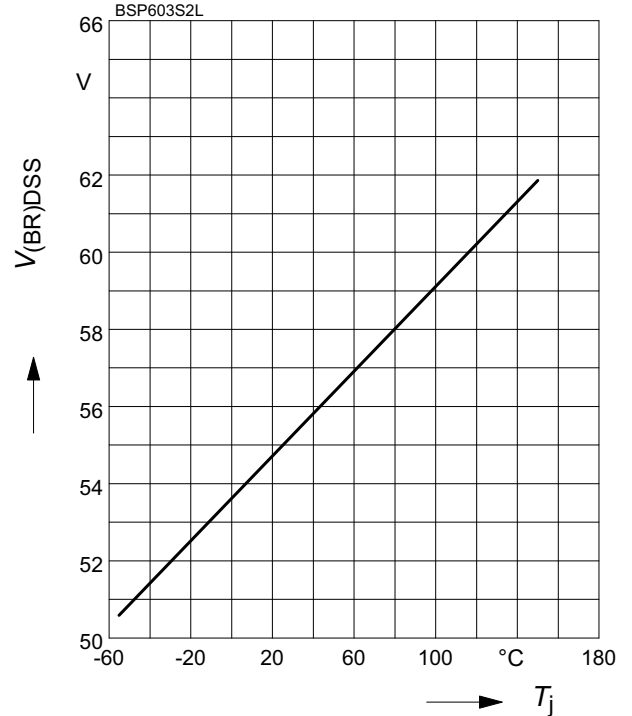

1 Package Outlines

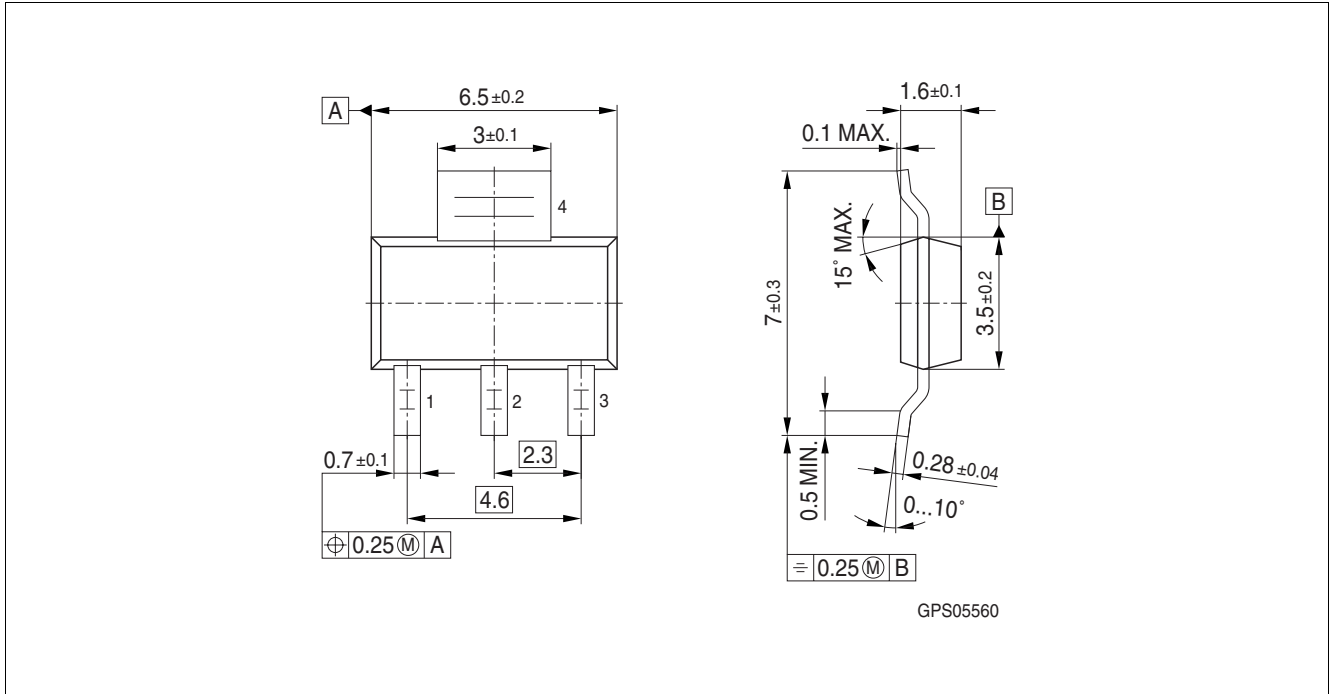

Figure 1 SOT 223

Green Product (RoHS compliant)

To meet the world-wide customer requirements for environmentally friendly products and to be compliant with government regulations the device is available as a green product. Green products are RoHS-Compliant (i.e. Pb-free finish on leads and suitable for Pb-free soldering according to IPC/JEDEC J-STD-020).

For further information on alternative packages, please visit our website:
<http://www.infineon.com/packages>.

Dimensions in mm

2 Revision History

Revision	Date	Changes
1.1	2008-05-27	Initial version of RoHS-compliant derivate of BSP603S2L Page 1: AEC certified statement added Page 1 and 8: added RoHS compliance statement and Green product feature Page 1 and 8: Package changed to RoHS compliant version Page 9-10: added Revision History, updated Legal Disclaimer

Edition 2008-05-27

**Published by
Infineon Technologies AG
81726 Munich, Germany**

**© 2008 Infineon Technologies AG
All Rights Reserved.**

Legal Disclaimer

The information given in this document shall in no event be regarded as a guarantee of conditions or characteristics. With respect to any examples or hints given herein, any typical values stated herein and/or any information regarding the application of the device, Infineon Technologies hereby disclaims any and all warranties and liabilities of any kind, including without limitation, warranties of non-infringement of intellectual property rights of any third party.

Information

For further information on technology, delivery terms and conditions and prices, please contact the nearest Infineon Technologies Office (www.infineon.com).



Warnings

Due to technical requirements, components may contain dangerous substances. For information on the types in question, please contact the nearest Infineon Technologies Office.

Infineon Technologies components may be used in life-support devices or systems only with the express written approval of Infineon Technologies, if a failure of such components can reasonably be expected to cause the failure of that life-support device or system or to affect the safety or effectiveness of that device or system. Life support devices or systems are intended to be implanted in the human body or to support and/or maintain and sustain and/or protect human life. If they fail, it is reasonable to assume that the health of the user or other persons may be endangered.

Looking for pricing, stock, or lifecycle information?

Click below to explore more details on WIN SOURCE:

-  [View BSP603S2L on WIN SOURCE](#)
-  [Infineon Technologies Information](#)

Optimize Your Supply Chain with WIN SOURCE Solutions

-  Global Sourcing Solution
-  Obsolete Management
-  Cost Control Management
-  Shortage Management
-  Alternative Solution
-  Excess Inventory Management