



**THE DATASHEET OF
BC857CWH6327XTSA1**



PNP Silicon AF Transistor

- For AF input stages and driver applications
- High current gain
- Low collector-emitter saturation voltage
- Low noise between 30 hz and 15 kHz
- Complementary types:
BC846...-BC850... (NPN)
- Pb-free (RoHS compliant) package¹⁾
- Qualified according AEC Q101

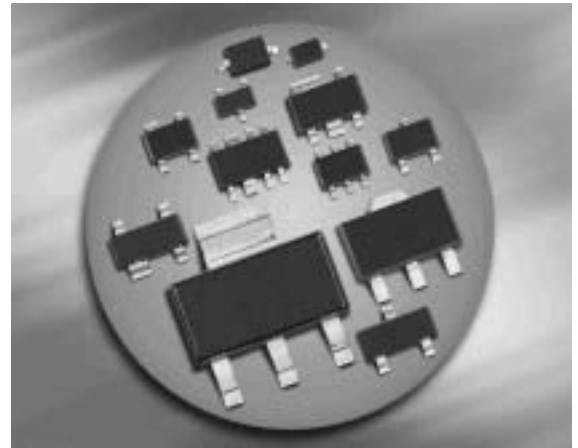

¹Pb-containing package may be available upon special request

Type	Marking	Pin Configuration						Package
		1=B	2=E	3=C	-	-	-	
BC856A	3As	1=B	2=E	3=C	-	-	-	SOT23
BC856B	3Bs	1=B	2=E	3=C	-	-	-	SOT23
BC856BW	3Bs	1=B	2=E	3=C	-	-	-	SOT323
BC857A	3Es	1=B	2=E	3=C	-	-	-	SOT23
BC857B	3Fs	1=B	2=E	3=C	-	-	-	SOT23
BC857BF	3Fs	1=B	2=E	3=C	-	-	-	TSFP-3
BC857BL3	3F	1=B	2=E	3=C	-	-	-	TSLP-3-1
BC857BW	3Fs	1=B	2=E	3=C	-	-	-	SOT323
BC857C	3Gs	1=B	2=E	3=C	-	-	-	SOT23
BC857CW	3Gs	1=B	2=E	3=C	-	-	-	SOT323
BC858A	3Js	1=B	2=E	3=C	-	-	-	SOT23
BC858B	3Ks	1=B	2=E	3=C	-	-	-	SOT23
BC858BL3	3K	1=B	2=E	3=C	-	-	-	TSLP-3-1
BC858BW	3Ks	1=B	2=E	3=C	-	-	-	SOT323
BC858C	3Ls	1=B	2=E	3=C	-	-	-	SOT23
BC858CW	3Ls	1=B	2=E	3=C	-	-	-	SOT323
BC859B	4Bs	1=B	2=E	3=C	-	-	-	SOT23
BC859C	4Cs	1=B	2=E	3=C	-	-	-	SOT23
BC860B	4Fs	1=B	2=E	3=C	-	-	-	SOT23
BC860BW	4Fs	1=B	2=E	3=C	-	-	-	SOT323
BC860CW	4Gs	1=B	2=E	3=C	-	-	-	SOT323

Maximum Ratings

Parameter	Symbol	Value	Unit
Collector-emitter voltage	V_{CEO}		V
BC856...		65	
BC857..., BC860...		45	
BC858..., BC859...		30	
Collector-base voltage	V_{CBO}		
BC856...		80	
BC857..., BC860...		50	
BC858..., BC859...		30	
Emitter-base voltage	V_{EBO}	5	
Collector current	I_C	100	mA
Peak collector current	I_{CM}	200	
Total power dissipation	P_{tot}		mW
$T_S \leq 71\text{ °C}$, BC856-BC860		330	
$T_S \leq 128\text{ °C}$, BC857BF-BC858BF		250	
$T_S \leq 135\text{ °C}$, BC857BL3, BC860BL3		250	
$T_S \leq 124\text{ °C}$, BC856W-BC860W		250	
Junction temperature	T_j	150	°C
Storage temperature	T_{stg}	-65 ... 150	

Thermal Resistance

Parameter	Symbol	Value	Unit
Junction - soldering point ¹⁾	R_{thJS}		K/W
BC856-BC860		≤ 240	
BC857BF-BC858BF		≤ 90	
BC857BL3, BC858BL3		≤ 60	
BC856W-BC860W		≤ 105	

¹⁾For calculation of R_{thJA} please refer to Application Note Thermal Resistance

Electrical Characteristics at $T_A = 25^\circ\text{C}$, unless otherwise specified

Parameter	Symbol	Values			Unit
		min.	typ.	max.	
DC Characteristics					
Collector-emitter breakdown voltage $I_C = 10\text{ mA}$, $I_B = 0$, BC856... $I_C = 10\text{ mA}$, $I_B = 0$, BC857..., BC860... $I_C = 10\text{ mA}$, $I_B = 0$, BC858..., BC859...	$V_{(BR)CEO}$	65 45 30	- - -	- - -	V
Collector-base breakdown voltage $I_C = 10\text{ }\mu\text{A}$, $I_E = 0$, BC856... $I_C = 10\text{ }\mu\text{A}$, $I_E = 0$, BC857..., BC860... $I_C = 10\text{ }\mu\text{A}$, $I_E = 0$, BC858..., BC859...	$V_{(BR)CBO}$	80 50 30	- - -	- - -	
Emitter-base breakdown voltage $I_E = 1\text{ }\mu\text{A}$, $I_C = 0$	$V_{(BR)EBO}$	5	-	-	
Collector-base cutoff current $V_{CB} = 45\text{ V}$, $I_E = 0$ $V_{CB} = 30\text{ V}$, $I_E = 0$, $T_A = 150\text{ }^\circ\text{C}$	I_{CBO}	- -	- -	0.015 5	μA
DC current gain ¹⁾ $I_C = 10\text{ }\mu\text{A}$, $V_{CE} = 5\text{ V}$, h_{FE} -grp.A $I_C = 10\text{ }\mu\text{A}$, $V_{CE} = 5\text{ V}$, h_{FE} -grp.B $I_C = 10\text{ }\mu\text{A}$, $V_{CE} = 5\text{ V}$, h_{FE} -grp.C $I_C = 2\text{ mA}$, $V_{CE} = 5\text{ V}$, h_{FE} -grp.A $I_C = 2\text{ mA}$, $V_{CE} = 5\text{ V}$, h_{FE} -grp.B $I_C = 2\text{ mA}$, $V_{CE} = 5\text{ V}$, h_{FE} -grp.C	h_{FE}	- - - 125 220 420	140 250 480 180 290 520	- - - 250 475 800	-
Collector-emitter saturation voltage ¹⁾ $I_C = 10\text{ mA}$, $I_B = 0.5\text{ mA}$ $I_C = 100\text{ mA}$, $I_B = 5\text{ mA}$	V_{CEsat}	- -	75 250	300 650	mV
Base emitter saturation voltage ¹⁾ $I_C = 10\text{ mA}$, $I_B = 0.5\text{ mA}$ $I_C = 100\text{ mA}$, $I_B = 0.5\text{ mA}$	V_{BEsat}	- -	700 850	- -	
Base-emitter voltage ¹⁾ $I_C = 2\text{ mA}$, $V_{CE} = 5\text{ V}$ $I_C = 10\text{ mA}$, $V_{CE} = 5\text{ V}$	$V_{BE(ON)}$	600 -	650 -	750 820	

¹⁾Pulse test: $t < 300\mu\text{s}$; $D < 2\%$

Electrical Characteristics at $T_A = 25^\circ\text{C}$, unless otherwise specified

Parameter	Symbol	Values			Unit
		min.	typ.	max.	
AC Characteristics					
Transition frequency $I_C = 20\text{ mA}$, $V_{CE} = 5\text{ V}$, $f = 100\text{ MHz}$	f_T	-	250	-	MHz
Collector-base capacitance $V_{CB} = 10\text{ V}$, $f = 1\text{ MHz}$	C_{cb}	-	1.5	-	pF
Emitter-base capacitance $V_{EB} = 0.5\text{ V}$, $f = 1\text{ MHz}$	C_{eb}	-	8	-	
Short-circuit input impedance $I_C = 2\text{ mA}$, $V_{CE} = 5\text{ V}$, $f = 1\text{ kHz}$, h_{FE} -grp.A $I_C = 2\text{ mA}$, $V_{CE} = 5\text{ V}$, $f = 1\text{ kHz}$, h_{FE} -grp.B $I_C = 2\text{ mA}$, $V_{CE} = 5\text{ V}$, $f = 1\text{ kHz}$, h_{FE} -grp.C	h_{11e}	-	2.7 4.5 8.7	-	k Ω
Open-circuit reverse voltage transf. ratio $I_C = 2\text{ mA}$, $V_{CE} = 5\text{ V}$, $f = 1\text{ kHz}$, h_{FE} -grp.A $I_C = 2\text{ mA}$, $V_{CE} = 5\text{ V}$, $f = 1\text{ kHz}$, h_{FE} -grp.B $I_C = 2\text{ mA}$, $V_{CE} = 5\text{ V}$, $f = 1\text{ kHz}$, h_{FE} -grp.C	h_{12e}	-	1.5 2 3	-	10^{-4}
Short-circuit forward current transf. ratio $I_C = 2\text{ mA}$, $V_{CE} = 5\text{ V}$, $f = 1\text{ kHz}$, h_{FE} -grp.A $I_C = 2\text{ mA}$, $V_{CE} = 5\text{ V}$, $f = 1\text{ kHz}$, h_{FE} -grp.B $I_C = 2\text{ mA}$, $V_{CE} = 5\text{ V}$, $f = 1\text{ kHz}$, h_{FE} -grp.C	h_{21e}	-	200 330 600	-	-
Open-circuit output admittance $I_C = 2\text{ mA}$, $V_{CE} = 5\text{ V}$, $f = 1\text{ kHz}$, h_{FE} -grp.A $I_C = 2\text{ mA}$, $V_{CE} = 5\text{ V}$, $f = 1\text{ kHz}$, h_{FE} -grp.B $I_C = 2\text{ mA}$, $V_{CE} = 5\text{ V}$, $f = 1\text{ kHz}$, h_{FE} -grp.C	h_{22e}	-	18 30 60	-	μS
Noise figure $I_C = 0.2\text{ mA}$, $V_{CE} = 5\text{ V}$, $f = 1\text{ kHz}$, D $f = 200\text{ Hz}$, $R_S = 2\text{ k}\Omega$, BC859, BC850	F	-	1	4	dB
Equivalent noise voltage $I_C = 200\text{ mA}$, $V_{CE} = 5\text{ V}$, $R_S = 2\text{ k}\Omega$, $f = 10\text{...}50\text{ Hz}$, BC860	V_n	-	-	0.11	μV

DC current gain $h_{FE} = f(I_C)$

$V_{CE} = 1\text{ V}$

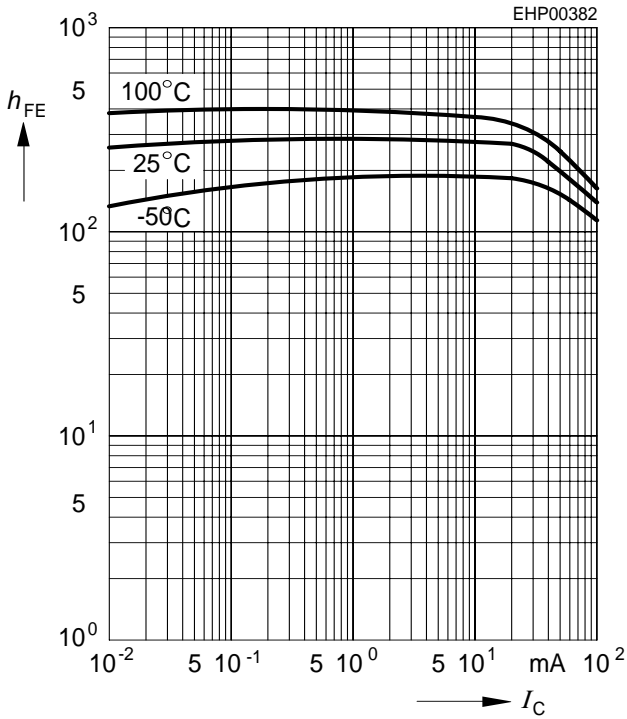

Collector-emitter saturation voltage

$I_C = f(V_{CEsat}), h_{FE} = 20$

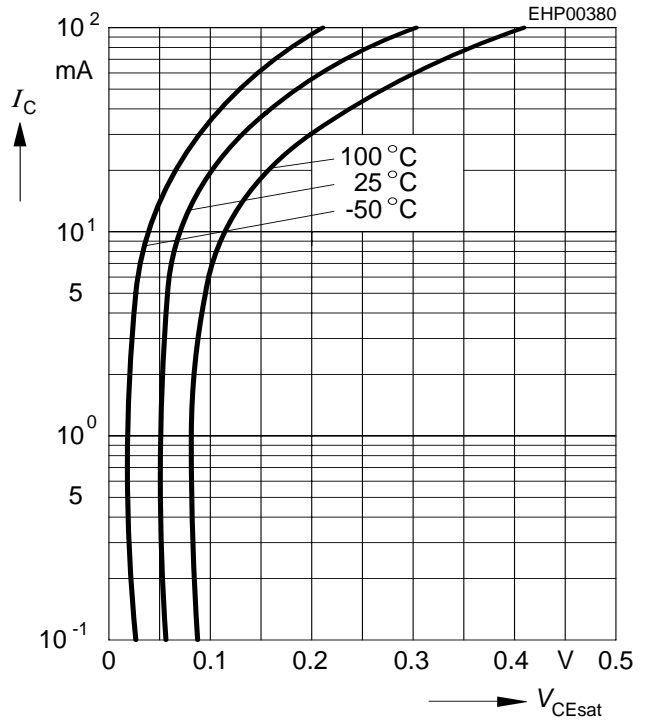

Base-emitter saturation voltage

$I_C = f(V_{BEsat}), h_{FE} = 20$

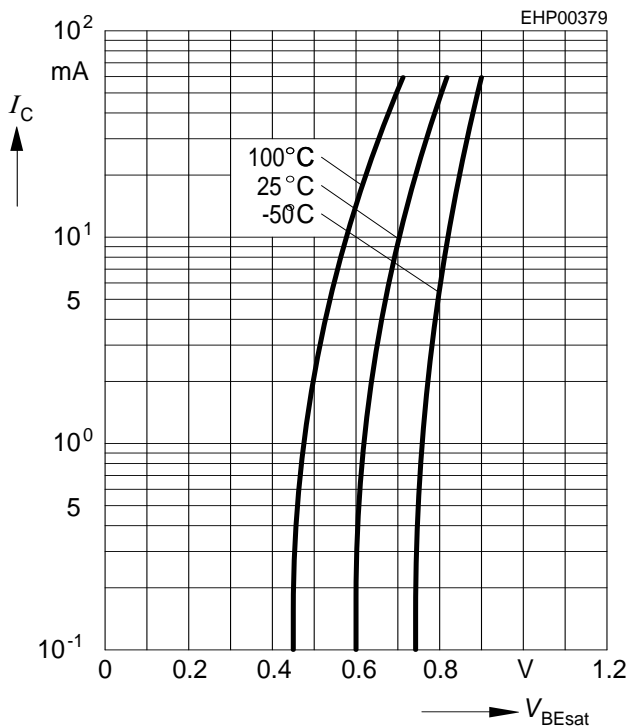

Collector cutoff current $I_{CBO} = f(T_A)$

$V_{CBO} = 30\text{ V}$

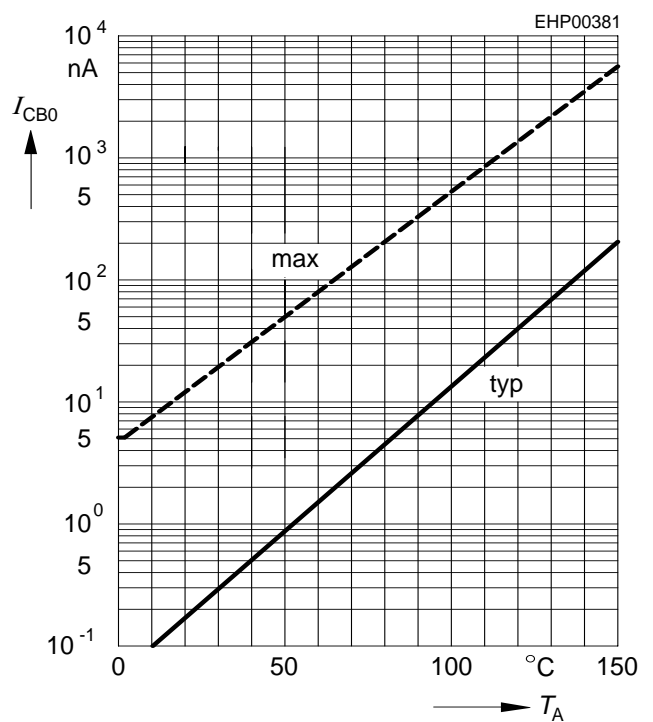

Transition frequency $f_T = f(I_C)$

$V_{CE} = 5\text{ V}$

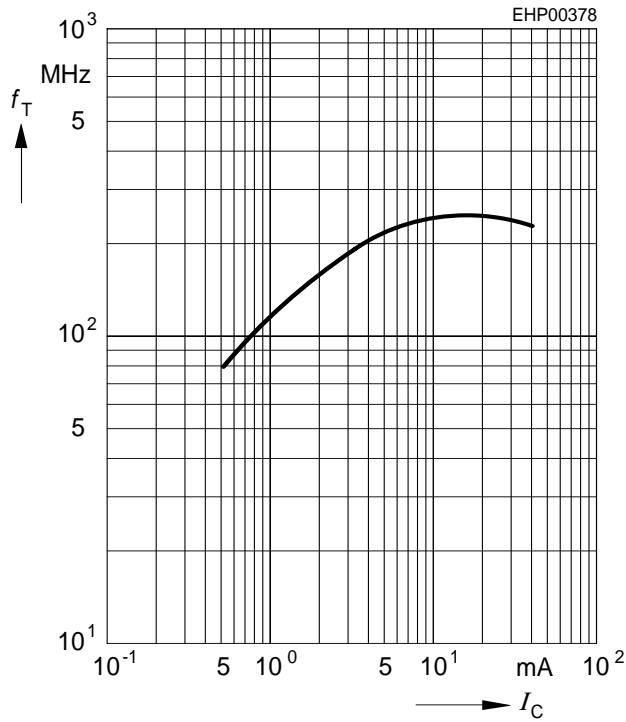

Collector-base capacitance $C_{cb} = f(V_{CB})$

Emitter-base capacitance $C_{eb} = f(V_{EB})$

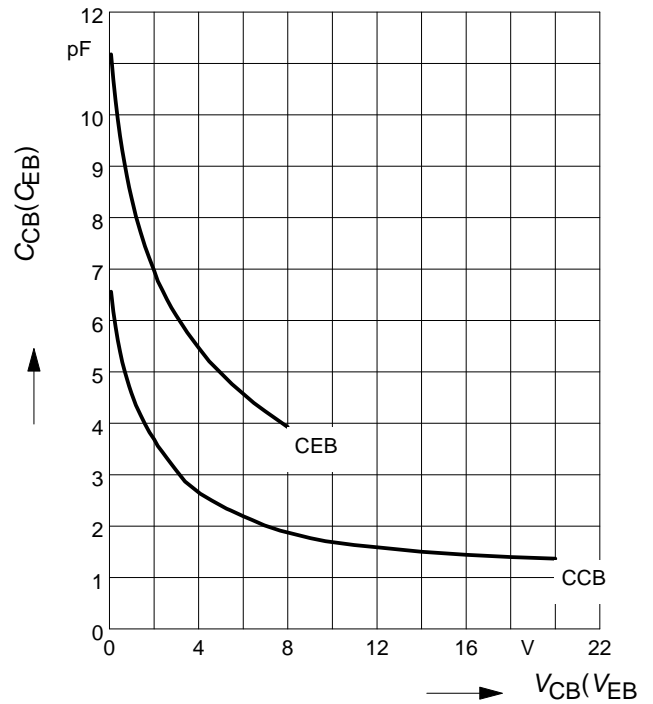

Total power dissipation $P_{tot} = f(T_S)$

BC856-BC860

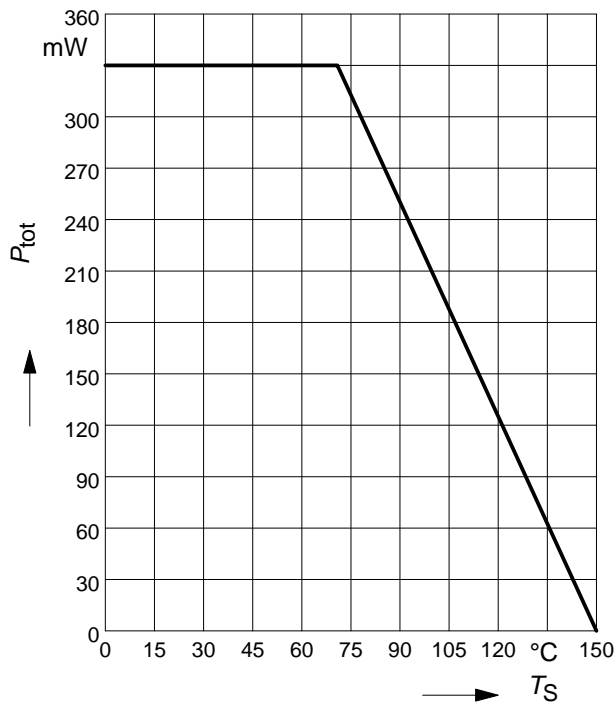

Total power dissipation $P_{tot} = f(T_S)$

BC857BF, BC858BF

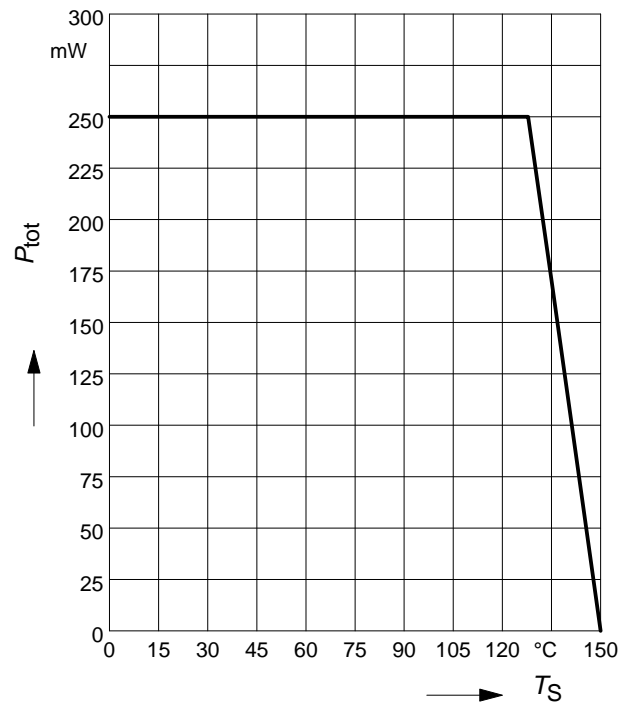

Total power dissipation $P_{tot} = f(T_S)$

BC857BL3, BC858BL3

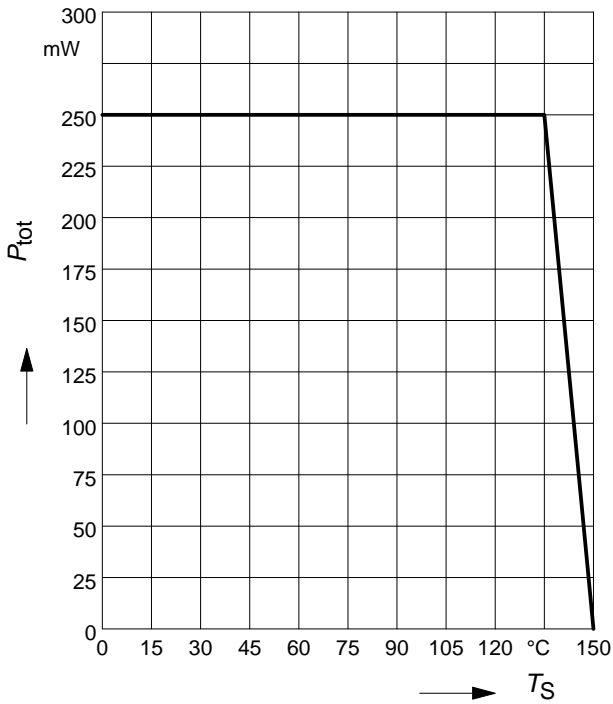

Total power dissipation $P_{tot} = f(T_S)$

BC856W-BC860W

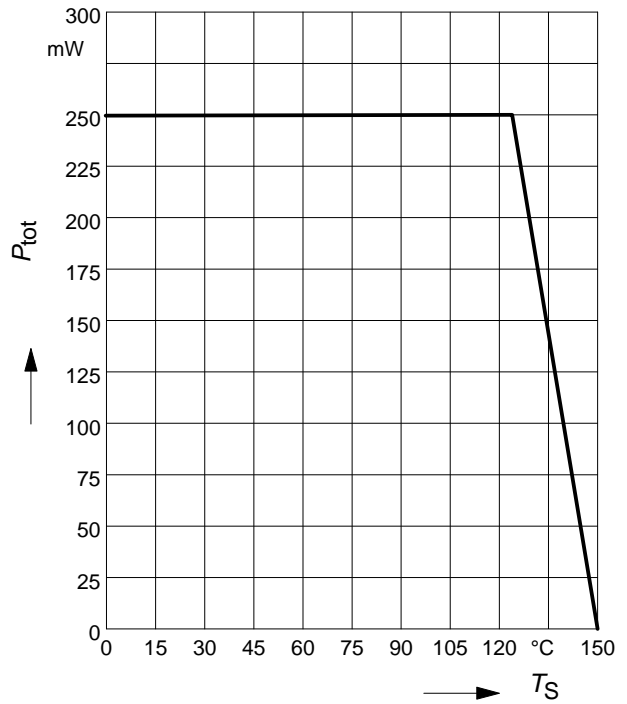

Permissible Pulse Load

$P_{totmax}/P_{totDC} = f(t_p)$

BC856/W-BC860/W

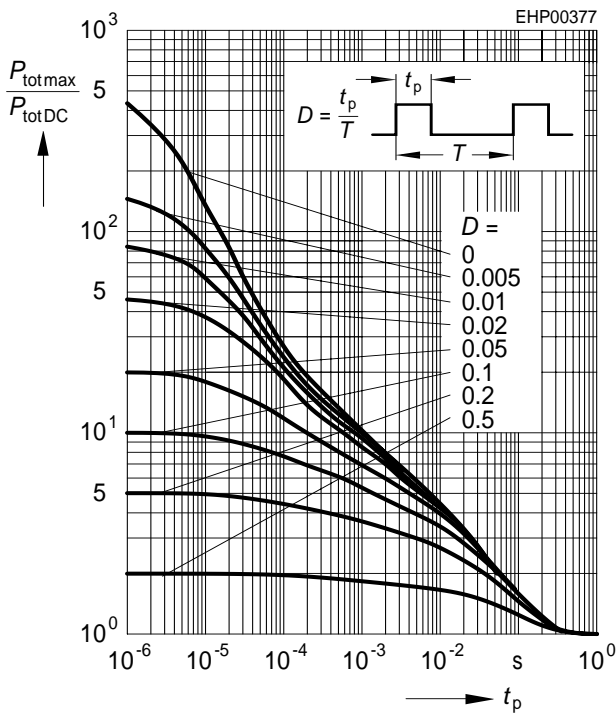

Permissible Puls Load $R_{thJS} = f(t_p)$

BC857BF, BC858BF

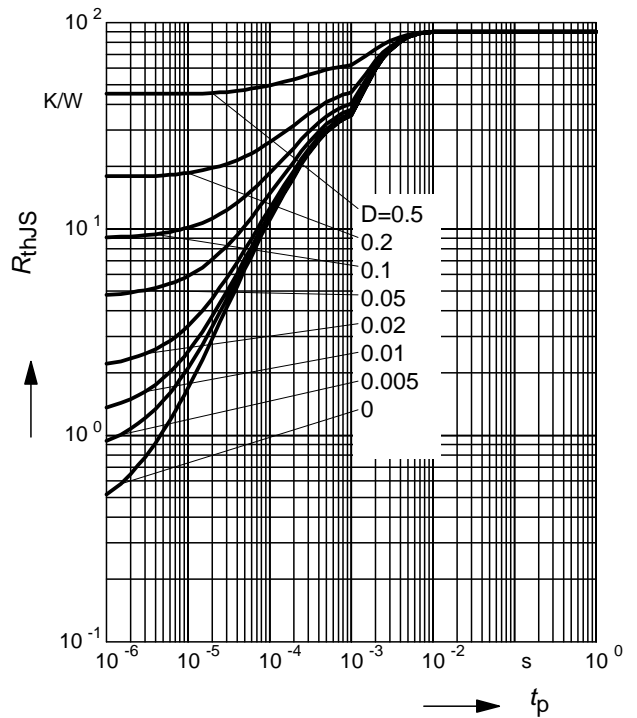

Permissible Pulse Load

$$P_{\text{totmax}}/P_{\text{totDC}} = f(t_p)$$

BC857BF, BC858BF

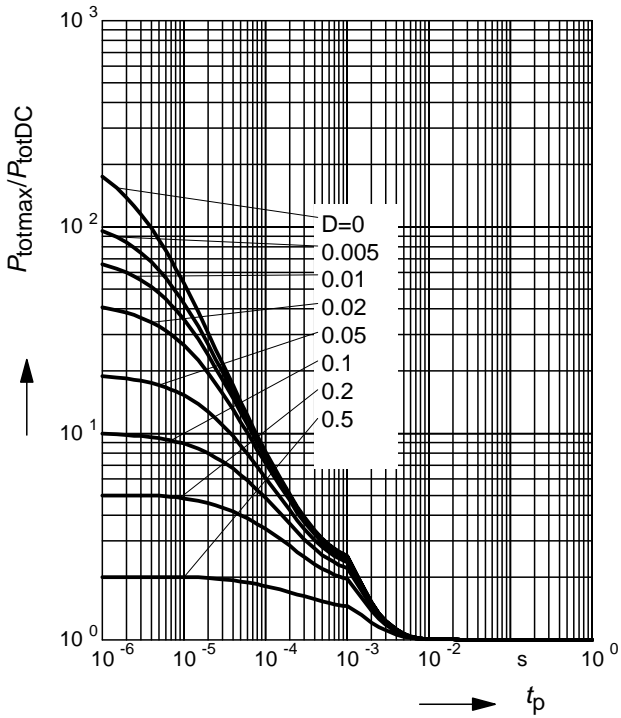

Permissible Puls Load $R_{\text{thJS}} = f(t_p)$

BC857BL3, BC858BL3

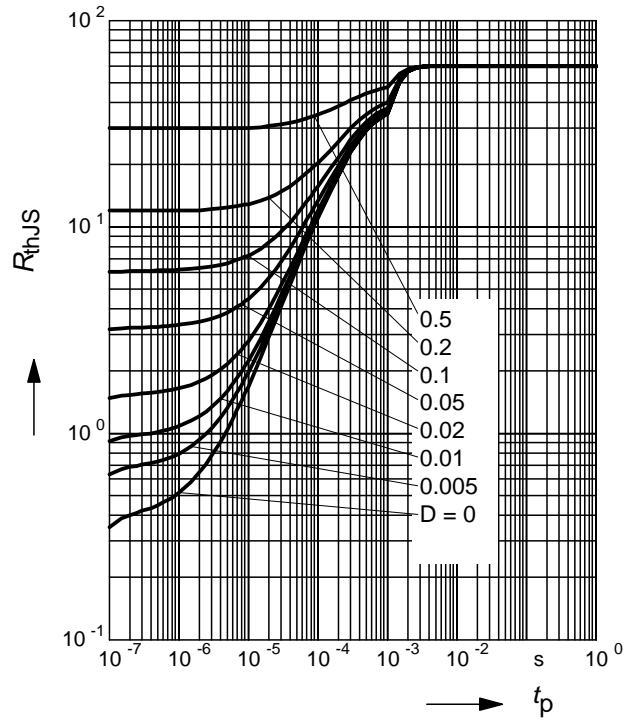

Permissible Pulse Load

$$P_{\text{totmax}}/P_{\text{totDC}} = f(t_p)$$

BC857BL3, BC858BL3

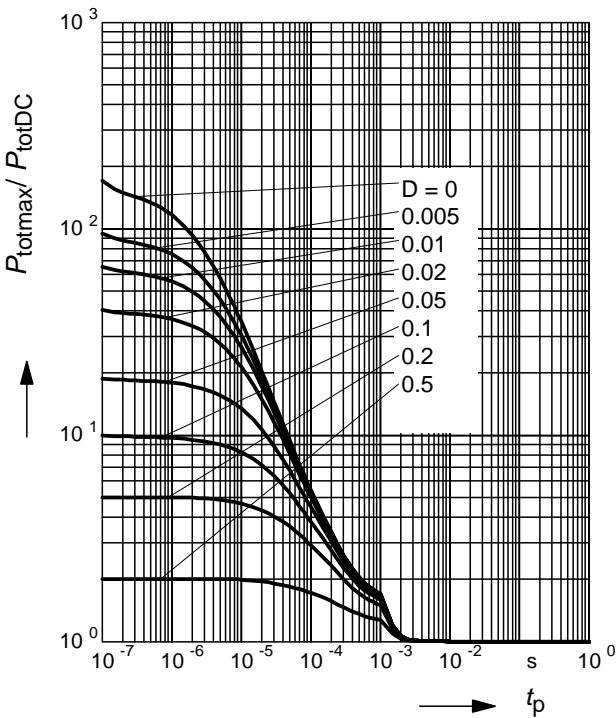

Package Outline

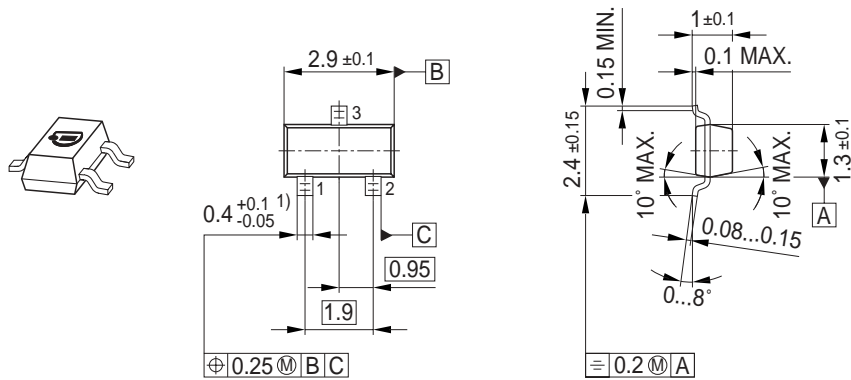

1) Lead width can be 0.6 max. in dambar area

Foot Print

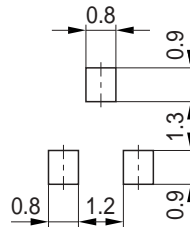

Marking Layout (Example)

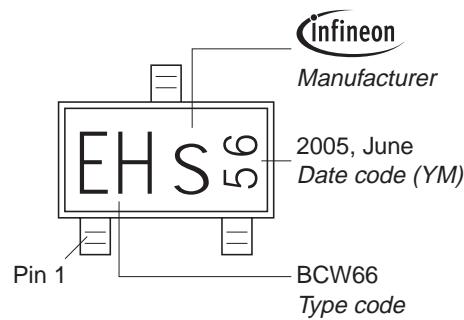

Standard Packing

Reel \varnothing 180 mm = 3.000 Pieces/Reel
 Reel \varnothing 330 mm = 10.000 Pieces/Reel

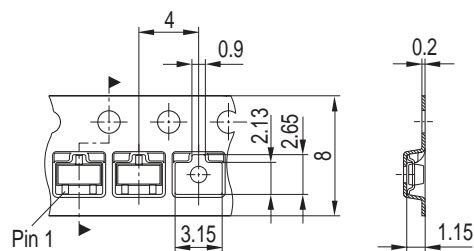

Package Outline

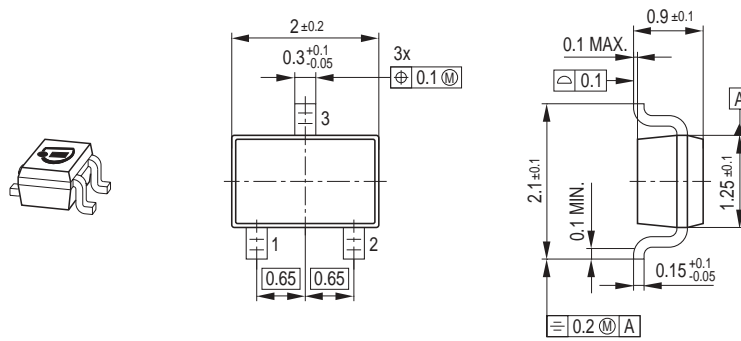

Foot Print

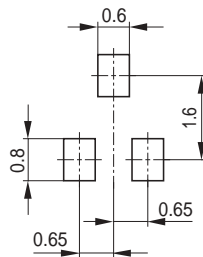

Marking Layout (Example)

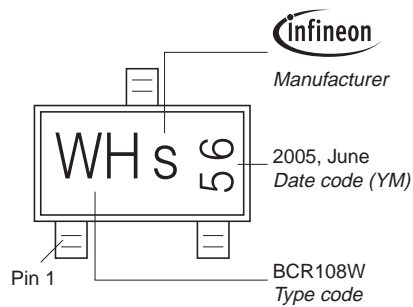

Standard Packing

Reel ø180 mm = 3.000 Pieces/Reel
 Reel ø330 mm = 10.000 Pieces/Reel

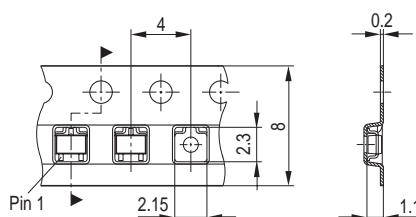

Package Outline

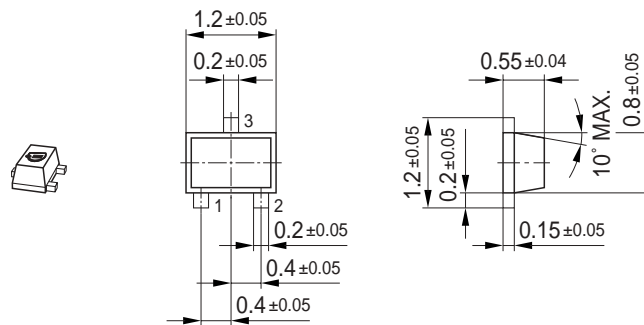

Foot Print

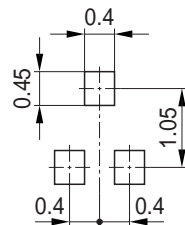

Marking Layout (Example)

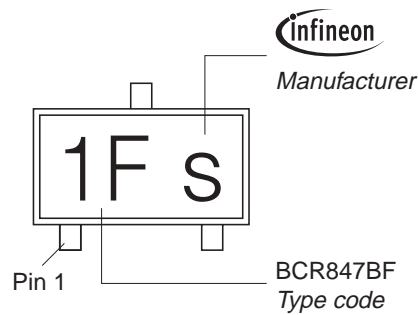

Standard Packing

Reel ø180 mm = 3.000 Pieces/Reel
 Reel ø330 mm = 10.000 Pieces/Reel

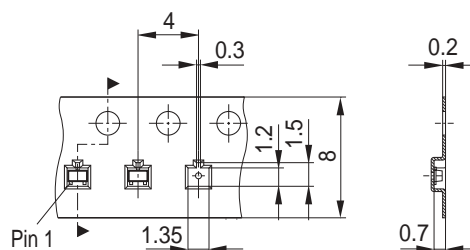

Package Outline

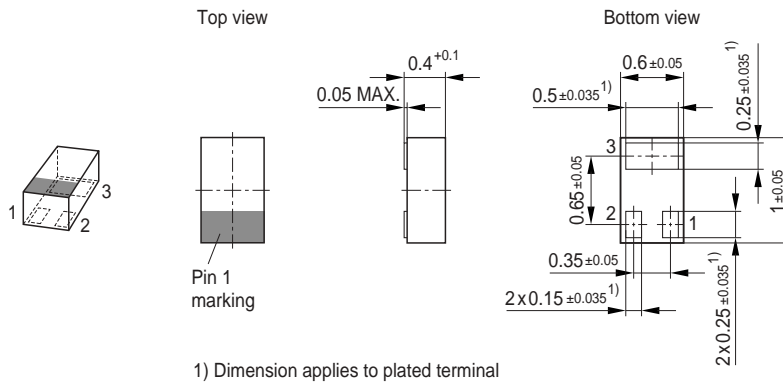

Foot Print

For board assembly information please refer to Infineon website "Packages"

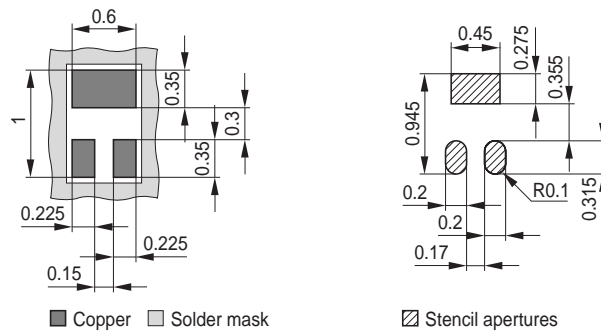

Marking Layout (Example)

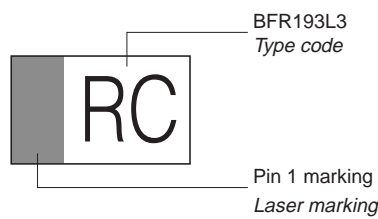

Standard Packing

Reel ø180 mm = 15.000 Pieces/Reel

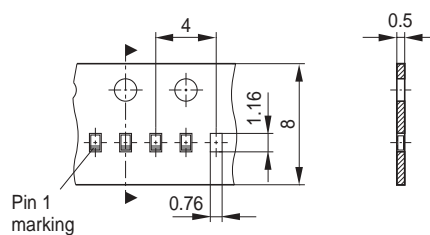

Edition 2006-02-01

Published by

Infineon Technologies AG

81726 München, Germany

© Infineon Technologies AG 2007.

All Rights Reserved.

Attention please!

The information given in this dokument shall in no event be regarded as a guarantee of conditions or characteristics ("Beschaffenheitsgarantie"). With respect to any examples or hints given herein, any typical values stated herein and/or any information regarding the application of the device, Infineon Technologies hereby disclaims any and all warranties and liabilities of any kind, including without limitation warranties of non-infringement of intellectual property rights of any third party.

Information

For further information on technology, delivery terms and conditions and prices please contact your nearest Infineon Technologies Office (www.infineon.com).

Warnings



Due to technical requirements components may contain dangerous substances. For information on the types in question please contact your nearest Infineon Technologies Office.

Infineon Technologies Components may only be used in life-support devices or systems with the express written approval of Infineon Technologies, if a failure of such components can reasonably be expected to cause the failure of that life-support device or system, or to affect the safety or effectiveness of that device or system.

Life support devices or systems are intended to be implanted in the human body, or to support and/or maintain and sustain and/or protect human life. If they fail, it is reasonable to assume that the health of the user or other persons may be endangered.

Looking for pricing, stock, or lifecycle information?

Click below to explore more details on WIN SOURCE:

-  [View BC857CWH6327XTSA1 on WIN SOURCE](#)
-  [Infineon Technologies Information](#)

Optimize Your Supply Chain with WIN SOURCE Solutions

-  Global Sourcing Solution
-  Obsolete Management
-  Cost Control Management
-  Shortage Management
-  Alternative Solution
-  Excess Inventory Management