



**THE DATASHEET OF
BD12IC0WHFV-GTR**



1A Variable / Fixed Output LDO Regulators



BDxxIC0WEFJ / BDxxIC0WHFV

● General Description

BDxxIC0W series devices are LDO regulators with an output current of 1.0A. The output accuracy is $\pm 1\%$ of the output voltage. Both fixed and variable output voltage devices are available. The output voltage of the variable output voltage device can be varied from 0.8 to 4.5V using external resistors. Various fixed output voltage devices that do not use external resistors are also available. These LDO regulators are available in two package types: HTSOP-J8 (4.90mm x 6.00mm x 1.00mm) and HVSO6 (1.60mm x 3.00mm x 0.75mm), and can be used in a wide variety of digital appliances. These devices have built in over current protection to protect the device when output is shorted, $0\mu\text{A}$ shutdown mode and thermal shutdown circuit to protect the device during over load conditions. These LDO regulators are usable with ceramic capacitors that enable a smaller layout and longer life.

● Features

- +/-1% output voltage accuracy
- Built-in Over Current Protection circuit (OCP)
- Built-in Thermal Shut Down circuit (TSD)
- Zero μA Shutdown mode

● Key Specifications

- Input Power Supply Voltage range: 2.4V to 5.5V
- Output Voltage range(Variable type): 0.8V to 4.5V
- Output Voltage(Fixed type): 1.0V/1.2V/1.25V/1.5V
1.8V/2.5V/2.6V/3.0V/3.3V
(1.25V/2.6V:HVSO6 only)
- Output Current: 1.0A (Max.)
- Shutdown Current: 0 μA (Typ.)
- Operating Temperature Range: -25 to +85°C

● Package

	(Typ.)	(Typ.)	(Max.)
HTSOP-J8	4.90mm	6.00mm	1.00mm
HVSO6	1.60mm	3.00mm	0.75mm

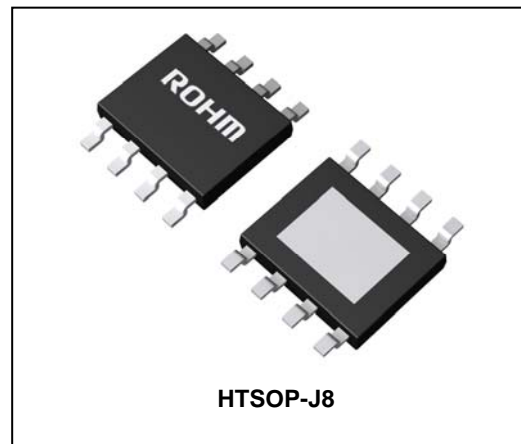

● Typical Application Circuit

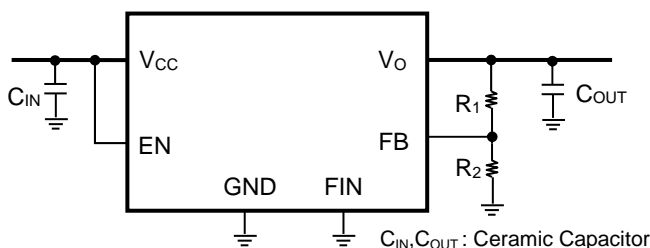

Output voltage variable type

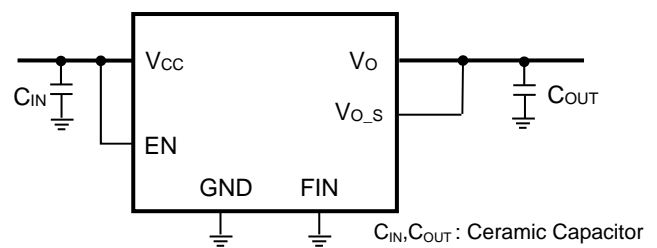

Output voltage fixed type

○Product structure : Silicon monolithic integrated circuit ○This product is not designed with protection against radioactive rays.

●Ordering Information

B D x x I C 0 W y y y						-	z z
Part Number	Output voltage	Input voltage range	Output current	Shutdown mode	Package	Packaging and forming specification	
	00:Variable 10:1.0V 12:1.2V 1C:1.25V 15:1.5V 18:1.8V 25:2.5V 26:2.6V 30:3.0V 33:3.3V	:7V	C0:1.0A	"W": included	EFJ : HTSOP-J8 HFV : HVSO6	E2 : Emboss tape reel(HTSOP-J8) GTR : Emboss tape reel(HVSO6)	

●Block Diagram

BD00IC0WEFJ / BD00IC0WHFV (Variable output voltage type)

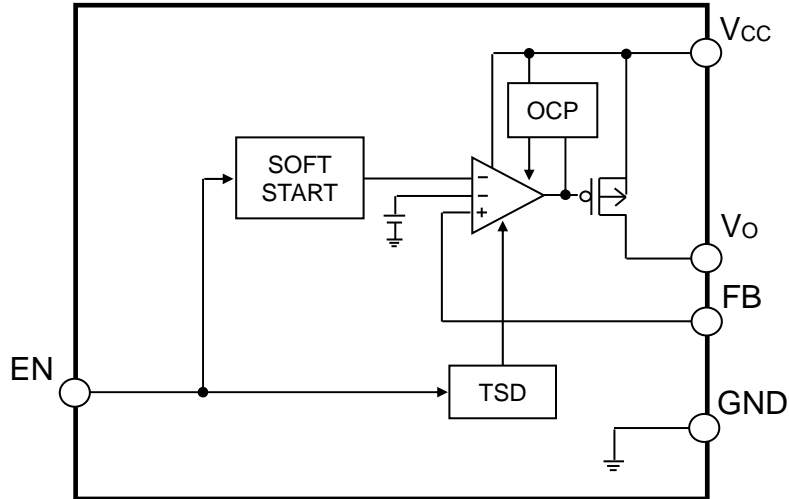
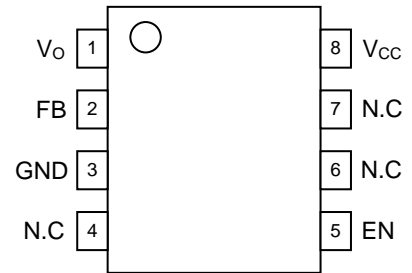

Fig.1 Block Diagram

●Pin Configuration and Pin Description

(HTSOP-J8)

Pin No.	Pin name	Pin Function
1	Vo	Output pin
2	FB	Feedback pin
3	GND	GND pin
4	N.C	No Connect (Connect to GND or leave OPEN)
5	EN	Enable pin
6	N.C	No Connect (Connect to GND or leave OPEN)
7	N.C	No Connect (Connect to GND or leave OPEN)
8	Vcc	Input pin
Reverse	FIN	Substrate (Connect to GND)



(HVSOF6)

Pin No.	Pin name	Pin Function
1	Vo	Output pin
2	FB	Feedback pin
3	GND	GND pin
4	EN	Enable pin
5	N.C	No Connect (Connect to GND or leave OPEN)
6	Vcc	Input pin
Reverse	FIN	Substrate (Connect to GND)

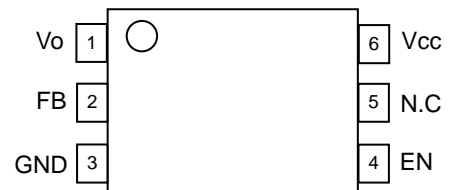

●Block Diagram

BDxxIC0WEFJ / BDxxIC0WHFV (Fixed output voltage type)

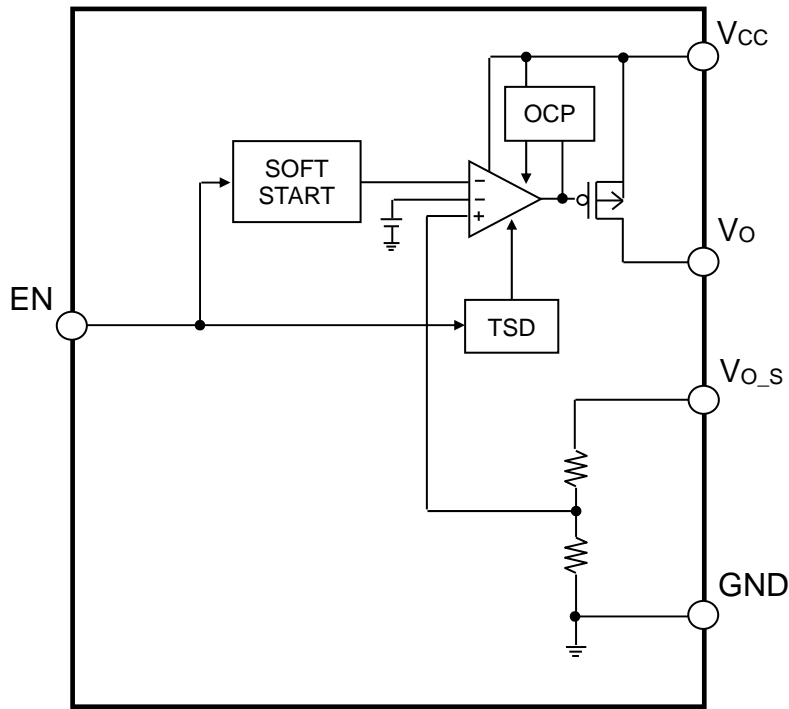
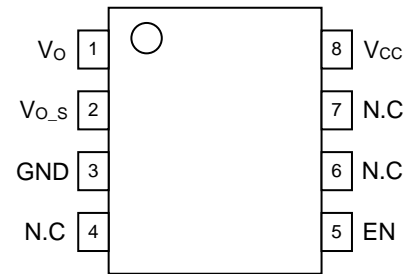

Fig.2 Block Diagram

●Pin Configuration and Pin Description

(HTSOP-J8)

Pin No.	Pin name	Pin Function
1	Vo	Output pin
2	Vo_s	Output voltage monitor pin
3	GND	GND pin
4	N.C	No Connect (Connect to GND or leave OPEN)
5	EN	Enable pin
6	N.C	No Connect (Connect to GND or leave OPEN)
7	N.C	No Connect (Connect to GND or leave OPEN)
8	Vcc	Input pin
Reverse	FIN	Substrate (Connect to GND)



(HVSOF6)

Pin No.	Pin name	Pin Function
1	Vo	Output pin
2	Vo_s	Output voltage monitor pin
3	GND	GND pin
4	EN	Enable pin
5	N.C	No Connect (Connect to GND or leave OPEN)
6	Vcc	Input pin
Reverse	FIN	Substrate (Connect to GND)

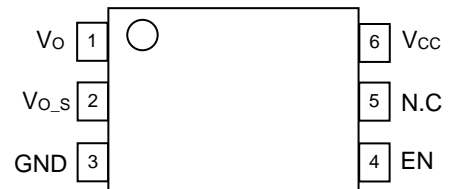

● Absolute Maximum Ratings (Ta=25°C)

Parameter	Symbol	Ratings	Unit	
Power supply voltage	V _{CC}	-0.3 to 7.0 *1	V	
EN voltage	V _{EN}	-0.3 to 7.0	V	
Power dissipation	HTSOP-J8	P _d	2.11 *2	W
	HVSOF6	P _d	1.70 *3	W
Operating Temperature Range	T _{opr}	-25 to +85	°C	
Storage Temperature Range	T _{stg}	-55 to +150	°C	
Junction Temperature	T _{jmax}	+150	°C	

*1 Not to exceed P_d

*2 Reduced by 16.9mW/°C for each increase in Ta of 1°C over 25°C. (when mounted on a board 70mm × 70mm × 1.6mm glass-epoxy board, two layer)

*3 Reduced by 13.6mW/°C for each increase in Ta of 1°C over 25°C. (when mounted on a board 70mm × 70mm × 1.6mm glass-epoxy board, single-layer(copper foil are :51%))

● Recommended Operating Ratings (Ta=25°C)

Parameter	Symbol	Ratings		Unit
		Min.	Max.	
Input power supply voltage	V _{CC}	2.4	5.5	V
EN voltage	V _{EN}	0.0	5.5	V
Output voltage setting range	V _O	0.8	4.5	V
Output current	I _O	0.0	1.0	A

● Electrical Characteristics (Unless otherwise noted, Ta=25°C, EN=3V, V_{CC}=3.3V, R1=16kΩ, R2=7.5kΩ)

Parameter	Symbol	Limits			Unit	Conditions
		Min.	Typ.	Max.		
Circuit current at shutdown mode	I _{STB}	-	0	5	μA	V _{EN} =0V, OFF mode
Bias current	I _{CC}	-	250	500	μA	
Line regulation	Reg.li	-1	-	1	%	V _{CC} =(V _O +0.6V)→5.5V
Load regulation	Reg I _O	-1.5	-	1.5	%	I _O =0→1.0A
Minimum dropout voltage1	V _{CO1}	-	0.10	0.15	V	V _{CC} =3.3V, I _O =250mA
Minimum dropout voltage2	V _{CO2}	-	0.20	0.30	V	V _{CC} =3.3V, I _O =500mA
Minimum dropout voltage3	V _{CO3}	-	0.30	0.45	V	V _{CC} =3.3V, I _O =750mA
Minimum dropout voltage4	V _{CO4}	-	0.40	0.60	V	V _{CC} =3.3V, I _O =1.0A
Output reference voltage(variable type)	V _{FB}	0.792	0.800	0.808	V	I _O =0A
Output voltage(Fixed type)	V _O	V _O × 0.99	V _O	V _O × 1.01	V	I _O =0A
EN Low voltage	V _{EN_Low}	0	-	0.8	V	
EN High voltage	V _{EN_High}	2.4	-	5.5	V	
EN Bias current	I _{EN}	1	3	9	μA	

● Typical Performance Curves

(Unless otherwise noted, Ta=25°C, EN=3V, Vcc=3.3V, R1=16kΩ, R2=7.5kΩ)

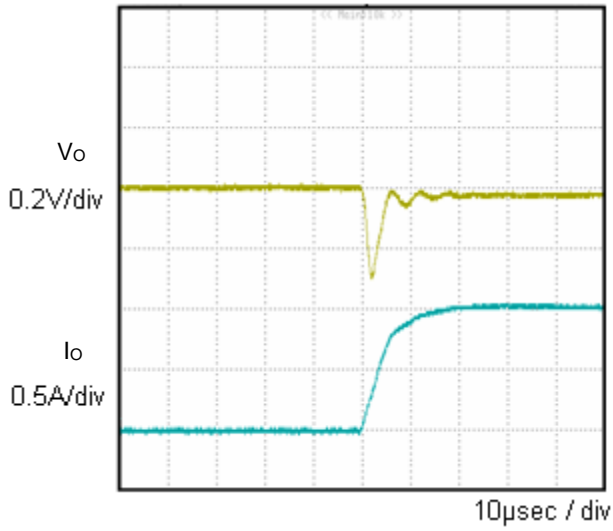

Fig.3
Transient Response(0→1.0A)
Co=1.0µF

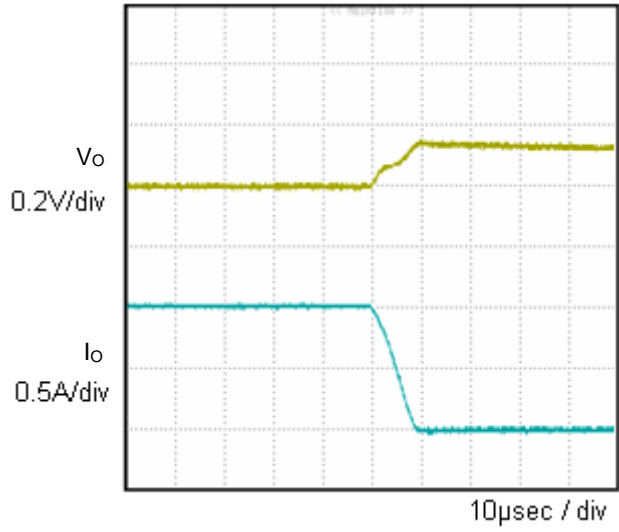

Fig.4
Transient Response(1.0→0A)
Co=1.0µF

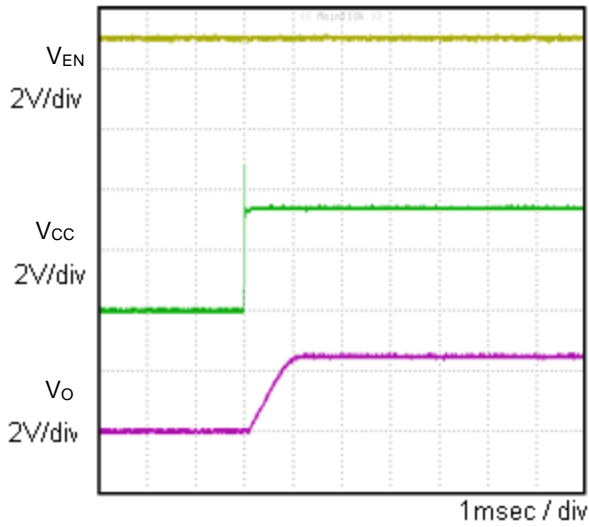

Fig.5
Input sequence1
Co=1.0µF

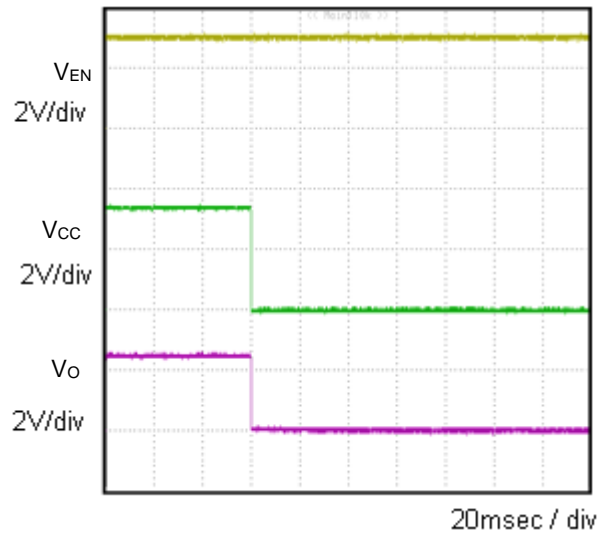

Fig.6
OFF sequence 1
Co=1.0µF

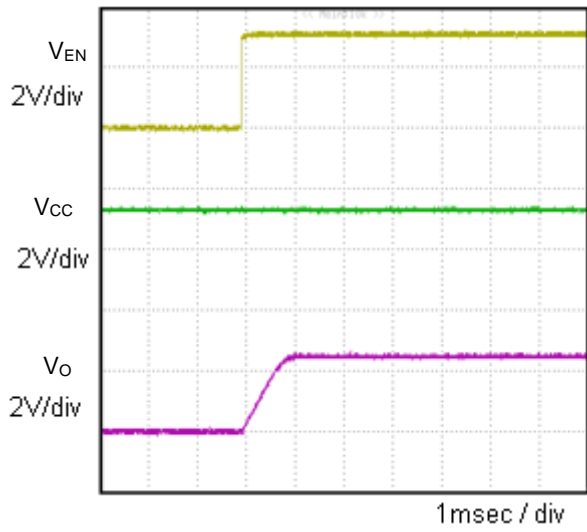

Fig.7
Input sequence2
 $C_o=1.0\mu F$

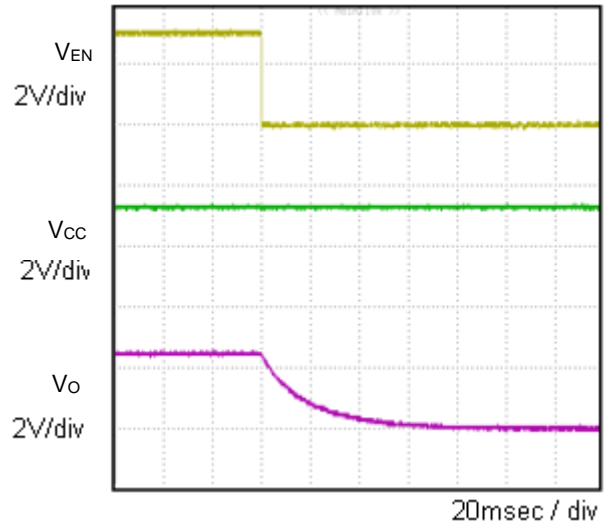

Fig.8
OFF sequence 2
 $C_o=1.0\mu F$

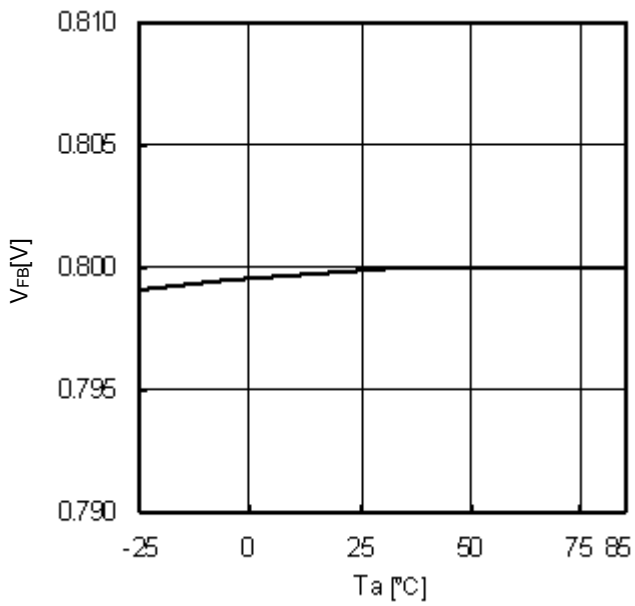

Fig.9
 T_a-V_{FB}

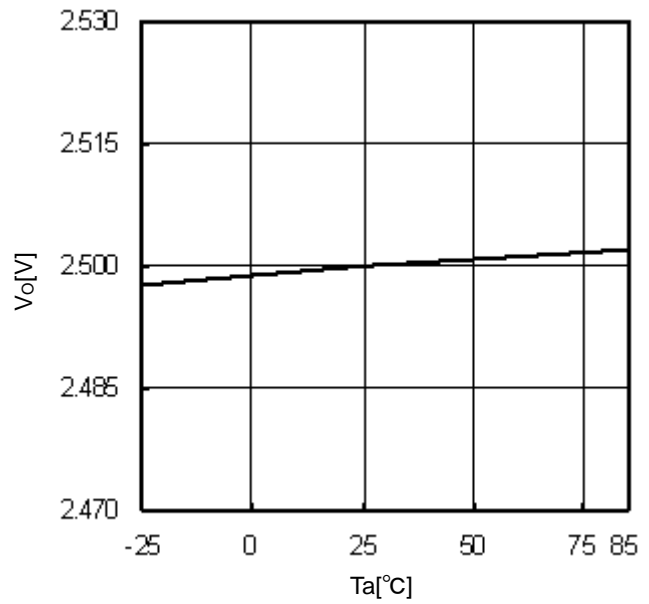

Fig.10
 $T_a-V_o (I_o=0A)$

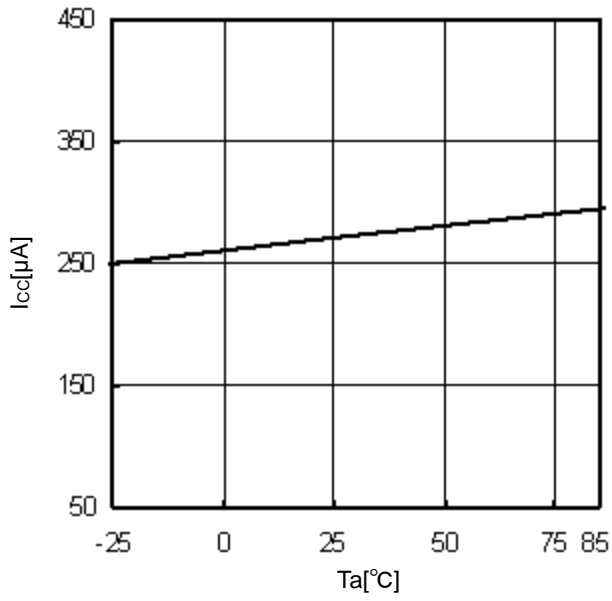

Fig.11
T_a-I_{cc}

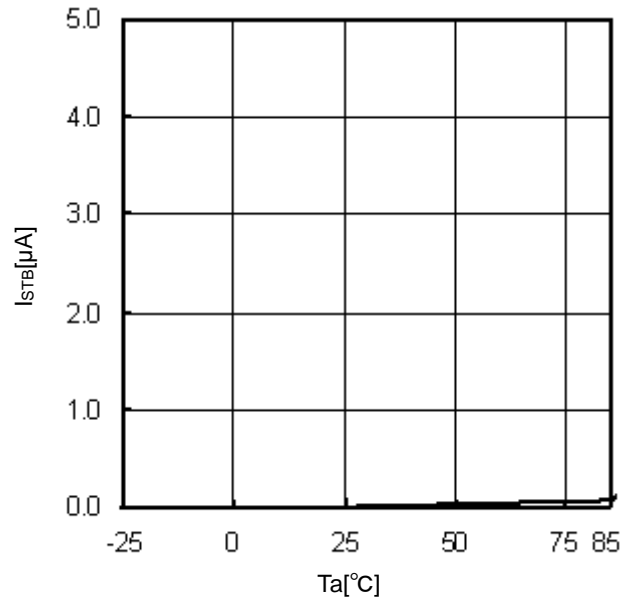

Fig.12
T_a-I_{STB} (V_{EN}=0V)

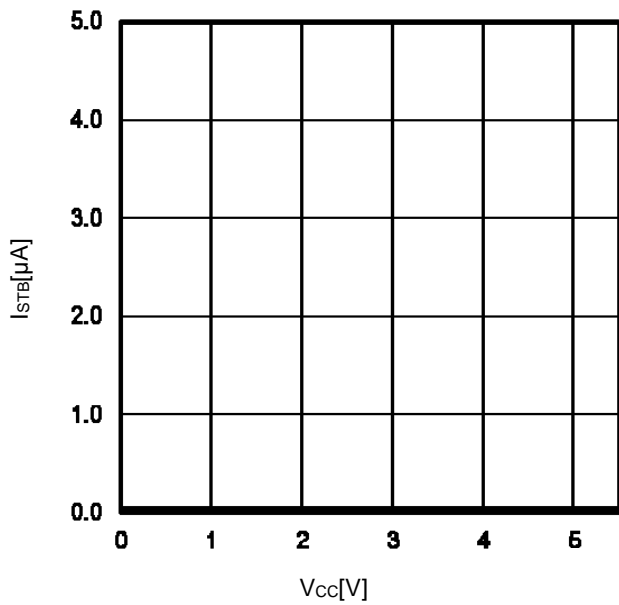

Fig.13
V_{CC}-I_{STB} (V_{EN}=0V)

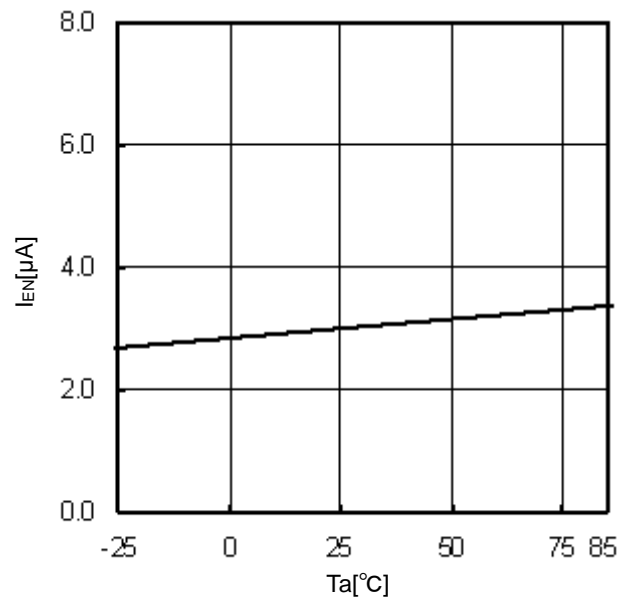

Fig.14
T_a-I_{EN}

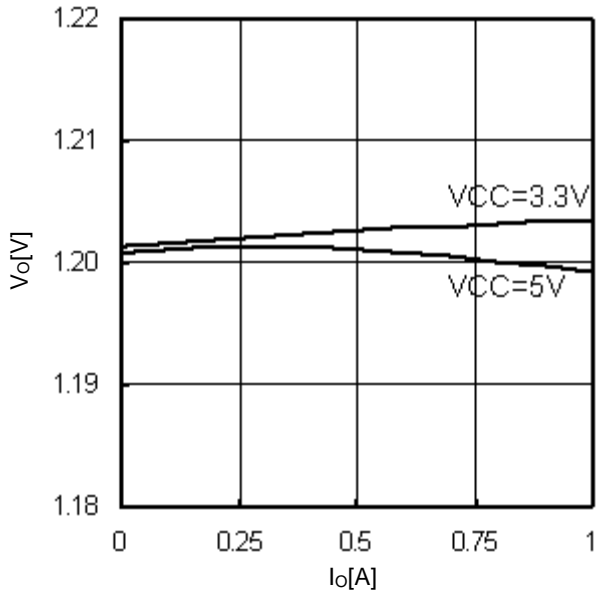

Fig.15
 I_o - V_o ($V_o = 1.2V$)

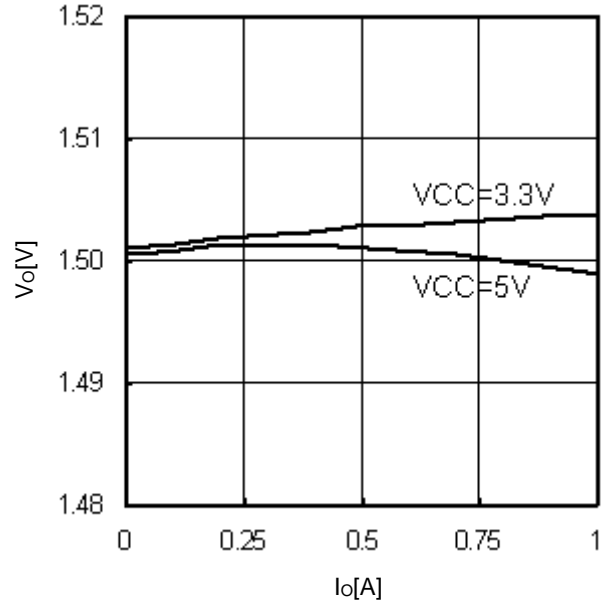

Fig.16
 I_o - V_o ($V_o = 1.5V$)

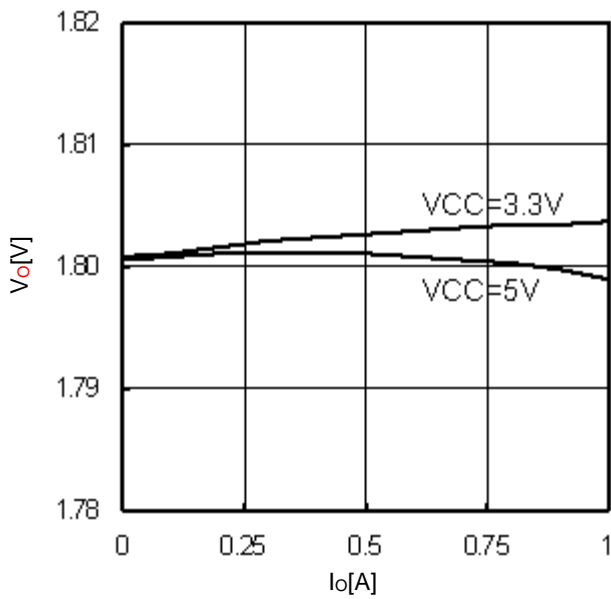

Fig.17
 I_o - V_o ($V_o = 1.8V$)

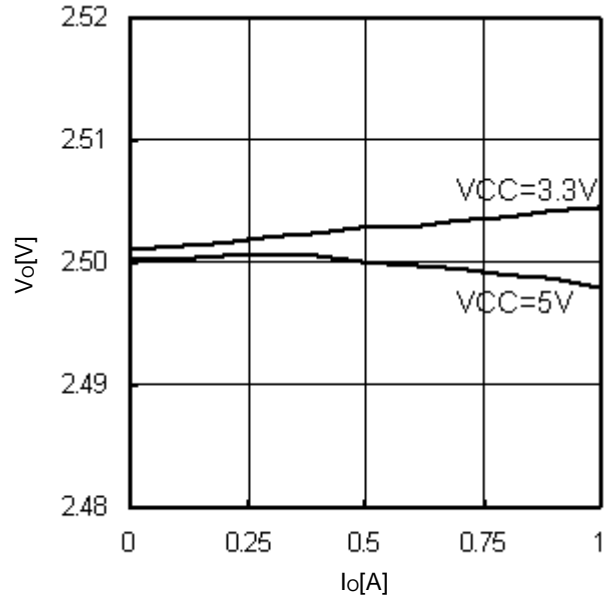

Fig.18
 I_o - V_o ($V_o = 2.5V$)

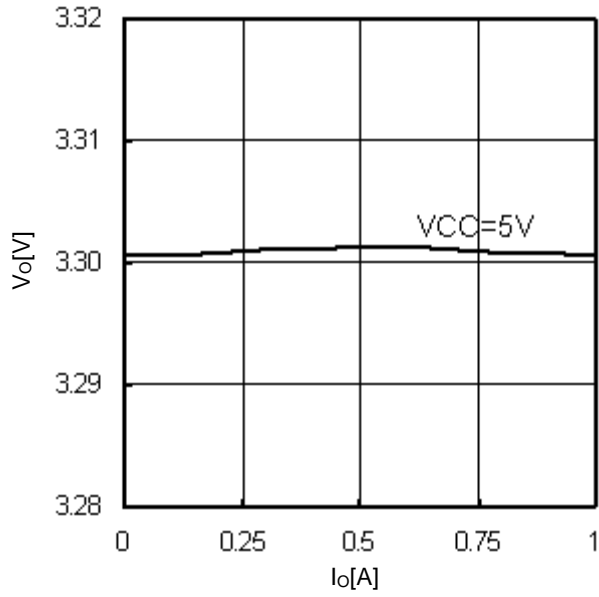

Fig.19
 I_o - V_o ($V_o=3.3V$)

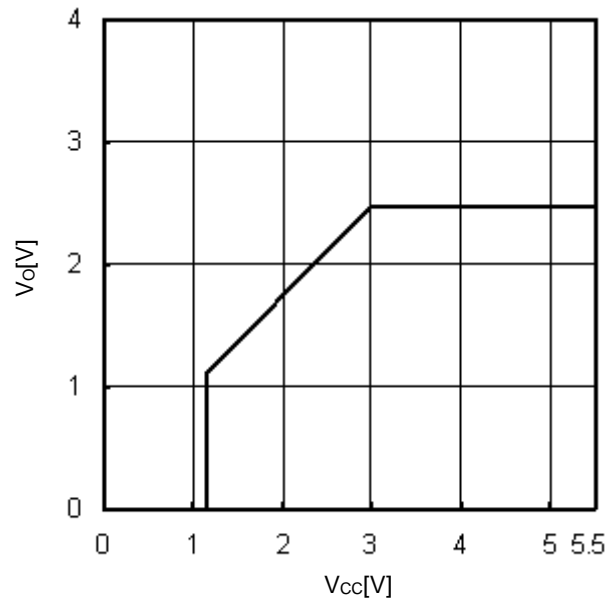

Fig.20
 V_{CC} - V_o ($I_o=0A$)

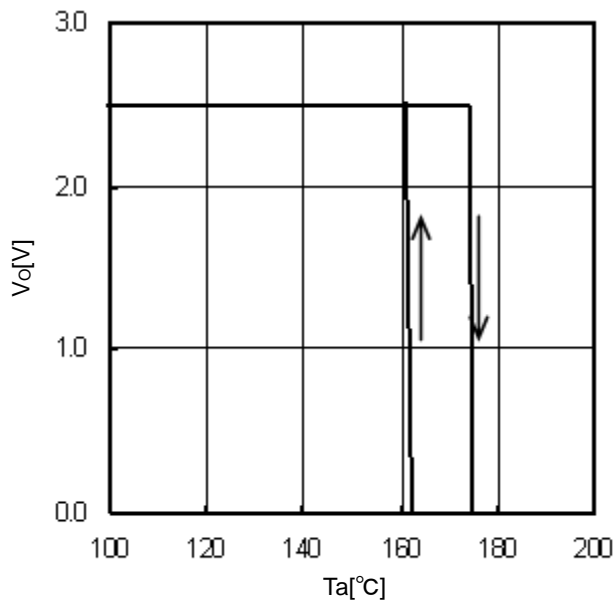

Fig.21
TSD ($I_o=0A$)

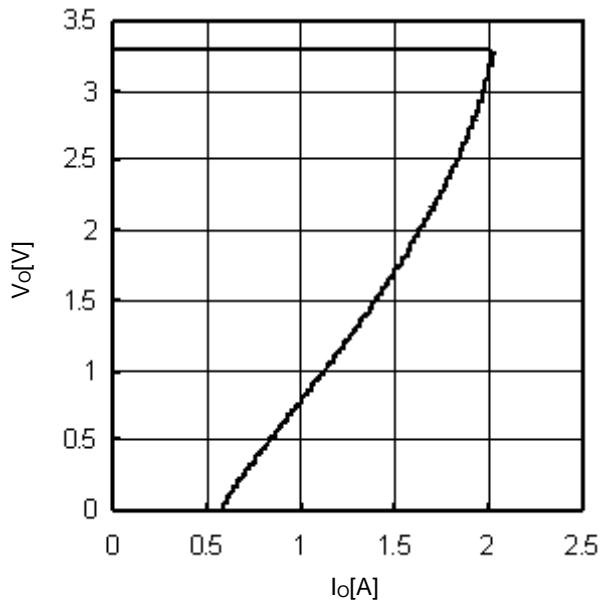

Fig.22
OCP
($V_{CC}=5V$, $V_o=3.3V$)

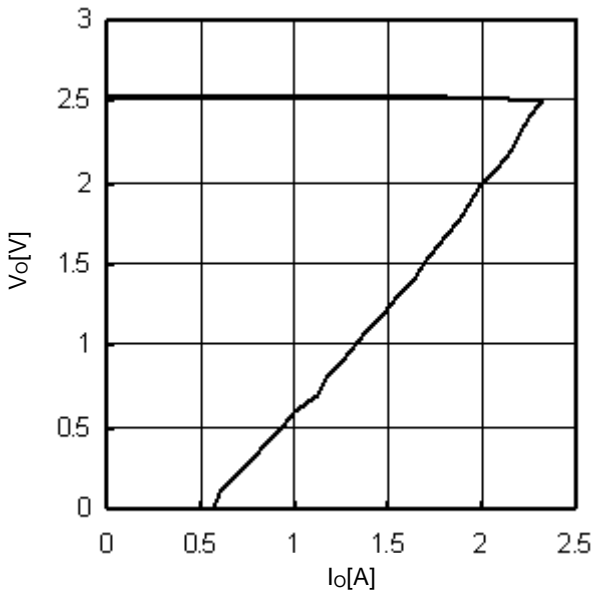

Fig.23
OCP
(V_{CC}=5V, V_O=2.5V)

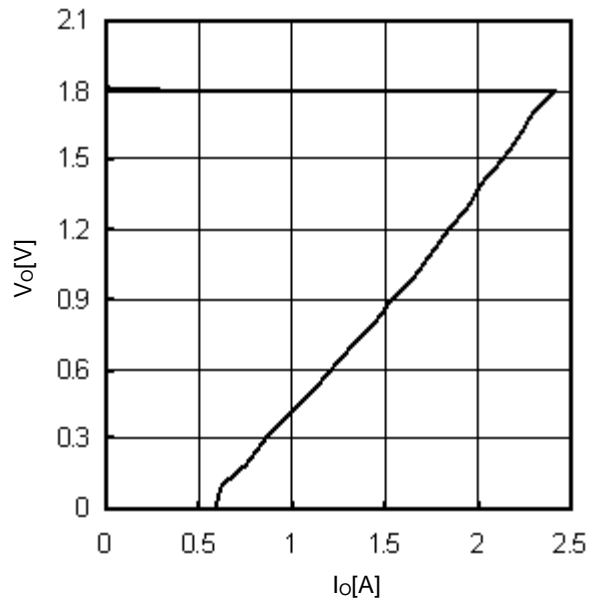

Fig.24
OCP
(V_{CC}=5V, V_O=1.8V)

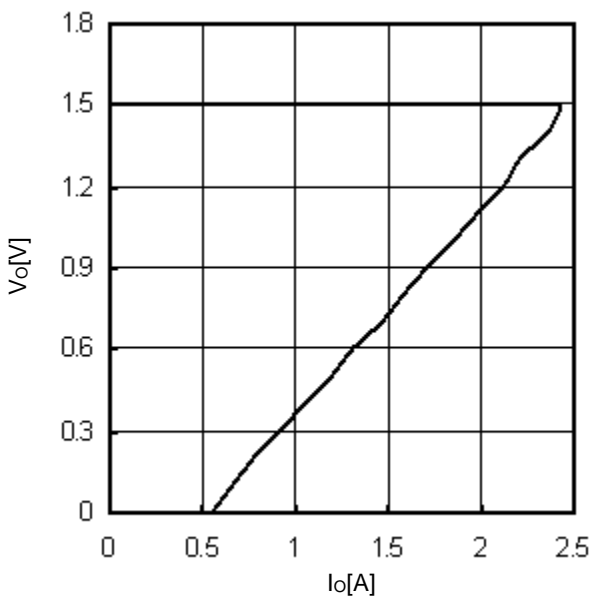

Fig.25
OCP
(V_{CC}=5V, V_O=1.5 V)

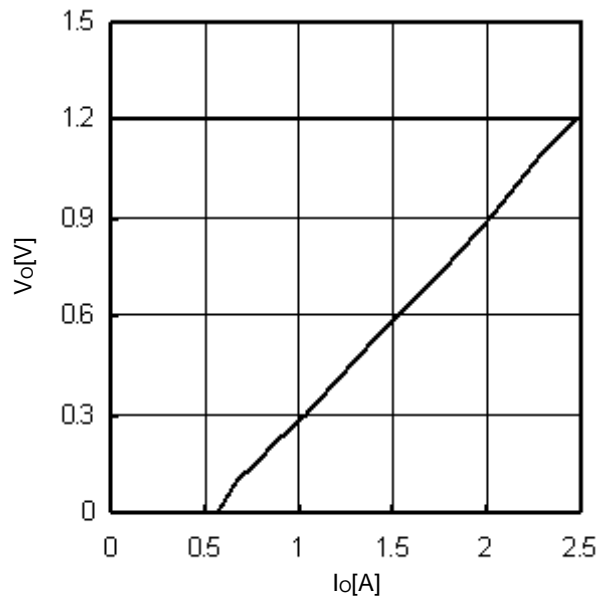

Fig.26
OCP
(V_{CC}=5V, V_O=1.2 V)

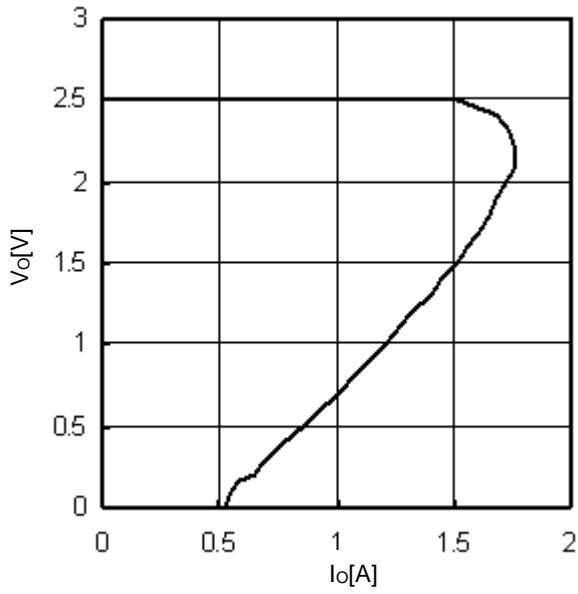

Fig.27
OCP
(Vcc=3.3V, Vo=2.5V)

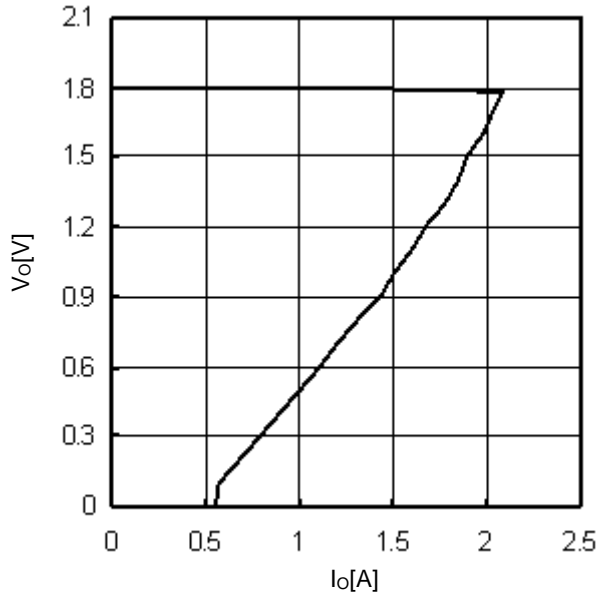

Fig.28
OCP
(Vcc=3.3V, Vo=1.8V)

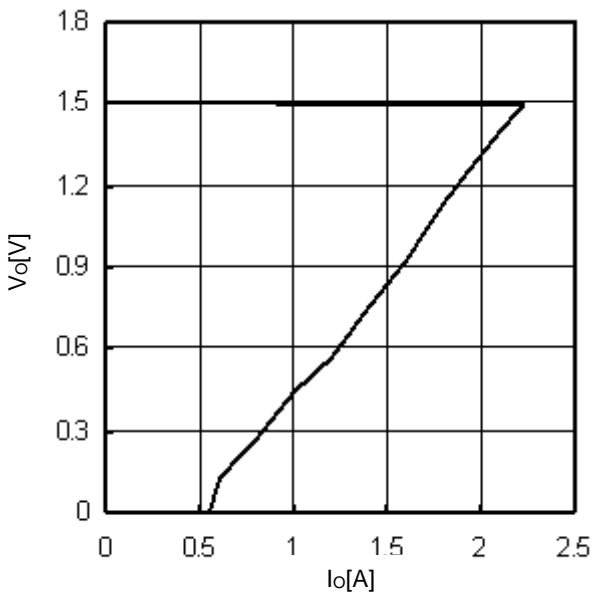

Fig.29
OCP
(Vcc=3.3V, Vo=1.5 V)

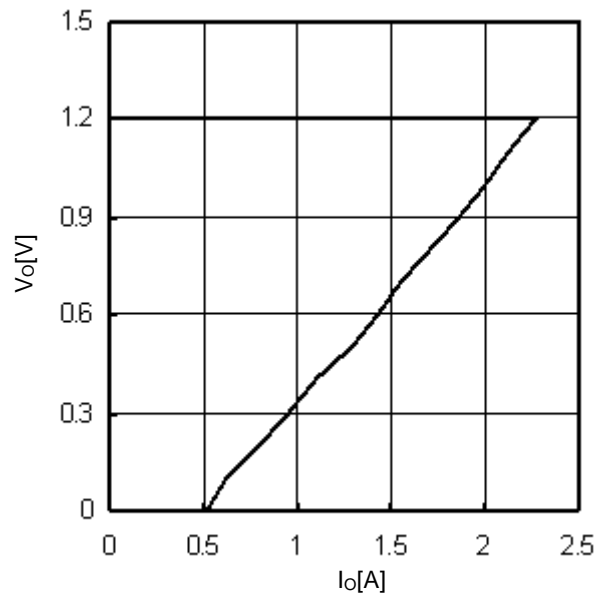

Fig.30
OCP
(Vcc=3.3V, Vo=1.2 V)

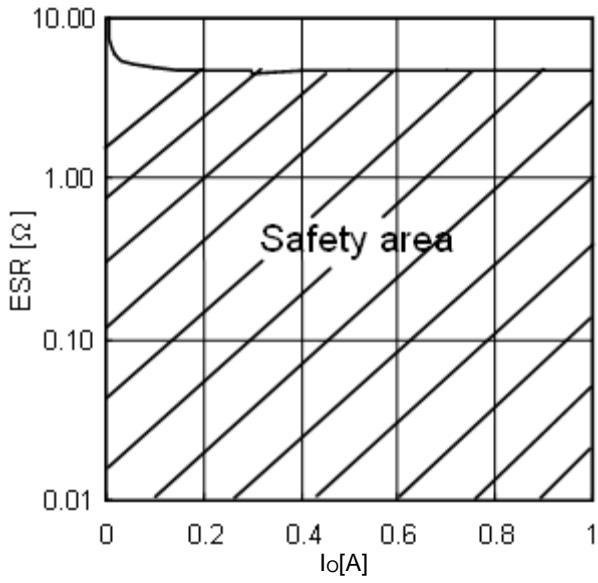

Fig.31
ESR-IO characteristics
(Co=2.2μF)

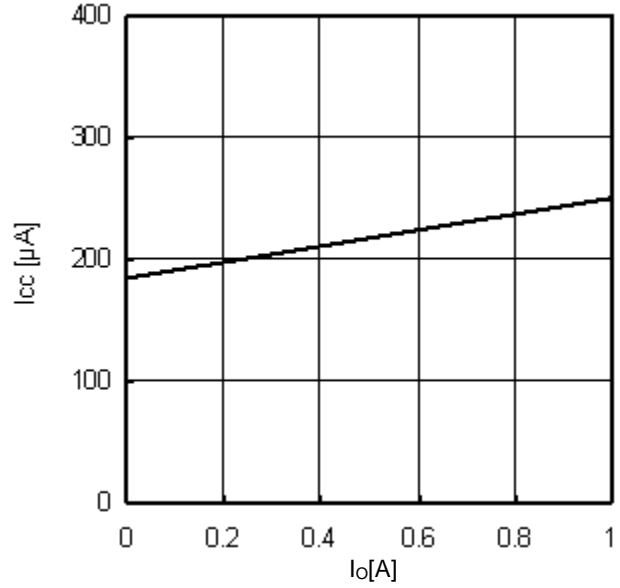

Fig.32
Io-ICC

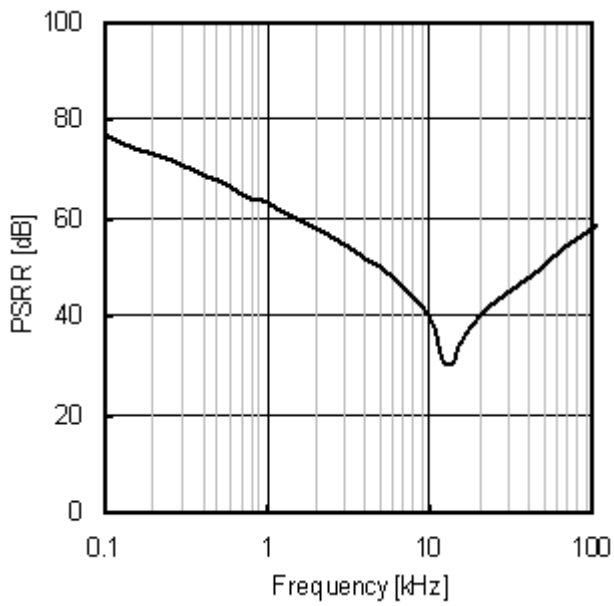

Fig.33
PSRR(Io=0A)

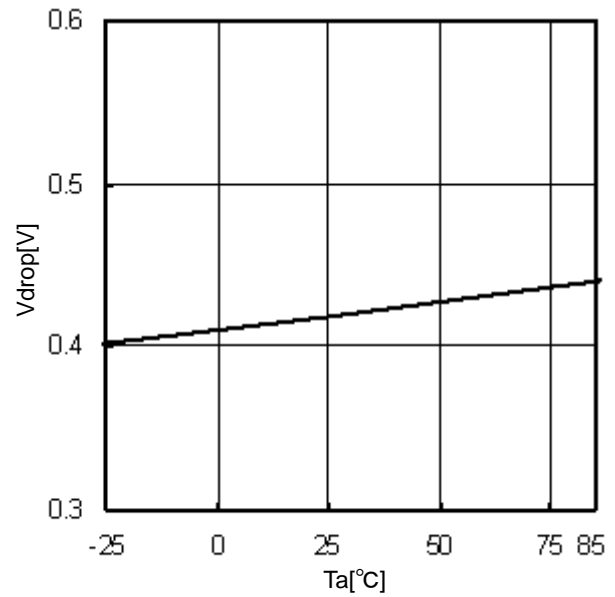

Fig.34
Minimum dropout Voltage 1
(Vcc=3.3V, Io=1.0A)

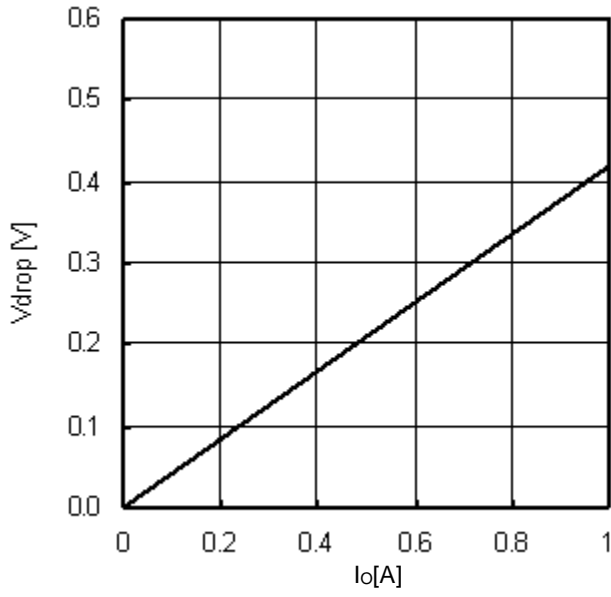

Fig.35
Minimum dropout Voltage2
(V_{cc}=2.4V)

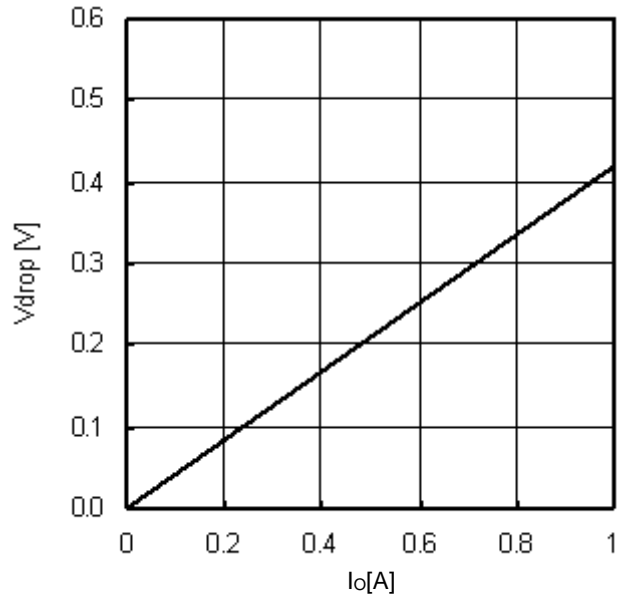

Fig.36
Minimum dropout Voltage3
(V_{cc}=3.3V)

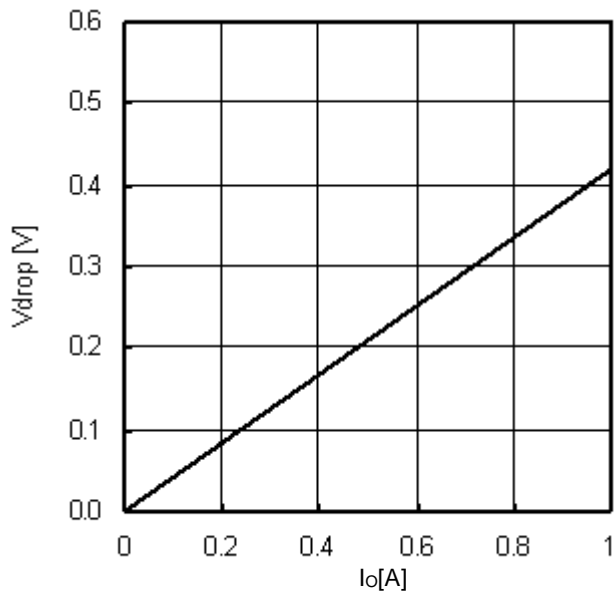
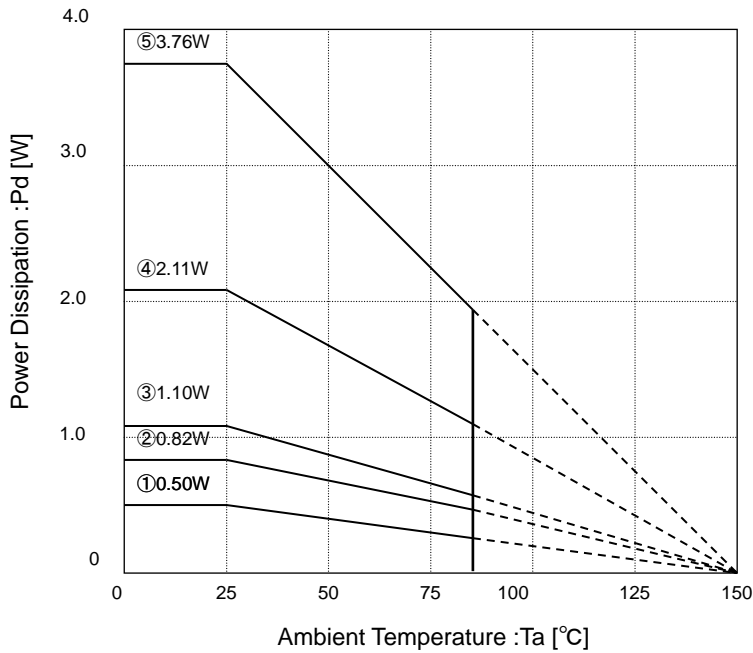

Fig.37
Minimum dropout Voltage4
(V_{cc}=5.0V)

● Power Dissipation

◎ HTSOP-J8



Measurement condition: mounted on a ROHM board,
Substrate size: 70mm × 70mm × 1.6mm
(Substrate with thermal via)
• Solder the thermal pad to Ground

- ① IC only
 $\theta_{j-a}=249.5^{\circ}\text{C/W}$
- ② 1-layer (copper foil are :0mm × 0mm)
 $\theta_{j-a}=153.2^{\circ}\text{C/W}$
- ③ 2-layer (copper foil are :15mm × 15mm)
 $\theta_{j-a}=113.6^{\circ}\text{C/W}$
- ④ 2-layer (copper foil are :70mm × 70mm)
 $\theta_{j-a}=59.2^{\circ}\text{C/W}$
- ⑤ 4-layer (copper foil are :70mm × 70mm)
 $\theta_{j-a}=33.3^{\circ}\text{C/W}$

◎ HVSO6

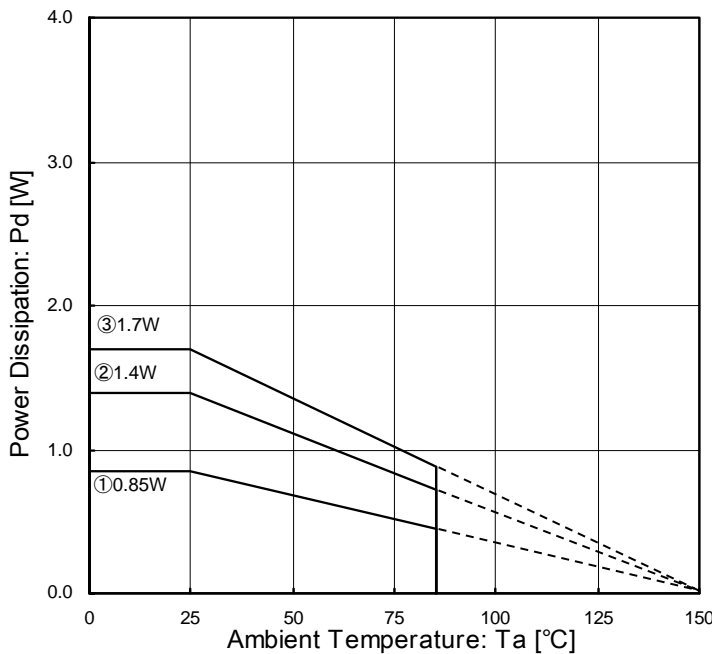

Measurement condition: mounted on a ROHM board,
Substrate size: 70mm × 70mm × 1.6mm
(Substrate with thermal via)
• Solder the thermal pad to Ground

- ① single-layer(copper foil are :2%)
 $\theta_{j-a}=147.1^{\circ}\text{C/W}$
- ② single-layer(copper foil are :18%)
 $\theta_{j-a}=89.3^{\circ}\text{C/W}$
- ③ single-layer(copper foil are :51%)
 $\theta_{j-a}=73.5^{\circ}\text{C/W}$

Thermal design should ensure operation within the following conditions. Note that the temperatures listed are the allowed temperature limits and thermal design should allow sufficient margin beyond these limits.

1. Ambient temperature T_a can be no higher than 85°C.
2. Chip junction temperature (T_j) can be no higher than 150°C.

Chip junction temperature can be determined as follows:

Calculation based on ambient temperature (T_a)

$$T_j = T_a + \theta_{j-a} \times P$$

<Reference values>

θ_{j-a} :	HTSOP-J8	153.2°C/W	1-layer substrate (copper foil density 0mm × 0mm)
		113.6°C/W	2-layer substrate (copper foil density 15mm × 15mm)
		59.2°C/W	2-layer substrate (copper foil density 70mm × 70mm)
		33.3°C/W	4-layer substrate (copper foil density 70mm × 70mm)
Substrate size: 70mm × 70mm × 1.6mm (substrate with thermal via)			

Most of the heat loss that occurs in the BDxxIC0W series is generated from the output Pch FET. Power loss is determined by the total $V_{CC} - V_O$ voltage and output current. Be sure to confirm the system input and output voltage as well as the output current conditions in relation to the heat dissipation characteristics of the V_{CC} and V_O in the design. Bearing in mind that heat dissipation may vary substantially depending on the substrate employed (due to the power package incorporated in the BDxxIC0W series) make certain to factor conditions such as substrate size into the thermal design.

$$\text{Power consumption [W]} = \{ \text{Input voltage (} V_{CC} \text{) - Output voltage (} V_O \text{)} \} \times I_o(\text{Ave})$$

Example) When $V_{CC}=3.3V$, $V_O=2.5V$, $I_o(\text{Ave}) = 0.1A$

$$\begin{aligned} \text{Power consumption [W]} &= \{ 3.3V - 2.5V \} \times 0.1A \\ &= 0.08[W] \end{aligned}$$

●Input-to-Output Capacitor

It is recommended that a capacitor (over 1uF) is placed near pins between the input pin and GND as well as the output pin and GND. A capacitor, between input pin and GND, is valid when the power supply impedance is high or trace is long. Also, as for the capacitor between the output pin and GND, the greater the capacitance, the more sustainable the line regulation will be and the capacitor will make improvements of characteristics depending on the load. However, please check the actual functionality of this part by mounting it on a board for the actual application. Ceramic capacitors usually have different, thermal and equivalent series resistance characteristics, and moreover capacitance decreases gradually in use. For additional details, please check with the manufacturer, and select the best ceramic capacitor for your application.

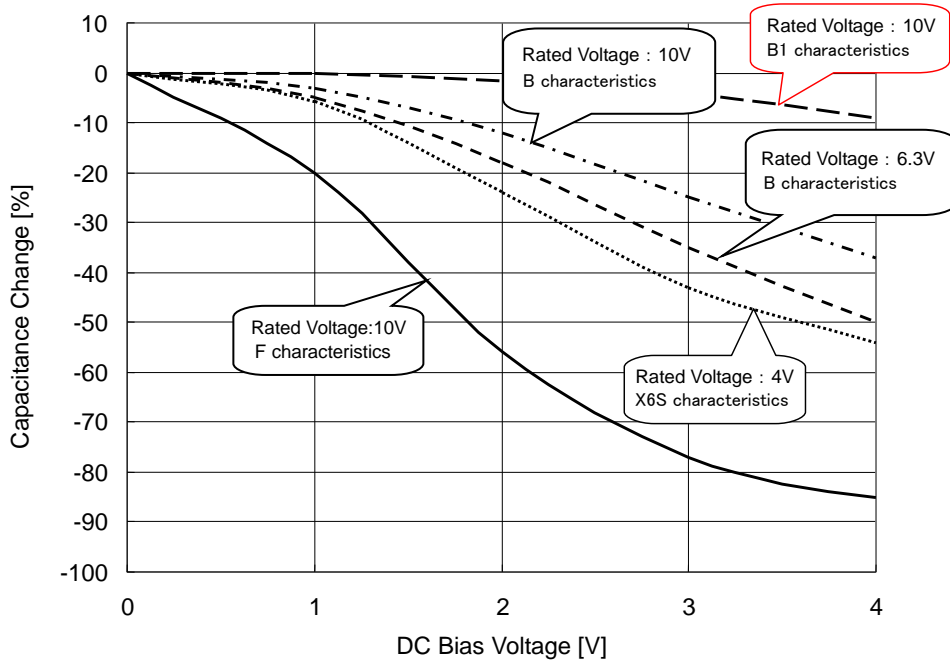

Ceramic capacitor capacity – DC bias characteristics (Characteristics example)

●Equivalent Series Resistance ESR (Output Capacitor)

To prevent oscillations, please attach a capacitor between V_O and GND. Capacitors usually have ESR (Equivalent Series Resistance). Operation will be stable in the ESR- I_o range shown to the right. This reference data condition is 1.0uF Ceramic capacitor and resistor are connected to output in series. Ceramic, tantalum and electrolytic Capacitors have different ESR values, so please ensure that you are using a capacitor that operates in the stable operating region shown on the right. Finally, please evaluate in the actual application.

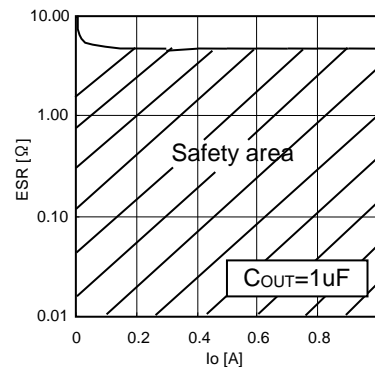

ESR – I_o characteristics

●Evaluation Board Circuit

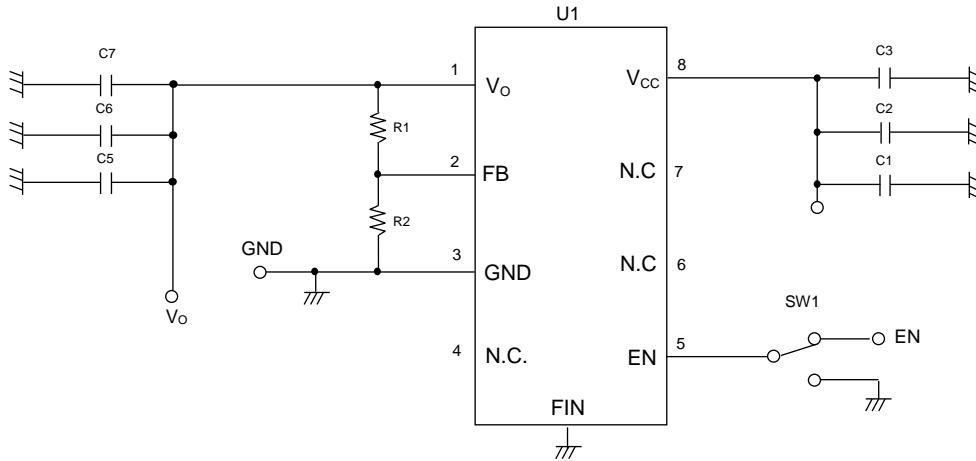

●Evaluation Board Parts List

Designation	Value	Part No.	Company	Designation	Value	Part No.	Company
R1	16kΩ	MCR01PZPZF1602	ROHM	C4	-	-	-
R2	7.5kΩ	MCR01PZPZF7501	ROHM	C5	1μF	CM105B105K10A	KYOCERA
R3	-	-	-	C6	-	-	-
R4	-	-	-	C7	-	-	-
R5	-	-	-	C8	-	-	-
R6	-	-	-	C9	-	-	-
C1	1μF	CM105B105K16A	KYOCERA	C10	-	-	-
C2	-	-	-	U1	-	BD00IC0WEFJ	ROHM
C3	-	-	-	U2	-	-	-

●Board Layout

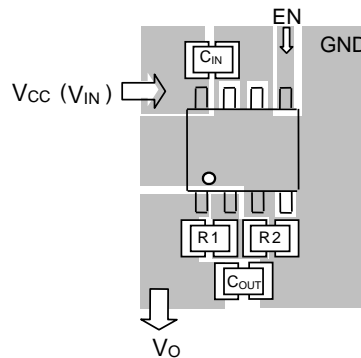

PCB layout considerations:

- Input capacitor C_{IN} connected to V_{CC} (V_{IN}) should be placed as close to $V_{CC}(V_{IN})$ pin as possible. Output capacitor C_{OUT} also should be placed as close to IC pin as possible. In case the part is connected to inner layer GND plane, please use several through holes.
- FB pin has comparatively high impedance and can be affected by noise, so stray capacitance should be as small as possible. Please take care of this during layout.
- Please make GND pattern wide enough to handle thermal dissipation.
- For output voltage setting
Output voltage can be set by FB pin voltage (0.800V typ.) and external resistance R1, R2.

$$V_O = V_{FB} \times \frac{R_1 + R_2}{R_2}$$

(The use of resistors with $R_1 + R_2 = 1k$ to $90k$ is recommended)

● I/O Equivalent Circuits (Variable type : BD00IC0WEFJ)

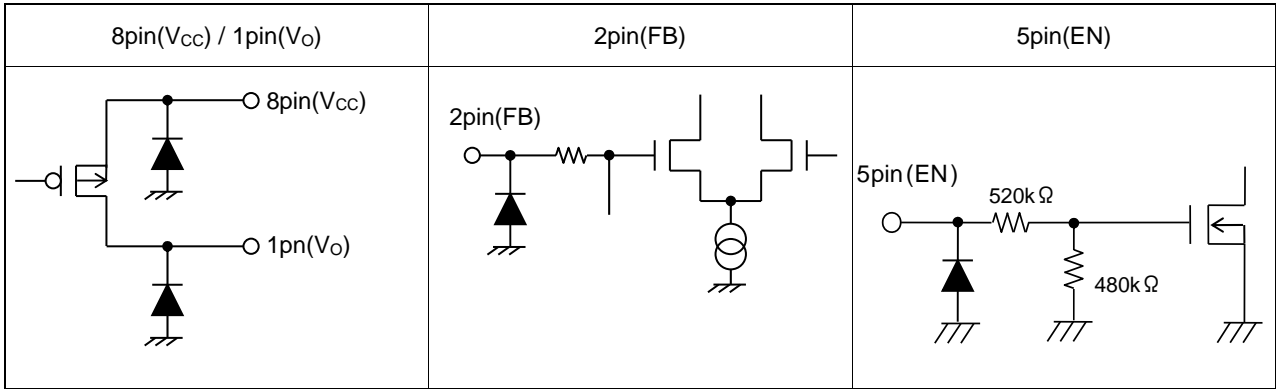

● I/O Equivalent Circuits (Fixed type : BDxxIC0WEFJ)

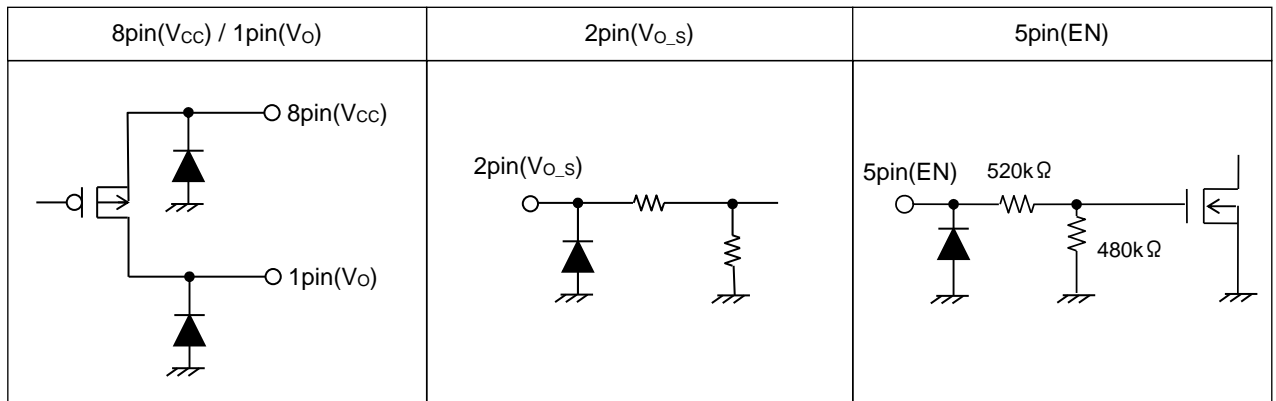

● I/O Equivalent Circuits (Variable type : BD00IC0WHFV)

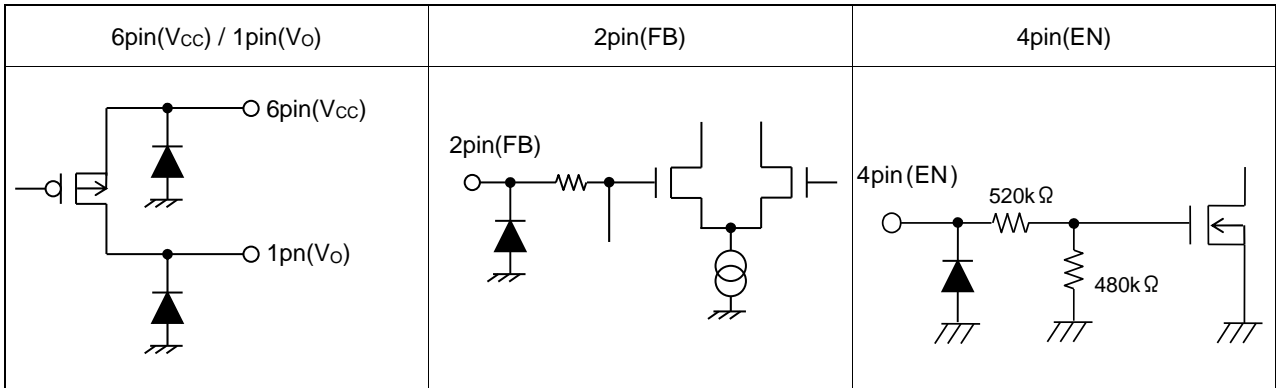

● I/O Equivalent Circuits (Fixed type : BDxxIC0WHFV)

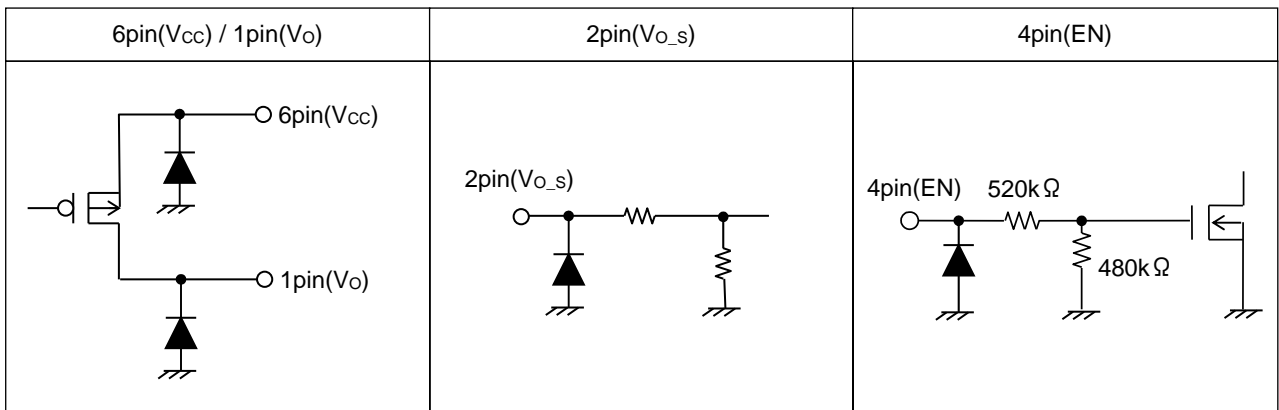

●Operational Notes

- (1) Absolute maximum ratings
An excess in the absolute maximum ratings, such as supply voltage, temperature range of operating conditions, etc., can break down the device, thus making it impossible to identify the damage mode, such as a short circuit or an open circuit. If there is any possibility of exposure over the rated values, please consider adding circuit protection devices such as fuses.
- (2) Connecting the power supply connector backward
Connecting of the power supply in reverse polarity can damage the IC. Take precautions when connecting the power supply lines. An external direction diode can be added.
- (3) Power supply lines
Design the PCB layout pattern to provide low impedance GND and supply lines. To obtain a low noise ground and supply line, separate the ground section and supply lines of the digital and analog blocks. Furthermore, for all power supply terminals to ICs, connect a capacitor between the power supply and GND terminal. When using electrolytic capacitors in a circuit, note that capacitance values are reduced at low temperatures and over time.
- (4) GND voltage
The potential of the GND pin must be minimum potential under all operating conditions.
- (5) Thermal design
Use a thermal design that allows for a sufficient margin in light of the power dissipation (Pd) in actual operating conditions.
- (6) Off-leakage at high temperature.
Off-leakage at high temperature may increase because of manufacturing variations. Design should consider the typical & worst cases shown below.

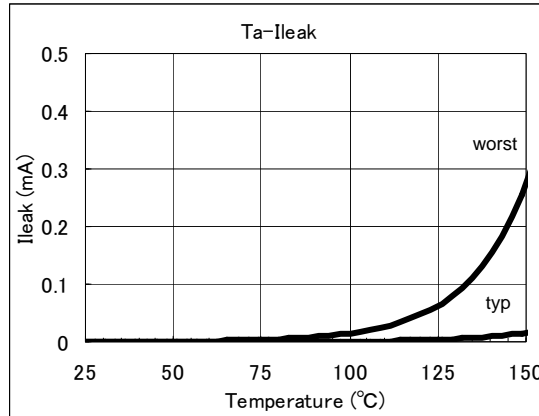

- (7) Inter-pin shorts and mounting errors
Use caution when positioning the IC for mounting on printed circuit boards. The IC may be damaged if there is any connection error or if pins are shorted together.
- (8) Actions in strong electromagnetic field
Use caution when using the IC in the presence of a strong electromagnetic field as doing so may cause the IC to malfunction.
- (9) ASO
When using the IC, set the output transistor so that it does not exceed absolute maximum ratings or ASO.
- (10) Thermal shutdown circuit
The IC incorporates a built-in thermal shutdown circuit (TSD circuit). The thermal shutdown circuit (TSD circuit) is designed only to shut the IC off to prevent thermal runaway. It is not designed to protect the IC or guarantee its operation. Do not continue to use the IC after operating this circuit or use the IC in an environment where the operation of this circuit is assumed.

	TSD ON Temperature[°C] (typ.)	Hysteresis Temperature [°C] (typ.)
BDxxIC0W series	175	15

(11) Testing on application boards

When testing the IC on an application board, connecting a capacitor to a pin with low impedance subjects the IC to stress. Always discharge capacitors after each process or step. Always turn the IC's power supply off before connecting it to or removing it from a jig or fixture during the inspection process. Ground the IC during assembly steps as an antistatic measure. Use similar precaution when transporting or storing the IC.

(12) Regarding input pin of the IC

This monolithic IC contains P+ isolation and P substrate layers between adjacent elements in order to keep them isolated. P-N junctions are formed at the intersection of these P layers with the N layers of other elements, creating a parasitic diode or transistor. For example, the relation between each potential is as follows:

When $GND > Pin A$ and $GND > Pin B$, the P-N junction operates as a parasitic diode.

When $GND > Pin B$, the P-N junction operates as a parasitic transistor.

Parasitic diodes can occur inevitable in the structure of the IC. The operation of parasitic diodes can result in mutual interference among circuits, operational faults, or physical damage. Accordingly, methods by which parasitic diodes operate, such as applying a voltage that is lower than the GND (P substrate) voltage to an input pin, should not be used.

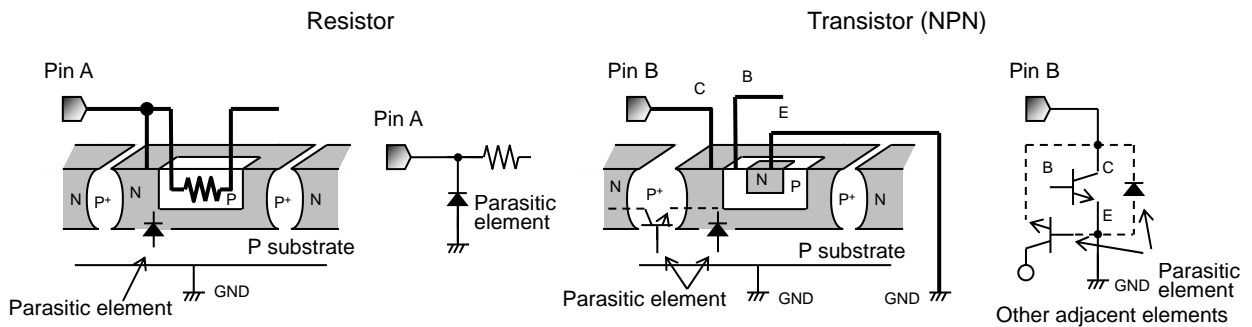

(13) Ground Wiring Pattern.

When using both small signal and large current GND patterns, it is recommended to isolate the two ground patterns, placing a single ground point at the ground potential of application so that the pattern wiring resistance and voltage variations caused by large currents do not cause variations in the small signal ground voltage. Be careful not to change the GND wiring pattern of any external components, either.

●Physical Dimension Tape and Reel Information

HTSOP-J8

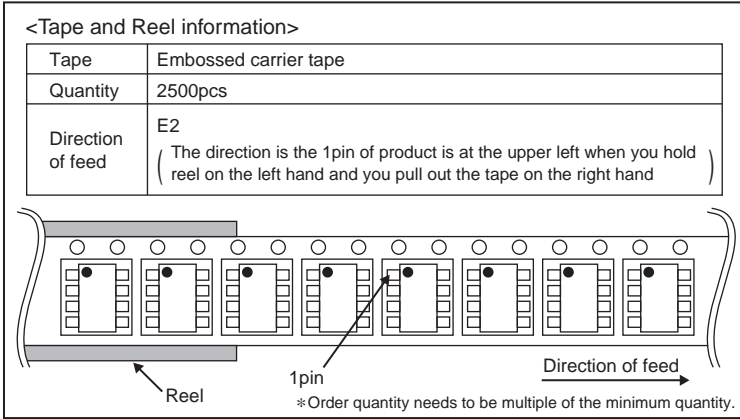
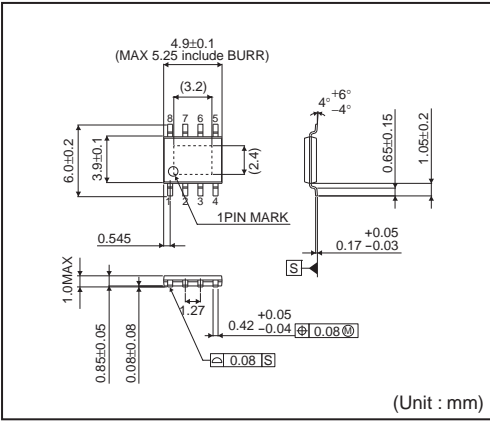

HVSOF6

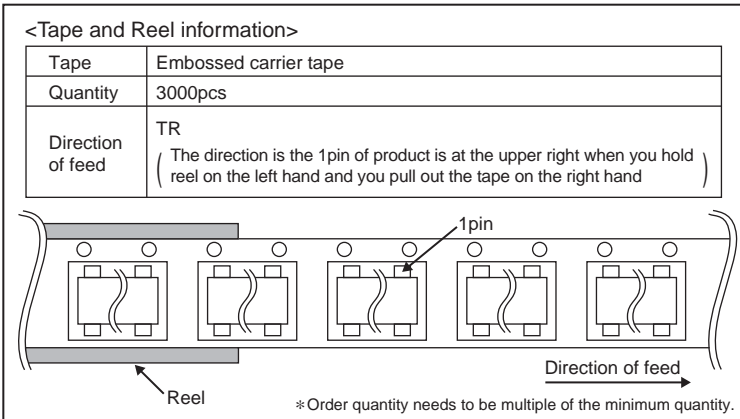
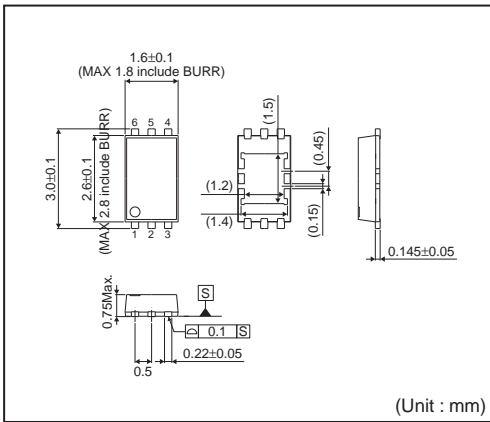

●Marking Diagram

HTSOP-J8(TOP VIEW)

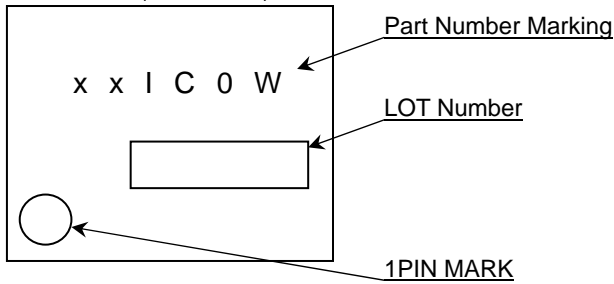

xx	Product Name
00	BD00IC0WEFJ
10	BD10IC0WEFJ
12	BD12IC0WEFJ
15	BD15IC0WEFJ
18	BD18IC0WEFJ
25	BD25IC0WEFJ
30	BD30IC0WEFJ
33	BD33IC0WEFJ

HVSOF6(TOP VIEW)

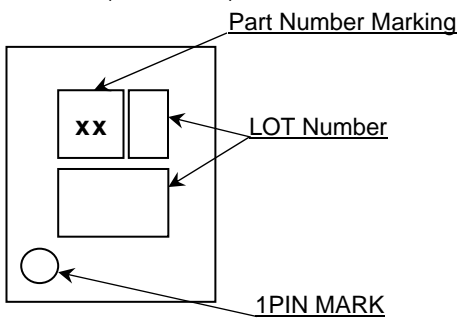

xx	Product Name
B0	BD00IC0WHFV
BT	BD10IC0WHFV
BU	BD12IC0WHFV
BS	BD1CIC0WHFV
BV	BD15IC0WHFV
BW	BD18IC0WHFV
BX	BD25IC0WHFV
BR	BD26IC0WHFV
BY	BD30IC0WHFV
BZ	BD33IC0WHFV

●Revision History

Date	Revision	Changes
6.Jul.2012	001	New Release.
21.Dec.2012	002	The description was modified.
24.Sep.2014	003	The power dissipation data was added.
19.Aug.2015	004	P5 modify Absolute Maximum Ratings (Power supply voltage and EN voltage)

Notice

Precaution on using ROHM Products

- Our Products are designed and manufactured for application in ordinary electronic equipments (such as AV equipment, OA equipment, telecommunication equipment, home electronic appliances, amusement equipment, etc.). If you intend to use our Products in devices requiring extremely high reliability (such as medical equipment ^(Note 1), transport equipment, traffic equipment, aircraft/spacecraft, nuclear power controllers, fuel controllers, car equipment including car accessories, safety devices, etc.) and whose malfunction or failure may cause loss of human life, bodily injury or serious damage to property ("Specific Applications"), please consult with the ROHM sales representative in advance. Unless otherwise agreed in writing by ROHM in advance, ROHM shall not be in any way responsible or liable for any damages, expenses or losses incurred by you or third parties arising from the use of any ROHM's Products for Specific Applications.

(Note1) Medical Equipment Classification of the Specific Applications

JAPAN	USA	EU	CHINA
CLASS III	CLASS III	CLASS II b	CLASS III
CLASS IV		CLASS III	

- ROHM designs and manufactures its Products subject to strict quality control system. However, semiconductor products can fail or malfunction at a certain rate. Please be sure to implement, at your own responsibilities, adequate safety measures including but not limited to fail-safe design against the physical injury, damage to any property, which a failure or malfunction of our Products may cause. The following are examples of safety measures:
 - Installation of protection circuits or other protective devices to improve system safety
 - Installation of redundant circuits to reduce the impact of single or multiple circuit failure
- Our Products are designed and manufactured for use under standard conditions and not under any special or extraordinary environments or conditions, as exemplified below. Accordingly, ROHM shall not be in any way responsible or liable for any damages, expenses or losses arising from the use of any ROHM's Products under any special or extraordinary environments or conditions. If you intend to use our Products under any special or extraordinary environments or conditions (as exemplified below), your independent verification and confirmation of product performance, reliability, etc. prior to use, must be necessary:
 - Use of our Products in any types of liquid, including water, oils, chemicals, and organic solvents
 - Use of our Products outdoors or in places where the Products are exposed to direct sunlight or dust
 - Use of our Products in places where the Products are exposed to sea wind or corrosive gases, including Cl₂, H₂S, NH₃, SO₂, and NO₂
 - Use of our Products in places where the Products are exposed to static electricity or electromagnetic waves
 - Use of our Products in proximity to heat-producing components, plastic cords, or other flammable items
 - Sealing or coating our Products with resin or other coating materials
 - Use of our Products without cleaning residue of flux (even if you use no-clean type fluxes, cleaning residue of flux is recommended); or Washing our Products by using water or water-soluble cleaning agents for cleaning residue after soldering
 - Use of the Products in places subject to dew condensation
- The Products are not subject to radiation-proof design.
- Please verify and confirm characteristics of the final or mounted products in using the Products.
- In particular, if a transient load (a large amount of load applied in a short period of time, such as pulse. is applied, confirmation of performance characteristics after on-board mounting is strongly recommended. Avoid applying power exceeding normal rated power; exceeding the power rating under steady-state loading condition may negatively affect product performance and reliability.
- De-rate Power Dissipation (Pd) depending on Ambient temperature (Ta). When used in sealed area, confirm the actual ambient temperature.
- Confirm that operation temperature is within the specified range described in the product specification.
- ROHM shall not be in any way responsible or liable for failure induced under deviant condition from what is defined in this document.

Precaution for Mounting / Circuit board design

- When a highly active halogenous (chlorine, bromine, etc.) flux is used, the residue of flux may negatively affect product performance and reliability.
- In principle, the reflow soldering method must be used on a surface-mount products, the flow soldering method must be used on a through hole mount products. If the flow soldering method is preferred on a surface-mount products, please consult with the ROHM representative in advance.

For details, please refer to ROHM Mounting specification

Precautions Regarding Application Examples and External Circuits

1. If change is made to the constant of an external circuit, please allow a sufficient margin considering variations of the characteristics of the Products and external components, including transient characteristics, as well as static characteristics.
2. You agree that application notes, reference designs, and associated data and information contained in this document are presented only as guidance for Products use. Therefore, in case you use such information, you are solely responsible for it and you must exercise your own independent verification and judgment in the use of such information contained in this document. ROHM shall not be in any way responsible or liable for any damages, expenses or losses incurred by you or third parties arising from the use of such information.

Precaution for Electrostatic

This Product is electrostatic sensitive product, which may be damaged due to electrostatic discharge. Please take proper caution in your manufacturing process and storage so that voltage exceeding the Products maximum rating will not be applied to Products. Please take special care under dry condition (e.g. Grounding of human body / equipment / solder iron, isolation from charged objects, setting of Ionizer, friction prevention and temperature / humidity control).

Precaution for Storage / Transportation

1. Product performance and soldered connections may deteriorate if the Products are stored in the places where:
 - [a] the Products are exposed to sea winds or corrosive gases, including Cl₂, H₂S, NH₃, SO₂, and NO₂
 - [b] the temperature or humidity exceeds those recommended by ROHM
 - [c] the Products are exposed to direct sunshine or condensation
 - [d] the Products are exposed to high Electrostatic
2. Even under ROHM recommended storage condition, solderability of products out of recommended storage time period may be degraded. It is strongly recommended to confirm solderability before using Products of which storage time is exceeding the recommended storage time period.
3. Store / transport cartons in the correct direction, which is indicated on a carton with a symbol. Otherwise bent leads may occur due to excessive stress applied when dropping of a carton.
4. Use Products within the specified time after opening a humidity barrier bag. Baking is required before using Products of which storage time is exceeding the recommended storage time period.

Precaution for Product Label

QR code printed on ROHM Products label is for ROHM's internal use only.

Precaution for Disposition

When disposing Products please dispose them properly using an authorized industry waste company.

Precaution for Foreign Exchange and Foreign Trade act

Since concerned goods might be fallen under listed items of export control prescribed by Foreign exchange and Foreign trade act, please consult with ROHM in case of export.

Precaution Regarding Intellectual Property Rights

1. All information and data including but not limited to application example contained in this document is for reference only. ROHM does not warrant that foregoing information or data will not infringe any intellectual property rights or any other rights of any third party regarding such information or data.
2. ROHM shall not have any obligations where the claims, actions or demands arising from the combination of the Products with other articles such as components, circuits, systems or external equipment (including software).
3. No license, expressly or implied, is granted hereby under any intellectual property rights or other rights of ROHM or any third parties with respect to the Products or the information contained in this document. Provided, however, that ROHM will not assert its intellectual property rights or other rights against you or your customers to the extent necessary to manufacture or sell products containing the Products, subject to the terms and conditions herein.

Other Precaution



1. This document may not be reprinted or reproduced, in whole or in part, without prior written consent of ROHM.
2. The Products may not be disassembled, converted, modified, reproduced or otherwise changed without prior written consent of ROHM.
3. In no event shall you use in any way whatsoever the Products and the related technical information contained in the Products or this document for any military purposes, including but not limited to, the development of mass-destruction weapons.
4. The proper names of companies or products described in this document are trademarks or registered trademarks of ROHM, its affiliated companies or third parties.

General Precaution

1. Before you use our Products, you are requested to carefully read this document and fully understand its contents. ROHM shall not be in any way responsible or liable for failure, malfunction or accident arising from the use of any ROHM's Products against warning, caution or note contained in this document.
2. All information contained in this document is current as of the issuing date and subject to change without any prior notice. Before purchasing or using ROHM's Products, please confirm the latest information with a ROHM sales representative.
3. The information contained in this document is provided on an "as is" basis and ROHM does not warrant that all information contained in this document is accurate and/or error-free. ROHM shall not be in any way responsible or liable for any damages, expenses or losses incurred by you or third parties resulting from inaccuracy or errors of or concerning such information.

Looking for pricing, stock, or lifecycle information?

Click below to explore more details on WIN SOURCE:

-  [View BD12IC0WHFV-GTR on WIN SOURCE](#)
-  [Rohm Semiconductor](#) Information

Optimize Your Supply Chain with WIN SOURCE Solutions

-  Global Sourcing Solution
-  Obsolete Management
-  Cost Control Management
-  Shortage Management
-  Alternative Solution
-  Excess Inventory Management