



# THE DATASHEET OF BLF989U



# BLF989; BLF989S

UHF power LDMOS transistor

Rev. 3 — 24 May 2019

AMPLEON

Product data sheet

## 1. Product profile

### 1.1 General description

A 900 W LDMOS RF power transistor for broadcast Doherty, class-AB transmitter and industrial applications. The excellent ruggedness of this device makes it ideal for digital and analog transmitter applications in the frequency range from 400 MHz to 860 MHz.

**Table 1. Application information**

RF performance at  $V_{DS} = 50$  V in a class-AB broadband application demo, unless otherwise specified.

Test signal	f (MHz)	$V_{DS}$ (V)	$P_{L(AV)}$ (W)	$G_p$ (dB)	$\eta_D$ (%)	IMD <sub>shldr</sub> (dBc)	PAR (dB)
class-AB broadband/DVB-T (8k OFDM)	470 to 710	50	150	20	34	-30	8.2 [1]
symmetric Doherty/DVB-T (8k OFDM) [2][3]	470 to 500	50	300	19	50	-37	-
symmetric Doherty/DVB-T (8k OFDM) [4][5]	474 to 490	50	200	19	53	-41	-

[1] PAR (of output signal) at 0.01 % probability on CCDF; PAR of input signal = 9.5 dB at 0.01 % probability on CCDF.

[2] ProTelevision 3000 Exciter corrected DVB-T.

[3] Narrowband classical Doherty application using two transistors.

[4] Anywave CTTB exciter XS.

[5] Narrowband Doherty using one transistor.

### 1.2 Features and benefits

- Designed for broadband and Doherty operation
- High efficiency
- Integrated dual sided ESD protection
- Excellent ruggedness
- High power gain
- Excellent reliability
- Easy power control
- Excellent stability
- For RoHS compliance see the product details on the Ampleon website

### 1.3 Applications

- Broadcast transmitter applications in the UHF band
- Digital and analog broadcasting
- Industrial, scientific and medical applications
- Applicable at frequencies from 400 MHz to 860 MHz

## 2. Pinning information

Table 2. Pinning

Pin	Description	Simplified outline	Graphic symbol
<b>BLF989 (SOT539A)</b>			
1	drain1		 sym117
2	drain2		
3	gate1		
4	gate2		
5	source <a href="#">[1]</a>		
<b>BLF989S (SOT539B)</b>			
1	drain1		 sym117
2	drain2		
3	gate1		
4	gate2		
5	source <a href="#">[1]</a>		

[1] Connected to flange.

## 3. Ordering information

Table 3. Ordering information

Type number	Package		
	Name	Description	Version
BLF989	-	flanged balanced ceramic package; 2 mounting holes; 4 leads	SOT539A
BLF989S	-	earless flanged balanced ceramic package; 4 leads	SOT539B

## 4. Limiting values

Table 4. Limiting values

In accordance with the Absolute Maximum Rating System (IEC 60134).

Symbol	Parameter	Conditions	Min	Max	Unit
$V_{DS}$	drain-source voltage		-	108	V
$V_{GS}$	gate-source voltage		-6	+11	V
$T_{stg}$	storage temperature		-65	+150	°C
$T_j$	junction temperature	<a href="#">[1]</a>	-	225	°C

[1] Continuous use at maximum temperature will affect the reliability, for details refer to the online MTF calculator.

## 5. Thermal characteristics

**Table 5. Thermal characteristics**

Symbol	Parameter	Conditions	Typ	Unit
$R_{th(j-c)}$	thermal resistance from junction to case	$T_{case} = 90\text{ °C}$ ; $V_{DS} = 50\text{ V}$ ; $I_D = 135\text{ W}$ ; $PAR = 8\text{ dB}$	0.13	K/W

[1] Measured in a broadband application circuit, using DVB-T (8k OFDM) signal; PAR (of output signal) at 0.01 % probability on CCDF; PAR of input signal = 9.5 dB at 0.01 % probability on CCDF.

## 6. Characteristics

**Table 6. DC characteristics**

$T_j = 25\text{ °C}$ ; unless otherwise specified.

Symbol	Parameter	Conditions	Min	Typ	Max	Unit
$V_{(BR)DSS}$	drain-source breakdown voltage	$V_{GS} = 0\text{ V}$ ; $I_D = 2.4\text{ mA}$	108	-	-	V
$V_{GS(th)}$	gate-source threshold voltage	$V_{DS} = 10\text{ V}$ ; $I_D = 240\text{ mA}$	1.5	2.2	2.5	V
$I_{DSS}$	drain leakage current	$V_{GS} = 0\text{ V}$ ; $V_{DS} = 50\text{ V}$	-	-	2.8	$\mu\text{A}$
$I_{DSX}$	drain cut-off current	$V_{GS} = V_{GS(th)} + 3.75\text{ V}$ ; $V_{DS} = 10\text{ V}$	-	41	-	A
$I_{GSS}$	gate leakage current	$V_{GS} = 10\text{ V}$ ; $V_{DS} = 0\text{ V}$	-	-	280	nA
$R_{DS(on)}$	drain-source on-state resistance	$V_{GS} = V_{GS(th)} + 3.75\text{ V}$ ; $I_D = 8.5\text{ A}$	-	90	-	m $\Omega$

**Table 7. AC characteristics**

$T_j = 25\text{ °C}$ ; unless otherwise specified.

Symbol	Parameter	Conditions	Min	Typ	Max	Unit
$C_{iss}$	input capacitance	$V_{GS} = 0\text{ V}$ ; $V_{DS} = 50\text{ V}$ ; $f = 1\text{ MHz}$	-	368	-	pF
$C_{oss}$	output capacitance	$V_{GS} = 0\text{ V}$ ; $V_{DS} = 50\text{ V}$ ; $f = 1\text{ MHz}$	-	69	-	pF
$C_{rss}$	reverse transfer capacitance	$V_{GS} = 0\text{ V}$ ; $V_{DS} = 50\text{ V}$ ; $f = 1\text{ MHz}$	-	0.86	-	pF

**Table 8. RF characteristics**

RF characteristics in Ampleon production test circuit,  $T_{case} = 25\text{ °C}$ ; unless otherwise specified.

Symbol	Parameter	Conditions	Min	Typ	Max	Unit
<b>DVB-T (8k OFDM), class-AB operation</b>						
$V_{DS}$	drain-source voltage		-	50	-	V
$I_{Dq}$	quiescent drain current	per section	-	650	-	mA
$P_{L(AV)}$	average output power	$f = 700\text{ MHz}$	135	-	-	W
$G_p$	power gain	$f = 700\text{ MHz}$	21.5	22.5	-	dB
$\eta_D$	drain efficiency	$f = 700\text{ MHz}$	32	35	-	%
ACPR	adjacent channel power ratio	$f = 700\text{ MHz}$	-	-30	-27	dBc
PAR	peak-to-average ratio	$f = 700\text{ MHz}$	-	8	-	dB

## 7. Test information

### 7.1 Ruggedness in class-AB operation

The BLF989 and BLF989S are capable of withstanding a load mismatch corresponding to  $VSWR \geq 40 : 1$  through all phases under the following conditions:  $V_{DS} = 60 \text{ V}$ ;  $f = 700 \text{ MHz}$ ;  $P_L = 135 \text{ W}$ : DVB-T;  $PAR = 8 \text{ dB}$ .

### 7.2 Test circuit

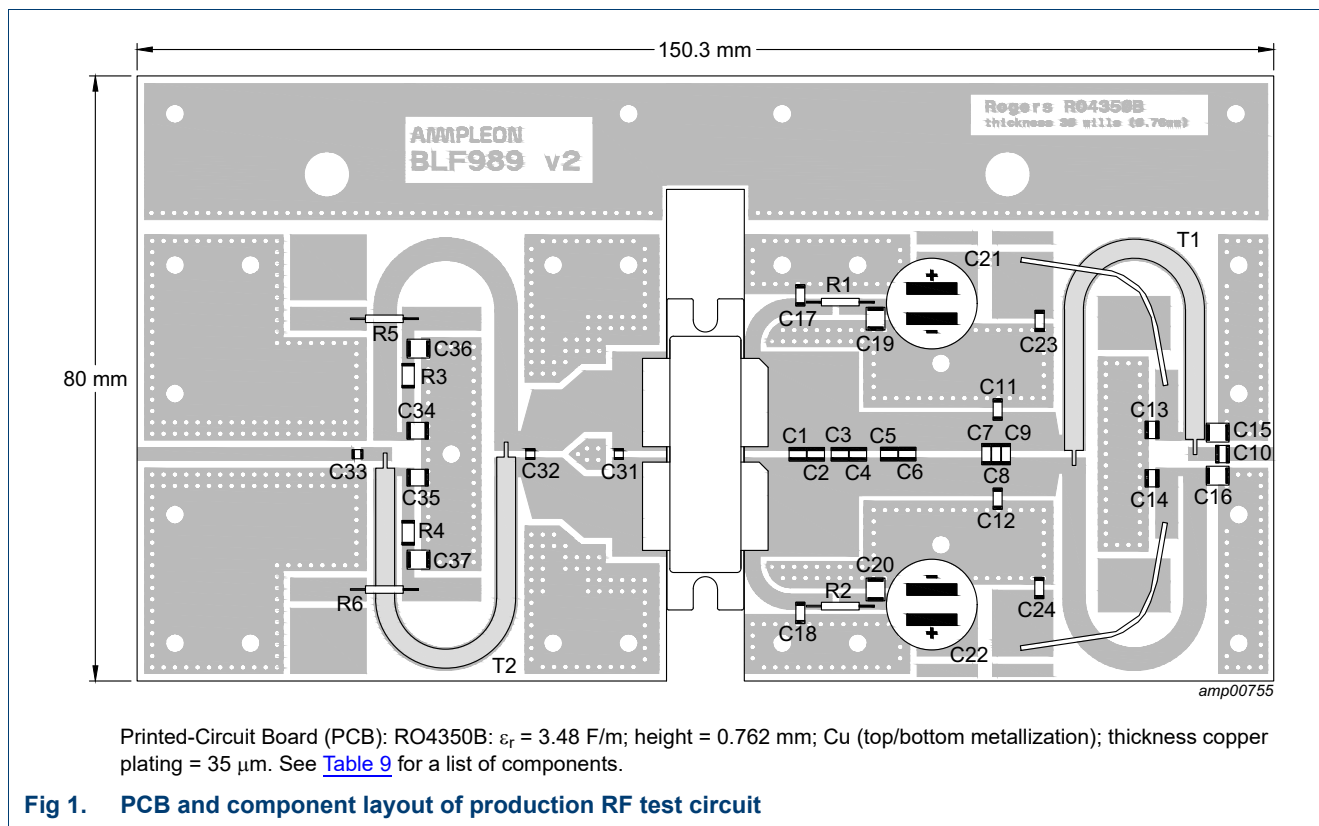

**Table 9. List of components**

See [Figure 1](#) for component layout.

Component	Description	Value	Remarks
C1	multilayer ceramic chip capacitor	12 pF	ATC800R
C2, C3,C4,C5,C6	multilayer ceramic chip capacitor	8.2 pF	ATC800R
C7	multilayer ceramic chip capacitor	6.8 pF	ATC800B
C8	multilayer ceramic chip capacitor	2.7 pF	ATC800B
C9	multilayer ceramic chip capacitor	22 pF	ATC800B
C10, C13, C14	multilayer ceramic chip capacitor	100 pF	ATC180R
C11, C12	multilayer ceramic chip capacitor	10 pF	ATC800B
C15, C16	multilayer ceramic chip capacitor	4.7 $\mu\text{F}$ , 50 V	Kemet: C1210X475K5RAC-TU or similar
C17, C18, C23, C24	multilayer ceramic chip capacitor	100 pF	ATC800B
C19, C20	multilayer ceramic chip capacitor	10 $\mu\text{F}$ , 50 V	TDK: C570X7R1H106KT000N or similar

Table 9. List of components ...continued  
See Figure 1 for component layout.

Component	Description	Value	Remarks
C21, C22	electrolytic capacitor	470 $\mu$ F, 63 V	
C31	multilayer ceramic chip capacitor	18 pF	ATC800A
C32	multilayer ceramic chip capacitor	13 pF	ATC800A
C33, C34, C35	multilayer ceramic chip capacitor	100 pF	ATC100A
C36, C37	multilayer ceramic chip capacitor	4.7 $\mu$ F, 50 V	TDK: C4532X7R1E475MT020U or similar
R1, R2	wire resistor	10 $\Omega$	
R3, R4	SMD resistor	5.6 $\Omega$	
R5, R6	wire resistor	100 $\Omega$	
T1, T2	semi rigid coax	25 $\Omega$ , 60 mm	EZ90-25

### 7.3 Graphical data

#### 7.3.1 Pulsed CW performance measured in class-AB broadband application

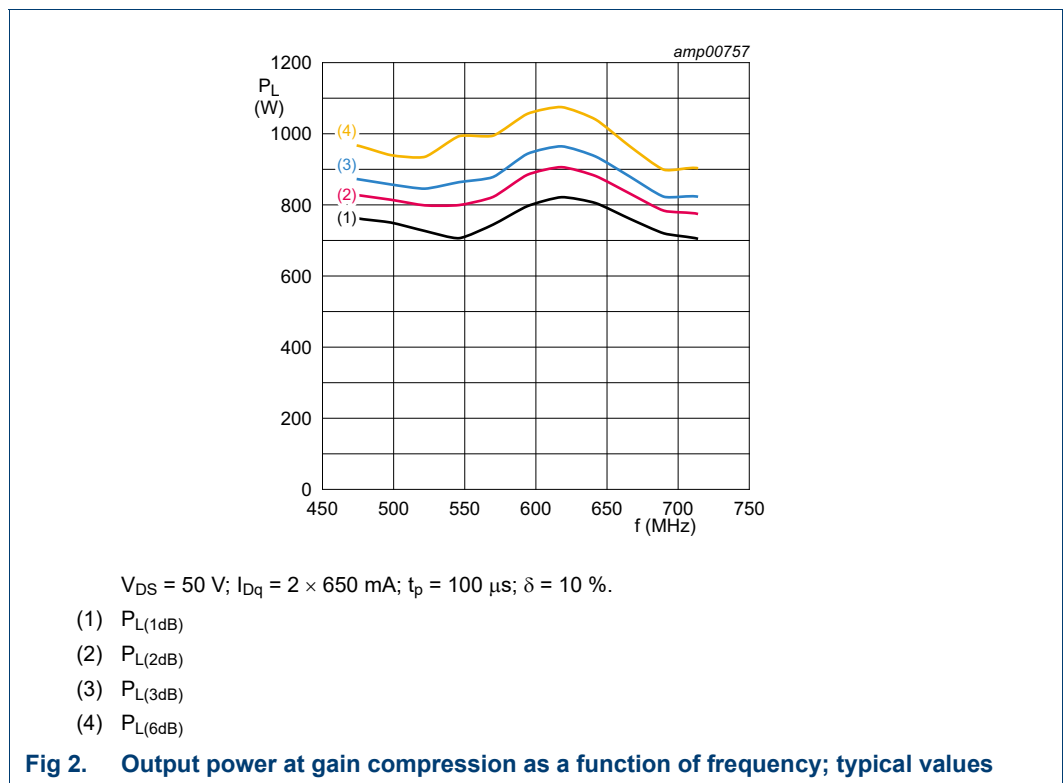

7.3.2 DVB-T performance measured in class-AB broadband application

PAR (of output signal) at 0.01% probability on CCDF; PAR of input signal = 9.5 dB at 0.01% probability on CCDF.

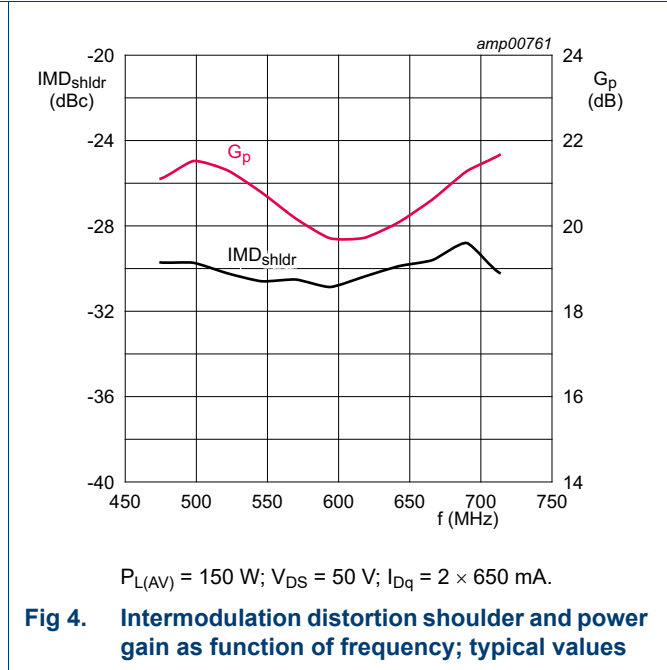
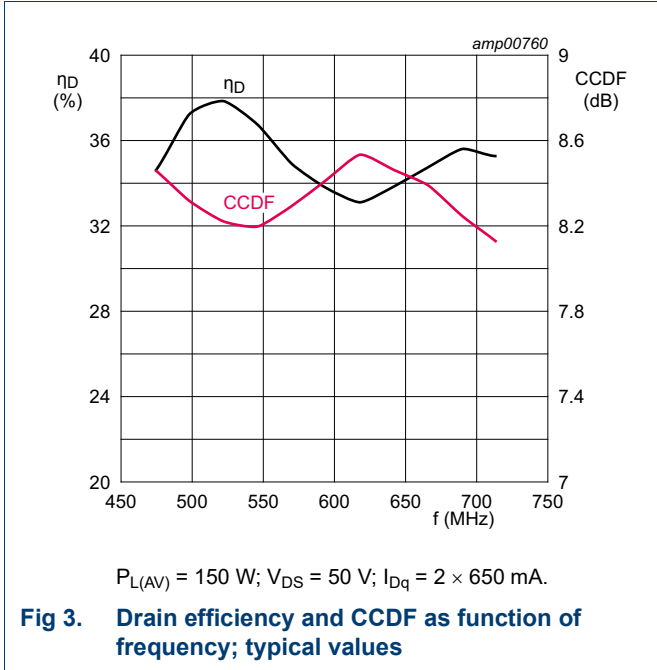

7.3.3 DVB-T performance measured in production RF test circuit

PAR (of output signal) at 0.01% probability on CCDF; PAR of input signal = 9.5 dB at 0.01% probability on CCDF.

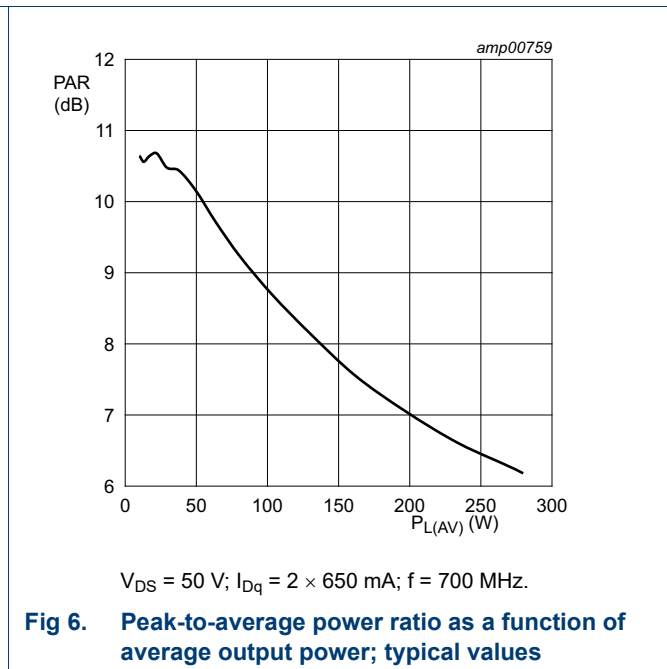
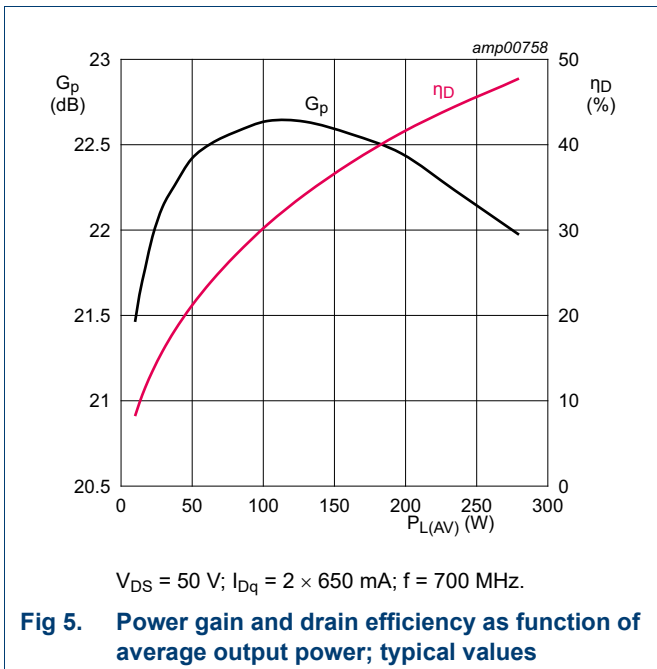

7.3.4 Reliability

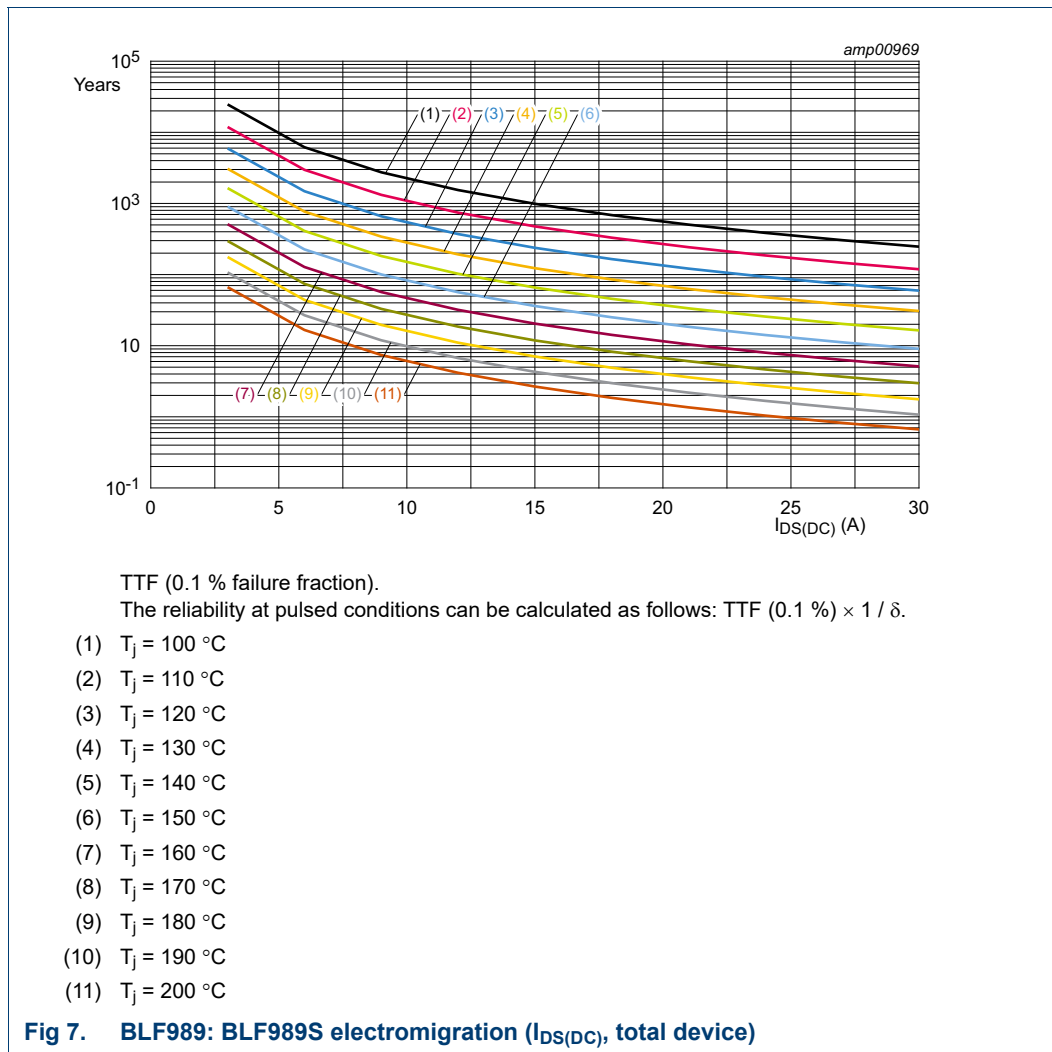

8. Package outline

Flanged balanced ceramic package; 2 mounting holes; 4 leads

SOT539A

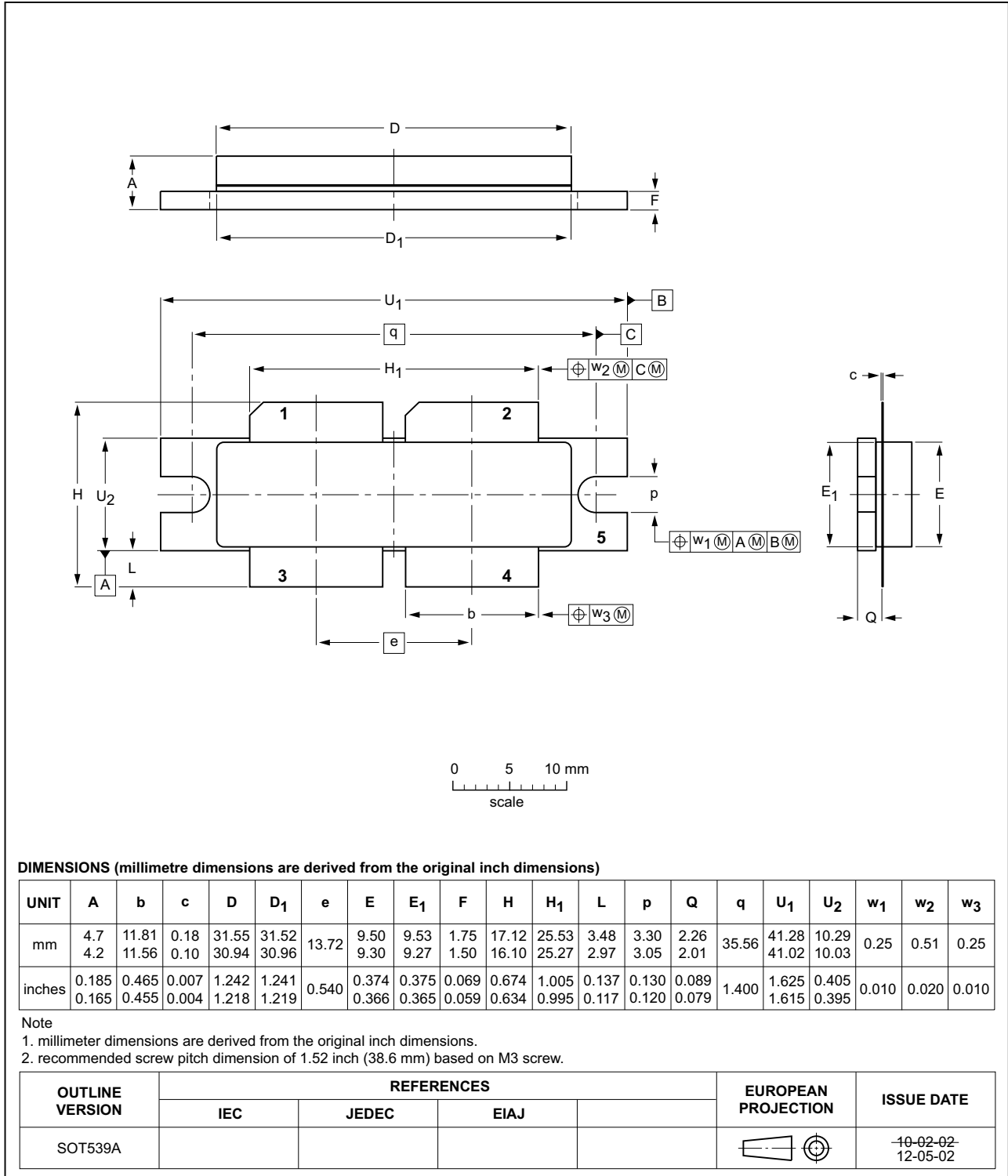

Fig 8. Package outline SOT539A

Earless flanged balanced ceramic package; 4 leads

SOT539B

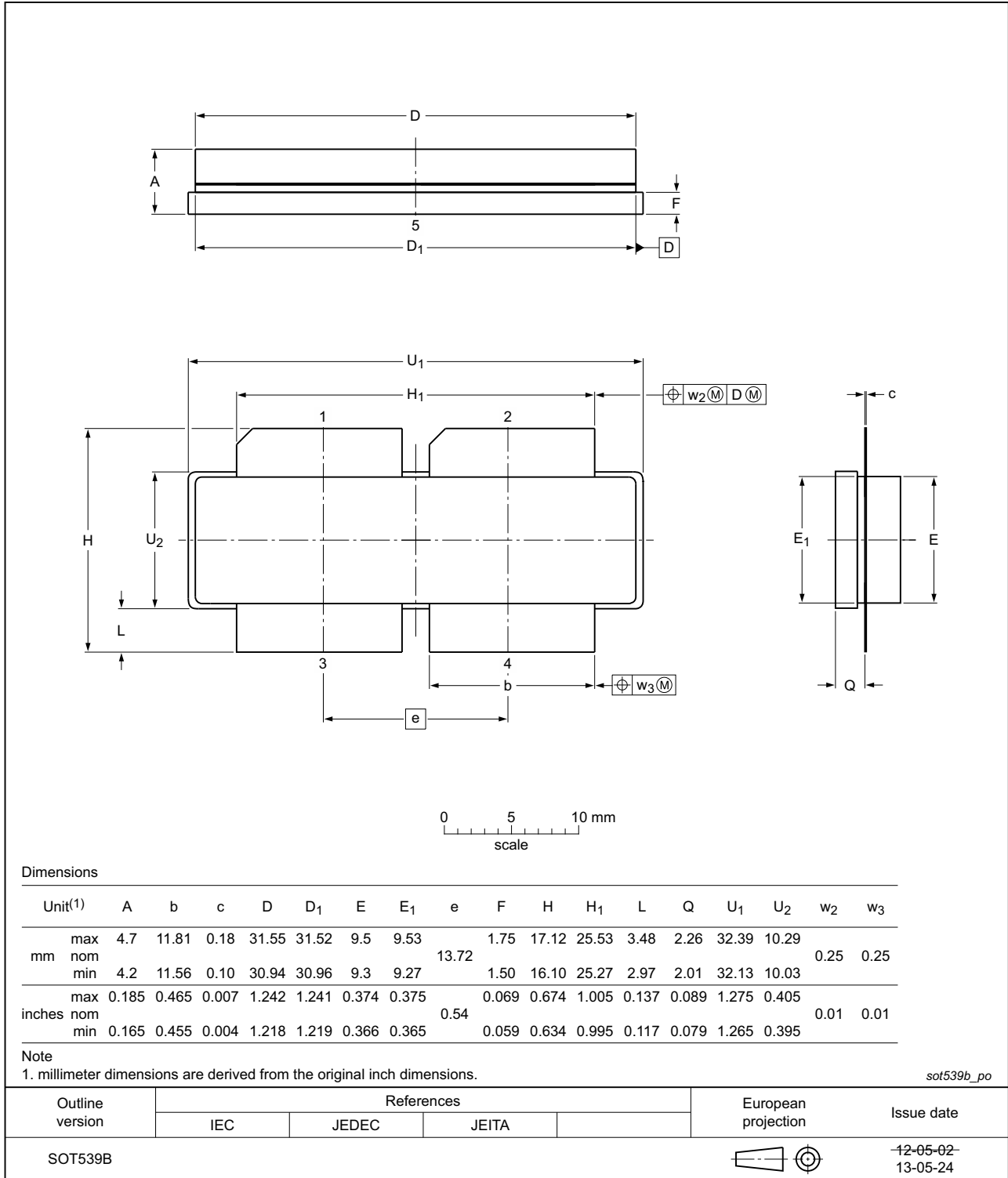

Fig 9. Package outline SOT539B

## 9. Handling information

**CAUTION**



This device is sensitive to ElectroStatic Discharge (ESD). Observe precautions for handling electrostatic sensitive devices.

Such precautions are described in the *ANSI/ESD S20.20*, *IEC/ST 61340-5*, *JESD625-A* or equivalent standards.

**Table 10. ESD sensitivity**

ESD model	Class
Charged Device Model (CDM); According to ANSI/ESDA/JEDEC standard JS-002	C2A <a href="#">[1]</a>
Human Body Model (HBM); According to ANSI/ESDA/JEDEC standard JS-001	2 <a href="#">[2]</a>

[1] CDM classification C2A is granted to any part that passes after exposure to an ESD pulse of 500 V.

[2] HBM classification 2 is granted to any part that passes after exposure to an ESD pulse of 2000 V.

## 10. Abbreviations

**Table 11. Abbreviations**

Acronym	Description
CCDF	Complementary Cumulative Distribution Function
CTTB	China Terrestrial Television Broadcasting
DVB-T	Digital Video Broadcast - Terrestrial
ESD	ElectroStatic Discharge
LDMOS	Laterally Diffused Metal-Oxide Semiconductor
MTF	Median Time to Failure
OFDM	Orthogonal Frequency Division Multiplexing
PAR	Peak-to-Average Ratio
RoHS	Restriction of Hazardous Substances
SMD	Surface Mounted Device
TTF	Time To Failure
UHF	Ultra High Frequency
VSWR	Voltage Standing Wave Ratio

## 11. Revision history

**Table 12. Revision history**

Document ID	Release date	Data sheet status	Change notice	Supersedes
BLF989_BLF989S v.3	20190524	Product data sheet	-	BLF989_BLF989S v.2
Modifications	<ul style="list-style-type: none"> <li><a href="#">Table 1 on page 1</a>: third row added</li> <li><a href="#">Section 7.3.4 on page 7</a>: section added</li> </ul>			
BLF989_BLF989S v.2	20190122	Product data sheet	-	BLF989_BLF989S v.1
BLF989_BLF989S v.1	20180907	Product data sheet	-	-

## 12. Legal information

### 12.1 Data sheet status

Document status <sup>[1][2]</sup>	Product status <sup>[3]</sup>	Definition
Objective [short] data sheet	Development	This document contains data from the objective specification for product development.
Preliminary [short] data sheet	Qualification	This document contains data from the preliminary specification.
Product [short] data sheet	Production	This document contains the product specification.

[1] Please consult the most recently issued document before initiating or completing a design.

[2] The term 'short data sheet' is explained in section "Definitions".

[3] The product status of device(s) described in this document may have changed since this document was published and may differ in case of multiple devices. The latest product status information is available on the Internet at URL <http://www.ampleon.com>.

### 12.2 Definitions

**Draft** — The document is a draft version only. The content is still under internal review and subject to formal approval, which may result in modifications or additions. Ampleon does not give any representations or warranties as to the accuracy or completeness of information included herein and shall have no liability for the consequences of use of such information.

**Short data sheet** — A short data sheet is an extract from a full data sheet with the same product type number(s) and title. A short data sheet is intended for quick reference only and should not be relied upon to contain detailed and full information. For detailed and full information see the relevant full data sheet, which is available on request via the local Ampleon sales office. In case of any inconsistency or conflict with the short data sheet, the full data sheet shall prevail.

**Product specification** — The information and data provided in a Product data sheet shall define the specification of the product as agreed between Ampleon and its customer, unless Ampleon and customer have explicitly agreed otherwise in writing. In no event however, shall an agreement be valid in which the Ampleon product is deemed to offer functions and qualities beyond those described in the Product data sheet.

Ampleon product can reasonably be expected to result in personal injury, death or severe property or environmental damage. Ampleon and its suppliers accept no liability for inclusion and/or use of Ampleon products in such equipment or applications and therefore such inclusion and/or use is at the customer's own risk.

**Applications** — Applications that are described herein for any of these products are for illustrative purposes only. Ampleon makes no representation or warranty that such applications will be suitable for the specified use without further testing or modification.

Customers are responsible for the design and operation of their applications and products using Ampleon products, and Ampleon accepts no liability for any assistance with applications or customer product design. It is customer's sole responsibility to determine whether the Ampleon product is suitable and fit for the customer's applications and products planned, as well as for the planned application and use of customer's third party customer(s). Customers should provide appropriate design and operating safeguards to minimize the risks associated with their applications and products.

Ampleon does not accept any liability related to any default, damage, costs or problem which is based on any weakness or default in the customer's applications or products, or the application or use by customer's third party customer(s). Customer is responsible for doing all necessary testing for the customer's applications and products using Ampleon products in order to avoid a default of the applications and the products or of the application or use by customer's third party customer(s). Ampleon does not accept any liability in this respect.

**Limiting values** — Stress above one or more limiting values (as defined in the Absolute Maximum Ratings System of IEC 60134) will cause permanent damage to the device. Limiting values are stress ratings only and (proper) operation of the device at these or any other conditions above those given in the Recommended operating conditions section (if present) or the Characteristics sections of this document is not warranted. Constant or repeated exposure to limiting values will permanently and irreversibly affect the quality and reliability of the device.

**Terms and conditions of commercial sale** — Ampleon products are sold subject to the general terms and conditions of commercial sale, as published at <http://www.ampleon.com/terms>, unless otherwise agreed in a valid written individual agreement. In case an individual agreement is concluded only the terms and conditions of the respective agreement shall apply. Ampleon hereby expressly objects to applying the customer's general terms and conditions with regard to the purchase of Ampleon products by customer.

**No offer to sell or license** — Nothing in this document may be interpreted or construed as an offer to sell products that is open for acceptance or the grant, conveyance or implication of any license under any copyrights, patents or other industrial or intellectual property rights.

**Export control** — This document as well as the item(s) described herein may be subject to export control regulations. Export might require a prior authorization from competent authorities.

### 12.3 Disclaimers

**Limited warranty and liability** — Information in this document is believed to be accurate and reliable. However, Ampleon does not give any representations or warranties, expressed or implied, as to the accuracy or completeness of such information and shall have no liability for the consequences of use of such information. Ampleon takes no responsibility for the content in this document if provided by an information source outside of Ampleon.

In no event shall Ampleon be liable for any indirect, incidental, punitive, special or consequential damages (including - without limitation - lost profits, lost savings, business interruption, costs related to the removal or replacement of any products or rework charges) whether or not such damages are based on tort (including negligence), warranty, breach of contract or any other legal theory.

Notwithstanding any damages that customer might incur for any reason whatsoever, Ampleon's aggregate and cumulative liability towards customer for the products described herein shall be limited in accordance with the *Terms and conditions of commercial sale* of Ampleon.

**Right to make changes** — Ampleon reserves the right to make changes to information published in this document, including without limitation specifications and product descriptions, at any time and without notice. This document supersedes and replaces all information supplied prior to the publication hereof.

**Suitability for use** — Ampleon products are not designed, authorized or warranted to be suitable for use in life support, life-critical or safety-critical systems or equipment, nor in applications where failure or malfunction of an

**Non-automotive qualified products** — Unless this data sheet expressly states that this specific Ampleon product is automotive qualified, the product is not suitable for automotive use. It is neither qualified nor tested in accordance with automotive testing or application requirements. Ampleon accepts no liability for inclusion and/or use of non-automotive qualified products in automotive equipment or applications.

In the event that customer uses the product for design-in and use in automotive applications to automotive specifications and standards, customer (a) shall use the product without Ampleon's warranty of the product for such automotive applications, use and specifications, and (b) whenever customer uses the product for automotive applications beyond Ampleon's specifications such use shall be solely at customer's own risk, and (c) customer fully indemnifies Ampleon for any liability, damages or failed product claims resulting from customer design and use of the product for automotive applications beyond Ampleon's standard warranty and Ampleon's product specifications.

**Translations** — A non-English (translated) version of a document is for reference only. The English version shall prevail in case of any discrepancy between the translated and English versions.

## 13. Contact information

For more information, please visit: <http://www.ampleon.com>

For sales office addresses, please visit: <http://www.ampleon.com/sales>

## 12.4 Licenses

### ICs with DVB-T or DVB-T2 functionality

Use of this product in any manner that complies with the DVB-T or the DVB-T2 standard may require licenses under applicable patents of the DVB-T respectively the DVB-T2 patent portfolio, which license is available from Sisvel S.p.A., Via Sestriere 100, 10060 None (TO), Italy, and under applicable patents of other parties.

## 12.5 Trademarks

Notice: All referenced brands, product names, service names and trademarks are the property of their respective owners.

Any reference or use of any 'NXP' trademark in this document or in or on the surface of Ampleon products does not result in any claim, liability or entitlement vis-à-vis the owner of this trademark. Ampleon is no longer part of the NXP group of companies and any reference to or use of the 'NXP' trademarks will be replaced by reference to or use of Ampleon's own trademarks.

14. Contents

1 **Product profile** . . . . . 1

1.1 General description . . . . . 1

1.2 Features and benefits . . . . . 1

1.3 Applications . . . . . 1

2 **Pinning information** . . . . . 2

3 **Ordering information** . . . . . 2

4 **Limiting values** . . . . . 2

5 **Thermal characteristics** . . . . . 3

6 **Characteristics** . . . . . 3

7 **Test information** . . . . . 4

7.1 Ruggedness in class-AB operation . . . . . 4

7.2 Test circuit . . . . . 4

7.3 Graphical data . . . . . 5

7.3.1 Pulsed CW performance measured in class-AB broadband application . . . . . 5

7.3.2 DVB-T performance measured in class-AB broadband application . . . . . 6

7.3.3 DVB-T performance measured in production RF test circuit . . . . . 6

7.3.4 Reliability . . . . . 7

8 **Package outline** . . . . . 8

9 **Handling information** . . . . . 10

10 **Abbreviations** . . . . . 10

11 **Revision history** . . . . . 10

12 **Legal information** . . . . . 11

12.1 Data sheet status . . . . . 11

12.2 Definitions . . . . . 11

12.3 Disclaimers . . . . . 11

12.4 Licenses . . . . . 12

12.5 Trademarks . . . . . 12

13 **Contact information** . . . . . 12

14 **Contents** . . . . . 13

Please be aware that important notices concerning this document and the product(s) described herein, have been included in section 'Legal information'.

© Ampleon Netherlands B.V. 2019. All rights reserved.



For more information, please visit: <http://www.ampleon.com>  
 For sales office addresses, please visit: <http://www.ampleon.com/sales>

Date of release: 24 May 2019

Document identifier: BLF989\_BLF989S

## Looking for pricing, stock, or lifecycle information?

Click below to explore more details on WIN SOURCE:

-  [View BLF989U on WIN SOURCE](#)
-  [Ampleon USA Inc. Information](#)

## Optimize Your Supply Chain with WIN SOURCE Solutions

-  Global Sourcing Solution
-  Obsolete Management
-  Cost Control Management
-  Shortage Management
-  Alternative Solution
-  Excess Inventory Management