



**THE DATASHEET OF  
CBC2012T2R2MV**



## Notice for TAIYO YUDEN Products

[ For High Quality and/or Reliability Equipment  
(Automotive Electronic Equipment / Industrial Equipment) ]

Please read this notice before using the TAIYO YUDEN products.

### REMINDERS

- Product information in this catalog is as of October 2018. All of the contents specified herein are subject to change without notice due to technical improvements, etc. Therefore, please check for the latest information carefully before practical application or use of our products.

Please note that TAIYO YUDEN shall not be in any way responsible for any damages and defects in products or equipment incorporating our products, which are caused under the conditions other than those specified in this catalog or individual product specification sheets.

- Please contact TAIYO YUDEN for further details of product specifications as the individual product specification sheets are available.
- Please conduct validation and verification of our products in actual condition of mounting and operating environment before using our products.
- The products listed in this catalog are intended for use in general electronic equipment (e.g., AV equipment, OA equipment, home electric appliances, office equipment, information and communication equipment), medical equipment classified as Class I or II by IMDRF, industrial equipment, and automotive interior applications, etc. Please be sure to contact TAIYO YUDEN for further information before using the products for any equipment which may directly cause loss of human life or bodily injury (e.g., transportation equipment including, without limitation, automotive powertrain control system, train control system, and ship control system, traffic signal equipment, medical equipment classified as Class III by IMDRF).

Please do not incorporate our products into any equipment requiring high levels of safety and/or reliability (e.g., aerospace equipment, aviation equipment\*, medical equipment classified as Class IV by IMDRF, nuclear control equipment, undersea equipment, military equipment).

\*Note: There is a possibility that our products can be used only for aviation equipment that does not directly affect the safe operation of aircraft (e.g., in-flight entertainment, cabin light, electric seat, cooking equipment) if such use meets requirements specified separately by TAIYO YUDEN. Please be sure to contact TAIYO YUDEN for further information before using our products for such aviation equipment.

When our products are used even for high safety and/or reliability-required devices or circuits of general electronic equipment, it is strongly recommended to perform a thorough safety evaluation prior to use of our products and to install a protection circuit as necessary.

Please note that unless you obtain prior written consent of TAIYO YUDEN, TAIYO YUDEN shall not be in any way responsible for any damages incurred by you or third parties arising from use of the products listed in this catalog for any equipment requiring inquiry to TAIYO YUDEN or prohibited for use by TAIYO YUDEN as described above.

- Information contained in this catalog is intended to convey examples of typical performances and/or applications of our products and is not intended to make any warranty with respect to the intellectual property rights or any other related rights of TAIYO YUDEN or any third parties nor grant any license under such rights.
- Please note that the scope of warranty for our products is limited to the delivered our products themselves and TAIYO YUDEN shall not be in any way responsible for any damages resulting from a fault or defect in our products. Notwithstanding the foregoing, if there is a written agreement (e.g., supply and purchase agreement, quality assurance agreement) signed by TAIYO YUDEN and your company, TAIYO YUDEN will warrant our products in accordance with such agreement.
- The contents of this catalog are applicable to our products which are purchased from our sales offices or authorized distributors (hereinafter "TAIYO YUDEN's official sales channel"). Please note that the contents of this catalog are not applicable to our products purchased from any seller other than TAIYO YUDEN's official sales channel.

#### ■ Caution for Export

Some of our products listed in this catalog may require specific procedures for export according to "U.S. Export Administration Regulations", "Foreign Exchange and Foreign Trade Control Law" of Japan, and other applicable regulations. Should you have any questions on this matter, please contact our sales staff.

# Automotive Application Guide

We classify automotive electronic equipment into the following four application categories and set usable application categories for each of our products. When using our products for automotive electronic equipment, please be sure to check such application categories and use our products accordingly. Should you have any questions on this matter, please contact us.

| Category       | Automotive Electronic Equipment (Typical Example)   |
|----------------|---|
| POWERTRAIN     | <ul style="list-style-type: none"> <li>• Engine ECU (Electronically Controlled Fuel Injector)</li> <li>• Cruise Control Unit</li> <li>• 4WS (4 Wheel Steering)</li> <li>• Automatic Transmission</li> <li>• Power Steering</li> <li>• HEV/PHV/EV Core Control (Battery, Inverter, DC-DC)</li> <li>• Automotive Locator (Car location information providing device), etc.</li> </ul> |
| SAFETY         | <ul style="list-style-type: none"> <li>• ABS (Anti-Lock Brake System)</li> <li>• ESC (Electronic Stability Control)</li> <li>• Airbag</li> <li>• ADAS (Equipment that directly controls running, turning and stopping), etc.</li> </ul>   |
| BODY & CHASSIS | <ul style="list-style-type: none"> <li>• Wiper</li> <li>• Automatic Door</li> <li>• Power Window</li> <li>• Keyless Entry System</li> <li>• Electric Door Mirror</li> <li>• Interior Lighting</li> <li>• LED Headlight</li> <li>• TPMS (Tire Pressure Monitoring System)</li> <li>• Anti-Theft Device (Immobilizer), etc.</li> </ul>  |
| INFOTAINMENT   | <ul style="list-style-type: none"> <li>• Car Infotainment System</li> <li>• ITS/Telematics System</li> <li>• Instrument Cluster</li> <li>• ADAS (Sensor, Equipment that is not interlocked with safety equipment or powertrain), etc.</li> </ul>  |

# WIRE-WOUND CHIP POWER INDUCTORS(CB SERIES)

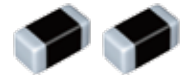

REFLOW

■ PART NUMBER

\*Operating Temp. : -40~105°C (Including self-generated heat)

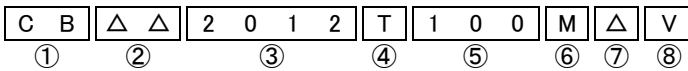

△=Blank space

①Series name

| Code | Series name               |
|------|---------------------------|
| CB   | Wound chip power inductor |

②Characteristics

| Code | Characteristics |
|------|-----------------|
| △△   | Standard        |
| △C   | High current    |

③Dimensions (L × W)

| Code | Type (inch) | Dimensions (L × W) [mm] |
|------|-------------|-------------------------|
| 2012 | 2012(0805)  | 2.0 × 1.25              |
| 2016 | 2016(0806)  | 2.0 × 1.6               |
| 2518 | 2518(1007)  | 2.5 × 1.8               |
| 3225 | 3225(1210)  | 3.2 × 2.5               |

④Packaging

| Code | Packaging |
|------|-----------|
| T    | Taping    |

⑤Nominal inductance

| Code (example) | Nominal inductance [μH] |
|----------------|-------------------------|
| 1R0            | 1.0                     |
| 100            | 10                      |
| 101            | 100                     |

※R=Decimal point

⑥Inductance tolerance

| Code | Inductance tolerance |
|------|----------------------|
| K    | ±10%                 |
| M    | ±20%                 |

⑦Special code

| Code | Special code |
|------|--------------|
| △    | Standard     |
| R    | Low Rdc type |

⑧Internal code

| Code | Internal code                          |
|------|--|
| V    | Inductor for Industrial and Automotive |

■ STANDARD EXTERNAL DIMENSIONS / STANDARD QUANTITY

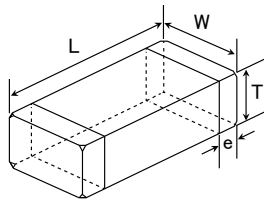

Recommended Land Patterns

Surface Mounting

- Mounting and soldering conditions should be checked beforehand.
- Applicable soldering process to these products is reflow soldering only.

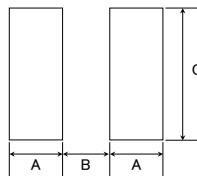

| Type | A    | B   | C    |
|------|------|-----|------|
| 2012 | 0.60 | 1.0 | 1.45 |
| 2016 | 0.60 | 1.0 | 1.8  |
| 2518 | 0.60 | 1.5 | 2.0  |
| 3225 | 0.85 | 1.7 | 2.7  |

Unit : mm

| Type     | L             | W             | T             | e             | Standard quantity [pcs] |               |
|----------|---------------|---------------|---------------|---------------|-------------------------|---------------|
|          |               |               |               |               | Paper tape              | Embossed tape |
| CB 2012  | 2.0±0.2       | 1.25±0.2      | 1.25±0.2      | 0.5±0.2       | —                       | 3000          |
| CB C2012 | (0.079±0.008) | (0.049±0.008) | (0.049±0.008) | (0.020±0.008) |                         |               |
| CB 2016  | 2.0±0.2       | 1.6±0.2       | 1.6±0.2       | 0.5±0.2       | —                       | 2000          |
| CB C2016 | (0.079±0.008) | (0.063±0.008) | (0.063±0.008) | (0.020±0.008) |                         |               |
| CB 2518  | 2.5±0.2       | 1.8±0.2       | 1.8±0.2       | 0.5±0.2       | —                       | 2000          |
| CB C2518 | (0.098±0.008) | (0.071±0.008) | (0.071±0.008) | (0.020±0.008) |                         |               |
| CB C3225 | 3.2±0.2       | 2.5±0.2       | 2.5±0.2       | 0.6±0.3       | —                       | 1000          |
|          | (0.126±0.008) | (0.098±0.008) | (0.098±0.008) | (0.024±0.012) |                         |               |

Unit : mm (inch)

▶ This catalog contains the typical specification only due to the limitation of space. When you consider the purchase of our products, please check our product specification sheets. For details of each product (characteristics graph, reliability information, precautions for use, and so on), see our website (<http://www.ty-top.com/>).

■ PART NUMBER

• All the Wire-wound Chip Power Inductors of the catalog lineup are RoHS compliant.

Note)

- The exchange of individual specifications is necessary depending on the application and circuit condition. Please contact Taiyo Yuden sales channels.
- \*2: Industrial products and Medical products

Please consult with TAIYO YUDEN's official sales channel for the details of the product specification, etc., and please review and approve TAIYO YUDEN's product specification before ordering.

Please be sure to contact us for further information before using the products for automotive electronic equipment.

● 2012 (0805) type

| Part number    | Nominal inductance [μH] | Inductance tolerance | Self-resonant frequency [MHz] (min.) | DC Resistance [Ω] (±30%) | Rated current ※) [mA]   |                               | Measuring frequency [MHz] | Note |
|----------------|-------------------------|----------------------|--------------------------------------|--------------------------|-------------------------|-------------------------------|---------------------------|------|
|                |                         |                      |                                      |                          | Saturation current Idc1 | Temperature rise current Idc2 |                           |      |
| CB 2012T1R0M V | 1.0                     | ±20%                 | 100                                  | 0.15                     | 500                     | 700                           | 7.96                      | *2   |
| CB 2012T2R2M V | 2.2                     | ±20%                 | 80                                   | 0.23                     | 410                     | 620                           | 7.96                      | *2   |
| CB 2012T3R3M V | 3.3                     | ±20%                 | 55                                   | 0.30                     | 330                     | 550                           | 7.96                      | *2   |
| CB 2012T4R7M V | 4.7                     | ±20%                 | 45                                   | 0.40                     | 300                     | 430                           | 7.96                      | *2   |
| CB 2012T6R8M V | 6.8                     | ±20%                 | 38                                   | 0.47                     | 250                     | 350                           | 7.96                      | *2   |
| CB 2012T100□ V | 10                      | ±10%, ±20%           | 32                                   | 0.70                     | 190                     | 300                           | 2.52                      | *2   |
| CB 2012T100□RV | 10                      | ±10%, ±20%           | 32                                   | 0.50                     | 200                     | 300                           | 2.52                      | *2   |
| CB 2012T150□ V | 15                      | ±10%, ±20%           | 28                                   | 1.3                      | 170                     | 240                           | 2.52                      | *2   |
| CB 2012T220□ V | 22                      | ±10%, ±20%           | 16                                   | 1.7                      | 135                     | 220                           | 2.52                      | *2   |
| CB 2012T470□ V | 47                      | ±10%, ±20%           | 11                                   | 3.7                      | 90                      | 140                           | 2.52                      | *2   |
| CB 2012T680□ V | 68                      | ±10%, ±20%           | 10                                   | 6.0                      | 70                      | 100                           | 2.52                      | *2   |
| CB 2012T101□ V | 100                     | ±10%, ±20%           | 8                                    | 7.0                      | 60                      | 100                           | 0.796                     | *2   |

| Part number     | Nominal inductance [μH] | Inductance tolerance | Self-resonant frequency [MHz] (min.) | DC Resistance [Ω] (±30%) | Rated current ※) [mA]   |                               | Measuring frequency [MHz] | Note |
|-----------------|-------------------------|----------------------|--------------------------------------|--------------------------|-------------------------|-------------------------------|---------------------------|------|
|                 |                         |                      |                                      |                          | Saturation current Idc1 | Temperature rise current Idc2 |                           |      |
| CB C2012T1R0M V | 1.0                     | ±20%                 | 100                                  | 0.19                     | 700                     | 640                           | 7.96                      | *2   |
| CB C2012T2R2M V | 2.2                     | ±20%                 | 70                                   | 0.33                     | 530                     | 485                           | 7.96                      | *2   |
| CB C2012T4R7M V | 4.7                     | ±20%                 | 45                                   | 0.50                     | 360                     | 395                           | 7.96                      | *2   |
| CB C2012T100□ V | 10                      | ±10%, ±20%           | 40                                   | 1.2                      | 240                     | 255                           | 2.52                      | *2   |
| CB C2012T220□ V | 22                      | ±10%, ±20%           | 16                                   | 3.7                      | 170                     | 145                           | 2.52                      | *2   |
| CB C2012T470□ V | 47                      | ±10%, ±20%           | 11                                   | 5.8                      | 120                     | 115                           | 2.52                      | *2   |

● 2016 (0806) type

| Part number    | Nominal inductance [μH] | Inductance tolerance | Self-resonant frequency [MHz] (min.) | DC Resistance [Ω] (±30%) | Rated current ※) [mA]   |                               | Measuring frequency [MHz] | Note |
|----------------|-------------------------|----------------------|--------------------------------------|--------------------------|-------------------------|-------------------------------|---------------------------|------|
|                |                         |                      |                                      |                          | Saturation current Idc1 | Temperature rise current Idc2 |                           |      |
| CB 2016T1R0M V | 1.0                     | ±20%                 | 100                                  | 0.09                     | 600                     | 720                           | 7.96                      | *2   |
| CB 2016T1R5M V | 1.5                     | ±20%                 | 80                                   | 0.11                     | 550                     | 650                           | 7.96                      | *2   |
| CB 2016T2R2M V | 2.2                     | ±20%                 | 70                                   | 0.13                     | 510                     | 600                           | 7.96                      | *2   |
| CB 2016T3R3M V | 3.3                     | ±20%                 | 55                                   | 0.20                     | 400                     | 440                           | 7.96                      | *2   |
| CB 2016T4R7M V | 4.7                     | ±20%                 | 45                                   | 0.25                     | 340                     | 410                           | 7.96                      | *2   |
| CB 2016T6R8M V | 6.8                     | ±20%                 | 38                                   | 0.35                     | 300                     | 330                           | 7.96                      | *2   |
| CB 2016T100□ V | 10                      | ±10%, ±20%           | 32                                   | 0.50                     | 250                     | 270                           | 2.52                      | *2   |
| CB 2016T150□ V | 15                      | ±10%, ±20%           | 28                                   | 0.70                     | 210                     | 220                           | 2.52                      | *2   |
| CB 2016T220□ V | 22                      | ±10%, ±20%           | 16                                   | 1.0                      | 165                     | 190                           | 2.52                      | *2   |
| CB 2016T330□ V | 33                      | ±10%, ±20%           | 14                                   | 1.7                      | 130                     | 140                           | 2.52                      | *2   |
| CB 2016T470□ V | 47                      | ±10%, ±20%           | 11                                   | 2.4                      | 110                     | 120                           | 2.52                      | *2   |
| CB 2016T680□ V | 68                      | ±10%, ±20%           | 10                                   | 3.0                      | 90                      | 110                           | 2.52                      | *2   |
| CB 2016T101□ V | 100                     | ±10%, ±20%           | 8                                    | 4.5                      | 70                      | 90                            | 0.796                     | *2   |

| Part number     | Nominal inductance [μH] | Inductance tolerance | Self-resonant frequency [MHz] (min.) | DC Resistance [Ω] (±30%) | Rated current ※) [mA]   |                               | Measuring frequency [MHz] | Note |
|-----------------|-------------------------|----------------------|--------------------------------------|--------------------------|-------------------------|-------------------------------|---------------------------|------|
|                 |                         |                      |                                      |                          | Saturation current Idc1 | Temperature rise current Idc2 |                           |      |
| CB C2016T1R0M V | 1.0                     | ±20%                 | 100                                  | 0.10                     | 1,100                   | 885                           | 7.96                      | *2   |
| CB C2016T1R5M V | 1.5                     | ±20%                 | 80                                   | 0.15                     | 1,000                   | 775                           | 7.96                      | *2   |
| CB C2016T2R2M V | 2.2                     | ±20%                 | 70                                   | 0.20                     | 750                     | 625                           | 7.96                      | *2   |
| CB C2016T3R3M V | 3.3                     | ±20%                 | 55                                   | 0.27                     | 600                     | 535                           | 7.96                      | *2   |
| CB C2016T4R7M V | 4.7                     | ±20%                 | 45                                   | 0.37                     | 550                     | 460                           | 7.96                      | *2   |
| CB C2016T6R8M V | 6.8                     | ±20%                 | 38                                   | 0.59                     | 450                     | 360                           | 7.96                      | *2   |
| CB C2016T100□ V | 10                      | ±10%, ±20%           | 32                                   | 0.82                     | 380                     | 305                           | 2.52                      | *2   |
| CB C2016T150□ V | 15                      | ±10%, ±20%           | 28                                   | 1.2                      | 300                     | 255                           | 2.52                      | *2   |
| CB C2016T220□ V | 22                      | ±10%, ±20%           | 16                                   | 1.8                      | 250                     | 205                           | 2.52                      | *2   |
| CB C2016T330□ V | 33                      | ±10%, ±20%           | 14                                   | 2.8                      | 220                     | 165                           | 2.52                      | *2   |
| CB C2016T470□ V | 47                      | ±10%, ±20%           | 11                                   | 4.3                      | 150                     | 130                           | 2.52                      | *2   |
| CB C2016T680□ V | 68                      | ±10%, ±20%           | 10                                   | 7.0                      | 130                     | 105                           | 2.52                      | *2   |
| CB C2016T101□ V | 100                     | ±10%, ±20%           | 8                                    | 8.0                      | 110                     | 95                            | 0.796                     | *2   |

□ Please specify the Inductance tolerance code (Kor M)

※) The saturation current value (Idc1) is the DC current value having inductance decrease down to 30%. (at 20°C)  
 ※) The temperature rise current value (Idc2) is the DC current value having temperature increase by 20°C. (at 20°C)  
 ※) The rated current value is following either Idc1 or Idc2, which is the lower one.

▶ This catalog contains the typical specification only due to the limitation of space. When you consider the purchase of our products, please check our product specification sheets. For details of each product (characteristics graph, reliability information, precautions for use, and so on), see our website (<http://www.ty-top.com/>).

## PART NUMBER

## ● 2518 (1007) type

| Part number    | Nominal inductance<br>[ $\mu$ H] | Inductance tolerance    | Self-resonant<br>frequency<br>[MHz] (min.) | DC Resistance<br>[ $\Omega$ ] ( $\pm 30\%$ ) | Rated current ※) [mA]      |                                  | Measuring<br>frequency [MHz] | Note |
|----------------|----------------------------------|-------------------------|--|--|----------------------------|----------------------------------|------------------------------|------|
|                |                                  |                         |  |  | Saturation current<br>Idc1 | Temperature rise current<br>Idc2 |                              |      |
| CB 2518T1R0M V | 1.0                              | $\pm 20\%$              | 100  | 0.06   | 1,200                      | 1,250                            | 7.96                         | *2   |
| CB 2518T1R5M V | 1.5                              | $\pm 20\%$              | 80   | 0.07   | 650                        | 1,100                            | 7.96                         | *2   |
| CB 2518T2R2M V | 2.2                              | $\pm 20\%$              | 68   | 0.09   | 510                        | 1,000                            | 7.96                         | *2   |
| CB 2518T3R3M V | 3.3                              | $\pm 20\%$              | 54   | 0.11   | 440                        | 900                              | 7.96                         | *2   |
| CB 2518T4R7MRV | 4.7                              | $\pm 20\%$              | 46   | 0.10   | 310                        | 820                              | 7.96                         | *2   |
| CB 2518T4R7M V | 4.7                              | $\pm 20\%$              | 46   | 0.13   | 340                        | 820                              | 7.96                         | *2   |
| CB 2518T6R8M V | 6.8                              | $\pm 20\%$              | 38   | 0.15   | 270                        | 750                              | 7.96                         | *2   |
| CB 2518T100□ V | 10                               | $\pm 10\%$ , $\pm 20\%$ | 30   | 0.25   | 250                        | 600                              | 2.52                         | *2   |
| CB 2518T150□ V | 15                               | $\pm 10\%$ , $\pm 20\%$ | 23   | 0.32   | 180                        | 500                              | 2.52                         | *2   |
| CB 2518T220□ V | 22                               | $\pm 10\%$ , $\pm 20\%$ | 19   | 0.50   | 165                        | 390                              | 2.52                         | *2   |
| CB 2518T330□ V | 33                               | $\pm 10\%$ , $\pm 20\%$ | 15   | 0.70   | 130                        | 320                              | 2.52                         | *2   |
| CB 2518T470□ V | 47                               | $\pm 10\%$ , $\pm 20\%$ | 12   | 0.95   | 110                        | 270                              | 2.52                         | *2   |
| CB 2518T680□ V | 68                               | $\pm 10\%$ , $\pm 20\%$ | 9.5  | 1.5  | 70                         | 210                              | 2.52                         | *2   |
| CB 2518T101□ V | 100                              | $\pm 10\%$ , $\pm 20\%$ | 9.0  | 2.1  | 60                         | 190                              | 0.796                        | *2   |
| CB 2518T151□ V | 150                              | $\pm 10\%$ , $\pm 20\%$ | 7.0  | 3.2  | 55                         | 140                              | 0.796                        | *2   |
| CB 2518T221□ V | 220                              | $\pm 10\%$ , $\pm 20\%$ | 5.5  | 4.5  | 50                         | 110                              | 0.796                        | *2   |
| CB 2518T331□ V | 330                              | $\pm 10\%$ , $\pm 20\%$ | 4.5  | 7.0  | 40                         | 90                               | 0.796                        | *2   |
| CB 2518T471□ V | 470                              | $\pm 10\%$ , $\pm 20\%$ | 3.5  | 10   | 35                         | 70                               | 0.796                        | *2   |
| CB 2518T681□ V | 680                              | $\pm 10\%$ , $\pm 20\%$ | 3.0  | 17   | 30                         | 50                               | 0.796                        | *2   |
| CB 2518T102□ V | 1000                             | $\pm 10\%$ , $\pm 20\%$ | 2.4  | 24   | 25                         | 45                               | 0.252                        | *2   |

| Part number     | Nominal inductance<br>[ $\mu$ H] | Inductance tolerance    | Self-resonant<br>frequency<br>[MHz] (min.) | DC Resistance<br>[ $\Omega$ ] ( $\pm 30\%$ ) | Rated current ※) [mA]      |                                  | Measuring<br>frequency [MHz] | Note |
|-----------------|----------------------------------|-------------------------|--|--|----------------------------|----------------------------------|------------------------------|------|
|                 |                                  |                         |  |  | Saturation current<br>Idc1 | Temperature rise current<br>Idc2 |                              |      |
| CB C2518T1R0M V | 1.0                              | $\pm 20\%$              | 100  | 0.08   | 1,000                      | 775                              | 7.96                         | *2   |
| CB C2518T1R5M V | 1.5                              | $\pm 20\%$              | 80   | 0.11   | 950                        | 730                              | 7.96                         | *2   |
| CB C2518T2R2M V | 2.2                              | $\pm 20\%$              | 68   | 0.13   | 890                        | 630                              | 7.96                         | *2   |
| CB C2518T3R3M V | 3.3                              | $\pm 20\%$              | 54   | 0.16   | 730                        | 560                              | 7.96                         | *2   |
| CB C2518T4R7M V | 4.7                              | $\pm 20\%$              | 41   | 0.20   | 680                        | 510                              | 7.96                         | *2   |
| CB C2518T6R8M V | 6.8                              | $\pm 20\%$              | 38   | 0.30   | 550                        | 420                              | 7.96                         | *2   |
| CB C2518T100□ V | 10                               | $\pm 10\%$ , $\pm 20\%$ | 30   | 0.36   | 480                        | 375                              | 2.52                         | *2   |
| CB C2518T150□ V | 15                               | $\pm 10\%$ , $\pm 20\%$ | 23   | 0.65   | 350                        | 285                              | 2.52                         | *2   |
| CB C2518T220□ V | 22                               | $\pm 10\%$ , $\pm 20\%$ | 19   | 0.77   | 320                        | 250                              | 2.52                         | *2   |
| CB C2518T330□ V | 33                               | $\pm 10\%$ , $\pm 20\%$ | 15   | 1.5  | 270                        | 185                              | 2.52                         | *2   |
| CB C2518T470□ V | 47                               | $\pm 10\%$ , $\pm 20\%$ | 12   | 1.9  | 240                        | 165                              | 2.52                         | *2   |
| CB C2518T680□ V | 68                               | $\pm 10\%$ , $\pm 20\%$ | 9.5  | 2.8  | 200                        | 140                              | 2.52                         | *2   |
| CB C2518T101□ V | 100                              | $\pm 10\%$ , $\pm 20\%$ | 9.0  | 3.7  | 160                        | 125                              | 0.796                        | *2   |
| CB C2518T151□ V | 150                              | $\pm 10\%$ , $\pm 20\%$ | 7.0  | 6.1  | 140                        | 95                               | 0.796                        | *2   |
| CB C2518T221□ V | 220                              | $\pm 10\%$ , $\pm 20\%$ | 5.5  | 8.4  | 115                        | 80                               | 0.796                        | *2   |
| CB C2518T331□ V | 330                              | $\pm 10\%$ , $\pm 20\%$ | 4.5  | 12.3   | 100                        | 65                               | 0.796                        | *2   |
| CB C2518T471□ V | 470                              | $\pm 10\%$ , $\pm 20\%$ | 3.5  | 22   | 80                         | 50                               | 0.796                        | *2   |
| CB C2518T681□ V | 680                              | $\pm 10\%$ , $\pm 20\%$ | 3.0  | 28   | 65                         | 45                               | 0.796                        | *2   |

## ● 3225 (1210) type

| Part number     | Nominal inductance<br>[ $\mu$ H] | Inductance tolerance    | Self-resonant<br>frequency<br>[MHz] (min.) | DC Resistance<br>[ $\Omega$ ] ( $\pm 30\%$ ) | Rated current ※) [mA]      |                                  | Measuring<br>frequency [MHz] | Note |
|-----------------|----------------------------------|-------------------------|--|--|----------------------------|----------------------------------|------------------------------|------|
|                 |                                  |                         |  |  | Saturation current<br>Idc1 | Temperature rise current<br>Idc2 |                              |      |
| CB C3225T1R0MRV | 1.0                              | $\pm 20\%$              | 250  | 0.055  | 2,000                      | 1,100                            | 0.1                          | *2   |
| CB C3225T1R5MRV | 1.5                              | $\pm 20\%$              | 220  | 0.060  | 2,000                      | 1,000                            | 0.1                          | *2   |
| CB C3225T2R2MRV | 2.2                              | $\pm 20\%$              | 190  | 0.080  | 2,000                      | 930                              | 0.1                          | *2   |
| CB C3225T3R3MRV | 3.3                              | $\pm 20\%$              | 160  | 0.095  | 2,000                      | 850                              | 0.1                          | *2   |
| CB C3225T4R7MRV | 4.7                              | $\pm 20\%$              | 70   | 0.100  | 1,250                      | 830                              | 0.1                          | *2   |
| CB C3225T6R8MRV | 6.8                              | $\pm 20\%$              | 50   | 0.120  | 950                        | 760                              | 0.1                          | *2   |
| CB C3225T100□RV | 10                               | $\pm 10\%$ , $\pm 20\%$ | 23   | 0.133  | 900                        | 720                              | 0.1                          | *2   |
| CB C3225T150□RV | 15                               | $\pm 10\%$ , $\pm 20\%$ | 20   | 0.195  | 730                        | 590                              | 0.1                          | *2   |
| CB C3225T220□RV | 22                               | $\pm 10\%$ , $\pm 20\%$ | 17   | 0.27   | 620                        | 500                              | 0.1                          | *2   |
| CB C3225T330□RV | 33                               | $\pm 10\%$ , $\pm 20\%$ | 13   | 0.41   | 500                        | 400                              | 0.1                          | *2   |
| CB C3225T470□RV | 47                               | $\pm 10\%$ , $\pm 20\%$ | 10   | 0.67   | 390                        | 320                              | 0.1                          | *2   |
| CB C3225T680□RV | 68                               | $\pm 10\%$ , $\pm 20\%$ | 8.0  | 1.0  | 320                        | 260                              | 0.1                          | *2   |
| CB C3225T101□RV | 100                              | $\pm 10\%$ , $\pm 20\%$ | 6.0  | 1.4  | 270                        | 220                              | 0.1                          | *2   |
| CB C3225T221□RV | 220                              | $\pm 10\%$ , $\pm 20\%$ | 3.0  | 2.5  | 190                        | 170                              | 0.1                          | *2   |
| CB C3225T821□RV | 820                              | $\pm 10\%$ , $\pm 20\%$ | 1.8  | 12   | 110                        | 80                               | 0.1                          | *2   |
| CB C3225T102□RV | 1000                             | $\pm 10\%$ , $\pm 20\%$ | 1.6  | 13   | 100                        | 75                               | 0.1                          | *2   |

\* □ Please specify the Inductance tolerance code (Kor M)

※) The saturation current value (Idc1) is the DC current value having inductance decrease down to 30%. (at 20°C)

※) The temperature rise current value (Idc2) is the DC current value having temperature increase by 20°C. (at 20°C)

※) The rated current value is following either Idc1 or Idc2, which is the lower one.

Derating of Rated Current

CB series

Derating of current is necessary for CB series depending on ambient temperature. Please refer to the chart shown below for appropriate derating of current.

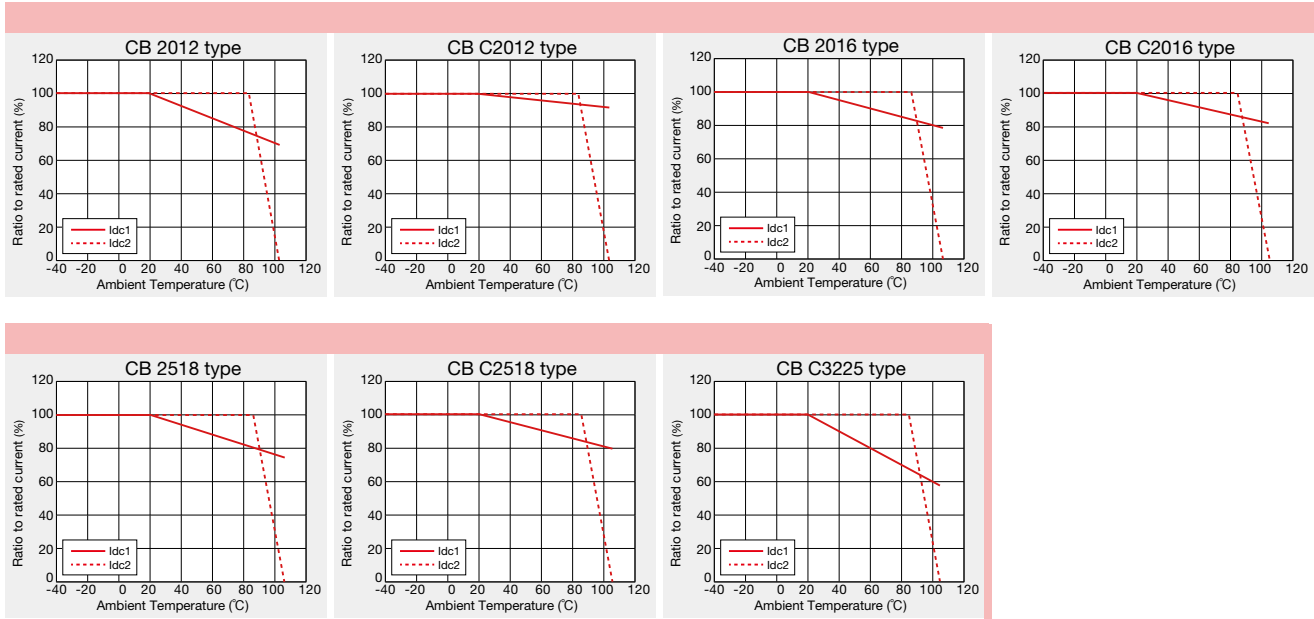

► This catalog contains the typical specification only due to the limitation of space. When you consider the purchase of our products, please check our product specification sheets. For details of each product (characteristics graph, reliability information, precautions for use, and so on), see our website (<http://www.ty-top.com/>).

# WIRE-WOUND CHIP INDUCTORS (LB SERIES), WIRE-WOUND CHIP POWER INDUCTORS (CB SERIES), WIRE-WOUND CHIP INDUCTORS FOR SIGNAL LINES (LB SERIES M TYPE)

## PACKAGING

### ① Minimum Quantity

| Type     | Standard Quantity [pcs] |               |
|----------|-------------------------|---------------|
|          | Paper Tape              | Embossed Tape |
| LB C3225 | —                       | 1000          |
| CB C3225 | —                       | 1000          |
| LB 3218  | —                       | 2000          |
| LB R2518 | —                       | 2000          |
| LB C2518 | —                       | 2000          |
| LB 2518  | —                       | 2000          |
| CB 2518  | —                       | 2000          |
| CB C2518 | —                       | 2000          |
| LBM2016  | —                       | 2000          |
| LB C2016 | —                       | 2000          |
| LB 2016  | —                       | 2000          |
| CB 2016  | —                       | 2000          |
| CB C2016 | —                       | 2000          |
| LB 2012  | —                       | 3000          |
| LB C2012 | —                       | 3000          |
| LB R2012 | —                       | 3000          |
| CB 2012  | —                       | 3000          |
| CB C2012 | —                       | 3000          |
| CB L2012 | 4000                    | —             |
| LB 1608  | 4000                    | —             |
| LBMF1608 | —                       | 3000          |
| CBMF1608 | —                       | 3000          |

### ② Tape material

#### ● Embossed tape

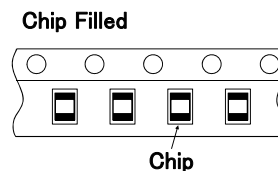
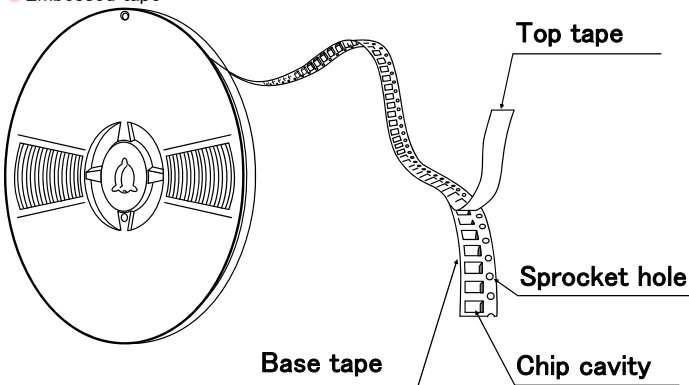

#### ● Card board carrier tape

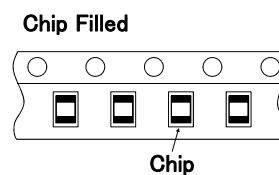
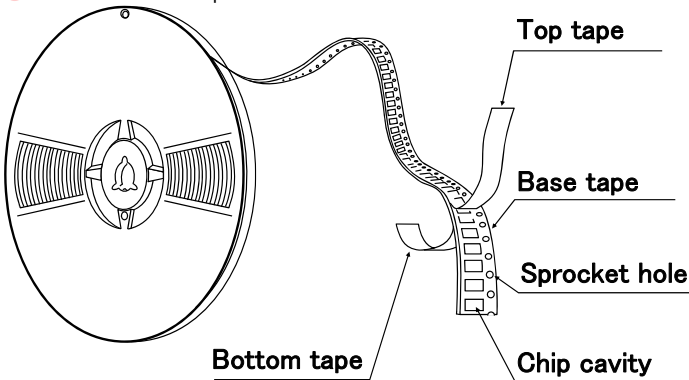

▶ This catalog contains the typical specification only due to the limitation of space. When you consider the purchase of our products, please check our specification. For details of each product (characteristics graph, reliability information, precautions for use, and so on), see our Web site (<http://www.ty-top.com/>).

### ③ Taping Dimensions

#### ● Embossed Tape (0.315 inches wide)

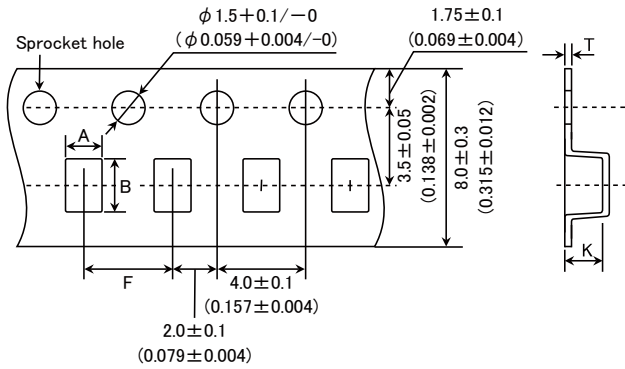

| Type   | Chip cavity                             |   | Insertion pitch                        | Tape thickness                           |                         |
|--|---|---|--|--|-------------------------|
|  | A                                       | B                                       | F                                      | T  | K                       |
| LBM2016  | $1.75 \pm 0.1$<br>( $0.069 \pm 0.004$ ) | $2.1 \pm 0.1$<br>( $0.083 \pm 0.004$ )  | $4.0 \pm 0.1$<br>( $0.157 \pm 0.004$ ) | $0.3 \pm 0.05$<br>( $0.012 \pm 0.002$ )  | 1.9max.<br>(0.075max.)  |
| LB C3225<br>CB C3225                                   | $2.8 \pm 0.1$<br>( $0.110 \pm 0.004$ )  | $3.5 \pm 0.1$<br>( $0.138 \pm 0.004$ )  | $4.0 \pm 0.1$<br>( $0.157 \pm 0.004$ ) | $0.3 \pm 0.05$<br>( $0.012 \pm 0.002$ )  | 4.0max.<br>(0.157max.)  |
| LB 3218  | $2.1 \pm 0.1$<br>( $0.083 \pm 0.004$ )  | $3.5 \pm 0.1$<br>( $0.138 \pm 0.004$ )  | $4.0 \pm 0.1$<br>( $0.157 \pm 0.004$ ) | $0.3 \pm 0.05$<br>( $0.012 \pm 0.002$ )  | 2.2max.<br>(0.087max.)  |
| LB 2518<br>CB 2518<br>LB C2518<br>CB C2518<br>LB R2518 | $2.15 \pm 0.1$<br>( $0.085 \pm 0.004$ ) | $2.7 \pm 0.1$<br>( $0.106 \pm 0.004$ )  | $4.0 \pm 0.1$<br>( $0.157 \pm 0.004$ ) | $0.3 \pm 0.05$<br>( $0.012 \pm 0.002$ )  | 2.2max.<br>(0.087max.)  |
| LB 2016<br>CB 2016<br>LB C2016<br>CB C2016             | $1.75 \pm 0.1$<br>( $0.069 \pm 0.004$ ) | $2.1 \pm 0.1$<br>( $0.083 \pm 0.004$ )  | $4.0 \pm 0.1$<br>( $0.157 \pm 0.004$ ) | $0.3 \pm 0.05$<br>( $0.012 \pm 0.002$ )  | 1.9max.<br>(0.075max.)  |
| LB 2012<br>CB 2012<br>LB C2012<br>CB C2012<br>LB R2012 | $1.45 \pm 0.1$<br>( $0.057 \pm 0.004$ ) | $2.25 \pm 0.1$<br>( $0.089 \pm 0.004$ ) | $4.0 \pm 0.1$<br>( $0.157 \pm 0.004$ ) | $0.25 \pm 0.05$<br>( $0.010 \pm 0.002$ ) | 1.45max.<br>(0.057max.) |
| LBMF1608<br>CBMF1608                                   | $1.1 \pm 0.1$<br>( $0.043 \pm 0.004$ )  | $1.9 \pm 0.1$<br>( $0.075 \pm 0.004$ )  | $4.0 \pm 0.1$<br>( $0.157 \pm 0.004$ ) | $0.25 \pm 0.05$<br>( $0.010 \pm 0.002$ ) | 1.2max.<br>(0.047max.)  |

Unit: mm (inch)

#### ● Card board carrier tape (0.315 inches wide)

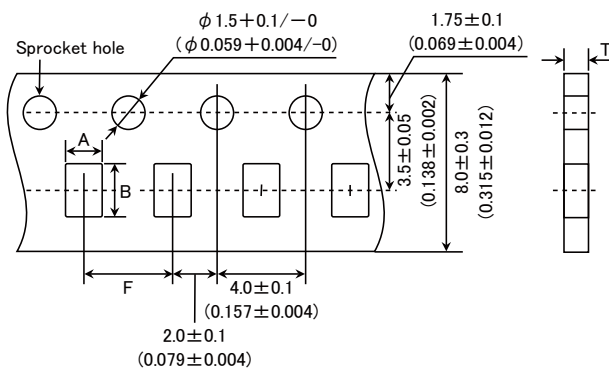

| Type     | Chip cavity                             |  | Insertion pitch                        | Tape thickness         |
|----------|---|--|--|------------------------|
|          | A                                       | B                                      | F                                      | T                      |
| CB L2012 | $1.55 \pm 0.1$<br>( $0.061 \pm 0.004$ ) | $2.3 \pm 0.1$<br>( $0.091 \pm 0.004$ ) | $4.0 \pm 0.1$<br>( $0.157 \pm 0.004$ ) | 1.1max.<br>(0.043max.) |
| LB 1608  | $1.0 \pm 0.1$<br>( $0.039 \pm 0.004$ )  | $1.8 \pm 0.1$<br>( $0.071 \pm 0.004$ ) | $4.0 \pm 0.1$<br>( $0.157 \pm 0.004$ ) | 1.1max.<br>(0.043max.) |

Unit: mm (inch)

#### ④ Leader and Blank Portion

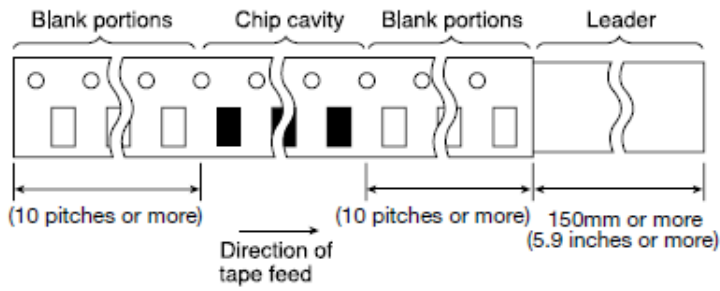

#### ⑤ Reel Size

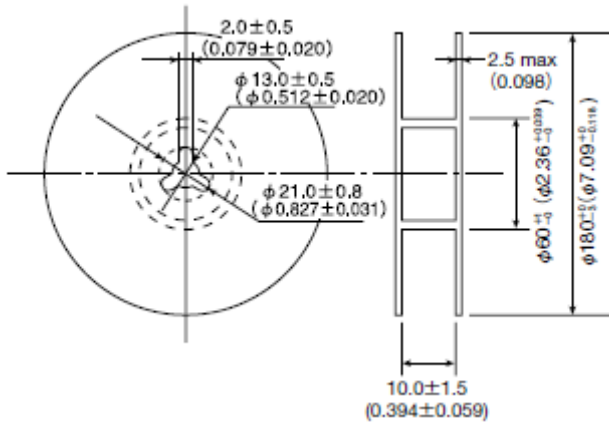

#### ⑥ Top Tape Strength

The top tape requires a peel-off force 0.2 to 0.7N in the direction of the arrow as illustrated below.

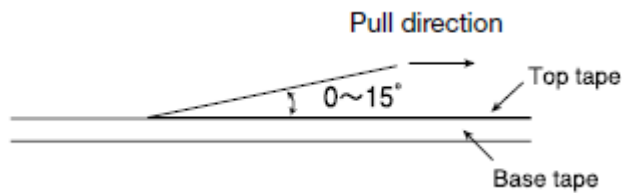

**WIRE-WOUND CHIP INDUCTORS (LB SERIES),  
WIRE-WOUND CHIP POWER INDUCTORS (CB SERIES),  
WIRE-WOUND CHIP INDUCTORS FOR SIGNAL LINES (LB SERIES M TYPE)**

■ RELIABILITY DATA

| 1. Operating temperature Range |                               |   |
|--------------------------------|-------------------------------|---|
| Specified Value                | LB, LBC, LBR Series           | -40~ +105°C (Including self-generated heat) |
|                                | CB, CBC Series                |   |
|                                | LBM Series                    |   |
| Test Methods and Remarks       | Including self-generated heat |   |

| 2. Storage Temperature Range (after soldering) |   |            |
|--|---|------------|
| Specified Value                                | LB, LBC, LBR Series   | -40~ +85°C |
|  | CB, CBC Series  |            |
|  | LBM Series  |            |
| Test Methods and Remarks                       | LB, CB Series :<br>Please refer the term of "7. storage conditions" in precautions. |            |

| 3. Rated Current |                     |                                |
|------------------|---------------------|--------------------------------|
| Specified Value  | LB, LBC, LBR Series | Within the specified tolerance |
|                  | CB, CBC Series      |                                |
|                  | LBM Series          |                                |

| 4. Inductance            |   |                                |
|--------------------------|---|--------------------------------|
| Specified Value          | LB, LBC, LBR Series   | Within the specified tolerance |
|                          | CB, CBC Series  |                                |
|                          | LBM Series  |                                |
| Test Methods and Remarks | LB・LBC・LBR・CB・CBC・LBM Series<br>Measuring equipment : LCR Meter (HP4285A or its equivalent) |                                |

| 5. Q                     |   |                                |
|--------------------------|---|--------------------------------|
| Specified Value          | LB, LBC, LBR Series   | -                              |
|                          | CB, CBC Series  |                                |
|                          | LBM Series  | Within the specified tolerance |
| Test Methods and Remarks | LBM Series<br>Measuring equipment : LCR Meter (HP4285A or its equivalent) |                                |

| 6. DC Resistance         |  |                                |
|--------------------------|--|--------------------------------|
| Specified Value          | LB, LBC, LBR Series  | Within the specified tolerance |
|                          | CB, CBC Series   |                                |
|                          | LBM Series   |                                |
| Test Methods and Remarks | Measuring equipment : DC Ohmmeter (HIOKI 3227 or its equivalent) |                                |

| 7. Self-Resonant Frequency |  |                                |
|----------------------------|--|--------------------------------|
| Specified Value            | LB, LBC, LBR Series  | Within the specified tolerance |
|                            | CB, CBC Series   |                                |
|                            | LBM Series   |                                |
| Test Methods and Remarks   | Measuring equipment : Impedance analyzer (HP4291A or its equivalent) |                                |

▶ This catalog contains the typical specification only due to the limitation of space. When you consider the purchase of our products, please check our specification.  
For details of each product (characteristics graph, reliability information, precautions for use, and so on), see our Web site (<http://www.ty-top.com/>).

| 8. Temperature Characteristic |  |                                     |         |         |                                       |
|-------------------------------|--|-------------------------------------|---------|---------|---------------------------------------|
| Specified Value               | LBM2016  |                                     |         |         | Inductance change : Within $\pm 10\%$ |
|                               | LB2012   | LBR2012                             | CB2012  | LB2016  | Inductance change : Within $\pm 20\%$ |
|                               | CB2016   | LB2518                              | LBR2518 | CB2518  |                                       |
|                               | LBC3225  | CBC3225                             |         |         |                                       |
|                               | LBC2016  | CBC2016                             | LBC2518 | CBC2518 | Inductance change : Within $\pm 25\%$ |
| LB3218                        |  |                                     |         |         |                                       |
|                               | LBC2012  | CBC2012                             |         |         | Inductance change : Within $\pm 35\%$ |
| Test Methods and Remarks      | Change of maximum inductance deviation in step 1-5 |                                     |         |         |                                       |
|                               | Step   | Temperature ( $^{\circ}\text{C}$ )  |         |         |                                       |
|                               |  | LB, CB Serie                        |         |         |                                       |
|                               | 1  | 20                                  |         |         |                                       |
|                               | 2  | -40                                 |         |         |                                       |
|                               | 3  | 20 (Reference temperature)          |         |         |                                       |
|                               | 4  | +85 (Maximum operating temperature) |         |         |                                       |
| 5                             | 20   |                                     |         |         |                                       |

| 9. Resistance to Flexure of Substrate |   |  |
|---------------------------------------|---|--|
| Specified Value                       | LB, LBC, LBR Series   |  |
|                                       | CB, CBC Series  |  |
|                                       | LBM Series  |  |
| Test Methods and Remarks              | Warp : 2mm (LB·LBC·LBR·CB·CBC·LBM Series)                                 |  |
|                                       | Test substrate : Board according to JIS C0051                             |  |
|                                       | Thickness : 1.0mm   |  |
|                                       | <p>Pressing jig<br/>10 20<br/>R340<br/>Board<br/>R5<br/>45±2mm 45±2mm</p> |  |

| 10. Body Strength        |                       |  |
|--------------------------|-----------------------|--|
| Specified Value          | LB, LBC, LBR Series   |  |
|                          | CB, CBC Series        |  |
|                          | LBM Series            |  |
| Test Methods and Remarks | LB·LBC·LBR·CB·CBC·LBM |  |
|                          | Applied force : 10N   |  |
|                          | Duration : 10sec.     |  |

| 11. Adhesion of terminal electrode |   |  |
|------------------------------------|---|--|
| Specified Value                    | LB, LBC, LBR Series                       |  |
|                                    | CB, CBC Series                            |  |
|                                    | LBM Series                                |  |
| Test Methods and Remarks           | LB·LBC·LBR·CB·CBC·CBL·LBM                 |  |
|                                    | Applied force : 10N to X and Y directions |  |
|                                    | Duration : 5 sec.                         |  |
|                                    | Test substrate : Printed board            |  |

| 12. Resistance to vibration |   |  |
|-----------------------------|---|--|
| Specified Value             | LB, LBC, LBR Series   | Inductance change : Within $\pm 20\%$<br>No significant abnormality in appearance. |
|                             | CB, CBC Series  |  |
|                             | LBM Series  | Inductance change : Within $\pm 20\%$<br>No significant abnormality in appearance. |
| Test Methods and Remarks    | LB•LBR•LBC•CB•CBC•LBM : According to JIS C5102 clause 8.2.<br>Vibration type : A<br>Directions : 2 hrs each in X, Y and Z directions. Total: 6 hrs<br>Frequency range : 10 to 55 to 10 Hz (1min.)<br>Amplitude : 1.5mm<br>Mounting method : Soldering onto printed board<br>Recovery : At least 2 hrs of recovery under the standard condition after the test, followed by the measurement within 48 hrs. |  |
| 13. Drop test               |   |  |
| Specified Value             | LB, LBC, LBR Series   | —  |
|                             | CB, CBC Series  |  |
|                             | LBM Series  |  |
| 14. Solderability           |   |  |
| Specified Value             | LB, LBC, LBR Series   | At least 90% of surface of terminal electrode is covered by new                    |
|                             | CB, CBC Series  |  |
|                             | LBM Series  |  |
| Test Methods and Remarks    | LB•LBC•LBR•CB•CBC•CBL•LBM :<br>Solder temperature : $245 \pm 5^\circ\text{C}$<br>Duration : $5 \pm 0.5\text{sec}$<br>Flux : Methanol solution with 25% of colophony   |  |
| 15. Resistance to soldering |   |  |
| Specified Value             | LB, LBC, LBR Series   | Inductance change : Within $\pm 20\%$  |
|                             | CB, CBC Series  |  |
|                             | LBM Series  | Inductance change : Within $\pm 20\%$  |
| Test Methods and Remarks    | LB•LBC•LBR•CB•CBC•CBL•LBM :<br>3 times of reflow oven at $230^\circ\text{C}$ MIN for 40sec. with peak temperature at $260^\circ\text{C}$ for 5sec.  |  |
| 16. Resistance to solvent   |   |  |
| Specified Value             | LB, LBC, LBR Series   | —  |
|                             | CB, CBC Series  |  |
|                             | LBM Series  |  |
| Test Methods and Remarks    | Solvent temperature : Room temperature<br>Type of solvent : Isopropyl alcohol<br>Cleaning conditions : 90s. Immersion and cleaning.   |  |
| 17. Thermal shock           |   |  |
| Specified Value             | LB, LBC, LBR Series   | Inductance change : Within $\pm 20\%$<br>No significant abnormality in appearance. |
|                             | CB, CBC Series  |  |
|                             | LBM Series  |  |
| Test Methods and Remarks    | LB•LBC•LBR•CB•CBC•CBL•LBM : $-40 \sim +85^\circ\text{C}$ , maintain times 30min. ,100 cycle<br>Recovery : At least 2 hrs of recovery under the standard condition after the test, followed by the measurement within 48 hrs.  |  |

| 18.Damp heat life test   |   |  |
|--------------------------|---|--|
| Specified Value          | LB, LBC, LBR Series   | Inductance change : Within $\pm 20\%$<br>No significant abnormality in appearance. |
|                          | CB, CBC Series  |  |
|                          | LBM Series  |  |
| Test Methods and Remarks | Temperature : $60 \pm 2^\circ\text{C}$<br>Humidity : $90 \sim 95\% \text{RH}$<br>Duration : 1000 hrs<br>Recovery : At least 2 hrs of recovery under the standard condition after the test, followed by the measurement within 48 hrs. |  |

| 19.Loading under damp heat life test |  |  |
|--------------------------------------|--|--|
| Specified Value                      | LB, LBC, LBR Series  | Inductance change : Within $\pm 20\%$<br>No significant abnormality in appearance. |
|                                      | CB, CBC Series   |  |
|                                      | LBM Series   |  |
| Test Methods and Remarks             | Temperature : $60 \pm 2^\circ\text{C}$<br>Humidity : $90 \sim 95\% \text{RH}$<br>Duration : 1000 hrs<br>Applied current : Rated current<br>Recovery : At least 2 hrs of recovery under the standard condition after the test, followed by the measurement within 48 hrs. |  |

| 20.High temperature life test |  |  |
|-------------------------------|--|--|
| Specified Value               | LB, LBC, LBR Series  | —  |
|                               | CB, CBC Series   | Inductance change : Within $\pm 20\%$<br>No significant abnormality in appearance. |
|                               | LBM Series   |  |
| Test Methods and Remarks      | Temperature : $85 \pm 2^\circ\text{C}$<br>Duration : 1000 hrs<br>Recovery : At least 2 hrs of recovery under the standard condition after the test, followed by the measurement within 48 hrs. |  |

| 21.Loading at high temperature life test |   |  |
|--|---|--|
| Specified Value                          | LB, LBC, LBR Series   | Inductance change : Within $\pm 20\%$<br>No significant abnormality in appearance. |
|  | CB, CBC Series  |  |
|  | LBM Series  | —  |
| Test Methods and Remarks                 | Temperature : $85 \pm 2^\circ\text{C}$<br>Duration : 1000 hrs<br>Applied current : Rated current<br>Recovery : At least 2 hrs of recovery under the standard condition after the test, followed by the measurement within 48 hrs. |  |

| 22.Low temperature life test |   |  |
|------------------------------|---|--|
| Specified Value              | LB, LBC, LBR Series   | Inductance change : Within $\pm 20\%$<br>No significant abnormality in appearance. |
|                              | CB, CBC Series  |  |
|                              | LBM Series  |  |
| Test Methods and Remarks     | Temperature : $-40 \pm 2^\circ\text{C}$<br>Duration : 1000 hrs<br>Recovery : At least 2 hrs of recovery under the standard condition after the test, followed by the measurement within 48 hrs. |  |

| 23.Standard condition |                     |   |
|-----------------------|---------------------|---|
| Specified Value       | LB, LBC, LBR Series | Standard test conditions<br>Unless specified, Ambient temperature is $20 \pm 15^\circ\text{C}$ and the Relative humidity is $65 \pm 20\%$ . If there is any doubt about the test results, further measurement shall be had within the following limits:<br>Ambient Temperature: $20 \pm 2^\circ\text{C}$<br>Relative humidity: $65 \pm 5\%$<br>Inductance value is based on our standard measurement systems. |
|                       | CB, CBC Series      |   |
|                       | LBM Series          |   |

# WIRE-WOUND CHIP INDUCTORS (LB SERIES), WIRE-WOUND CHIP POWER INDUCTORS (CB SERIES), WIRE-WOUND CHIP INDUCTORS FOR SIGNAL LINES (LB SERIES M TYPE)

## ■ PRECAUTIONS

| 1. Circuit Design                         |  |
|---|--|
| Precautions                               | <p>◆Operating environment</p> <p>1. The products listed in this catalogue are intended for use in general electronic equipment (e.g., AV equipment, OA equipment, home electric appliances, office equipment, information and communication equipment), general medical equipment, industrial equipment, and automotive interior applications, etc.</p> <p>Please be sure to contact TAIYO YUDEN for further information before using the products for any equipment which may directly cause loss of human life or bodily injury (e.g., specially controlled medical equipment, transportation equipment including, without limitation, automotive powertrain control system, train control system, and ship control system, traffic signal equipment).</p> <p>Please do not incorporate our products into any equipment requiring high levels of safety and/or reliability (e.g., aerospace equipment, aviation equipment, nuclear control equipment, undersea equipment, military equipment, etc.).</p> |
| 2. PCB Design                             |  |
| Precautions                               | <p>◆Land pattern design</p> <p>1. Please contact any of our offices for a land pattern, and refer to a recommended land pattern of a right figure or specifications.</p>   |
| Technical considerations                  | <p>PRECAUTIONS<br/>【Recommended Land Patterns】</p> <p>Surface Mounting</p> <ul style="list-style-type: none"> <li>• Mounting and soldering conditions should be checked beforehand.</li> <li>• Applicable soldering process to those products is reflow soldering only.</li> </ul>   |
| 3. Considerations for automatic placement |  |
| Precautions                               | <p>◆Adjustment of mounting machine</p> <p>1. Excessive impact load should not be imposed on the products when mounting onto the PC boards.</p> <p>2. Mounting and soldering conditions should be checked beforehand.</p>   |
| Technical considerations                  | <p>1. When installing products, care should be taken not to apply distortion stress as it may deform the products.</p>   |
| 4. Soldering                              |  |
| Precautions                               | <p>◆Reflow soldering( LB and CB Types)</p> <p>1. For reflow soldering with either leaded or lead-free solder, the profile specified in "point for controlling" is recommended.</p> <p>◆Recommended conditions for using a soldering iron</p> <p>1. Put the soldering iron on the land-pattern. Soldering iron's temperature – Below 350°C Duration-3 seconds or less. The soldering iron should not come in contact with inductor directly.</p>  |
| Technical considerations                  | <p>◆Reflow soldering( LB and CB Types)</p> <p>1. Reflow profile</p> <p>Temperature [°C]</p> <p>Heating Time [sec]</p> <p>150~180</p> <p>90±30sec</p> <p>30±10sec</p> <p>230°C min</p> <p>5sec max</p> <p>Peak: 260+0/-5°C</p> <p>◆Recommended conditions for using a soldering iron</p> <p>1. Components can be damaged by excessive heat where soldering conditions exceed the specified range.</p>   |
| 5. Cleaning                               |  |
| Precautions                               | <p>◆Cleaning conditions</p> <p>Washing by supersonic waves shall be avoided.</p>   |
| Technical considerations                  | <p>◆Cleaning conditions</p> <p>If washed by supersonic waves, the products might be broken.</p>  |

## 6. Handling

|                          |  |
|--------------------------|--|
| Precautions              | <ul style="list-style-type: none"><li>◆ Handling<ul style="list-style-type: none"><li>1. Keep the inductors away from all magnets and magnetic objects.</li></ul></li><li>◆ Breakaway PC boards ( splitting along perforations)<ul style="list-style-type: none"><li>1. When splitting the PC board after mounting inductors, care should be taken not to give any stresses of deflection or twisting to the board.</li><li>2. Board separation should not be done manually, but by using the appropriate devices.</li></ul></li><li>◆ Mechanical considerations<ul style="list-style-type: none"><li>1. Please do not give the inductors any excessive mechanical shocks.</li></ul></li></ul> |
| Technical considerations | <ul style="list-style-type: none"><li>◆ Handling<ul style="list-style-type: none"><li>1. There is a case that a characteristic varies with magnetic influence.</li></ul></li><li>◆ Breakaway PC boards ( splitting along perforations)<ul style="list-style-type: none"><li>1. Planning pattern configurations and the position of products should be carefully performed to minimize stress.</li></ul></li><li>◆ Mechanical considerations<ul style="list-style-type: none"><li>1. There is a case to be damaged by a mechanical shock.</li></ul></li></ul>   |

## 7. Storage conditions

|                          |  |
|--------------------------|--|
| Precautions              | <ul style="list-style-type: none"><li>◆ Storage<ul style="list-style-type: none"><li>1. To maintain the solderability of terminal electrodes and to keep the packing material in good condition, temperature and humidity in the storage area should be controlled.<ul style="list-style-type: none"><li>• Recommended conditions<br/>Ambient temperature: 0~40°C / Humidity: Below 70% RH</li></ul></li></ul></li></ul> <p>The ambient temperature must be kept below 30°C even under ideal storage conditions, solderability of products electrodes may decrease as time passes. For this reason, These series should be used within 6 months from the time of delivery.</p> |
| Technical considerations | <ul style="list-style-type: none"><li>◆ Storage<ul style="list-style-type: none"><li>1. Under a high temperature and humidity environment, problems such as reduced solderability caused by oxidation of terminal electrodes and deterioration of taping/packaging materials may take place.</li></ul></li></ul>   |







## Looking for pricing, stock, or lifecycle information?

Click below to explore more details on WIN SOURCE:

 [View CBC2012T2R2MV](#) on WIN SOURCE

 [Taiyo Yuden](#) Information

## Optimize Your Supply Chain with WIN SOURCE Solutions

-  Global Sourcing Solution
-  Obsolete Management
-  Cost Control Management
-  Shortage Management
-  Alternative Solution
-  Excess Inventory Management