

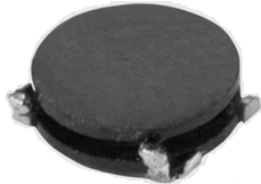

**THE DATASHEET OF
CDH38D11SLDNP-220MC**



SMD Power Inductor CDH38D11/SLD



Description

- Ferrite drum core construction.
- Magnetically unshielded.
- L × W × H: 4.0 × 4.0 × 1.2mm Max.
- Product weight: 58mg(Ref.)
- Moisture Sensitivity Level: 1
- RoHS compliance.

Environmental Data

- Operating temperature range: -40°C~+105°C (including coil's self temperature rise)
- Storage temperature range: -40°C~+105°C
- Solder reflow temperature: 260 °C peak.

Packaging

- Carrier tape and reel packaging.
- 7.0" diameter reel
- 1500pcs per reel

Applications

- Ideally used in Mobilephone, PDA, MP3, DSC/ DVC, HDD etc as DC-DC converter inductors.

Dimension - [mm]

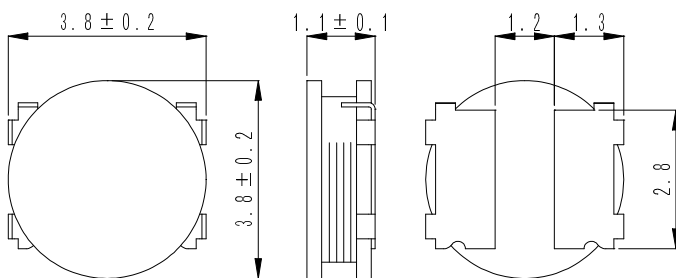

Land pattern and Schematics - [mm]

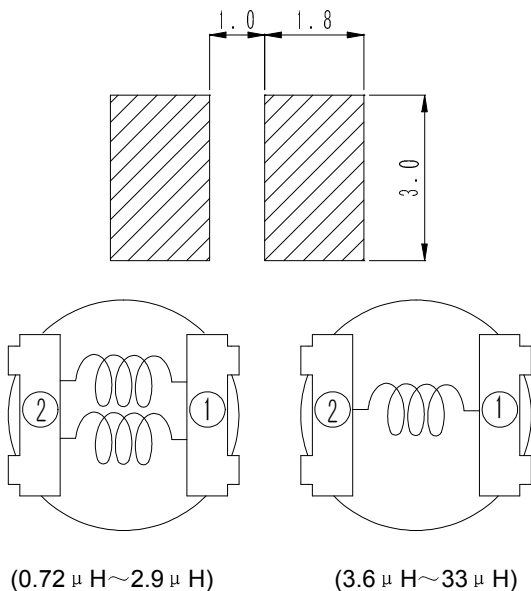

SMD Power Inductor CDH38D11/SLD



Electrical Characteristics

Part Name	Stamp	Inductance (μ H) [within] ※1	D.C.R.(Ω) Max. (Typ.) (at 20°C)	Saturation Current (A) ※2	Temperature Rise Current (A) ※3
CDH38D11SLDNP-R72MC	R72	0.72 \pm 20%	36.3m(29m)	2.40	3.40
CDH38D11SLDNP-1R0MC	1R0	1.0 \pm 20%	41.3m(33m)	2.00	3.30
CDH38D11SLDNP-1R4MC	1R4	1.4 \pm 20%	55.0m(44m)	1.80	2.70
CDH38D11SLDNP-1R9MC	1R9	1.9 \pm 20%	66.3m(53m)	1.45	2.30
CDH38D11SLDNP-2R4MC	2R4	2.4 \pm 20%	93.8m(75m)	1.30	1.88
CDH38D11SLDNP-2R9MC	2R9	2.9 \pm 20%	97.5m(78m)	1.20	1.86
CDH38D11SLDNP-3R6MC	3R6	3.6 \pm 20%	129.6m(108m)	1.10	1.47
CDH38D11SLDNP-4R2MC	4R2	4.2 \pm 20%	135.6m(113m)	1.00	1.41
CDH38D11SLDNP-5R1MC	5R1	5.1 \pm 20%	171.6m(143m)	0.90	1.30
CDH38D11SLDNP-5R8MC	5R8	5.8 \pm 20%	182.4m(152m)	0.84	1.25
CDH38D11SLDNP-7R2MC	7R2	7.2 \pm 20%	228m(190m)	0.75	0.92
CDH38D11SLDNP-8R2MC	8R2	8.2 \pm 20%	252m(210m)	0.70	0.86
CDH38D11SLDNP-100MC	100	10 \pm 20%	336m(280m)	0.64	0.78
CDH38D11SLDNP-120MC	120	12 \pm 20%	0.38(0.32)	0.60	0.75
CDH38D11SLDNP-150MC	150	15 \pm 20%	0.49(0.41)	0.52	0.67
CDH38D11SLDNP-180MC	180	18 \pm 20%	0.55(0.46)	0.48	0.57
CDH38D11SLDNP-220MC	220	22 \pm 20%	0.73(0.61)	0.44	0.49
CDH38D11SLDNP-270MC	270	27 \pm 20%	0.84(0.70)	0.42	0.46
CDH38D11SLDNP-330MC	330	33 \pm 20%	1.0(0.83)	0.36	0.45

※1. Inductance measuring condition: at 100kHz.

※2. Saturation current: The value of D.C. current when the inductance decreases to 70% of it's nominal value.

※3. Temperature rise current: The value of D.C. current when the temperature rise is $\Delta t=40^{\circ}\text{C}$ ($T_a=20^{\circ}\text{C}$).

SMD Power Inductor CDH38D11/SLD



Saturation Current & Temperature Rise Graph

— L (20°C) — L (105°C) — ΔT

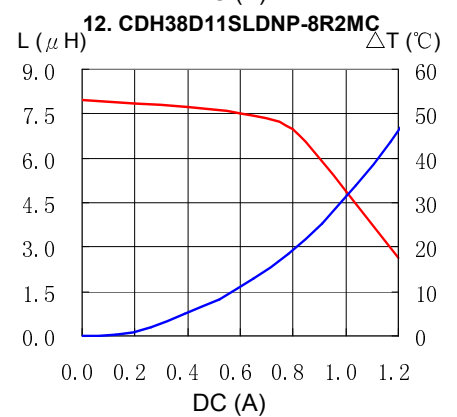
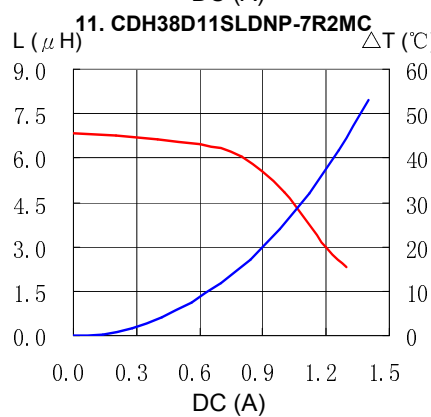
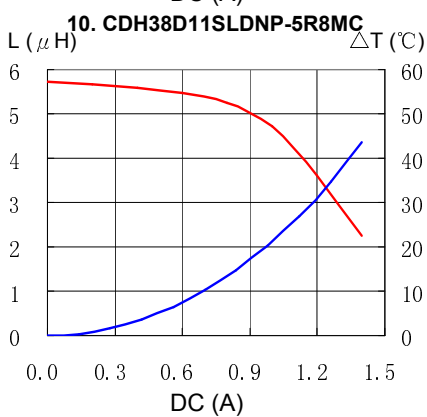
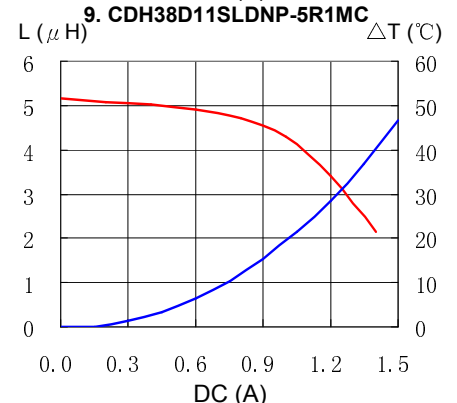
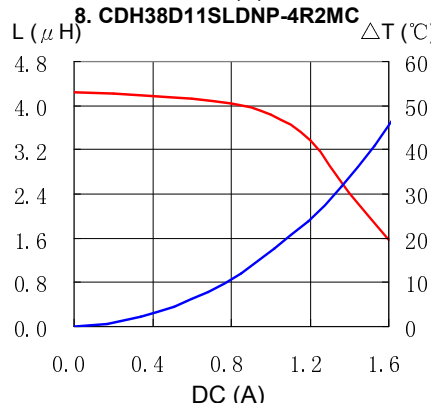
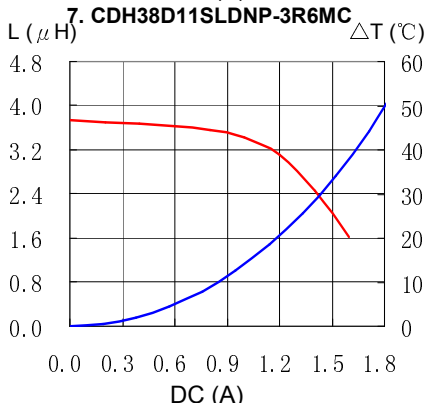
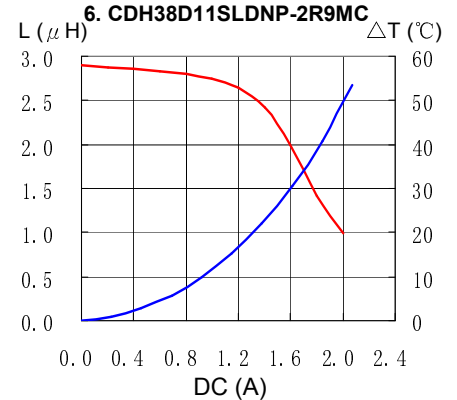
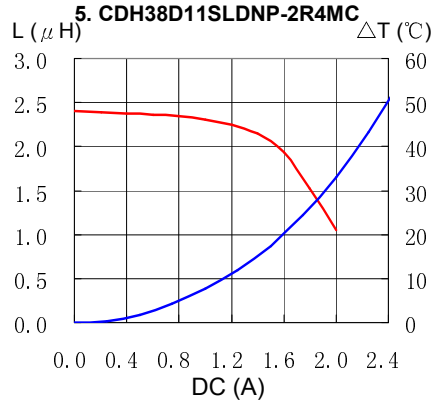
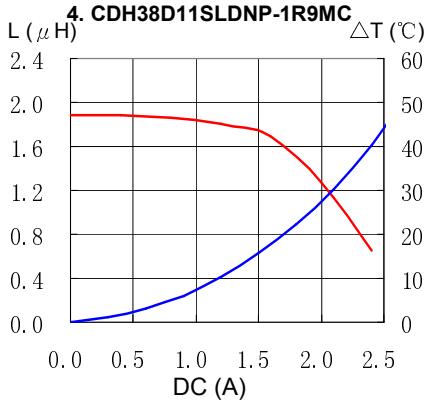
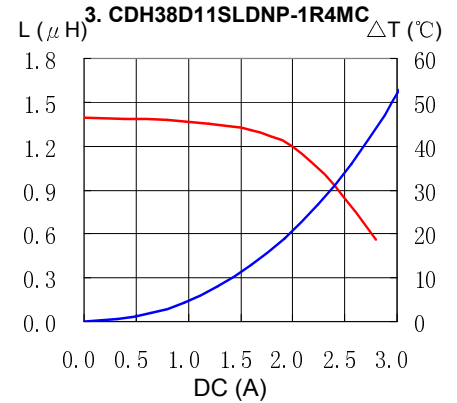
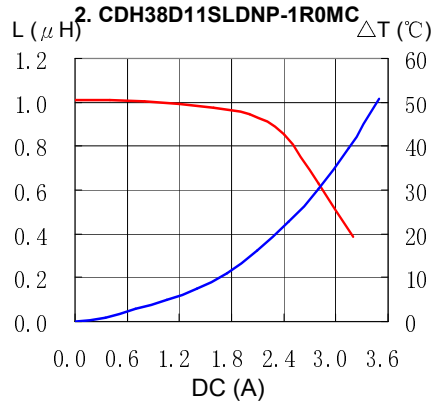
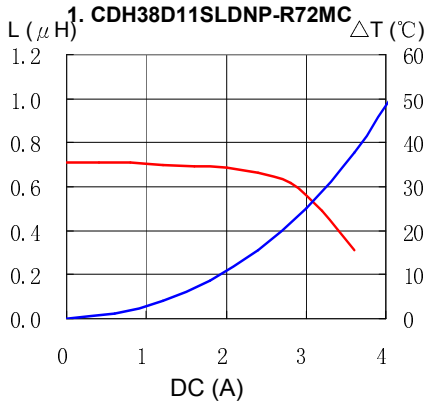

SMD Power Inductor CDH38D11/SLD



Saturation Current & Temperature Rise Graph

— L (20°C) — L (105°C) — ΔT

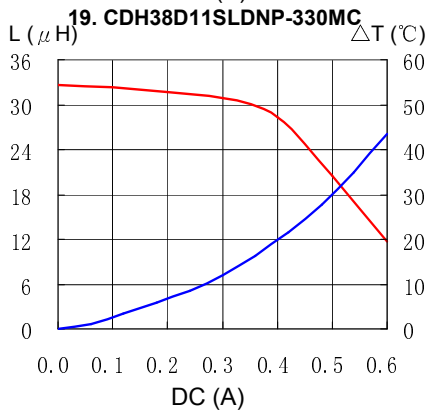
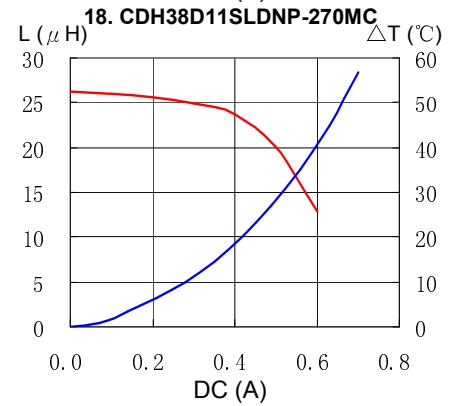
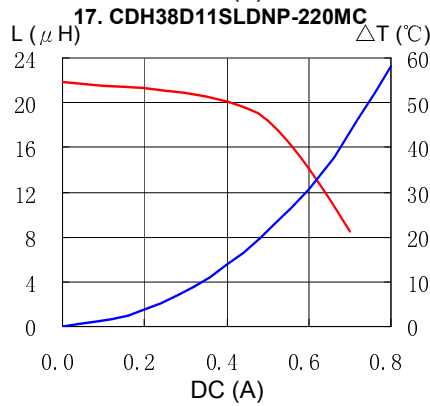
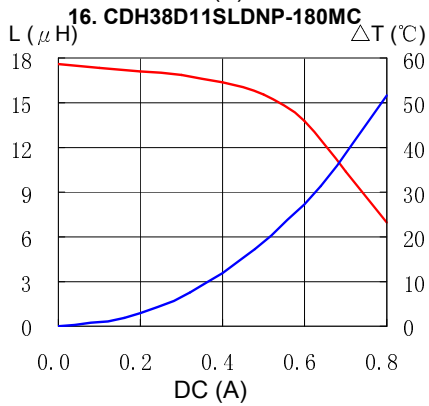
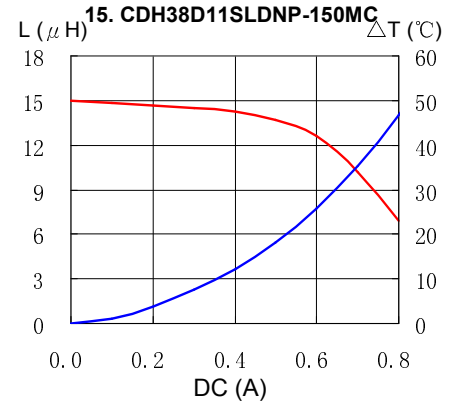
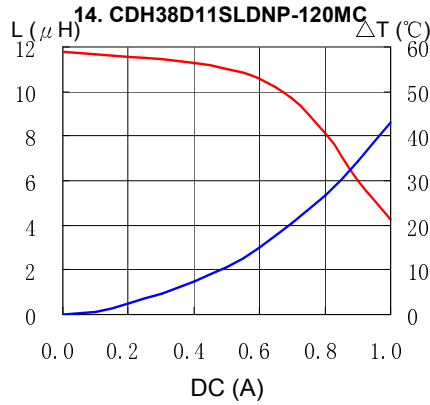
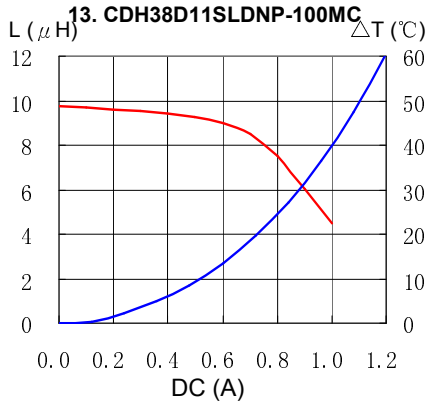

SMD Power Inductor CDH38D11/SLD



Solder Reflow Condition

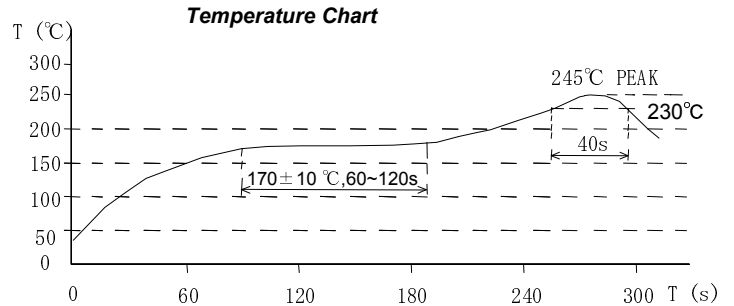
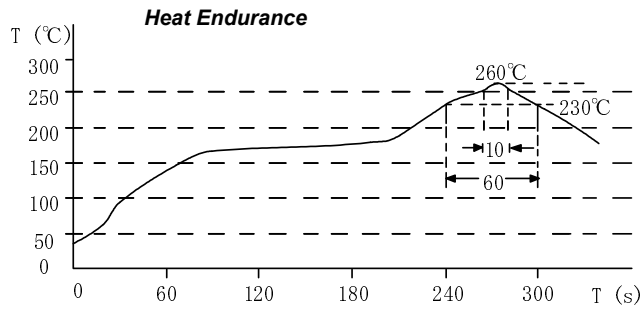

Please refer to the sales offices on our website - <http://www.sumida.com>

Hong Kong

Tel.+852-2880-6781
FAX.+852-2565-9600
sales@hk.sumida.com

Saitama(Japan)

Tel.+81-48-691-7300
FAX.+81-48-691-7340
sales@jp.sumida.com

Chicago

Tel.+1-847-545-6700
FAX. +1-847-545-6720
sales@us.sumida.com

Shanghai

Tel.+86-21-5836-3299
FAX.+86-21-5836-3266
shanghai.sales@cn.sumida.com

Seoul

Tel.+82-2-6237-0777
FAX.+82-2-6237-0778
sales@kr.sumida.com

Oberzell

Tel.+49-8591-937-0
FAX. +49-8591-937-103
contact@eu.sumida.com

Shenzhen

Tel.+86-755-8291-0228
FAX.+86-755-8291-0338
shenzhen.sales@cn.sumida.com

Singapore

Tel.+65-6296-3388
FAX.+65-6841-4426
sales@sg.sumida.com

Neumarkt

Tel.+49-9181-4509-110
FAX. +49-9181-4509-310
infocomp@eu.sumida.com

Taipei

Tel.+886-2-8751-2737
FAX.+886-2-8751-2738
sales@tw.sumida.com

San Jose

Tel.+1-408-321-9660
FAX.+1-408-321-9308
sales@us.sumida.com

Looking for pricing, stock, or lifecycle information?

Click below to explore more details on WIN SOURCE:

- [View CDH38D11SLDNP-220MC on WIN SOURCE](#)
- [Sumida America Components Inc. Information](#)

Optimize Your Supply Chain with WIN SOURCE Solutions

- ✓ Global Sourcing Solution
- ✓ Obsolete Management
- ✓ Cost Control Management
- ✓ Shortage Management
- ✓ Alternative Solution
- ✓ Excess Inventory Management