



**THE DATASHEET OF
NAU88L25YGB**



Ultra-Low Power Audio CODEC for Headphone/Headsets Application With 124dB Class G Headphone Drive and Advanced Headset Features

Description

The NAU88L25B® is an Ultra-Low-Power High-Performance Audio CODEC Ground-Referenced Headphone Amplifier with Advanced Headset Detection. The single-chip solution with microphone and ground detection and switching capabilities is designed for smartphones, tablets, Personal Computers (PCs), and other portable devices that support both analog and digital audio functions. The NAU88L25B is a cost-optimized solution for audio jack applications that benefit from enhanced audio quality and more integrated detection and suppression functions. Additionally, when used in combination with the Nuvoton NuMicro® NUC123, an ARM® Cortex MO-based microprocessor, the NAU88L25B Audio CODEC provides an easy-to-implement design solution for USB headphones.

The highly-integrated NAU88L25B features one I2S/PCM Interface, one digital mixer, two high-quality audio Digital-to-Analog Converters (DACs), one high-quality audio Analog-to-Digital Converter (ADC), one monophonic differential analog microphone input, two analog single-ended microphone inputs, and one stereophonic Class G headphone amplifier with automatic headset detection. After automatically detecting which type of headset is in use—Stereo headphone, Nokia-type headsets, or Apple-type headsets—the NAU88L25B switches internal connections to support the appropriate format.

The advanced on-chip Digital Signal Processing (DSP) engine includes a Dynamic Range Compressor (DRC), and Programmable Bi-Quad Filters for various types of filters to optimize audio quality and eliminate undesirable frequency components. The NAU88L25B Audio CODEC provides comprehensive headset detection features that support jack insertion/ejection, microphone detection, distinct key / short key / long key / key release detection and Crosstalk detection/suppression. The chip also provides an integrated Frequency Locked Loop (FLL) to support various clocks.

The NAU88L25 operates with analog supply voltages from 1.6V to 1.8V, while the digital core can operate from 1.1V to 1.98V to conserve power. The NAU88L25 is specified for operation from -40°C to +85°C, and is available in QFN 32 or CSP package with 0.4mm pitch.

Features

- DAC with auto attenuate : 124dB SNR; without auto mute: 113dB SNR, (A-weighted) @ 0dB gain, 1.8V and -89dB THDN @ 20mW and RL= 32Ω, DAC playback to headphone output mode
- ADC : 101dB SNR (A-weighted) @ 0dB MIC gain, 1.8V, Fs = 48kHz and -91dB THD , 1.8V, MIC gain 0dB, OSR 128x
- One Digital I2S/PCM I/O port
- Dynamic Range Compressor (DRC)
- Programmable Biquad filter
- One Headset Mic: One Differential Analog Mic input, Line-input or two single-ended Mic input
- One Class G Stereo Headphone Amplifier(28mW @ 32Ω, 1% THD+N)
- Sampling rate from 8K to 192 KHz
- Autonomous Headset Microphone & Ground Detection and Switching
- Jack Insertion and Ejection Detection
- Distinct Keys Detection
- Package : 32 Pin QFN package, and 42 Balls WLCSP with 0.4mm Pitch

Applications

- Ultra-Portable Laptop
- Mobile Device
- Wireless or USB Headphone
- Smart Remote Controller
- Gaming Controller

Block Diagram

The NAU88L25B Audio CODEC is available in a QFN 32-Lead package and, in a WLCSP 42-Ball package, as shown in Figure 1 and Figure 2, respectively.

Figure 1: NAU88L25B Block Diagram for 32-Lead QFN Package

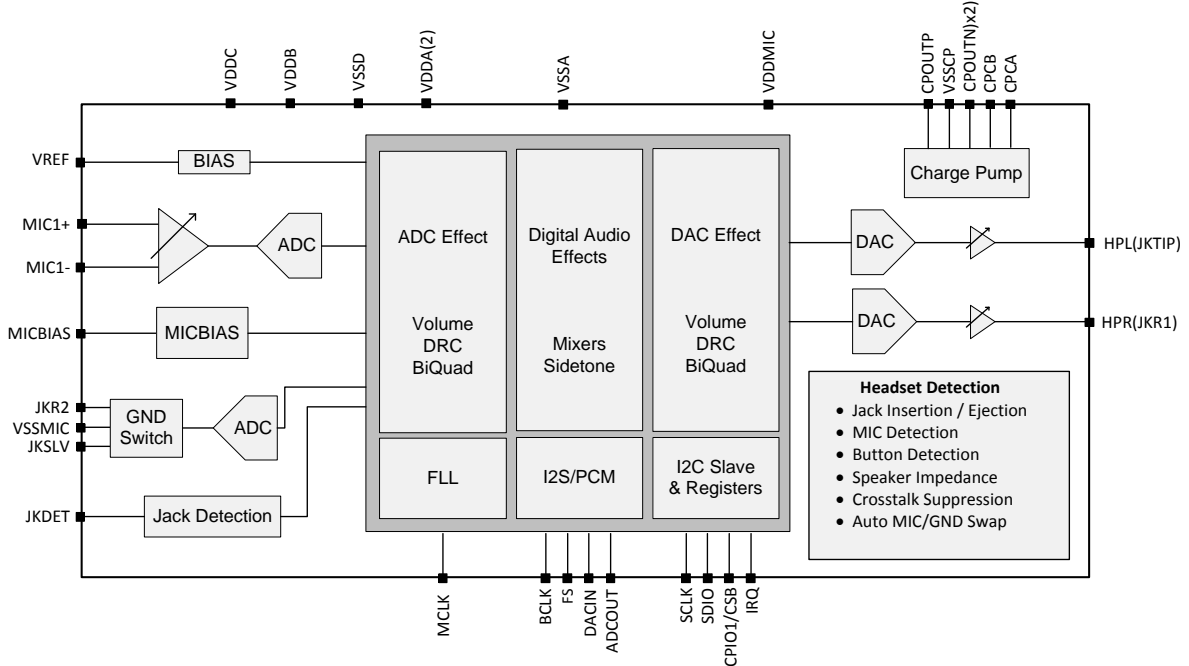
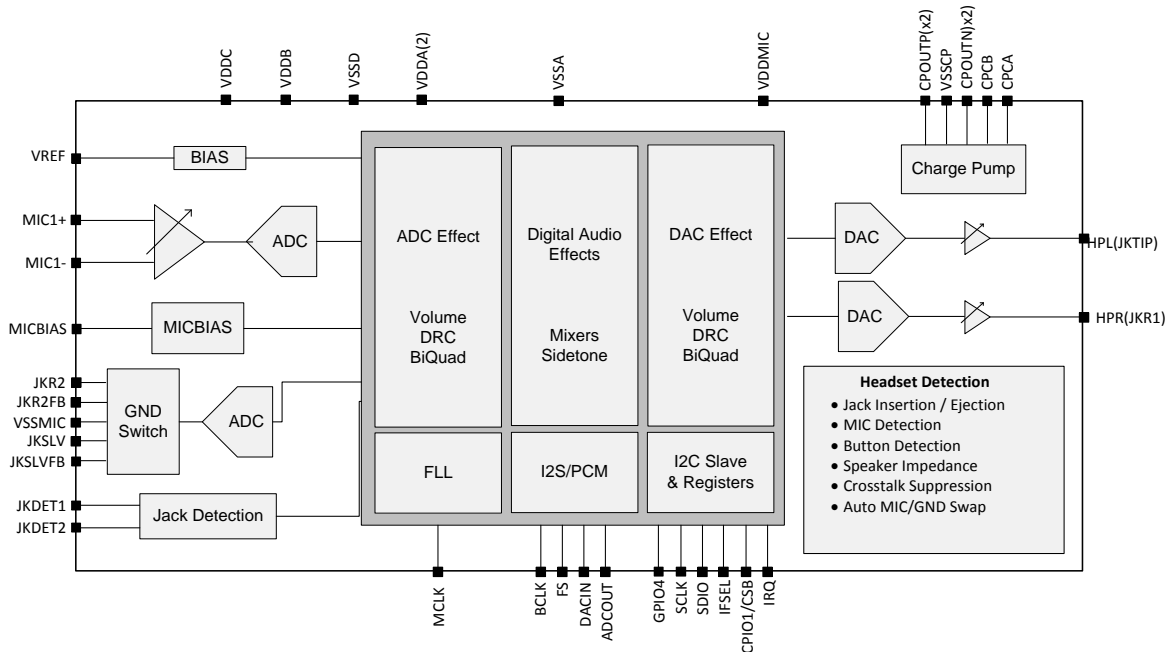

Figure 2: NAU88L25B Block Diagram for 42-Ball WLCSP Package



Pin Diagram

Figure 3 and 4 shows the pin diagram of QFN 32-Lead and WLCSP 42 ball package respectively.

Figure 3: NAU88L25B Pin Diagram for 32-Lead QFN Package

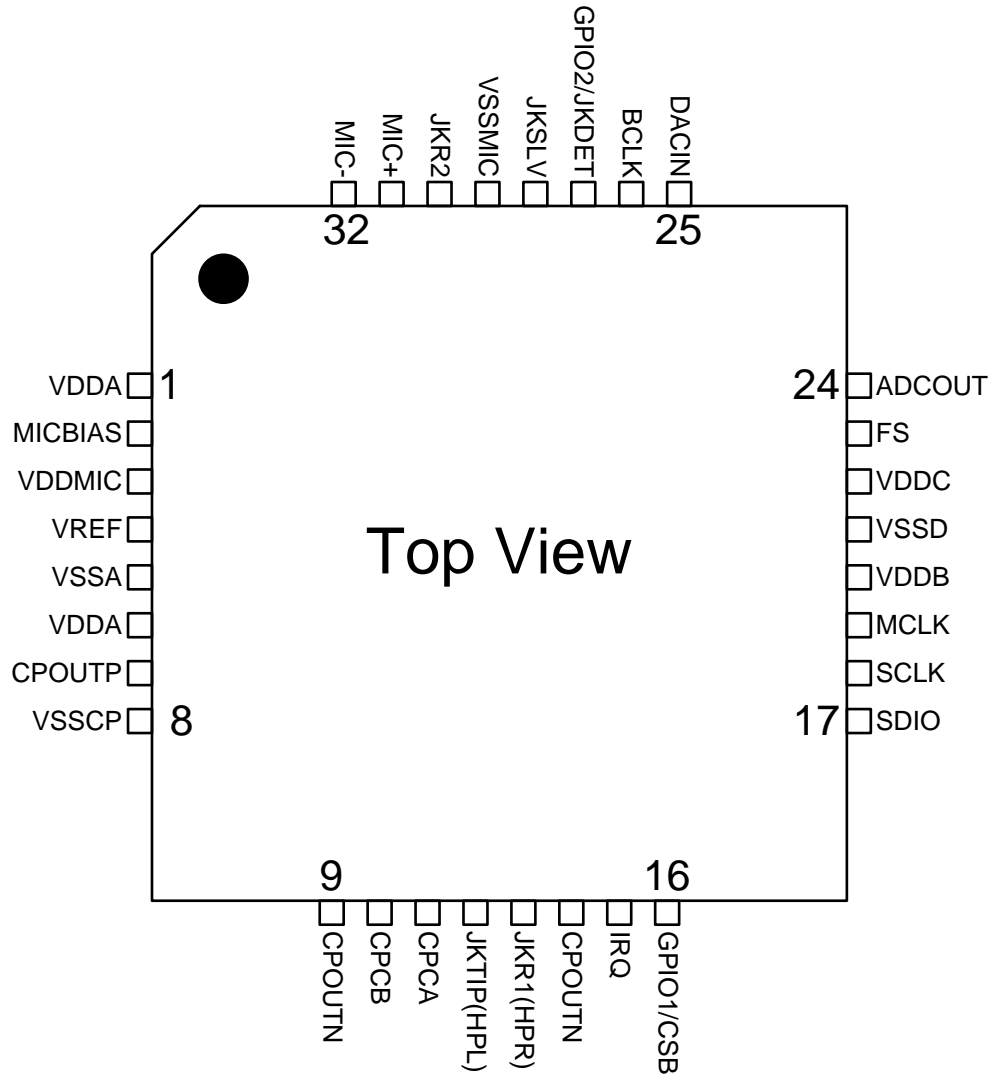
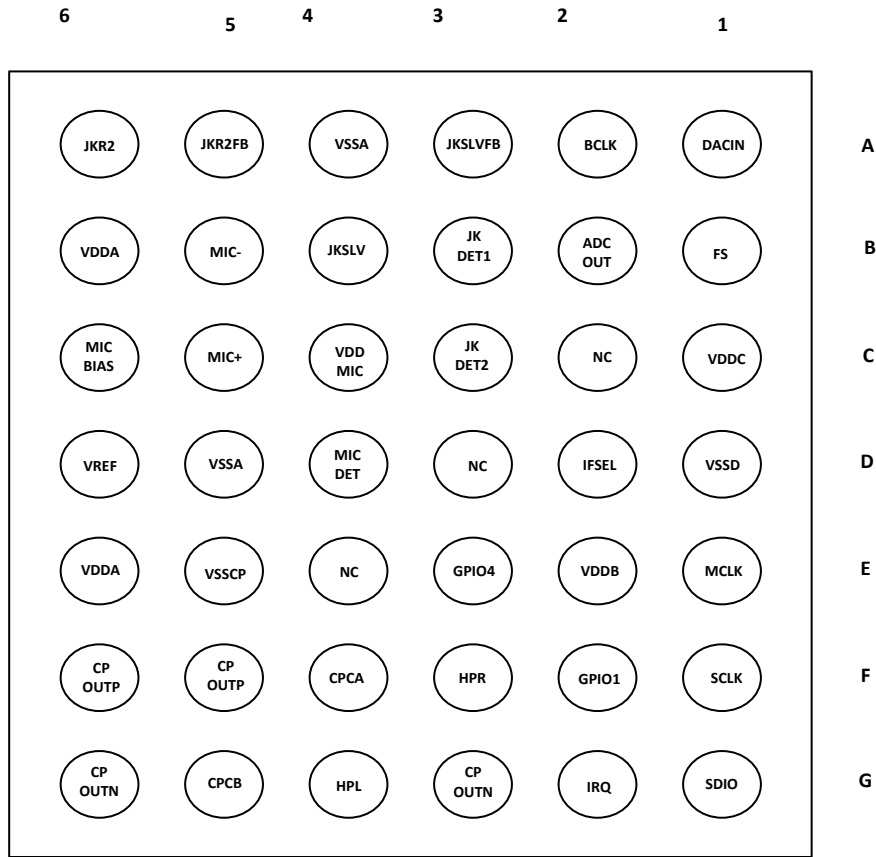

Figure 4: NAU88L25B Pin Diagram for 42-Ball WLCSP Package



Bottom View

Pin Descriptions

Pin Descriptions for the NAU88L25B are shown in **Table 1** and **Table 2** by package type.

Table 1 Pin Descriptions for 32-Lead QFN

Pin #	Name	Type	Functionality
1	VDDA	Supply	Analog Supply
2	MICBIAS	Analog Output	Microphone Bias Output
3	VDDMIC	Supply	Microphone Supply
4	VREF	Analog I/O	Internal DAC & ADC Voltage Reference Decoupling I/O
5	VSSA	Ground	Analog Supply Ground
6	VDDA	Supply	Analog Supply
7	CPOUTP	Analog I/O	Charge Pump Positive Voltage
8	VSSCP	Ground	Charge Pump Supply Ground
9	CPOUTN	Analog I/O	Charge Pump Negative Voltage
10	CPCB	Analog I/O	Charge Pump Switching Capacitor Node B
11	CPCA	Analog I/O	Charge Pump Switching Capacitor Node A
12	JKTIP(HPL)	Analog Output	Jack Tip; Headphone Left Channel Output
13	JKR1(HPR)	Analog Output	Jack Ring 1; Headphone Right Channel Output
14	CPOUTN	Analog I/O	Charge Pump Negative Voltage
15	IRQ	Digital Output	Programmable Interrupt Output
16	GPIO1	Digital I/O	General Purpose I/O/I2C Address
17	SDIO	Digital I/O	Serial Data for I2C
18	SCLK	Digital Input	Serial Data Clock for I2C
19	MCLK	Digital Input	CODEC Master Clock Input
20	VDDDB	Supply	Digital IO Supply
21	VSSD	Ground	Digital IO Ground
22	VDDC	Supply	Digital Core Supply
23	FS	Digital I/O	Frame Sync Input or Output for I2S or PCM Data
24	ADCOUT	Digital Output	Serial Audio Data Output for I2S or PCM Data
25	DACIN	Digital Input	Serial Audio Data Input for I2S or PCM Data
26	BCLK	Digital I/O	Serial Data Bit Clock Input or Output for I2S or PCM Data
27	JKDET	Analog Input	Jack Detect Input
28	JKSLV	Analog I/O	Jack Sleeve; Headset Jack Pin 4
29	VSSMIC	Ground	Analog Supply Ground
30	JKR2	Analog I/O	Jack Ring 2; Headset Jack Pin 3
31	MIC+	Analog Input	PGA MIC+ Analog Input
32	MIC-	Analog Input	PGA MIC- Analog Input

Table 2 Pin Descriptions 42-Ball WLCSP

Pin #	Name	Type	Functionality
A1	DACIN	Digital Input	Serial Audio Data Input for I2S or PCM Data
A2	BCLK	Digital I/O	Serial Data Bit Clock Input or Output for I2S or PCM Data
A3	JKSLVFB	Analog I	Jack Sleeve Feedback Sense Input
A4	VSSA	Ground	Analog Supply Ground
A5	JKR2FB	Analog I	JackRing 2 Feedback Sense Input
A6	JKR2	Analog I/O	JackRing 2 Jack Terminal
B1	FS	Digital I/O	Frame Sync Input or Output for I2S or PCM Data
B2	ADCOUT	Digital Output	Serial Audio Data Output for I2S or PCM Data
B3	JKDET1	Analog Input	Jack Detect Input
B4	JKSLV	Analog I/O	Jack Sleeve Jack Terminal
B5	MIC-	Analog Input	PGA MIC- Analog Input
B6	VDDA	Supply	Analog Supply
C1	VDDC	Supply	Digital Core Supply
C2	NC	No Connect	This pin should remain not connected
C3	JKDET2	Analog Input	Jack Detect Input
C4	VDDMIC	Supply	Microphone Supply
C5	MIC+	Analog Input	PGA MIC+ Analog Input
C6	MICBIAS	Analog Output	Microphone Bias Output
D1	VSSD	Ground	Analog Supply Ground
D2	IFSEL	Digital Input	I2C/SPI Interface selection
D3	NC	No Connect	This pin should remain not connected
D4	MICDET	Analog I/O	Microphone Signal and SAR ADC Input
D5	VSSA	Ground	Analog Supply Ground
D6	VREF	Analog I/O	Internal DAC & ADC Voltage Reference Decoupling I/O
E1	MCLK	Digital Input	CODEC Master Clock Input
E2	VDDDB	Supply	Digital IO Supply
E3	GPIO4	Digital Output	Serial Data Output for SPI Data
E4	NC	No Connect	This pin should remain NOT CONNECTED
E5	VSSCP	Ground	Charge Pump Supply Ground
E6	VDDA	Supply	Analog Supply
F1	SCLK	Digital Input	Serial Data Clock for I2C
F2	GPIO1	Digital I/O	General Purpose Input Output/I2C Address
F3	JKR1(HPR)	Analog Output	Jack Ring 1; Headphone Right Channel Output
F4	CPCA	Analog I/O	Charge Pump Switching Capacitor Node A
F5	CPOUTP	Analog I/O	Charge Pump Positive Voltage
F6	CPOUTP	Analog I/O	Charge Pump Positive Voltage
G1	SDIO	Digital I/O	Serial Data for I2C

Pin #	Name	Type	Functionality
G2	IRQ	Digital Output	Programmable Interrupt Output
G3	CPOUTN	Analog I/O	Charge Pump Negative Voltage
G4	JKTIP(HPL)	Analog Output	Jack Tip; Headphone left channel output
G5	CPCB	Analog I/O	Charge Pump Switching Capacitor Node B
G6	CPOUTN	Analog I/O	Charge Pump Negative Voltage

Note: Analog I/O supply is VDDA; Digital I/O supply is VDDB.

Electrical Characteristics

Absolute Maximum Ratings

Table 3 provides the absolute maximum ratings for the NAU88L25B Audio CODEC.

CAUTION: Do not operate at or near maximum ratings extended periods. Stresses above those listed in Table 3 may cause permanent damage to the device. Exposure to conditions beyond these ratings may adversely affect the life and reliability of the device and result in failures not covered by warranty.

Table 3 Absolute Maximum Ratings

Parameter	Min	Max	Units
Junction Temperature, T _J	-40	+150	°C
Storage Temperature	-65	+150	°C
Analog Supply Range	-0.3	2.2	V
Digital I/O Supply Range	-0.3	6.0	V
Digital Supply Range	-0.3	2.2	V
Input Voltage Digital Range	DGND - 0.3	VDD + 0.3	V
Input Voltage Analog Range	AGND - 0.3	VDD + 0.3	V
Headphone Supply Range	-0.3	2.2	V
Microphone Bias Supply Voltage	-0.3	6.0	V

Operating Conditions

Table 4 provides the recommended operating conditions for the NAU88L25B.

Table 4 Operating Conditions

Condition	Symbol	Min	Typical	Max	Units
Analog Supply Range	VDDA	1.6	1.8	2.0	V
Digital Supply Range	VDDC	1.1	1.2	1.98	V
Digital Supply Range for FLL Operation and for F _s > 48 KHz	VDDC	1.61	1.8	1.98	V
Digital I/O Supply Range	Vddb	1.6	1.8	3.6	V
Headphone Supply Range	VDDA	1.6	1.8	2.0	V
Microphone Bias Supply Voltage	VDDMIC	2.5	4.2	5.0	V
Temperature Range	TA	-40		+85	°C
QFN Package	Junction to Ambient	η_{ja}°	33.1		°C/W
	Junction to Case	η_{jc}°	3.1		°C/W

Shutdown and Standby Current

Table 5 provides Shutdown and Standby currents.

Table 5 Shutdown and Standby Current

Parameter	Symbol	Conditions	Typical	Limit	Units
Shutdown Current	ISD	VDDA in Shutdown Mode	0.2	1	μA
		VDDA When VDDC=1.2 V	17.2		
		VDDB	0.2	1	
		VDDC	2	10	
		VDDMIC	0.2	1	
Standby Current	IDD	MCLK off, Jack Insertion, IRQ enabled	5		μA

ADC Characteristics

Table 6 provides the ADC electrical characteristics for the NAU88L25B Audio CODEC.

Conditions: VDDA = VDDB = VDDC = 1.8 V; VDDMIC= 4.2 V. RL(Headphone) = 32 Ω, f = 1 kHz, MCLK=12.88 MHz, unless otherwise specified. Limits apply for TA = 25° C.

Table 6 ADC Electrical Characteristics

Parameter	Symbol	Conditions	Typical	Limit	Units
ADC Total Harmonic Distortion + Noise	THD+N	MIC Input, MIC_GAIN = 0 dB, VIN = 0.8 Vrms, f = 1 KHz, fs = 48 KHz, Mono Differential Input	-91		dB
		MIC Input, MIC_GAIN = 30 dB, Volume = 0 dB, VIN = 28.5 Vrms, fs = 1 k, Digital Gain = 0 dB, Mono Differential Input	-80		dB
Signal-to-Noise Ratio	SNR	Reference = VOUT(0dBFS), A-Weighted, MIC Input, MIC Gain = 0 dB, fs = 8 KHz, Mono Differential Input	101		dB
		Reference = VOUT(0 dB FS), A-Weighted, MIC Input, MIC Gain = 6 dB, fs = 8 KHz, Mono Differential Input	98		dB
Power Supply Rejection Ratio	PSRR	V _{RIPPLE} = 200 mV _{PP} applied to VDDA, f _{RIPPLE} = 217 Hz, Input Referred, MIC_GAIN = 0 dB Differential Input	78		dB
Common Mode Rejection Ratio	CMRR	Differential Input 100 Vrms, PGA Gain = 20 dB, frequency sweep from 20 Hz to 20 KHz	64		dB
ADC Full Scale Input Level	FSADC	VDDA= 1.8 V	1		V _{RMS}
Minimum Input Impedance			12		KOhm

Parameter	Symbol	Conditions	Typical	Limit	Units
Frequency Response		f = 20 Hz ~ 20 KHz	+/-0.02		dB
Power Consumption		No Load, No Signal, ADC on, PGA on; fs = 44.1 kHz	5.4		mW

Headphone Amplifier Characteristics

Table 7 provides the headphone amplifier electrical characteristics for the NAU88L25B.

Conditions: VDDA = VDDDB = VDDC = 1.8 V; VDDMIC= 4.2 V. RL(Headphone) = 32 Ω, f = 1 kHz, MCLK=12.88 MHz, unless otherwise specified. Limits apply for TA = 25° C.

Table 7 Headphone Amplifier Electrical Characteristics

Parameter	Symbol	Conditions	Typical	Limit	Units
Output Power 32-Lead QFN Package	PO	Stereo RL = 16 Ω, DAC Input, CPVDD = 1.8 V, f = 1 kHz, 22 kHz BW, THD+N = 1% w. Headset Switch	35		mW
		Stereo RL = 32 Ω, DAC Input, CPVDD = 1.8 V, f = 1 kHz, 22 kHz BW, THD+N = 1%, w. Headset Switch	28		mW
Output Power 42-Ball WLCSP Package		Stereo RL = 16Ω, DAC Input, CPVDD = 1.8 V, f = 1 kHz, 22 kHz BW, THD+N = 1%, w. Headset Switch	39.5		mW
		Stereo RL = 32 Ω, DAC Input, CPVDD = 1.8 V, f = 1 kHz, 22 kHz BW, THD+N = 1%, w. Headset Switch	30.5		mW
Total Harmonic Distortion + Noise	THD+N	RL = 32 Ω, f=1 kHz, PO = 20 mW, w. Headset Switch	-89		dB
Signal to Noise Ratio	SNR	VOUT = 1 VRMS, DAC Input, DAC_Gain = 0 dB, HP_Gain = 0 dB, Digital Zero Input, f = 1 kHz, A-Weighted, w. Headset Switch	113		dB
		VOUT = 1 VRMS, DAC Input, DAC_Gain = 0 dB, HP_Gain = 0 dB, Digital Zero Input, f = 1 kHz, A-Weighted, Auto Mute Enabled, w. Headset Switch	124		dB

Parameter	Symbol	Conditions	Typical	Limit	Units
Power Supply Rejection Ratio	PSRR	f _{RIPPLE} = 217 Hz, V _{RIPPLE} = 200 mV _{P-P} Input Referred, HP_GAIN = 0 dB DAC Input, DAC_Gain = 0 dB Ripple Applied to VDDA	81		dB
Channel Crosstalk	X _{TALK}	Left Channel to Right Channel, -1 dB FS, Gain = 0 dB, f = 1 kHz, MIC/GND Switching Off without HCS	88		dB
		Left Channel to Right Channel, -1 dB FS, Gain = 0 dB, f = 1 kHz, MIC/GND Switching On with HCS (QFN)	91		dB
		Left Channel to Right Channel, -1 dB FS, Gain = 0 dB, f = 1 kHz, MIC/GND Switching On with HCS (WLCSP)	98		dB
Interchannel Level Mismatch		Headphone Right and Left Channel Difference with 0 dB FS Input Sweep from 20 Hz to 20 KHz	+/- 0.1		dB
Frequency Response		F = 20 Hz ~ 20 KHz	+/-0.005		dB
Output Noise	e _{OS}	DAC_Gain = 0 dB, HP_Gain = 0 dB, f _S =48 kHz, OSRDAC = 128, A-Weighted	2.2		μV _{RMS}
Out-of-Band Noise Level		BW= 400 Hz to 500 KHz	-86		dB
Output Offset Voltage	VOS	HP_Gain = 0 dB, DAC_Gain= 0 dB, DAC Input	0.1	±0.5	mV
Power Consumption		No Load, No Signal, Amp on f _S = 48 kHz, Stereo DAC On, Amp On, POUT = 0 mW. R _L = 32 Ω	5.7		mW
Pop-and-Click Noise		Into or out of DAC to Headphone Shutdown, Headphone Impedance & Crosstalk Detection Disabled	.1		mVrms
Ground Switch ON Resistance		ON Resistance between JKR2 and GND or JKSLV and GND (QFN)	.09		Ohm
		ON Resistance between JKR2 and GND or JKSLV and GND (WLCSP)	0.075		Ohm

Digital I/O Characteristics

Table 8 provides the headphone amplifier electrical characteristics for the NAU88L25B.

Conditions: $V_{DDA} = V_{DDB} = V_{DDC} = 1.8\text{ V}$; $V_{DDMIC} = 4.2\text{ V}$. $R_L(\text{Headphone}) = 32\ \Omega$, $f = 1\text{ kHz}$, $MCLK = 12.88\text{ MHz}$, unless otherwise specified. Limits apply for $T_A = 25^\circ\text{ C}$.

Table 8 Digital I/O Characteristics

Parameter	Symbol	Comments/Conditions	Min	Max	Units
Input LOW Level	VIL	V _{DDB} = 1.8 V		0.33* V _{DDB}	V
		V _{DDB} = 3.3 V		0.37**V _{DDB}	
Input HIGH Level	VIH	V _{DDB} = 1.8 V	0.67* V _{DDB}		V
		V _{DDB} = 3.3 V	0.63* V _{DDB}		
Output HIGH Level	VOH	I _{Load} = 1mA	V _{DDB} = 1.8 V	0.9* V _{DDB}	V
			V _{DDB} = 3.3 V	0.95* V _{DDB}	
Output LOW Level	VOL	I _{Load} = 1mA	V _{DDB} = 1.8 V	0.1* V _{DDB}	V
			V _{DDB} = 3.3 V	0.05* V _{DDB}	

Ordering Information

Table 9 provides dimensions and packaging information for the NAU88L25B Audio CODECs.

Table 9 Ordering Information

Part Number	Dimension	Package	Package Material
NAU88L25YGB	5 x 5 mm	QFN-32 Lead	Green
NAU88L25VGB	2.552 x 2.915 mm	WLCSP 42-Balls	Green

NAU88L25 = Part Name

L = Low-Power Product

Lead-Free (Green) Packaging:

YG = indicates QFN packaging

VG = indicates WLCSP packaging WLCSP

B = Chip Revision

Package Information

QFN 32-Lead Package

QFN32L 5X5 mm², Thickness 0.8 mm (Max) , Pitch 0.5 mm (Saw Type) EP SIZE 3.5 X 3.5 mm.

Figure 5 QFN 32-Lead Package

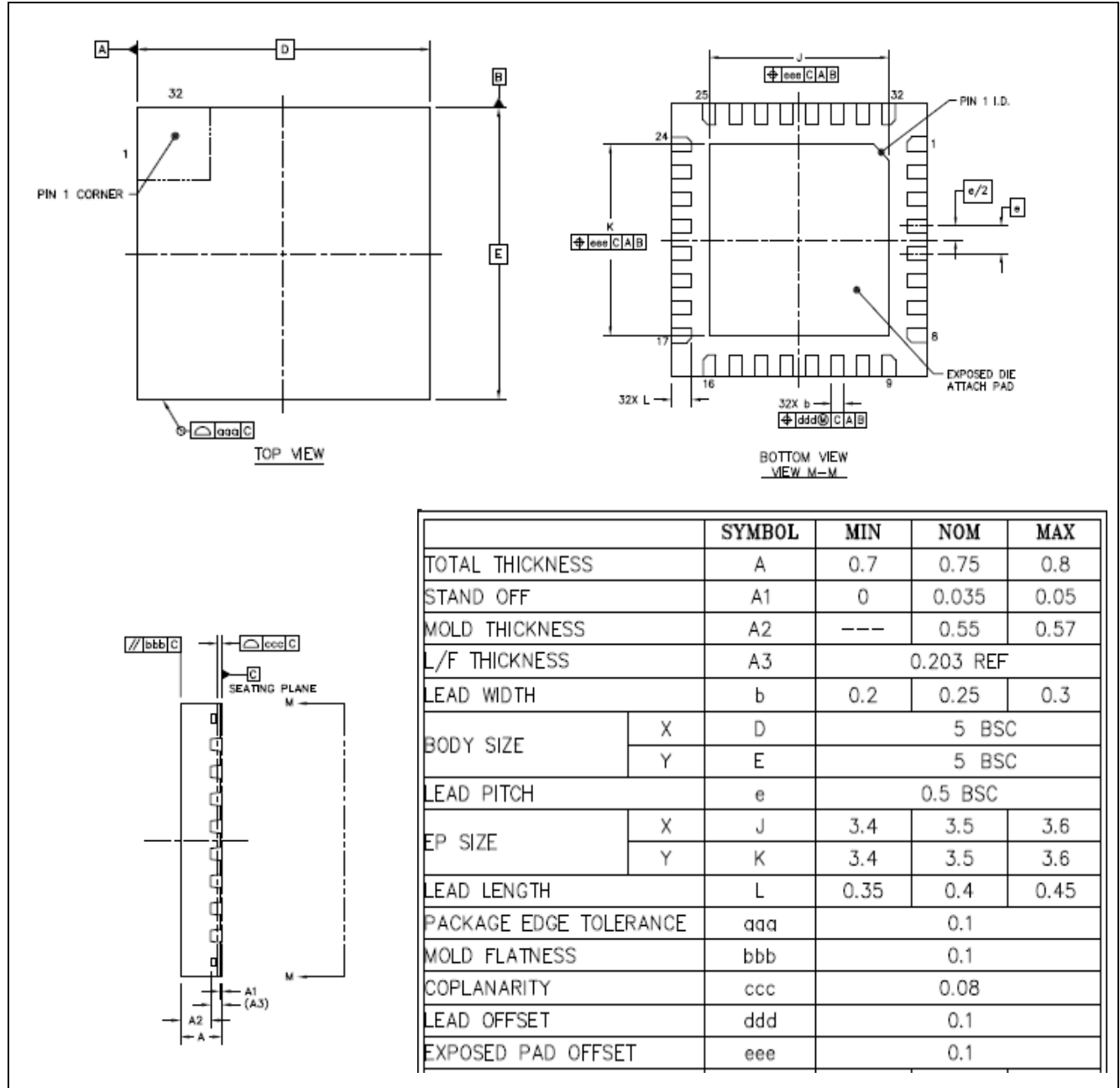

WLCSP 42-Ball Package

WLCSP 42-Balls package, 2.552 x 2.915 mm, with 0.4 mm Pitch.

Figure 6 WLCSP 42-Ball Package

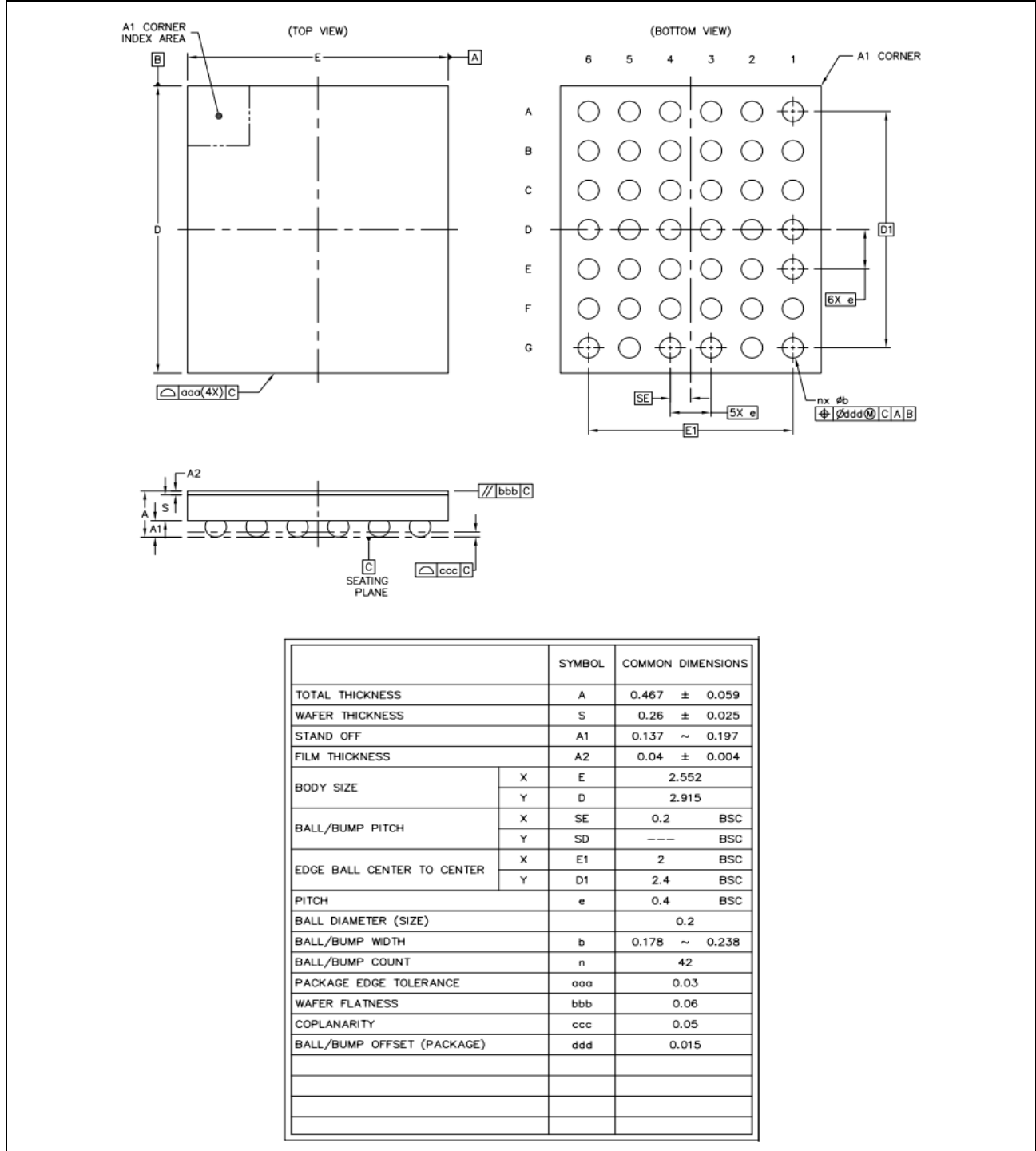

Revision History

Table 10: Revision History

Version			Description
#	Date	Page(s)	
0.1	Nov 20, 2014	NA	Preliminary Version
0.2	Mar 10, 2015		Updated the pin-out and pin-descriptions
0.3	Apr 10, 2015	8	Ordering info is added.
0.4	Jun 15, 2015	5, 6	Updated Electrical Characteristics
0.5	July 16, 2015	1	Updated the descriptions
0.6	Sep 28, 2015	1, 2, 7, 8	Updated the descriptions and key features Updated the block diagram Changed VIH (input high voltage) Updated the package information
0.7	Oct 27, 2015	9	Updated the package info
1.0	Aug 19, 2016	All	Content format changes, edits for grammar and clarity. Color removed from graphics.



Important Notice

Nuvoton products are not designed, intended, authorized or warranted for use as components in systems or equipment intended for surgical implantation, atomic energy control instruments, airplane or spaceship instruments, transportation instruments, traffic signal instruments, combustion control instruments, or for other applications intended to support or sustain life. Furthermore, Nuvoton products are not intended for applications wherein failure of Nuvoton products could result or lead to a situation wherein personal injury, death or severe property or environmental damage could occur.

Nuvoton customers using or selling these products for use in such applications do so at their own risk and agree to fully indemnify Nuvoton for any damages resulting from such improper use or sales.

Looking for pricing, stock, or lifecycle information?

Click below to explore more details on WIN SOURCE:

-  [View NAU88L25YGB on WIN SOURCE](#)
-  [Nuvoton Technology Corporation of America Information](#)

Optimize Your Supply Chain with WIN SOURCE Solutions

-  Global Sourcing Solution
-  Obsolete Management
-  Cost Control Management
-  Shortage Management
-  Alternative Solution
-  Excess Inventory Management