



THE DATASHEET OF PAX2A000



PAX2A - 1/8 DIN Analog Input Panel Meter Installation Guide



See the Red Lion website at www.redlion.net or the enclosed USB thumbdrive for a complete user manual.

SPECIFICATIONS

POWER:

AC Power: 40 to 250 VAC, 50/60 Hz, 20 VA
 DC Power: 21.6 to 250 VDC, 8 W
 Isolation: 2300 Vrms for 1 min. to all inputs and outputs.

INPUT CAPABILITIES:

Current Input Ranges:
 ± 250 µADC ± 2.5 mADC ± 25 mADC
 ± 250 mADC ± 2 ADC

Voltage Input Ranges:
 ± 250 mVDC ± 2.0 VDC ± 10 VDC
 ± 25 VDC ± 100 VDC ± 200 VDC

Thermocouple Inputs:

Types: T, E, J, K, R, S, B, N, C (W5/W26)
 Max Continuous Overvoltage: 30 V

RTD Inputs:

Type: 3 or 4 wire, 2 wire can be compensated for lead wire resistance
 Excitation current: 100 ohm range: 136.5 µA ±10%
 10 ohm range: 2.05 mA ±10%
 Max. continuous overload: 30 VDC
 Input Type:
 100 ohm Pt alpha = .00385 100 ohm Pt alpha = .00392
 120 ohm Nickel alpha = .00672 10 ohm Copper alpha = .00427

Resistance Inputs:

Max. continuous overload: 30 VDC

INPUT RANGE	COMPLIANCE
100 ohm	0.175 V
999 ohm	1.75 V
9999 ohm	17.5 V

EXCITATION POWER:

Jumper selectable
 Transmitter Power: +18 VDC, ± 5% @ 50 mA max.
 Reference Voltage: + 2 VDC, ± 2%
 Compliance: 1KΩ load min (2 mA max)
 Temperature Coefficient: 40 ppm/°C max.
 Reference Current: 1.05 mADC, ± 2%
 Compliance: 10 KΩ load max

USER INPUTS:

Two programmable user inputs
 Max. Continuous Input: 30 VDC
 Isolation To Sensor Input Common: Not isolated.

ENVIRONMENTAL CONDITIONS:

Operating Temperature Range: 0 to 50 °C
 Storage Temperature Range: -40 to 60 °C
 Vibration to IEC 68-2-6: Operational 5-150 Hz, 2 g
 Shock to IEC 68-2-27: Operational 25 g (10 g relay)
 Operating and Storage Humidity: 0 to 85% max. RH non-condensing
 Altitude: Up to 2000 meters

CERTIFICATIONS AND COMPLIANCES:

CE Approved

EN 61326-1 Immunity to Industrial Locations
 Emission CISPR 11 Class A
 IEC/EN 61010-1
 RoHS Compliant

UL Listed: File #E179259

Type 4X Indoor Enclosure rating (Face only)
 IP65 Enclosure rating (Face only)
 IP20 Enclosure rating (Rear of unit)

CONNECTIONS:

High compression cage-clamp terminal block
 Wire Strip Length: 0.3" (7.5 mm)
 Wire Gauge Capacity: One 14 AWG (2.55 mm) solid,
 two 18 AWG (1.02 mm) or four 20 AWG (0.61 mm)

CONSTRUCTION:

This unit is rated NEMA 4X/IP65 for indoor use only.
 IP20 Touch safe. Installation Category II, Pollution Degree 2. One
 piece bezel/ case. Flame resistant. Synthetic rubber keypad. Panel
 gasket and mounting clip included.

WEIGHT: 8 oz. (226.8 g)

DIMENSIONS In inches (mm)

Note: Recommended minimum clearance (behind the panel) for mounting clip installation is 2.1" (53.4) H x 5.5" (140) W.

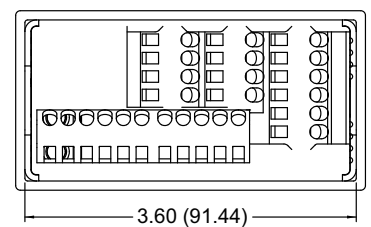
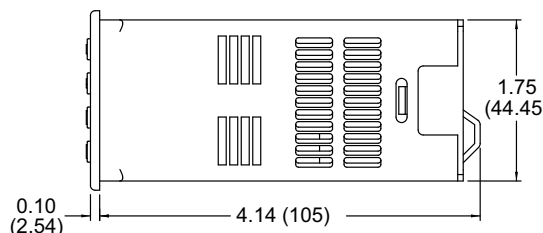
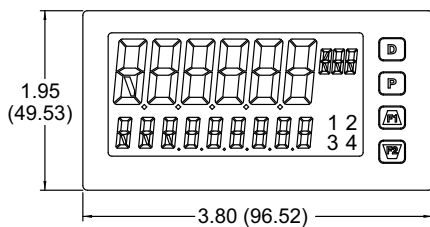

SAFETY SUMMARY

All safety related regulations, local codes and instructions that appear in this literature or on equipment must be observed to ensure personal safety and to prevent damage to either the instrument or equipment connected to it. If equipment is used in a manner not specified by the manufacturer, the protection provided by the equipment may be impaired. Do not use this unit to directly command motors, valves, or other actuators not equipped with safeguards. To do so can be potentially harmful to persons or equipment in the event of a fault to the unit.



CAUTION: Risk Of Danger.
Read complete instructions prior to installation and operation of the unit.



CAUTION: Risk of electric shock.

METER INSTALLATION

The PAX2A meets NEMA 4X/IP65 requirements when properly installed. The unit is intended to be mounted into an enclosed panel. Prepare the panel cutout to the dimensions shown. Remove the panel latch from the unit. Slide the panel gasket over the rear of the unit to the back of the bezel. The unit should be installed fully assembled. Insert the unit into the panel cutout.

While holding the unit in place, push the panel latch over the rear of the unit so that the tabs of the panel latch engage in the slots on the case. The panel latch should be engaged in the farthest forward slot possible. To achieve a proper seal, tighten the latch screws evenly until the unit is snug in the panel (Torque to approximately 7 in-lbs [79N-cm]). Do not over-tighten the screws.

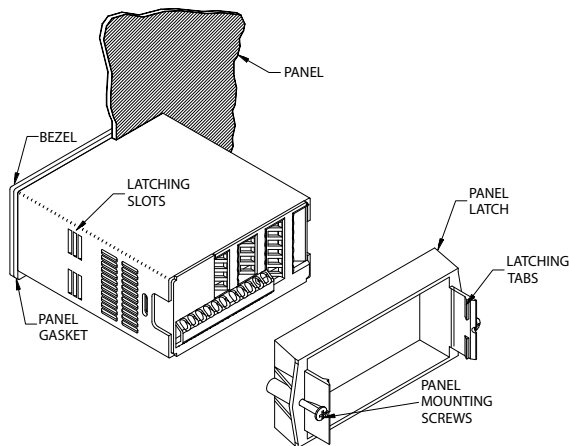

INSTALLATION ENVIRONMENT

The unit should be installed in a location that does not exceed the operating temperature and provides good air circulation. Placing the unit near devices that generate excessive heat should be avoided.

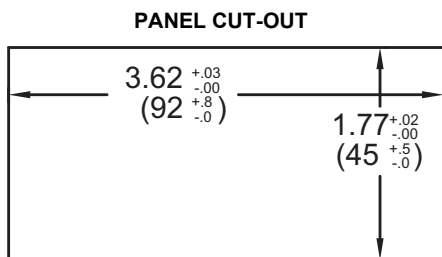

SETTING THE JUMPERS

The PAX2A controller has four jumpers that must be checked and/or changed prior to applying power. The following Jumper Selection Figures show an enlargement of the jumper area.

To access the jumpers, remove the meter base from the case by firmly squeezing and pulling back on the side rear finger tabs. This should lower the latch below the case slot (which is located just in front of the finger tabs). It is recommended to release the latch on one side, then start the other side latch.



Warning: Exposed line voltage exists on the circuit boards. Remove all power to the meter and load circuits before accessing inside of the meter.

INPUT RANGE JUMPERS

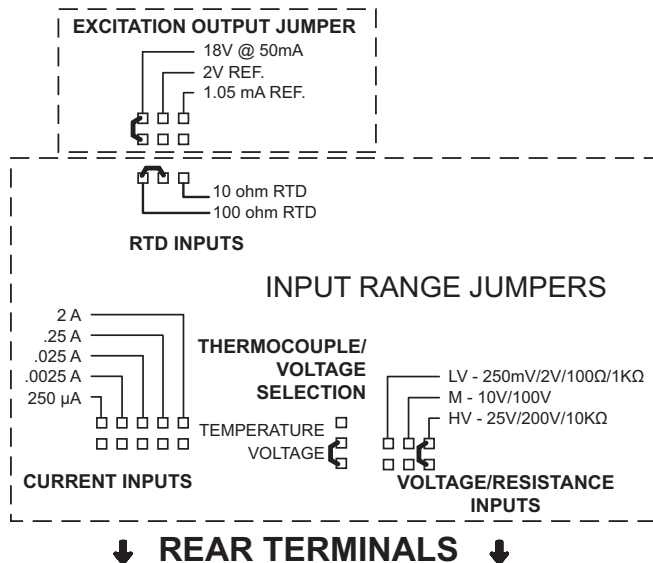
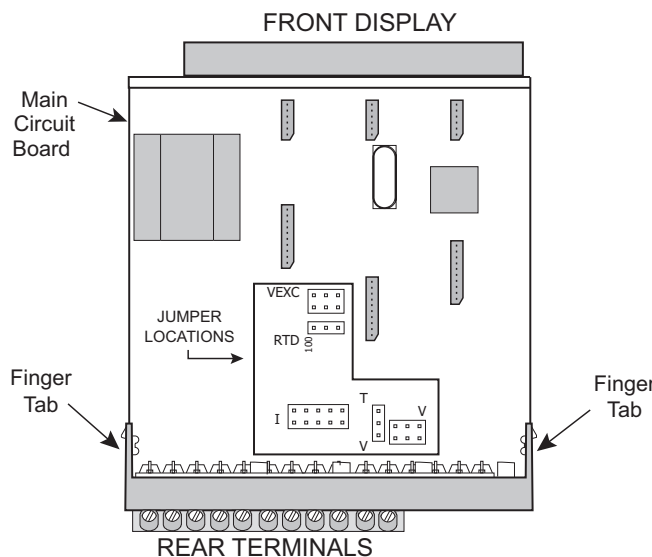

POWER WIRING

The power supplied to the meter shall employ a 15 Amp UL approved circuit breaker for AC input and a 1 Amp, 250 V UL approved fuse for DC input. It shall be easily accessible and marked as a disconnecting device to the installed unit. This device is not directly intended for connection to the mains without a reliable means to reduce transient over-voltages to 1500 V.

AC Power



DC Power

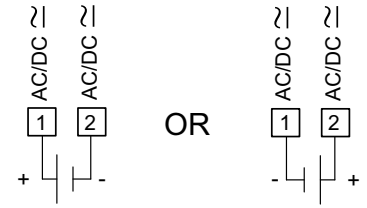

VOLTAGE/RESISTANCE/CURRENT INPUT SIGNAL WIRING

IMPORTANT: Before connecting signal wires, the Input Range Jumpers and Excitation Jumper should be verified for proper position.

Voltage Signal

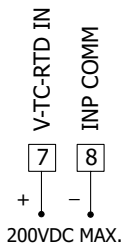

Process/Current Signal (external powered)

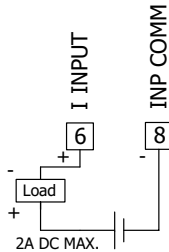

Process/Current Signal (2 wire requiring 18 V excitation)

Excitation Jumper: 18 V

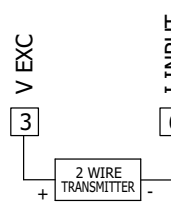

Current Signal (3 wire requiring 18 V excitation)

Terminal 3: +Volt supply
Terminal 6: +ADC (signal)
Terminal 8: -ADC (common)
Excitation Jumper: 18 V

Voltage Signal (3 wire requiring 18 V excitation)

Terminal 3: +Volt supply
Terminal 7: +VDC (signal)
Terminal 8: -VDC (common)
Excitation Jumper: 18 V

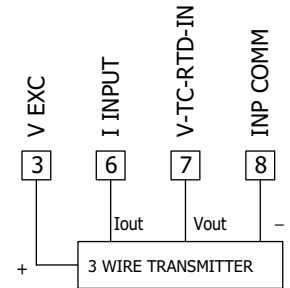

Resistance Signal (2 wire requiring excitation)

Terminal 3: Jumper to terminal 7
Terminal 7: Resistance
Terminal 8: Resistance
Excitation Jumper: 1.05 mA REF
T/V Jumper: V position
Voltage/Resistance Input Jumper: Set per input signal

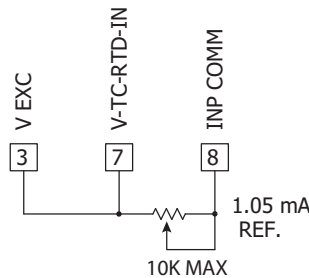

Potentiometer Signal as Voltage Input (3 wire requiring excitation)

Terminal 3: High end of pot.
Terminal 7: Wiper
Terminal 8: Low end of pot.
Excitation Jumper: 2 V REF.
T/V Jumper: V
Voltage/Resistance Input Jumper: 2 Volt
Module 1 Input Range: 2 Volt
Note: The Apply signal scaling style should be used because the signal will be in volts.

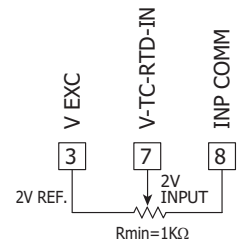

CAUTION: Sensor input common is NOT isolated from user input common. In order to preserve the safety of the controller application, the sensor input common must be suitably isolated from hazardous live earth referenced voltages; or input common must be at protective earth ground potential. If not, hazardous live voltage may be present at the User Inputs and User Input Common terminals. Appropriate considerations must then be given to the potential of the user input common with respect to earth common; and the common of the isolated plug-in cards with respect to input common.

TEMPERATURE INPUT SIGNAL WIRING

IMPORTANT: Before connecting signal wires, verify the T/V Jumper is in the T position.

Thermocouple



3-Wire RTD

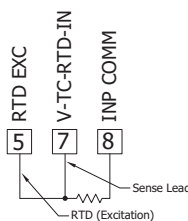

2-Wire RTD

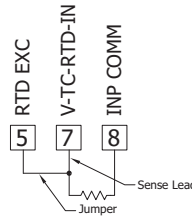

CAUTION: Sensor input common is NOT isolated from user input common. In order to preserve the safety of the controller application, the sensor input common must be suitably isolated from hazardous live earth referenced voltages; or input common must be at protective earth ground potential. If not, hazardous live voltage may be present at the User Inputs and User Input Common terminals. Appropriate considerations must then be given to the potential of the user input common with respect to earth common; and the common of the isolated plug-in cards with respect to input common.

USER INPUT WIRING

If not using User Inputs, then skip this section. User Input terminal does not need to be wired in order to remain in the inactive state.

Sinking Logic

(UAE L₀)

When the UAE parameter is programmed to L₀, the user inputs of the controller are internally pulled up to +3.3 V with 20 KΩ resistance. The input is active when it is pulled low (<1.1 V).

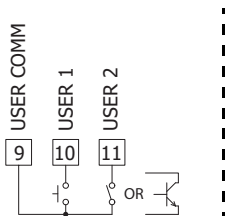

Sourcing Logic

(UAE H₁)

When the UAE parameter is programmed to H₁, the user inputs of the controller are internally pulled down to 0 V with 20 KΩ resistance. The input is active when a voltage greater than 2.2 VDC is applied.

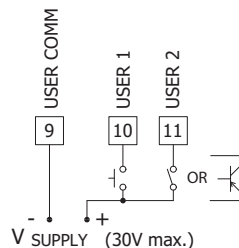

SETPOINT (ALARMS) WIRING SERIAL COMMUNICATION WIRING ANALOG OUTPUT WIRING

See appropriate option card bulletin for details.

ORDERING INFORMATION

DESCRIPTION	PART NUMBER
Universal DC Analog Input Panel Meter	PAX2A000
Dual Setpoint Relay Output Card	PAXCDS10
Quad Setpoint Relay Output Card	PAXCDS20
Quad Setpoint Sinking Open Collector Output Card	PAXCDS30
Quad Setpoint Sourcing Open Collector Output Card	PAXCDS40
Dual Triac/Dual SSR Drive Digital Output Card	PAXCDS50
Quad Form C Relay Digital Output Card	PAXCDS60 *
RS485 Serial Communications Card with Terminal Block	PAXCDC10
Extended RS485 Serial Communications Card with Dual RJ11 Connector	PAXCDC1C
RS232 Serial Communications Card with Terminal Block	PAXCDC20
Extended RS232 Serial Communications Card with 9 Pin D Connector	PAXCDC2C
DeviceNet Communications Card	PAXCDC30
Profibus-DP Communications Card	PAXCDC50
Analog Output Card	PAXCDL10

* This card is not suitable for use in older PAX2A models. For proper installation, 3 case knock-out features must be present on the top case surface (horizontal controller) or right case surface (vertical controller). To update a case to include these knock-outs, a replacement case is available. RCPX2H00 = Horizontal replacement case, RCPX2V00 = Vertical replacement case.

LIMITED WARRANTY

(a) Red Lion Controls Inc., (the "Company") warrants that all Products shall be free from defects in material and workmanship under normal use for the period of time provided in "Statement of Warranty Periods" (available at www.redlion.net) current at the time of shipment of the Products (the "Warranty Period"). **EXCEPT FOR THE ABOVE- STATED WARRANTY, COMPANY MAKES NO WARRANTY WHATSOEVER WITH RESPECT TO THE PRODUCTS, INCLUDING ANY (A) WARRANTY OF MERCHANTABILITY; (B) WARRANTY OF FITNESS FOR A PARTICULAR PURPOSE; OR (C) WARRANTY AGAINST INFRINGEMENT OF INTELLECTUAL PROPERTY RIGHTS OF A THIRD PARTY; WHETHER EXPRESS OR IMPLIED BY LAW, COURSE OF DEALING, COURSE OF PERFORMANCE, USAGE OF TRADE OR OTHERWISE.** Customer shall be responsible for determining that a Product is suitable for Customer's use and that such use complies with any applicable local, state or federal law.

(b) The Company shall not be liable for a breach of the warranty set forth in paragraph (a) if (i) the defect is a result of Customer's failure to store, install, commission or maintain the Product according to specifications; (ii) Customer alters or repairs such Product without the prior written consent of Company.

(c) Subject to paragraph (b), with respect to any such Product during the Warranty Period, Company shall, in its sole discretion, either (i) repair or replace the Product; or (ii) credit or refund the price of Product provided that, if Company so requests, Customer shall, at Company's expense, return such Product to Company.

(d) **THE REMEDIES SET FORTH IN PARAGRAPH (c) SHALL BE THE CUSTOMER'S SOLE AND EXCLUSIVE REMEDY AND COMPANY'S ENTIRE LIABILITY FOR ANY BREACH OF THE LIMITED WARRANTY SET FORTH IN PARAGRAPH (a).**

Looking for pricing, stock, or lifecycle information?

Click below to explore more details on WIN SOURCE:

 [View PAX2A000 on WIN SOURCE](#)

 [Red Lion Controls Information](#)

Optimize Your Supply Chain with WIN SOURCE Solutions

-  Global Sourcing Solution
-  Obsolete Management
-  Cost Control Management
-  Shortage Management
-  Alternative Solution
-  Excess Inventory Management