



**THE DATASHEET OF  
REF191GS-REEL**



### FEATURES

- Temperature coefficient: 5 ppm/°C maximum**
- High output current: 30 mA**
- Low supply current: 45  $\mu$ A maximum**
- Initial accuracy:  $\pm 2$  mV maximum<sup>1</sup>**
- Sleep mode: 15  $\mu$ A maximum**
- Low dropout voltage**
- Load regulation: 4 ppm/mA**
- Line regulation: 4 ppm/V**
- Short-circuit protection**

### APPLICATIONS

- Portable instruments**
- ADCs and DACs**
- Smart sensors**
- Solar powered applications**
- Loop-current-powered instruments**

### GENERAL DESCRIPTION

The REF19x series precision band gap voltage references use a patented temperature drift curvature correction circuit and laser trimming of highly stable, thin-film resistors to achieve a very low temperature coefficient and high initial accuracy.

The REF19x series is made up of micropower, low dropout voltage (LDV) devices, providing stable output voltage from supplies as low as 100 mV above the output voltage and consuming less than 45  $\mu$ A of supply current. In sleep mode, which is enabled by applying a low TTL or CMOS level to the SLEEP pin, the output is turned off and supply current is further reduced to less than 15  $\mu$ A.

The REF19x series references are specified over the extended industrial temperature range ( $-40^{\circ}\text{C}$  to  $+85^{\circ}\text{C}$ ) with typical performance specifications over  $-40^{\circ}\text{C}$  to  $+125^{\circ}\text{C}$  for applications, such as automotive.

All electrical grades are available in an 8-lead SOIC package; the PDIP and TSSOP packages are available only in the lowest electrical grade.

### TEST PINS

Test Pin 1 and Test Pin 5 are reserved for in-package Zener zap. To achieve the highest level of accuracy at the output, the Zener zapping technique is used to trim the output voltage. Because each unit may require a different amount of adjustment, the resistance value at the test pins varies widely from pin to pin and from part to part. The user should leave Pin 1 and Pin 5 unconnected.

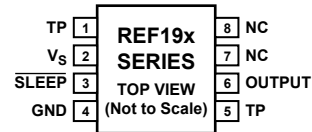

- NOTES**
1. NC = NO CONNECT.
  2. TP PINS ARE FACTORY TEST POINTS, NO USER CONNECTION.

00371-001

Figure 1. 8-Lead SOIC\_N and TSSOP Pin Configuration (S Suffix and RU Suffix)

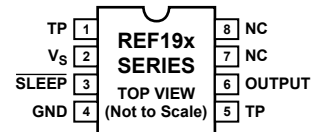

- NOTES**
1. NC = NO CONNECT.
  2. TP PINS ARE FACTORY TEST POINTS, NO USER CONNECTION.

00371-002

Figure 2. 8-Lead PDIP Pin Configuration (P Suffix)

**Table 1. Nominal Output Voltage**

| Part Number | Nominal Output Voltage (V) |
|-------------|----------------------------|
| REF191      | 2.048                      |
| REF192      | 2.50                       |
| REF193      | 3.00                       |
| REF194      | 4.50                       |
| REF195      | 5.00                       |
| REF196      | 3.30                       |
| REF198      | 4.096                      |

<sup>1</sup> Initial accuracy does not include shift due to solder heat effect (see the Applications Information section).

#### Rev. L

Information furnished by Analog Devices is believed to be accurate and reliable. However, no responsibility is assumed by Analog Devices for its use, nor for any infringements of patents or other rights of third parties that may result from its use. Specifications subject to change without notice. No license is granted by implication or otherwise under any patent or patent rights of Analog Devices. Trademarks and registered trademarks are the property of their respective owners.

## TABLE OF CONTENTS

|   |    |   |    |
|---|----|---|----|
| Features .....  | 1  | Electrical Characteristics—REF196 @ $-40^{\circ}\text{C} \leq T_A \leq +125^{\circ}\text{C}$<br>..... | 13 |
| Applications.....   | 1  | Electrical Characteristics—REF198 @ $T_A = 25^{\circ}\text{C}$ .....                                  | 14 |
| General Description .....   | 1  | Electrical Characteristics—REF198 @ $-40^{\circ}\text{C} \leq T_A \leq +85^{\circ}\text{C}$<br>.....  | 14 |
| Test Pins .....   | 1  | Electrical Characteristics—REF198 @ $-40^{\circ}\text{C} \leq T_A \leq 125^{\circ}\text{C}$ .....     | 15 |
| Revision History .....  | 3  | Absolute Maximum Ratings .....  | 16 |
| Specifications.....   | 4  | Thermal Resistance .....  | 16 |
| Electrical Characteristics—REF191 @ $T_A = 25^{\circ}\text{C}$ .....                                  | 4  | ESD Caution.....  | 16 |
| Electrical Characteristics—REF191 @ $-40^{\circ}\text{C} \leq +85^{\circ}\text{C}$ .....              | 5  | Typical Performance Characteristics .....   | 17 |
| Electrical Characteristics—REF191 @<br>$-40^{\circ}\text{C} \leq T_A \leq +125^{\circ}\text{C}$ ..... | 6  | Applications Information .....  | 20 |
| Electrical Characteristics—REF192 @ $T_A = 25^{\circ}\text{C}$ .....                                  | 6  | Output Short-Circuit Behavior .....   | 20 |
| Electrical Characteristics—REF192 @ $-40^{\circ}\text{C} \leq T_A \leq +85^{\circ}\text{C}$<br>.....  | 7  | Device Power Dissipation Considerations.....  | 20 |
| Electrical Characteristics—REF192 @ $-40^{\circ}\text{C} \leq T_A \leq +125^{\circ}\text{C}$<br>..... | 7  | Output Voltage Bypassing.....   | 20 |
| Electrical Characteristics—REF193 @ $T_A = 25^{\circ}\text{C}$ .....                                  | 8  | Sleep Mode Operation .....  | 20 |
| Electrical Characteristics—REF193 @ $-40^{\circ}\text{C} \leq T_A \leq +85^{\circ}\text{C}$<br>.....  | 8  | Basic Voltage Reference Connections .....   | 20 |
| Electrical Characteristics—REF193 @ $T_A \leq -40^{\circ}\text{C} \leq +125^{\circ}\text{C}$<br>..... | 9  | Membrane Switch-Controlled Power Supply.....  | 20 |
| Electrical Characteristics—REF194 @ $T_A = 25^{\circ}\text{C}$ .....                                  | 9  | Solder Heat Effect .....  | 21 |
| Electrical Characteristics—REF194 @ $-40^{\circ}\text{C} \leq T_A \leq +85^{\circ}\text{C}$<br>.....  | 10 | Current-Boosted References with Current Limiting.....   | 21 |
| Electrical Characteristics—REF194 @ $-40^{\circ}\text{C} \leq T_A \leq +125^{\circ}\text{C}$<br>..... | 10 | Negative Precision Reference Without Precision Resistors..  | 22 |
| Electrical Characteristics—REF195 @ $T_A = 25^{\circ}\text{C}$ .....                                  | 11 | Stacking Reference ICs for Arbitrary Outputs .....  | 22 |
| Electrical Characteristics—REF195 @ $-40^{\circ}\text{C} \leq T_A \leq +85^{\circ}\text{C}$<br>.....  | 11 | Precision Current Source .....  | 23 |
| Electrical Characteristics—REF195 @ $-40^{\circ}\text{C} \leq T_A \leq +125^{\circ}\text{C}$<br>..... | 12 | Switched Output 5 V/3.3 V Reference.....  | 23 |
| Electrical Characteristics—REF196 @ $T_A = 25^{\circ}\text{C}$ .....                                  | 12 | Kelvin Connections.....   | 24 |
| Electrical Characteristics—REF196 @ $-40^{\circ}\text{C} \leq T_A \leq +85^{\circ}\text{C}$<br>.....  | 13 | Fail-Safe 5 V Reference.....  | 24 |
|   |    | Low Power, Strain Gage Circuit .....  | 25 |
|   |    | Outline Dimensions .....  | 26 |
|   |    | Ordering Guide .....  | 27 |

**REVISION HISTORY****9/11—Rev. K to Rev. L**

|  |    |
|--|----|
| Change to Condition Column for Dropout Voltage Parameter, Table 2..... | 4  |
| Change to Condition Column for Dropout Voltage Parameter, Table 3..... | 5  |
| Change to Operating Temperature Range, Table 23.....                   | 16 |

**7/10—Rev. J to Rev. K**

|   |    |
|---|----|
| Add Note 1, Features Section.....   | 1  |
| Changes to Note 1, Table 2.....   | 4  |
| Changes to Note 1, Table 5.....   | 6  |
| Changes to Note 1, Table 8.....   | 8  |
| Changes to Note 1, Table 11.....  | 9  |
| Changes to Note 1, Table 14.....  | 11 |
| Changes to Note 1, Table 17.....  | 12 |
| Changes to Note 1, Table 20.....  | 14 |
| Moved Figure 22.....  | 20 |
| Added Figure 23, Solder Heat Effect Section, and Figure 24; Renumbered Sequentially ..... | 21 |
| Moved Negative Precision Reference Without Precision Resistors Section.....               | 22 |
| Moved Precision Current Source Section .....  | 23 |
| Moved Kelvin Connections Section .....  | 24 |
| Moved Figure 32.....  | 25 |
| Updated Outline Dimensions.....   | 26 |
| Changes to Ordering Guide.....  | 27 |

**3/08—Rev. I to Rev. J**

|   |    |
|---|----|
| Changes to General Description .....                                      | 1  |
| Changes to Specifications Section.....                                    | 4  |
| Deleted Wafer Test Limits Section .....                                   | 14 |
| Changes to Table 23, Thermal Resistance Section, and Table 24 .....       | 16 |
| Changes to Figure 6.....  | 17 |
| Changes to Device Power Dissipation Considerations Section.....           | 20 |
| Changes to Current-Boosted References with Current Limiting Section ..... | 21 |

|  |    |
|--|----|
| Changes to Precision Current Source Section .....      | 22 |
| Changes to Figure 28 .....                             | 23 |
| Changes to Figure 30 .....                             | 24 |
| Changes to Low Power, Strain Gage Circuit Section..... | 25 |
| Changes to Ordering Guide.....                         | 27 |

**9/06—Rev. H to Rev. I**

|   |           |
|---|-----------|
| Updated Format .....  | Universal |
| Changes to Table 25 .....                                       | 16        |
| Changes to Figure 6 .....                                       | 16        |
| Changes to Figure 10, Figure 12, Figure 14, and Figure 26 ..... | 17        |
| Changes to Figure 18 .....                                      | 18        |
| Changes to Figure 20 .....                                      | 19        |
| Changes to Figure 23 .....                                      | 20        |
| Changes to Figure 25 .....                                      | 21        |
| Updated Outline Dimensions.....                                 | 25        |
| Changes to Ordering Guide.....                                  | 26        |

**6/05—Rev. G to Rev. H**

|                                     |           |
|-------------------------------------|-----------|
| Updated Format .....                | Universal |
| Changes to Caption in Figure 7..... | 16        |
| Updated Outline Dimensions.....     | 25        |
| Changes to Ordering Guide.....      | 26        |

**7/04—Rev. F to Rev. G**

|                                |   |
|--------------------------------|---|
| Changes to Ordering Guide..... | 4 |
|--------------------------------|---|

**3/04—Rev. E to Rev. F**

|                                      |    |
|--------------------------------------|----|
| Updated Absolute Maximum Rating..... | 4  |
| Changes to Ordering Guide.....       | 14 |
| Updated Outline Dimensions.....      | 24 |

**1/03—Rev. D to Rev. E**

|  |    |
|--|----|
| Changes to Figure 3 and Figure 4 .....         | 15 |
| Changes to Output Short Circuit Behavior ..... | 17 |
| Changes to Figure 20 .....                     | 17 |
| Changes to Figure 26 .....                     | 19 |
| Updated Outline Dimensions.....                | 23 |

**1/96—Revision 0: Initial Version**

## SPECIFICATIONS

ELECTRICAL CHARACTERISTICS—REF191 @  $T_A = 25^\circ\text{C}$ 

@  $V_S = 3.3\text{ V}$ ,  $T_A = 25^\circ\text{C}$ , unless otherwise noted.

Table 2.

| Parameter                        | Symbol                         | Condition   | Min   | Typ   | Max   | Unit              |
|----------------------------------|--------------------------------|---|-------|-------|-------|-------------------|
| INITIAL ACCURACY <sup>1</sup>    | $V_O$                          |   |       |       |       |                   |
| E Grade                          |                                | $I_{OUT} = 0\text{ mA}$   | 2.046 | 2.048 | 2.050 | V                 |
| F Grade                          |                                |   | 2.043 |       | 2.053 | V                 |
| G Grade                          |                                |   | 2.038 |       | 2.058 | V                 |
| LINE REGULATION <sup>2</sup>     | $\Delta V_O / \Delta V_{IN}$   |   |       |       |       |                   |
| E Grade                          |                                | $3.0\text{ V} \leq V_S \leq 15\text{ V}$ , $I_{OUT} = 0\text{ mA}$  |       | 2     | 4     | ppm/V             |
| F and G Grades                   |                                |   |       | 4     | 8     | ppm/V             |
| LOAD REGULATION <sup>2</sup>     | $\Delta V_O / \Delta V_{LOAD}$ |   |       |       |       |                   |
| E Grade                          |                                | $V_S = 5.0\text{ V}$ , $0\text{ mA} \leq I_{OUT} \leq 30\text{ mA}$ |       | 4     | 10    | ppm/mA            |
| F and G Grades                   |                                |   |       | 6     | 15    | ppm/mA            |
| DROPOUT VOLTAGE                  | $V_S - V_O$                    |   |       |       |       |                   |
|                                  |                                | $V_S = 3.0\text{ V}$ , $I_{LOAD} = 2\text{ mA}$                     |       |       | 0.95  | V                 |
|                                  |                                | $V_S = 3.3\text{ V}$ , $I_{LOAD} = 10\text{ mA}$                    |       |       | 1.25  | V                 |
|                                  |                                | $V_S = 3.6\text{ V}$ , $I_{LOAD} = 30\text{ mA}$                    |       |       | 1.55  | V                 |
| LONG-TERM STABILITY <sup>3</sup> | $DV_O$                         | 1000 hours @ $125^\circ\text{C}$                                    |       | 1.2   |       | mV                |
| NOISE VOLTAGE                    | $e_N$                          | 0.1 Hz to 10 Hz   |       | 20    |       | $\mu\text{V p-p}$ |

<sup>1</sup> Initial accuracy does not include shift due to solder heat effect (see the Applications Information section).

<sup>2</sup> Line and load regulation specifications include the effect of self-heating.

<sup>3</sup> Long-term stability specification is noncumulative. The drift in subsequent 1000-hour periods is significantly lower than in the first 1000-hour period.

**ELECTRICAL CHARACTERISTICS—REF191 @  $-40^{\circ}\text{C} \leq +85^{\circ}\text{C}$** 

@  $V_S = 3.3\text{ V}$ ,  $-40^{\circ}\text{C} \leq T_A \leq +85^{\circ}\text{C}$ , unless otherwise noted.

**Table 3.**

| Parameter                               | Symbol                              | Condition  | Min | Typ | Max | Unit |      |        |        |
|---|-------------------------------------|--|-----|-----|-----|------|------|--------|--------|
| TEMPERATURE COEFFICIENT <sup>1, 2</sup> | TCV <sub>O</sub> /°C                | I <sub>OUT</sub> = 0 mA  |     |     |     |      |      |        |        |
| E Grade                                 |                                     |  |     |     |     |      | 2    | 5      | ppm/°C |
| F Grade                                 |                                     |  |     |     |     |      | 5    | 10     | ppm/°C |
| G Grade <sup>3</sup>                    |                                     |  |     |     |     | 10   | 25   | ppm/°C |        |
| LINE REGULATION <sup>4</sup>            | ΔV <sub>O</sub> /ΔV <sub>IN</sub>   | 3.0 V ≤ V <sub>S</sub> ≤ 15 V, I <sub>OUT</sub> = 0 mA   |     |     |     |      |      |        |        |
| E Grade                                 |                                     |  |     |     |     |      | 5    | 10     | ppm/V  |
| F and G Grades                          |                                     |  |     |     |     | 10   | 20   | ppm/V  |        |
| LOAD REGULATION <sup>4</sup>            | ΔV <sub>O</sub> /ΔV <sub>LOAD</sub> | V <sub>S</sub> = 5.0 V, 0 mA ≤ I <sub>OUT</sub> ≤ 25 mA  |     |     |     |      |      |        |        |
| E Grade                                 |                                     |  |     |     |     |      | 5    | 15     | ppm/mA |
| F and G Grades                          |                                     |  |     |     |     | 10   | 20   | ppm/mA |        |
| DROPOUT VOLTAGE                         | V <sub>S</sub> – V <sub>O</sub>     | V <sub>S</sub> = 3.0 V, I <sub>LOAD</sub> = 2 mA<br>V <sub>S</sub> = 3.3 V, I <sub>LOAD</sub> = 10 mA<br>V <sub>S</sub> = 3.6 V, I <sub>LOAD</sub> = 25 mA |     |     |     |      |      |        |        |
|   |                                     |  |     |     |     |      | 0.95 | V      |        |
|   |                                     |  |     |     |     |      | 1.25 | V      |        |
|   |                                     |  |     |     |     | 1.55 | V    |        |        |
| SLEEP PIN                               |                                     |  |     |     |     |      |      |        |        |
| Logic High Input Voltage                | V <sub>H</sub>                      |  | 2.4 |     |     |      |      | V      |        |
| Logic High Input Current                | I <sub>H</sub>                      |  |     |     |     |      |      | –8     | μA     |
| Logic Low Input Voltage                 | V <sub>L</sub>                      |  |     |     |     |      |      | 0.8    | V      |
| Logic Low Input Current                 | I <sub>L</sub>                      |  |     |     |     |      |      | –8     | μA     |
| SUPPLY CURRENT                          |                                     | No load  |     |     |     |      |      | 45     | μA     |
| Sleep Mode                              |                                     | No load  |     |     |     |      |      | 15     | μA     |

<sup>1</sup> For proper operation, a 1 μF capacitor is required between the output pin and the GND pin of the device.

<sup>2</sup> TCV<sub>O</sub> is defined as the ratio of output change with temperature variation to the specified temperature range expressed in ppm/°C.

$$TCV_O = (V_{MAX} - V_{MIN}) / V_O (T_{MAX} - T_{MIN})$$

<sup>3</sup> Guaranteed by characterization.

<sup>4</sup> Line and load regulation specifications include the effect of self-heating.

**ELECTRICAL CHARACTERISTICS—REF191 @  $-40^{\circ}\text{C} \leq T_A \leq +125^{\circ}\text{C}$** 

@  $V_S = 3.3\text{ V}$ ,  $-40^{\circ}\text{C} \leq T_A \leq +125^{\circ}\text{C}$ , unless otherwise noted.

**Table 4.**

| Parameter                               | Symbol                              | Condition   | Min | Typ | Max  | Unit   |
|---|-------------------------------------|---|-----|-----|------|--------|
| TEMPERATURE COEFFICIENT <sup>1, 2</sup> | TCV <sub>O</sub> /°C                | I <sub>OUT</sub> = 0 mA                                 |     | 2   |      | ppm/°C |
| E Grade                                 |                                     |   |     |     |      |        |
| F Grade                                 |                                     |   |     |     |      |        |
| G Grade <sup>3</sup>                    |                                     |   |     | 10  |      | ppm/°C |
| LINE REGULATION <sup>4</sup>            | ΔV <sub>O</sub> /ΔV <sub>IN</sub>   | 3.0 V ≤ V <sub>S</sub> ≤ 15 V, I <sub>OUT</sub> = 0 mA  |     | 10  |      | ppm/V  |
| E Grade                                 |                                     |   |     |     |      |        |
| F and G Grades                          |                                     |   |     | 20  |      | ppm/V  |
| LOAD REGULATION <sup>4</sup>            | ΔV <sub>O</sub> /ΔV <sub>LOAD</sub> | V <sub>S</sub> = 5.0 V, 0 mA ≤ I <sub>OUT</sub> ≤ 20 mA |     | 10  |      | ppm/mA |
| E Grade                                 |                                     |   |     |     |      |        |
| F and G Grades                          |                                     |   |     | 20  |      | ppm/mA |
| DROPOUT VOLTAGE                         | V <sub>S</sub> – V <sub>O</sub>     | V <sub>S</sub> = 3.3 V, I <sub>LOAD</sub> = 10 mA       |     |     | 1.25 | V      |
|   |                                     | V <sub>S</sub> = 3.6 V, I <sub>LOAD</sub> = 20 mA       |     |     | 1.55 | V      |

<sup>1</sup> For proper operation, a 1 μF capacitor is required between the output pin and the GND pin of the device.

<sup>2</sup> TCV<sub>O</sub> is defined as the ratio of output change with temperature variation to the specified temperature range expressed in ppm/°C.

$$TCV_O = (V_{MAX} - V_{MIN}) / V_O (T_{MAX} - T_{MIN})$$

<sup>3</sup> Guaranteed by characterization.

<sup>4</sup> Line and load regulation specifications include the effect of self-heating.

**ELECTRICAL CHARACTERISTICS—REF192 @ T<sub>A</sub> = 25°C**

@ V<sub>S</sub> = 3.3 V, T<sub>A</sub> = 25°C, unless otherwise noted.

**Table 5.**

| Parameter                        | Symbol                              | Condition   | Min   | Typ   | Max   | Unit   |
|----------------------------------|-------------------------------------|---|-------|-------|-------|--------|
| INITIAL ACCURACY <sup>1</sup>    | V <sub>O</sub>                      | I <sub>OUT</sub> = 0 mA                                 | 2.498 | 2.500 | 2.502 | V      |
| E Grade                          |                                     |   |       |       |       |        |
| F Grade                          |                                     |   |       |       |       |        |
| G Grade                          |                                     |   | 2.495 |       | 2.505 | V      |
| LINE REGULATION <sup>2</sup>     | ΔV <sub>O</sub> /ΔV <sub>IN</sub>   | 3.0 V ≤ V <sub>S</sub> ≤ 15 V, I <sub>OUT</sub> = 0 mA  |       | 2     | 4     | ppm/V  |
| E Grade                          |                                     |   |       |       |       |        |
| F and G Grades                   |                                     |   |       | 4     | 8     | ppm/V  |
| LOAD REGULATION <sup>2</sup>     | ΔV <sub>O</sub> /ΔV <sub>LOAD</sub> | V <sub>S</sub> = 5.0 V, 0 mA ≤ I <sub>OUT</sub> ≤ 30 mA |       | 4     | 10    | ppm/mA |
| E Grade                          |                                     |   |       |       |       |        |
| F and G Grades                   |                                     |   |       | 6     | 15    | ppm/mA |
| DROPOUT VOLTAGE                  | V <sub>S</sub> – V <sub>O</sub>     | V <sub>S</sub> = 3.5 V, I <sub>LOAD</sub> = 10 mA       |       |       | 1.00  | V      |
|                                  |                                     | V <sub>S</sub> = 3.9 V, I <sub>LOAD</sub> = 30 mA       |       |       | 1.40  | V      |
| LONG-TERM STABILITY <sup>3</sup> | DV <sub>O</sub>                     | 1000 hours @ 125°C                                      |       | 1.2   |       | mV     |
| NOISE VOLTAGE                    | e <sub>N</sub>                      | 0.1 Hz to 10 Hz   |       | 25    |       | μV p-p |

<sup>1</sup> Initial accuracy does not include shift due to solder heat effect (see the Applications Information section).

<sup>2</sup> Line and load regulation specifications include the effect of self-heating.

<sup>3</sup> Long-term stability specification is noncumulative. The drift in subsequent 1000-hour periods is significantly lower than in the first 1000-hour period.

**ELECTRICAL CHARACTERISTICS—REF192 @  $-40^{\circ}\text{C} \leq T_A \leq +85^{\circ}\text{C}$** 

@  $V_S = 3.3\text{ V}$ ,  $-40^{\circ}\text{C} \leq T_A \leq +85^{\circ}\text{C}$ , unless otherwise noted.

Table 6.

| Parameter                               | Symbol                       | Condition   | Min | Typ | Max | Unit |               |                         |                         |
|---|------------------------------|---|-----|-----|-----|------|---------------|-------------------------|-------------------------|
| TEMPERATURE COEFFICIENT <sup>1, 2</sup> | $TCV_O/^{\circ}\text{C}$     | $I_{OUT} = 0\text{ mA}$   |     |     |     |      |               |                         |                         |
| E Grade                                 |                              |   |     |     |     |      | 2             | 5                       | ppm/ $^{\circ}\text{C}$ |
| F Grade                                 |                              |   |     |     |     |      | 5             | 10                      | ppm/ $^{\circ}\text{C}$ |
| G Grade <sup>3</sup>                    |                              |   |     |     |     | 10   | 25            | ppm/ $^{\circ}\text{C}$ |                         |
| LINE REGULATION <sup>4</sup>            | $\Delta V_O/\Delta V_{IN}$   | $3.0\text{ V} \leq V_S \leq 15\text{ V}$ , $I_{OUT} = 0\text{ mA}$  |     |     |     |      |               |                         |                         |
| E Grade                                 |                              |   |     |     |     |      | 5             | 10                      | ppm/V                   |
| F and G Grades                          |                              |   |     |     |     | 10   | 20            | ppm/V                   |                         |
| LOAD REGULATION <sup>4</sup>            | $\Delta V_O/\Delta V_{LOAD}$ | $V_S = 5.0\text{ V}$ , $0\text{ mA} \leq I_{OUT} \leq 25\text{ mA}$ |     |     |     |      |               |                         |                         |
| E Grade                                 |                              |   |     |     |     |      | 5             | 15                      | ppm/mA                  |
| F and G Grades                          |                              |   |     |     |     | 10   | 20            | ppm/mA                  |                         |
| DROPOUT VOLTAGE                         | $V_S - V_O$                  | $V_S = 3.5\text{ V}$ , $I_{LOAD} = 10\text{ mA}$                    |     |     |     | 1.00 | V             |                         |                         |
|   |                              | $V_S = 4.0\text{ V}$ , $I_{LOAD} = 25\text{ mA}$                    |     |     |     | 1.50 | V             |                         |                         |
| SLEEP PIN                               |                              |   |     |     |     |      |               |                         |                         |
| Logic High Input Voltage                | $V_H$                        |   | 2.4 |     |     |      | V             |                         |                         |
| Logic High Input Current                | $I_H$                        |   |     |     | -8  |      | $\mu\text{A}$ |                         |                         |
| Logic Low Input Voltage                 | $V_L$                        |   |     |     | 0.8 |      | V             |                         |                         |
| Logic Low Input Current                 | $I_L$                        |   |     |     | -8  |      | $\mu\text{A}$ |                         |                         |
| SUPPLY CURRENT                          |                              | No load   |     |     |     | 45   | $\mu\text{A}$ |                         |                         |
| Sleep Mode                              |                              | No load   |     |     |     | 15   | $\mu\text{A}$ |                         |                         |

<sup>1</sup> For proper operation, a 1  $\mu\text{F}$  capacitor is required between the output pin and the GND pin of the device.

<sup>2</sup>  $TCV_O$  is defined as the ratio of output change with temperature variation to the specified temperature range expressed in ppm/ $^{\circ}\text{C}$ .

$$TCV_O = (V_{MAX} - V_{MIN})/V_O(T_{MAX} - T_{MIN})$$

<sup>3</sup> Guaranteed by characterization.

<sup>4</sup> Line and load regulation specifications include the effect of self-heating.

**ELECTRICAL CHARACTERISTICS—REF192 @  $-40^{\circ}\text{C} \leq T_A \leq +125^{\circ}\text{C}$** 

@  $V_S = 3.3\text{ V}$ ,  $-40^{\circ}\text{C} \leq T_A \leq +125^{\circ}\text{C}$ , unless otherwise noted.

Table 7.

| Parameter                               | Symbol                       | Condition   | Min | Typ | Max | Unit |                         |  |                         |
|---|------------------------------|---|-----|-----|-----|------|-------------------------|--|-------------------------|
| TEMPERATURE COEFFICIENT <sup>1, 2</sup> | $TCV_O/^{\circ}\text{C}$     | $I_{OUT} = 0\text{ mA}$   |     |     |     |      |                         |  |                         |
| E Grade                                 |                              |   |     |     |     |      | 2                       |  | ppm/ $^{\circ}\text{C}$ |
| F Grade                                 |                              |   |     |     |     |      | 5                       |  | ppm/ $^{\circ}\text{C}$ |
| G Grade <sup>3</sup>                    |                              |   |     |     |     | 10   | ppm/ $^{\circ}\text{C}$ |  |                         |
| LINE REGULATION <sup>4</sup>            | $\Delta V_O/\Delta V_{IN}$   | $3.0\text{ V} \leq V_S \leq 15\text{ V}$ , $I_{OUT} = 0\text{ mA}$  |     |     |     |      |                         |  |                         |
| E Grade                                 |                              |   |     |     |     |      | 10                      |  | ppm/V                   |
| F and G Grades                          |                              |   |     |     |     | 20   | ppm/V                   |  |                         |
| LOAD REGULATION <sup>4</sup>            | $\Delta V_O/\Delta V_{LOAD}$ | $V_S = 5.0\text{ V}$ , $0\text{ mA} \leq I_{OUT} \leq 20\text{ mA}$ |     |     |     |      |                         |  |                         |
| E Grade                                 |                              |   |     |     |     |      | 10                      |  | ppm/mA                  |
| F and G Grades                          |                              |   |     |     |     | 20   | ppm/mA                  |  |                         |
| DROPOUT VOLTAGE                         | $V_S - V_O$                  | $V_S = 3.5\text{ V}$ , $I_{LOAD} = 10\text{ mA}$                    |     |     |     | 1.00 | V                       |  |                         |
|   |                              | $V_S = 4.0\text{ V}$ , $I_{LOAD} = 20\text{ mA}$                    |     |     |     | 1.50 | V                       |  |                         |

<sup>1</sup> For proper operation, a 1  $\mu\text{F}$  capacitor is required between the output pin and the GND pin of the device.

<sup>2</sup>  $TCV_O$  is defined as the ratio of output change with temperature variation to the specified temperature range expressed in ppm/ $^{\circ}\text{C}$ .

$$TCV_O = (V_{MAX} - V_{MIN})/V_O(T_{MAX} - T_{MIN})$$

<sup>3</sup> Guaranteed by characterization.

<sup>4</sup> Line and load regulation specifications include the effect of self-heating.

**ELECTRICAL CHARACTERISTICS—REF193 @ T<sub>A</sub> = 25°C**

@ V<sub>S</sub> = 3.3 V, T<sub>A</sub> = 25°C, unless otherwise noted.

**Table 8.**

| Parameter                                | Symbol                              | Condition  | Min   | Typ | Max          | Unit   |
|--|-------------------------------------|--|-------|-----|--------------|--------|
| INITIAL ACCURACY <sup>1</sup><br>G Grade | V <sub>O</sub>                      | I <sub>OUT</sub> = 0 mA  | 2.990 | 3.0 | 3.010        | V      |
| LINE REGULATION <sup>2</sup><br>G Grade  | ΔV <sub>O</sub> /ΔV <sub>IN</sub>   | 3.3 V, ≤ V <sub>S</sub> ≤ 15 V, I <sub>OUT</sub> = 0 mA  |       | 4   | 8            | ppm/V  |
| LOAD REGULATION <sup>2</sup><br>G Grade  | ΔV <sub>O</sub> /ΔV <sub>LOAD</sub> | V <sub>S</sub> = 5.0 V, 0 mA ≤ I <sub>OUT</sub> ≤ 30 mA  |       | 6   | 15           | ppm/mA |
| DROPOUT VOLTAGE                          | V <sub>S</sub> – V <sub>O</sub>     | V <sub>S</sub> = 3.8 V, I <sub>LOAD</sub> = 10 mA<br>V <sub>S</sub> = 4.0 V, I <sub>LOAD</sub> = 30 mA |       |     | 0.80<br>1.00 | V<br>V |
| LONG-TERM STABILITY <sup>3</sup>         | DV <sub>O</sub>                     | 1000 hours @ 125°C   |       | 1.2 |              | mV     |
| NOISE VOLTAGE                            | e <sub>N</sub>                      | 0.1 Hz to 10 Hz  |       | 30  |              | μV p-p |

<sup>1</sup> Initial accuracy does not include shift due to solder heat effect (see the Applications Information section).

<sup>2</sup> Line and load regulation specifications include the effect of self-heating.

<sup>3</sup> Long-term stability specification is noncumulative. The drift in subsequent 1000-hour periods is significantly lower than in the first 1000-hour period.

**ELECTRICAL CHARACTERISTICS—REF193 @ –40°C ≤ T<sub>A</sub> ≤ +85°C**

@ V<sub>S</sub> = 3.3 V, T<sub>A</sub> = –40°C ≤ T<sub>A</sub> ≤ +85°C, unless otherwise noted.

**Table 9.**

| Parameter   | Symbol                              | Condition  | Min | Typ | Max          | Unit   |
|---|-------------------------------------|--|-----|-----|--------------|--------|
| TEMPERATURE COEFFICIENT <sup>1, 2</sup><br>G Grade <sup>3</sup> | TCV <sub>O</sub> /°C                | I <sub>OUT</sub> = 0 mA  |     | 10  | 25           | ppm/°C |
| LINE REGULATION <sup>4</sup><br>G Grade                         | ΔV <sub>O</sub> /ΔV <sub>IN</sub>   | 3.3 V ≤ V <sub>S</sub> ≤ 15 V, I <sub>OUT</sub> = 0 mA   |     | 10  | 20           | ppm/V  |
| LOAD REGULATION <sup>4</sup><br>G Grade                         | ΔV <sub>O</sub> /ΔV <sub>LOAD</sub> | V <sub>S</sub> = 5.0 V, 0 mA ≤ I <sub>OUT</sub> ≤ 25 mA  |     | 10  | 20           | ppm/mA |
| DROPOUT VOLTAGE   | V <sub>S</sub> – V <sub>O</sub>     | V <sub>S</sub> = 3.8 V, I <sub>LOAD</sub> = 10 mA<br>V <sub>S</sub> = 4.1 V, I <sub>LOAD</sub> = 30 mA |     |     | 0.80<br>1.10 | V<br>V |
| SLEEP PIN   |                                     |  |     |     |              |        |
| Logic High Input Voltage  | V <sub>H</sub>                      |  | 2.4 |     |              | V      |
| Logic High Input Current  | I <sub>H</sub>                      |  |     |     | –8           | μA     |
| Logic Low Input Voltage   | V <sub>L</sub>                      |  |     |     | 0.8          | V      |
| Logic Low Input Current   | I <sub>L</sub>                      |  |     |     | –8           | μA     |
| SUPPLY CURRENT  |                                     | No load  |     |     | 45           | μA     |
| Sleep Mode  |                                     | No load  |     |     | 15           | μA     |

<sup>1</sup> For proper operation, a 1 μF capacitor is required between the output pin and the GND pin of the device.

<sup>2</sup> TCV<sub>O</sub> is defined as the ratio of output change with temperature variation to the specified temperature range expressed in ppm/°C.

$$TCV_O = (V_{MAX} - V_{MIN}) / V_O (T_{MAX} - T_{MIN})$$

<sup>3</sup> Guaranteed by characterization.

<sup>4</sup> Line and load regulation specifications include the effect of self-heating.

**ELECTRICAL CHARACTERISTICS—REF193 @  $T_A \leq -40^\circ\text{C} \leq +125^\circ\text{C}$** 

@  $V_S = 3.3\text{ V}$ ,  $-40^\circ\text{C} \leq T_A \leq +125^\circ\text{C}$ , unless otherwise noted.

**Table 10.**

| Parameter   | Symbol                       | Condition   | Min | Typ | Max  | Unit                  |
|---|------------------------------|---|-----|-----|------|-----------------------|
| TEMPERATURE COEFFICIENT <sup>1, 2</sup><br>G Grade <sup>3</sup> | $TCV_O/^\circ\text{C}$       | $I_{OUT} = 0\text{ mA}$   |     | 10  |      | ppm/ $^\circ\text{C}$ |
| LINE REGULATION <sup>4</sup><br>G Grade                         | $\Delta V_O/\Delta V_{IN}$   | $3.3\text{ V} \leq V_S \leq 15\text{ V}$ , $I_{OUT} = 0\text{ mA}$  |     | 20  |      | ppm/V                 |
| LOAD REGULATION <sup>4</sup><br>G Grade                         | $\Delta V_O/\Delta V_{LOAD}$ | $V_S = 5.0\text{ V}$ , $0\text{ mA} \leq I_{OUT} \leq 20\text{ mA}$ |     | 10  |      | ppm/mA                |
| DROPOUT VOLTAGE   | $V_S - V_O$                  | $V_S = 3.8\text{ V}$ , $I_{LOAD} = 10\text{ mA}$                    |     |     | 0.80 | V                     |
|   |                              | $V_S = 4.1\text{ V}$ , $I_{LOAD} = 20\text{ mA}$                    |     |     | 1.10 | V                     |

<sup>1</sup> For proper operation, a 1  $\mu\text{F}$  capacitor is required between the output pin and the GND pin of the device.

<sup>2</sup>  $TCV_O$  is defined as the ratio of output change with temperature variation to the specified temperature range expressed in ppm/ $^\circ\text{C}$ .

$$TCV_O = (V_{MAX} - V_{MIN})/V_O(T_{MAX} - T_{MIN})$$

<sup>3</sup> Guaranteed by characterization.

<sup>4</sup> Line and load regulation specifications include the effect of self-heating.

**ELECTRICAL CHARACTERISTICS—REF194 @  $T_A = 25^\circ\text{C}$** 

@  $V_S = 5.0\text{ V}$ ,  $T_A = 25^\circ\text{C}$ , unless otherwise noted.

**Table 11.**

| Parameter   | Symbol                       | Condition   | Min            | Typ    | Max            | Unit              |
|---|------------------------------|---|----------------|--------|----------------|-------------------|
| INITIAL ACCURACY <sup>1</sup><br>E Grade<br>G Grade | $V_O$                        | $I_{OUT} = 0\text{ mA}$   | 4.498<br>4.490 | 4.5    | 4.502<br>4.510 | V<br>V            |
| LINE REGULATION <sup>2</sup><br>E Grade<br>G Grade  | $\Delta V_O/\Delta V_{IN}$   | $4.75\text{ V} \leq V_S \leq 15\text{ V}$ , $I_{OUT} = 0\text{ mA}$ |                | 2<br>4 | 4<br>8         | ppm/V<br>ppm/V    |
| LOAD REGULATION <sup>2</sup><br>E Grade<br>G Grade  | $\Delta V_O/\Delta V_{LOAD}$ | $V_S = 5.8\text{ V}$ , $0\text{ mA} \leq I_{OUT} \leq 30\text{ mA}$ |                | 2<br>4 | 4<br>8         | ppm/mA<br>ppm/mA  |
| DROPOUT VOLTAGE                                     | $V_S - V_O$                  | $V_S = 5.00\text{ V}$ , $I_{LOAD} = 10\text{ mA}$                   |                |        | 0.50           | V                 |
|   |                              | $V_S = 5.8\text{ V}$ , $I_{LOAD} = 30\text{ mA}$                    |                |        | 1.30           | V                 |
| LONG-TERM STABILITY <sup>3</sup>                    | $DV_O$                       | 1000 hours @ $125^\circ\text{C}$                                    |                | 2      |                | mV                |
| NOISE VOLTAGE                                       | $e_N$                        | 0.1 Hz to 10 Hz   |                | 45     |                | $\mu\text{V p-p}$ |

<sup>1</sup> Initial accuracy does not include shift due to solder heat effect (see the Applications Information section).

<sup>2</sup> Line and load regulation specifications include the effect of self-heating.

<sup>3</sup> Long-term stability specification is noncumulative. The drift in subsequent 1000-hour periods is significantly lower than in the first 1000-hour period.

**ELECTRICAL CHARACTERISTICS—REF194 @  $-40^{\circ}\text{C} \leq T_A \leq +85^{\circ}\text{C}$** @  $V_S = 5.0\text{ V}$ ,  $T_A = -40^{\circ}\text{C} \leq T_A \leq +85^{\circ}\text{C}$ , unless otherwise noted.

Table 12.

| Parameter                               | Symbol                          | Condition  | Min | Typ | Max | Unit |    |        |
|---|---------------------------------|--|-----|-----|-----|------|----|--------|
| TEMPERATURE COEFFICIENT <sup>1, 2</sup> | TCV <sub>O</sub> /°C            | I <sub>OUT</sub> = 0 mA                                  |     |     |     |      |    |        |
| E Grade                                 |                                 |  |     |     |     |      | 2  | 5      |
| G Grade <sup>3</sup>                    |                                 |  |     |     |     | 10   | 25 | ppm/°C |
| LINE REGULATION <sup>4</sup>            | $\Delta V_O/\Delta V_{IN}$      | 4.75 V ≤ V <sub>S</sub> ≤ 15 V, I <sub>OUT</sub> = 0 mA  |     |     |     |      |    |        |
| E Grade                                 |                                 |  |     |     |     |      | 5  | 10     |
| G Grade                                 |                                 |  |     |     |     | 10   | 20 | ppm/V  |
| LOAD REGULATION <sup>4</sup>            | $\Delta V_O/\Delta V_{LOAD}$    | V <sub>S</sub> = 5.80 V, 0 mA ≤ I <sub>OUT</sub> ≤ 25 mA |     |     |     |      |    |        |
| E Grade                                 |                                 |  |     |     |     |      | 5  | 15     |
| G Grade                                 |                                 |  |     |     |     | 10   | 20 | ppm/mA |
| DROPOUT VOLTAGE                         | V <sub>S</sub> – V <sub>O</sub> | V <sub>S</sub> = 5.00 V, I <sub>LOAD</sub> = 10 mA       |     |     |     | 0.5  | V  |        |
|   |                                 | V <sub>S</sub> = 5.80 V, I <sub>LOAD</sub> = 25 mA       |     |     |     | 1.30 | V  |        |
| SLEEP PIN                               |                                 |  |     |     |     |      |    |        |
| Logic High Input Voltage                | V <sub>H</sub>                  |  | 2.4 |     |     |      | V  |        |
| Logic High Input Current                | I <sub>H</sub>                  |  |     |     |     | –8   | μA |        |
| Logic Low Input Voltage                 | V <sub>L</sub>                  |  |     |     |     | 0.8  | V  |        |
| Logic Low Input Current                 | I <sub>L</sub>                  |  |     |     |     | –8   | μA |        |
| SUPPLY CURRENT                          |                                 | No load  |     |     |     | 45   | μA |        |
| Sleep Mode                              |                                 | No load  |     |     |     | 15   | μA |        |

<sup>1</sup> For proper operation, a 1 μF capacitor is required between the output pin and the GND pin of the device.<sup>2</sup> TCV<sub>O</sub> is defined as the ratio of output change with temperature variation to the specified temperature range expressed in ppm/°C.

$$TCV_O = (V_{MAX} - V_{MIN})/V_O(T_{MAX} - T_{MIN})$$

<sup>3</sup> Guaranteed by characterization.<sup>4</sup> Line and load regulation specifications include the effect of self-heating.**ELECTRICAL CHARACTERISTICS—REF194 @  $-40^{\circ}\text{C} \leq T_A \leq +125^{\circ}\text{C}$** @  $V_S = 5.0\text{ V}$ ,  $-40^{\circ}\text{C} \leq T_A \leq +125^{\circ}\text{C}$ , unless otherwise noted.

Table 13.

| Parameter                               | Symbol                          | Condition  | Min | Typ | Max | Unit |        |
|---|---------------------------------|--|-----|-----|-----|------|--------|
| TEMPERATURE COEFFICIENT <sup>1, 2</sup> | TCV <sub>O</sub> /°C            | I <sub>OUT</sub> = 0 mA                                  |     |     |     |      |        |
| E Grade                                 |                                 |  |     |     |     |      | 2      |
| G Grade <sup>3</sup>                    |                                 |  |     |     |     | 10   | ppm/°C |
| LINE REGULATION <sup>4</sup>            | $\Delta V_O/\Delta V_{IN}$      | 4.75 V ≤ V <sub>S</sub> ≤ 15 V, I <sub>OUT</sub> = 0 mA  |     |     |     |      |        |
| E Grade                                 |                                 |  |     |     |     |      | 5      |
| G Grade                                 |                                 |  |     |     |     | 10   | ppm/V  |
| LOAD REGULATION                         | $\Delta V_O/\Delta V_{LOAD}$    | V <sub>S</sub> = 5.80 V, 0 mA ≤ I <sub>OUT</sub> ≤ 20 mA |     |     |     |      |        |
| E Grade                                 |                                 |  |     |     |     |      | 5      |
| Grade                                   |                                 |  |     |     |     | 10   | ppm/mA |
| DROPOUT VOLTAGE                         | V <sub>S</sub> – V <sub>O</sub> | V <sub>S</sub> = 5.10 V, I <sub>LOAD</sub> = 10 mA       |     |     |     | 0.60 | V      |
|   |                                 | V <sub>S</sub> = 5.95 V, I <sub>LOAD</sub> = 20 mA       |     |     |     | 1.45 | V      |

<sup>1</sup> For proper operation, a 1 μF capacitor is required between the output pin and the GND pin of the device.<sup>2</sup> TCV<sub>O</sub> is defined as the ratio of output change with temperature variation to the specified temperature range expressed in ppm/°C.

$$TCV_O = (V_{MAX} - V_{MIN})/V_O(T_{MAX} - T_{MIN})$$

<sup>3</sup> Guaranteed by characterization.<sup>4</sup> Line and load regulation specifications include the effect of self-heating.

**ELECTRICAL CHARACTERISTICS—REF195 @ T<sub>A</sub> = 25°C**@ V<sub>S</sub> = 5.10 V, T<sub>A</sub> = 25°C, unless otherwise noted.**Table 14.**

| Parameter                        | Symbol                              | Condition  | Min   | Typ | Max   | Unit   |
|----------------------------------|-------------------------------------|--|-------|-----|-------|--------|
| INITIAL ACCURACY <sup>1</sup>    | V <sub>O</sub>                      |  |       |     |       |        |
| E Grade                          |                                     | I <sub>OUT</sub> = 0 mA                                  | 4.998 | 5.0 | 5.002 | V      |
| F Grade                          |                                     |  | 4.995 |     | 5.005 | V      |
| G Grade                          |                                     |  | 4.990 |     | 5.010 | V      |
| LINE REGULATION <sup>2</sup>     | ΔV <sub>O</sub> /ΔV <sub>IN</sub>   |  |       |     |       |        |
| E Grade                          |                                     | 5.10 V ≤ V <sub>S</sub> ≤ 15 V, I <sub>OUT</sub> = 0 mA  |       | 2   | 4     | ppm/V  |
| F and G Grades                   |                                     |  |       | 4   | 8     | ppm/V  |
| LOAD REGULATION <sup>2</sup>     | ΔV <sub>O</sub> /ΔV <sub>LOAD</sub> |  |       |     |       |        |
| E Grade                          |                                     | V <sub>S</sub> = 6.30 V, 0 mA ≤ I <sub>OUT</sub> ≤ 30 mA |       | 2   | 4     | ppm/mA |
| F and G Grades                   |                                     |  |       | 4   | 8     | ppm/mA |
| DROPOUT VOLTAGE                  | V <sub>S</sub> – V <sub>O</sub>     |  |       |     |       |        |
|                                  |                                     | V <sub>S</sub> = 5.50 V, I <sub>LOAD</sub> = 10 mA       |       |     | 0.50  | V      |
|                                  |                                     | V <sub>S</sub> = 6.30 V, I <sub>LOAD</sub> = 30 mA       |       |     | 1.30  | V      |
| LONG-TERM STABILITY <sup>3</sup> | DV <sub>O</sub>                     | 1000 hours @ 125°C                                       |       | 1.2 |       | mV     |
| NOISE VOLTAGE                    | e <sub>N</sub>                      | 0.1 Hz to 10 Hz  |       | 50  |       | μV p-p |

<sup>1</sup> Initial accuracy does not include shift due to solder heat effect (see the Applications Information section).<sup>2</sup> Line and load regulation specifications include the effect of self-heating.<sup>3</sup> Long-term stability specification is noncumulative. The drift in subsequent 1000-hour periods is significantly lower than in the first 1000-hour period.**ELECTRICAL CHARACTERISTICS—REF195 @ –40°C ≤ T<sub>A</sub> ≤ +85°C**@ V<sub>S</sub> = 5.15 V, T<sub>A</sub> = –40°C ≤ T<sub>A</sub> ≤ +85°C, unless otherwise noted.**Table 15.**

| Parameter                               | Symbol                              | Condition  | Min | Typ | Max  | Unit   |
|---|-------------------------------------|--|-----|-----|------|--------|
| TEMPERATURE COEFFICIENT <sup>1, 2</sup> | TCV <sub>O</sub> /°C                |  |     |     |      |        |
| E Grade                                 |                                     | I <sub>OUT</sub> = 0 mA                                  |     | 2   | 5    | ppm/°C |
| F Grade                                 |                                     |  |     | 5   | 10   | ppm/°C |
| G Grade <sup>3</sup>                    |                                     |  |     | 10  | 25   | ppm/°C |
| LINE REGULATION <sup>4</sup>            | ΔV <sub>O</sub> /ΔV <sub>IN</sub>   |  |     |     |      |        |
| E Grade                                 |                                     | 5.15 V ≤ V <sub>S</sub> ≤ 15 V, I <sub>OUT</sub> = 0 mA  |     | 5   | 10   | ppm/V  |
| F and G Grades                          |                                     |  |     | 10  | 20   | ppm/V  |
| LOAD REGULATION <sup>4</sup>            | ΔV <sub>O</sub> /ΔV <sub>LOAD</sub> |  |     |     |      |        |
| E Grade                                 |                                     | V <sub>S</sub> = 6.30 V, 0 mA ≤ I <sub>OUT</sub> ≤ 25 mA |     | 5   | 10   | ppm/mA |
| F and G Grades                          |                                     |  |     | 10  | 20   | ppm/mA |
| DROPOUT VOLTAGE                         | V <sub>S</sub> – V <sub>O</sub>     |  |     |     |      |        |
|   |                                     | V <sub>S</sub> = 5.50 V, I <sub>LOAD</sub> = 10 mA       |     |     | 0.50 | V      |
|   |                                     | V <sub>S</sub> = 6.30 V, I <sub>LOAD</sub> = 25 mA       |     |     | 1.30 | V      |
| SLEEP PIN                               |                                     |  |     |     |      |        |
| Logic High Input Voltage                | V <sub>H</sub>                      |  | 2.4 |     |      | V      |
| Logic High Input Current                | I <sub>H</sub>                      |  |     |     | –8   | μA     |
| Logic Low Input Voltage                 | V <sub>L</sub>                      |  |     |     | 0.8  | V      |
| Logic Low Input Current                 | I <sub>L</sub>                      |  |     |     | –8   | μA     |
| SUPPLY CURRENT                          |                                     |  |     |     |      |        |
| Sleep Mode                              |                                     | No load  |     |     | 45   | μA     |
|   |                                     | No load  |     |     | 15   | μA     |

<sup>1</sup> For proper operation, a 1 μF capacitor is required between the output pin and the GND pin of the device.<sup>2</sup> TCV<sub>O</sub> is defined as the ratio of output change with temperature variation to the specified temperature range expressed in ppm/°C.

$$TCV_O = (V_{MAX} - V_{MIN}) / V_O (T_{MAX} - T_{MIN})$$

<sup>3</sup> Guaranteed by characterization.<sup>4</sup> Line and load regulation specifications include the effect of self-heating.

**ELECTRICAL CHARACTERISTICS—REF195 @  $-40^{\circ}\text{C} \leq T_A \leq +125^{\circ}\text{C}$** 

@  $V_S = 5.20\text{ V}$ ,  $-40^{\circ}\text{C} \leq T_A \leq +125^{\circ}\text{C}$ , unless otherwise noted.

Table 16.

| Parameter                               | Symbol                          | Condition  | Min | Typ | Max | Unit   |        |
|---|---------------------------------|--|-----|-----|-----|--------|--------|
| TEMPERATURE COEFFICIENT <sup>1, 2</sup> | TCV <sub>O</sub> /°C            | I <sub>OUT</sub> = 0 mA                                  |     | 2   |     | ppm/°C |        |
| E Grade                                 |                                 |  |     |     |     |        |        |
| F Grade                                 |                                 |  |     |     |     |        |        |
| G Grade <sup>3</sup>                    |                                 |  |     |     |     | 10     | ppm/°C |
| LINE REGULATION <sup>4</sup>            | $\Delta V_O/\Delta V_{IN}$      | 5.20 V ≤ V <sub>S</sub> ≤ 15 V, I <sub>OUT</sub> = 0 mA  |     | 5   |     | ppm/V  |        |
| E Grade                                 |                                 |  |     |     |     |        |        |
| F and G Grades                          |                                 |  |     |     |     |        | 10     |
| LOAD REGULATION <sup>4</sup>            | $\Delta V_O/\Delta V_{LOAD}$    | V <sub>S</sub> = 6.45 V, 0 mA ≤ I <sub>OUT</sub> ≤ 20 mA |     | 5   |     | ppm/mA |        |
| E Grade                                 |                                 |  |     |     |     |        |        |
| F and G Grades                          |                                 |  |     |     |     |        | 10     |
| DROPOUT VOLTAGE                         | V <sub>S</sub> – V <sub>O</sub> | V <sub>S</sub> = 5.60 V, I <sub>LOAD</sub> = 10 mA       |     |     |     | 0.60   | V      |
|   |                                 | V <sub>S</sub> = 6.45 V, I <sub>LOAD</sub> = 20 mA       |     |     |     | 1.45   | V      |

<sup>1</sup> For proper operation, a 1 μF capacitor is required between the output pin and the GND pin of the device.

<sup>2</sup> TCV<sub>O</sub> is defined as the ratio of output change with temperature variation to the specified temperature range expressed in ppm/°C.

$$TCV_O = (V_{MAX} - V_{MIN})/V_O(T_{MAX} - T_{MIN})$$

<sup>3</sup> Guaranteed by characterization.

<sup>4</sup> Line and load regulation specifications include the effect of self-heating.

**ELECTRICAL CHARACTERISTICS—REF196 @  $T_A = 25^{\circ}\text{C}$** 

@  $V_S = 3.5\text{ V}$ ,  $T_A = 25^{\circ}\text{C}$ , unless otherwise noted.

Table 17.

| Parameter                        | Symbol                          | Condition   | Min   | Typ | Max   | Unit   |   |
|----------------------------------|---------------------------------|---|-------|-----|-------|--------|---|
| INITIAL ACCURACY <sup>1</sup>    | V <sub>O</sub>                  | I <sub>OUT</sub> = 0 mA                                 | 3.290 | 3.3 | 3.310 | V      |   |
| G Grade                          |                                 |   |       |     |       |        |   |
| LINE REGULATION <sup>2</sup>     | $\Delta V_O/\Delta V_{IN}$      | 3.50 V ≤ V <sub>S</sub> ≤ 15 V, I <sub>OUT</sub> = 0 mA |       | 4   | 8     | ppm/V  |   |
| G Grade                          |                                 |   |       |     |       |        |   |
| LOAD REGULATION <sup>2</sup>     | $\Delta V_O/\Delta V_{LOAD}$    | V <sub>S</sub> = 5.0 V, 0 mA ≤ I <sub>OUT</sub> ≤ 30 mA |       | 6   | 15    | ppm/mA |   |
| G Grade                          |                                 |   |       |     |       |        |   |
| DROPOUT VOLTAGE                  | V <sub>S</sub> – V <sub>O</sub> | V <sub>S</sub> = 4.1 V, I <sub>LOAD</sub> = 10 mA       |       |     |       | 0.80   | V |
|                                  |                                 | V <sub>S</sub> = 4.3 V, I <sub>LOAD</sub> = 30 mA       |       |     |       | 1.00   | V |
| LONG-TERM STABILITY <sup>3</sup> | DV <sub>O</sub>                 | 1000 hours @ 125°C                                      |       | 1.2 |       | mV     |   |
| NOISE VOLTAGE                    | e <sub>N</sub>                  | 0.1 Hz to 10 Hz   |       | 33  |       | μV p-p |   |

<sup>1</sup> Initial accuracy does not include shift due to solder heat effect (see the Applications Information section).

<sup>2</sup> Line and load regulation specifications include the effect of self-heating.

<sup>3</sup> Long-term stability specification is noncumulative. The drift in subsequent 1000-hour periods is significantly lower than in the first 1000-hour period.

**ELECTRICAL CHARACTERISTICS—REF196 @  $-40^{\circ}\text{C} \leq T_A \leq +85^{\circ}\text{C}$** 

@  $V_S = 3.5\text{ V}$ ,  $T_A = -40^{\circ}\text{C} \leq T_A \leq +85^{\circ}\text{C}$ , unless otherwise noted.

Table 18.

| Parameter   | Symbol                       | Condition   | Min | Typ | Max  | Unit                    |
|---|------------------------------|---|-----|-----|------|-------------------------|
| TEMPERATURE COEFFICIENT <sup>1, 2</sup><br>G Grade <sup>3</sup> | $TCV_O/^{\circ}\text{C}$     | $I_{OUT} = 0\text{ mA}$   |     | 10  | 25   | ppm/ $^{\circ}\text{C}$ |
| LINE REGULATION <sup>4</sup><br>G Grade                         | $\Delta V_O/\Delta V_{IN}$   | $3.5\text{ V} \leq V_S \leq 15\text{ V}$ , $I_{OUT} = 0\text{ mA}$  |     | 10  | 20   | ppm/V                   |
| LOAD REGULATION <sup>4</sup><br>G Grade                         | $\Delta V_O/\Delta V_{LOAD}$ | $V_S = 5.0\text{ V}$ , $0\text{ mA} \leq I_{OUT} \leq 25\text{ mA}$ |     | 10  | 20   | ppm/mA                  |
| DROPOUT VOLTAGE   | $V_S - V_O$                  | $V_S = 4.1\text{ V}$ , $I_{LOAD} = 10\text{ mA}$                    |     |     | 0.80 | V                       |
|   |                              | $V_S = 4.3\text{ V}$ , $I_{LOAD} = 25\text{ mA}$                    |     |     | 1.00 | V                       |
| <b>SLEEP PIN</b>  |                              |   |     |     |      |                         |
| Logic High Input Voltage  | $V_H$                        |   | 2.4 |     |      | V                       |
| Logic High Input Current  | $I_H$                        |   |     |     | -8   | $\mu\text{A}$           |
| Logic Low Input Voltage   | $V_L$                        |   |     |     | 0.8  | V                       |
| Logic Low Input Current   | $I_L$                        |   |     |     | -8   | $\mu\text{A}$           |
| <b>SUPPLY CURRENT</b>   |                              |   |     |     |      |                         |
| Sleep Mode  |                              | No load   |     |     | 45   | $\mu\text{A}$           |
|   |                              | No load   |     |     | 15   | $\mu\text{A}$           |

<sup>1</sup> For proper operation, a 1  $\mu\text{F}$  capacitor is required between the output pin and the GND pin of the device.

<sup>2</sup>  $TCV_O$  is defined as the ratio of output change with temperature variation to the specified temperature range expressed in ppm/ $^{\circ}\text{C}$ .

$$TCV_O = (V_{MAX} - V_{MIN})/V_O(T_{MAX} - T_{MIN})$$

<sup>3</sup> Guaranteed by characterization.

<sup>4</sup> Line and load regulation specifications include the effect of self-heating.

**ELECTRICAL CHARACTERISTICS—REF196 @  $-40^{\circ}\text{C} \leq T_A \leq +125^{\circ}\text{C}$** 

@  $V_S = 3.50\text{ V}$ ,  $-40^{\circ}\text{C} \leq T_A \leq +125^{\circ}\text{C}$ , unless otherwise noted.

Table 19.

| Parameter   | Symbol                       | Condition   | Min | Typ | Max  | Unit                    |
|---|------------------------------|---|-----|-----|------|-------------------------|
| TEMPERATURE COEFFICIENT <sup>1, 2</sup><br>G Grade <sup>3</sup> | $TCV_O/^{\circ}\text{C}$     | $I_{OUT} = 0\text{ mA}$   |     | 10  |      | ppm/ $^{\circ}\text{C}$ |
| LINE REGULATION <sup>4</sup><br>G Grade                         | $\Delta V_O/\Delta V_{IN}$   | $3.50\text{ V} \leq V_S \leq 15\text{ V}$ , $I_{OUT} = 0\text{ mA}$ |     | 20  |      | ppm/V                   |
| LOAD REGULATION <sup>4</sup><br>G Grade                         | $\Delta V_O/\Delta V_{LOAD}$ | $V_S = 5.0\text{ V}$ , $0\text{ mA} \leq I_{OUT} \leq 20\text{ mA}$ |     | 20  |      | ppm/mA                  |
| DROPOUT VOLTAGE   | $V_S - V_O$                  | $V_S = 4.1\text{ V}$ , $I_{LOAD} = 10\text{ mA}$                    |     |     | 0.80 | V                       |
|   |                              | $V_S = 4.4\text{ V}$ , $I_{LOAD} = 20\text{ mA}$                    |     |     | 1.10 | V                       |

<sup>1</sup> For proper operation, a 1  $\mu\text{F}$  capacitor is required between the output pin and the GND pin of the device.

<sup>2</sup>  $TCV_O$  is defined as the ratio of output change with temperature variation to the specified temperature range expressed in ppm/ $^{\circ}\text{C}$ .

$$TCV_O = (V_{MAX} - V_{MIN})/V_O(T_{MAX} - T_{MIN})$$

<sup>3</sup> Guaranteed by characterization.

<sup>4</sup> Line and load regulation specifications include the effect of self-heating.

**ELECTRICAL CHARACTERISTICS—REF198 @ T<sub>A</sub> = 25°C**@ V<sub>S</sub> = 5.0 V, T<sub>A</sub> = 25°C, unless otherwise noted.

Table 20.

| Parameter                        | Symbol                              | Condition   | Min   | Typ   | Max   | Unit   |
|----------------------------------|-------------------------------------|---|-------|-------|-------|--------|
| INITIAL ACCURACY <sup>1</sup>    | V <sub>O</sub>                      |   |       |       |       |        |
| E Grade                          |                                     | I <sub>OUT</sub> = 0 mA                                 | 4.094 | 4.096 | 4.098 | V      |
| F Grade                          |                                     |   | 4.091 |       | 4.101 | V      |
| G Grade                          |                                     |   | 4.086 |       | 4.106 | V      |
| LINE REGULATION <sup>2</sup>     | ΔV <sub>O</sub> /ΔV <sub>IN</sub>   |   |       |       |       |        |
| E Grade                          |                                     | 4.5 V ≤ V <sub>S</sub> ≤ 15 V, I <sub>OUT</sub> = 0 mA  |       | 2     | 4     | ppm/V  |
| F and G Grades                   |                                     |   |       | 4     | 8     | ppm/V  |
| LOAD REGULATION <sup>2</sup>     | ΔV <sub>O</sub> /ΔV <sub>LOAD</sub> |   |       |       |       |        |
| E Grade                          |                                     | V <sub>S</sub> = 5.4 V, 0 mA ≤ I <sub>OUT</sub> ≤ 30 mA |       | 2     | 4     | ppm/mA |
| F and G Grades                   |                                     |   |       | 4     | 8     | ppm/mA |
| DROPOUT VOLTAGE                  | V <sub>S</sub> – V <sub>O</sub>     |   |       |       |       |        |
|                                  |                                     | V <sub>S</sub> = 4.6 V, I <sub>LOAD</sub> = 10 mA       |       |       | 0.502 | V      |
|                                  |                                     | V <sub>S</sub> = 5.4 V, I <sub>LOAD</sub> = 30 mA       |       |       | 1.30  | V      |
| LONG-TERM STABILITY <sup>3</sup> | DV <sub>O</sub>                     | 1000 hours @ 125°C                                      |       | 1.2   |       | mV     |
| NOISE VOLTAGE                    | e <sub>N</sub>                      | 0.1 Hz to 10 Hz   |       | 40    |       | μV p-p |

<sup>1</sup> Initial accuracy does not include shift due to solder heat effect (see the Applications Information section).<sup>2</sup> Line and load regulation specifications include the effect of self-heating.<sup>3</sup> Long-term stability specification is noncumulative. The drift in subsequent 1000-hour periods is significantly lower than in the first 1000-hour period.**ELECTRICAL CHARACTERISTICS—REF198 @ –40°C ≤ T<sub>A</sub> ≤ +85°C**@ V<sub>S</sub> = 5.0 V, –40°C ≤ T<sub>A</sub> ≤ +85°C, unless otherwise noted.

Table 21.

| Parameter                               | Symbol                              | Condition   | Min | Typ | Max   | Unit   |
|---|-------------------------------------|---|-----|-----|-------|--------|
| TEMPERATURE COEFFICIENT <sup>1, 2</sup> | TCV <sub>O</sub> /°C                |   |     |     |       |        |
| E Grade                                 |                                     | I <sub>OUT</sub> = 0 mA                                 |     | 2   | 5     | ppm/°C |
| F Grade                                 |                                     |   |     | 5   | 10    | ppm/°C |
| G Grade <sup>3</sup>                    |                                     |   |     | 10  | 25    | ppm/°C |
| LINE REGULATION <sup>4</sup>            | ΔV <sub>O</sub> /ΔV <sub>IN</sub>   |   |     |     |       |        |
| E Grade                                 |                                     | 4.5 V ≤ V <sub>S</sub> ≤ 15 V, I <sub>OUT</sub> = 0 mA  |     | 5   | 10    | ppm/V  |
| F and G Grades                          |                                     |   |     | 10  | 20    | ppm/V  |
| LOAD REGULATION <sup>4</sup>            | ΔV <sub>O</sub> /ΔV <sub>LOAD</sub> |   |     |     |       |        |
| E Grade                                 |                                     | V <sub>S</sub> = 5.4 V, 0 mA ≤ I <sub>OUT</sub> ≤ 25 mA |     | 5   | 10    | ppm/mA |
| F and G Grades                          |                                     |   |     | 10  | 20    | ppm/mA |
| DROPOUT VOLTAGE                         | V <sub>S</sub> – V <sub>O</sub>     |   |     |     |       |        |
|   |                                     | V <sub>S</sub> = 4.6 V, I <sub>LOAD</sub> = 10 mA       |     |     | 0.502 | V      |
|   |                                     | V <sub>S</sub> = 5.4 V, I <sub>LOAD</sub> = 25 mA       |     |     | 1.30  | V      |
| SLEEP PIN                               |                                     |   |     |     |       |        |
| Logic High Input Voltage                | V <sub>H</sub>                      |   | 2.4 |     |       | V      |
| Logic High Input Current                | I <sub>H</sub>                      |   |     |     | –8    | μA     |
| Logic Low Input Voltage                 | V <sub>L</sub>                      |   |     |     | 0.8   | V      |
| Logic Low Input Current                 | I <sub>L</sub>                      |   |     |     | –8    | μA     |
| SUPPLY CURRENT                          |                                     |   |     |     |       |        |
| Sleep Mode                              |                                     | No load   |     |     | 45    | μA     |
|   |                                     | No load   |     |     | 15    | μA     |

<sup>1</sup> For proper operation, a 1 μF capacitor is required between the output pin and the GND pin of the device.<sup>2</sup> TCV<sub>O</sub> is defined as the ratio of output change with temperature variation to the specified temperature range expressed in ppm/°C.

$$TCV_O = (V_{MAX} - V_{MIN}) / V_O (T_{MAX} - T_{MIN})$$

<sup>3</sup> Guaranteed by characterization.<sup>4</sup> Line and load regulation specifications include the effect of self-heating.

**ELECTRICAL CHARACTERISTICS—REF198 @  $-40^{\circ}\text{C} \leq T_A \leq +125^{\circ}\text{C}$** 

@  $V_S = 5.0\text{ V}$ ,  $-40^{\circ}\text{C} \leq T_A \leq +125^{\circ}\text{C}$ , unless otherwise noted.

Table 22.

| Parameter                               | Symbol                              | Condition  | Min | Typ | Max  | Unit |                         |                         |
|---|-------------------------------------|--|-----|-----|------|------|-------------------------|-------------------------|
| TEMPERATURE COEFFICIENT <sup>1, 2</sup> | $TCV_O/^{\circ}\text{C}$            | $I_{\text{OUT}} = 0\text{ mA}$   |     |     |      |      |                         |                         |
| E Grade                                 |                                     |  |     |     |      |      | 2                       | ppm/ $^{\circ}\text{C}$ |
| F Grade                                 |                                     |  |     |     |      |      | 5                       | ppm/ $^{\circ}\text{C}$ |
| G Grade <sup>3</sup>                    |                                     |  |     |     |      | 10   | ppm/ $^{\circ}\text{C}$ |                         |
| LINE REGULATION <sup>4</sup>            | $\Delta V_O/\Delta V_{\text{IN}}$   | $4.5\text{ V} \leq V_S \leq 15\text{ V}$ , $I_{\text{OUT}} = 0\text{ mA}$  |     |     |      |      |                         |                         |
| E Grade                                 |                                     |  |     |     |      |      | 5                       | ppm/V                   |
| F and G Grades                          |                                     |  |     |     |      | 10   | ppm/V                   |                         |
| LOAD REGULATION <sup>4</sup>            | $\Delta V_O/\Delta V_{\text{LOAD}}$ | $V_S = 5.6\text{ V}$ , $0\text{ mA} \leq I_{\text{OUT}} \leq 20\text{ mA}$ |     |     |      |      |                         |                         |
| E Grade                                 |                                     |  |     |     |      |      | 5                       | ppm/mA                  |
| F and G Grades                          |                                     |  |     |     |      | 10   | ppm/mA                  |                         |
| DROPOUT VOLTAGE                         | $V_S - V_O$                         | $V_S = 4.7\text{ V}$ , $I_{\text{LOAD}} = 10\text{ mA}$                    |     |     | 0.60 | V    |                         |                         |
|   |                                     | $V_S = 5.6\text{ V}$ , $I_{\text{LOAD}} = 20\text{ mA}$                    |     |     | 1.50 | V    |                         |                         |

<sup>1</sup> For proper operation, a 1  $\mu\text{F}$  capacitor is required between the output pin and the GND pin of the device.

<sup>2</sup>  $TCV_O$  is defined as the ratio of output change with temperature variation to the specified temperature range expressed in ppm/ $^{\circ}\text{C}$ .

$$TCV_O = (V_{\text{MAX}} - V_{\text{MIN}})/V_O(T_{\text{MAX}} - T_{\text{MIN}})$$

<sup>3</sup> Guaranteed by characterization.

<sup>4</sup> Line and load regulation specifications include the effect of self-heating.

## ABSOLUTE MAXIMUM RATINGS

Table 23.

| Parameter                            | Rating                  |
|--------------------------------------|-------------------------|
| Supply Voltage                       | -0.3 V to +18 V         |
| Output to GND                        | -0.3 V to $V_S + 0.3$ V |
| Output to GND Short-Circuit Duration | Indefinite              |
| Storage Temperature Range            |                         |
| PDIP, SOIC Package                   | -65°C to +150°C         |
| Operating Temperature Range          |                         |
| REF19x                               | -40°C to +125°C         |
| Junction Temperature Range           |                         |
| PDIP, SOIC Package                   | -65°C to +150°C         |
| Lead Temperature (Soldering 60 sec)  | 300°C                   |

Stresses above those listed under Absolute Maximum Ratings may cause permanent damage to the device. This is a stress rating only; functional operation of the device at these or any other conditions above those indicated in the operational section of this specification is not implied. Exposure to absolute maximum rating conditions for extended periods may affect device reliability.

## THERMAL RESISTANCE

$\theta_{JA}$  is specified for worst-case conditions; that is,  $\theta_{JA}$  is specified for the device in socket for PDIP and is specified for the device soldered in the circuit board for the SOIC and TSSOP packages.

Table 24.

| Package Type      | $\theta_{JA}$ | $\theta_{JC}$ | Unit |
|-------------------|---------------|---------------|------|
| 8-Lead PDIP (N)   | 103           | 43            | °C/W |
| 8-Lead SOIC (R)   | 158           | 43            | °C/W |
| 8-Lead TSSOP (RU) | 240           | 43            | °C/W |

## ESD CAUTION



**ESD (electrostatic discharge) sensitive device.** Charged devices and circuit boards can discharge without detection. Although this product features patented or proprietary protection circuitry, damage may occur on devices subjected to high energy ESD. Therefore, proper ESD precautions should be taken to avoid performance degradation or loss of functionality.

TYPICAL PERFORMANCE CHARACTERISTICS



Figure 3. REF195 Output Voltage vs. Temperature



Figure 6.  $T_cV_{OUT}$  Distribution

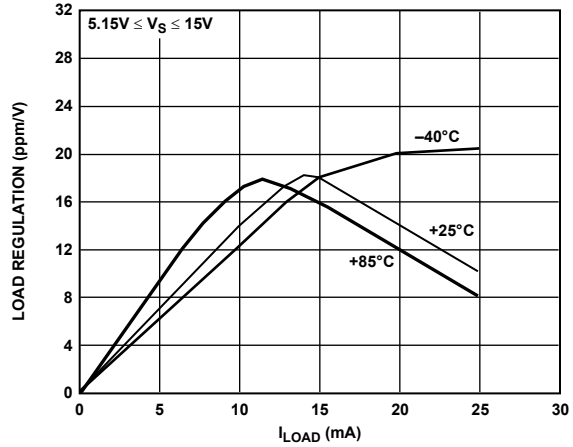

Figure 4. REF195 Load Regulator vs.  $I_{LOAD}$

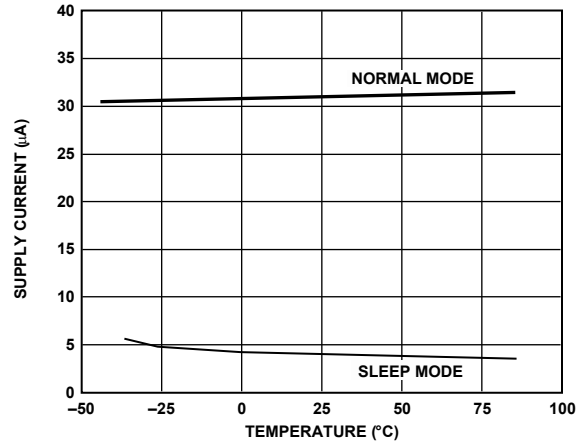

Figure 7. Supply Current vs. Temperature

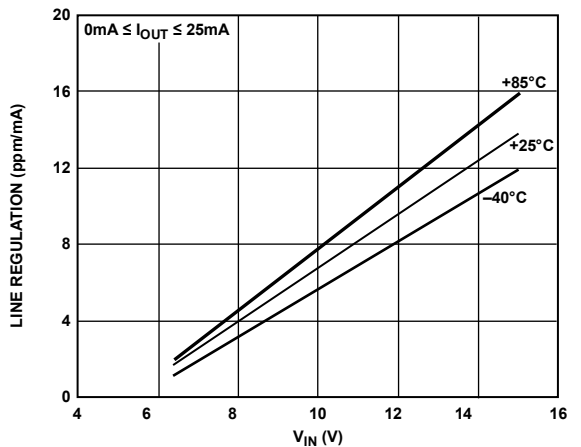

Figure 5. REF195 Line Regulator vs.  $V_{IN}$

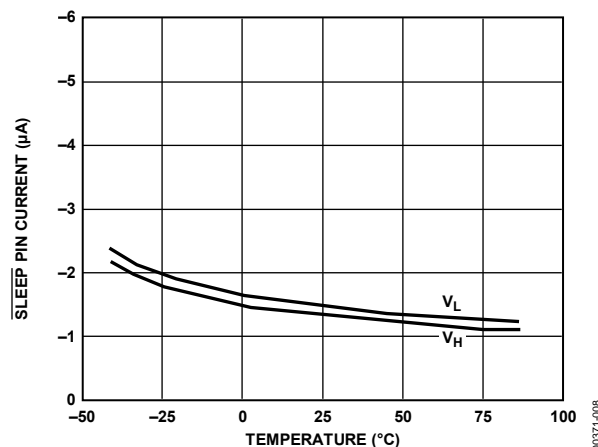

Figure 8. SLEEP Pin Current vs. Temperature



Figure 9. Ripple Rejection vs. Frequency

00371-009



Figure 12. Load Transient Response

00371-012

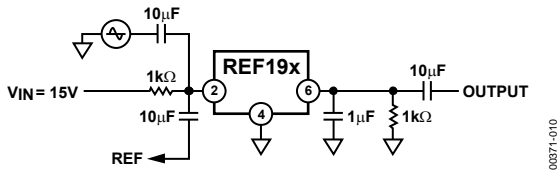

Figure 10. Ripple Rejection vs. Frequency Measurement Circuit

00371-010



Figure 13. Load Transient Response Measurement Circuit

00371-013

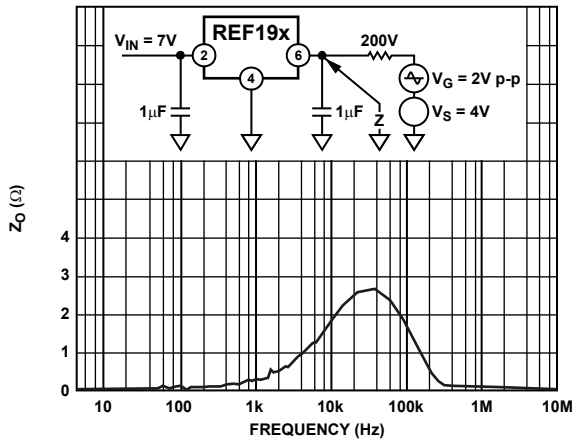

Figure 11. Output Impedance vs. Frequency

00371-011

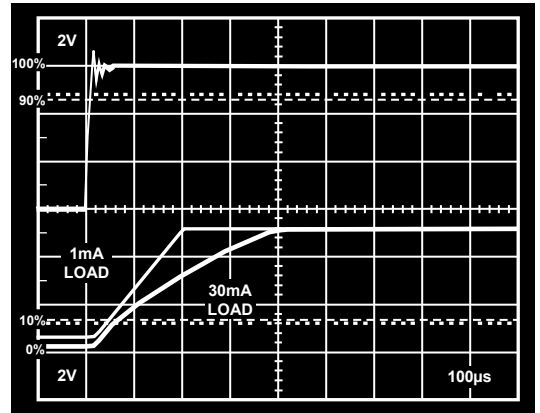

Figure 14. Power-On Response Time

00371-014



Figure 15. Power-On Response Time Measurement Circuit

00371-015



Figure 16.  $\overline{\text{SLEEP}}$  Response Time



Figure 18. Line Transient Response



Figure 17.  $\overline{\text{SLEEP}}$  Response Time Measurement Circuit



Figure 19. Load Current vs. REF195 Dropout Voltage

## APPLICATIONS INFORMATION

### OUTPUT SHORT-CIRCUIT BEHAVIOR

The REF19x family of devices is totally protected from damage due to accidental output shorts to GND or to  $V_S$ . In the event of an accidental short-circuit condition, the reference device shuts down and limits its supply current to 40 mA.



Figure 20. Simplified Schematic

### DEVICE POWER DISSIPATION CONSIDERATIONS

The REF19x family of references is capable of delivering load currents to 30 mA with an input voltage that ranges from 3.3 V to 15 V. When these devices are used in applications with large input voltages, exercise care to avoid exceeding the maximum internal power dissipation of these devices. Exceeding the published specifications for maximum power dissipation or junction temperature can result in premature device failure. The following formula should be used to calculate the maximum junction temperature or dissipation of the device:

$$P_D = \frac{T_J - T_A}{\theta_{JA}}$$

where  $T_J$  and  $T_A$  are the junction and ambient temperatures, respectively;  $P_D$  is the device power dissipation; and  $\theta_{JA}$  is the device package thermal resistance.

### OUTPUT VOLTAGE BYPASSING

For stable operation, low dropout voltage regulators and references generally require a bypass capacitor connected from their  $V_{OUT}$  pins to their GND pins. Although the REF19x family of references is capable of stable operation with capacitive loads exceeding 100  $\mu$ F, a 1  $\mu$ F capacitor is sufficient to guarantee rated performance. The addition of a 0.1  $\mu$ F ceramic capacitor in parallel with the bypass capacitor improves load current transient performance. For best line voltage transient performance, it is recommended that the voltage inputs of these devices be bypassed with a 10  $\mu$ F electrolytic capacitor in parallel with a 0.1  $\mu$ F ceramic capacitor.

### SLEEP MODE OPERATION

All REF19x devices include a sleep capability that is TTL/CMOS-level compatible. Internally, a pull-up current source to  $V_S$  is connected at the SLEEP pin. This permits the SLEEP pin to be driven from an open collector/drain driver. A logic low or a 0 V condition on the SLEEP pin is required to turn off the output stage. During sleep, the output of the references becomes a high impedance state where its potential would then be determined by external circuitry. If the sleep feature is not used, it is recommended that the SLEEP pin be connected to  $V_S$  (Pin 2).

### BASIC VOLTAGE REFERENCE CONNECTIONS

The circuit in Figure 21 illustrates the basic configuration for the REF19x family of references. Note the 10  $\mu$ F/0.1  $\mu$ F bypass network on the input and the 1  $\mu$ F/0.1  $\mu$ F bypass network on the output. It is recommended that no connections be made to Pin 1, Pin 5, Pin 7, and Pin 8. If the sleep feature is not required, Pin 3 should be connected to  $V_S$ .



Figure 21. Basic Voltage Reference Connections

### MEMBRANE SWITCH-CONTROLLED POWER SUPPLY

With output load currents in the tens of mA, the REF19x family of references can operate as a low dropout power supply in hand-held instrument applications. In the circuit shown in Figure 22, a membrane on/off switch is used to control the operation of the reference. During an initial power-on condition, the SLEEP pin is held to GND by the 10 k $\Omega$  resistor. Recall that this condition (read: three-state) disables the REF19x output. When the membrane on switch is pressed, the SLEEP pin is momentarily pulled to  $V_S$ , enabling the REF19x output. At this point, current through the 10 k $\Omega$  resistor is reduced and the internal current source connected to the SLEEP pin takes control. Pin 3 assumes and remains at the same potential as  $V_S$ . When the membrane off switch is pressed, the SLEEP pin is momentarily connected to GND, which once again disables the REF19x output.



Figure 22. Membrane Switch Controlled Power Supply



Figure 23. Classification Profile (Not to Scale)

**SOLDER HEAT EFFECT**

The mechanical stress and heat effect of soldering a part to a PCB can cause output voltage of a reference to shift in value. The output voltage of REF195 shifts after the part undergoes the extreme heat of a lead-free soldering profile, like the one shown in Figure 23. The materials that make up a semiconductor device and its package have different rates of expansion and contraction. The stress on the dice has changed position, causing shift on the output voltage, after exposed to extreme soldering temperatures. This shift is similar but more severe than thermal hysteresis.

Typical result of soldering temperature effect on REF19x output value shift is shown in Figure 24. It shows the output shift due to soldering and does not include mechanical stress.



Figure 24. Output Shift due to Solder Heat Effect

**CURRENT-BOOSTED REFERENCES WITH CURRENT LIMITING**

Whereas the 30 mA rated output current of the REF19x series is higher than is typical of other reference ICs, it can be boosted to higher levels, if desired, with the addition of a simple external PNP transistor, as shown in Figure 25. Full-time current limiting is used to protect the pass transistor against shorts.



Figure 25. Boosted 3.3 V Referenced with Current Limiting

In this circuit, the power supply current of reference U1 flowing through R1 to R2 develops a base drive for Q1, whose collector provides the bulk of the output current. With a typical gain of 100 in Q1 for 100 mA to 200 mA loads, U1 is never required to furnish more than a few mA, so this factor minimizes temperature-related drift. Short-circuit protection is provided by Q2, which clamps the drive to Q1 at about 300 mA of load current, with values as shown in Figure 25. With this separation of control and power functions, dc stability is optimum, allowing most advantageous use of premium grade REF19x devices for U1. Of course, load

management should still be exercised. A short, heavy, low dc resistance (DCR) conductor should be used from U1 to 6 to the  $V_{OUT}$  Sense Point S, where the collector of Q1 connects to the load, Point F.

Because of the current limiting configuration, the dropout voltage circuit is raised about 1.1 V over that of the REF19x devices, due to the  $V_{BE}$  of Q1 and the drop across Current Sense Resistor R4. However, overall dropout is typically still low enough to allow operation of a 5 V to 3.3 V regulator/reference using the REF196 for U1 as noted, with a  $V_S$  as low as 4.5 V and a load current of 150 mA.

The requirement for a heat sink on Q1 depends on the maximum input voltage and short-circuit current. With  $V_S = 5$  V and a 300 mA current limit, the worst-case dissipation of Q1 is 1.5 W, less than the TO-220 package 2 W limit. However, if smaller TO-39 or TO-5 package devices, such as the 2N4033, are used, the current limit should be reduced to keep maximum dissipation below the package rating. This is accomplished by simply raising R4.

A tantalum output capacitor is used at C1 for its low equivalent series resistance (ESR), and the higher value is required for stability. Capacitor C2 provides input bypassing and can be an ordinary electrolytic.

Shutdown control of the booster stage is an option, and when used, some cautions are needed. Due to the additional active devices in the  $V_S$  line to U1, a direct drive to Pin 3 does not work as with an unbuffered REF19x device. To enable shutdown control, the connection from U1 to Q2 is broken at the X, and Diode D1 then allows a CMOS control source,  $V_C$ , to drive U1 to 3 for on/off operation. Startup from shutdown is not as clean under heavy load as it is in basic REF19x series, and can require several milliseconds under load. Nevertheless, it is still effective and can fully control 150 mA loads. When shutdown control is used, heavy capacitive loads should be minimized.

## NEGATIVE PRECISION REFERENCE WITHOUT PRECISION RESISTORS

In many current-output CMOS DAC applications where the output signal voltage must be the same polarity as the reference voltage, it is often necessary to reconfigure a current-switching DAC into a voltage-switching DAC using a 1.25 V reference, an op amp, and a pair of resistors. Using a current-switching DAC directly requires an additional operational amplifier at the output to invert the signal. A negative voltage reference is then desirable because an additional operational amplifier is not required for either reinversion (current-switching mode) or amplification (voltage-switching mode) of the DAC output voltage. In general, any positive voltage reference can be converted into a negative voltage reference using an operational amplifier and a pair of matched resistors in an inverting configuration. The disadvantage to this approach is that the largest single source of error in the circuit is the relative matching of the resistors used.

The circuit illustrated in Figure 26 avoids the need for tightly matched resistors by using an active integrator circuit. In this circuit, the output of the voltage reference provides the input drive for the integrator. To maintain circuit equilibrium, the

integrator adjusts its output to establish the proper relationship between the  $V_{OUT}$  and GND references. Thus, any desired negative output voltage can be selected by substituting for the appropriate reference IC. The sleep feature is maintained in the circuit with the simple addition of a PNP transistor and a 10 k $\Omega$  resistor.



Figure 26. Negative Precision Voltage Reference Uses No Precision Resistors

One caveat to this approach is that although rail-to-rail output amplifiers work best in the application, these operational amplifiers require a finite amount (mV) of headroom when required to provide any load current; consider this issue when choosing the negative supply for the circuit.

## STACKING REFERENCE ICs FOR ARBITRARY OUTPUTS

Some applications may require two reference voltage sources that are a combined sum of standard outputs. The circuit in Figure 27 shows how this stacked output reference can be implemented.

Two reference ICs are used, fed from a common unregulated input,  $V_S$ . The outputs of the individual ICs are connected in series, as shown in Figure 27, which provide two output voltages,  $V_{OUT1}$  and  $V_{OUT2}$ .  $V_{OUT1}$  is the terminal voltage of U1, whereas  $V_{OUT2}$  is the sum of this voltage and the terminal voltage of U2. U1 and U2 are chosen for the two voltages that supply the required outputs (see Table 1). If, for example, both U1 and U2 are REF192s, the two outputs are 2.5 V and 5.0 V.

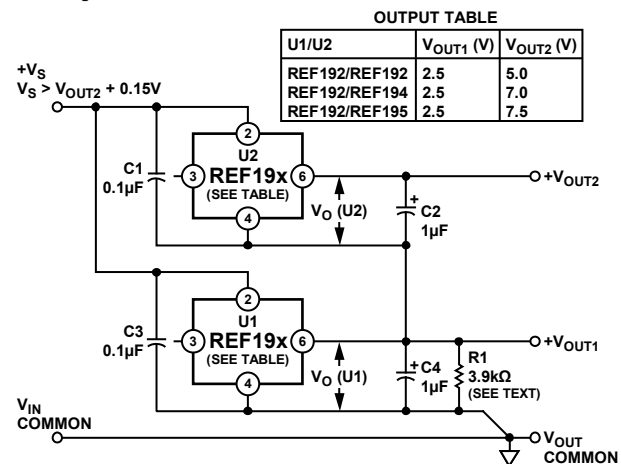

Figure 27. Stacking Voltage References with the REF19x



Using dissimilar REF19x series devices with this configuration allows logic selection between the U1/U2-specified terminal voltages. For example, with U1 (a REF195) and U2 (a REF196), as noted in the table in Figure 30, changing the CMOS-compatible  $V_C$  logic control voltage from high to low selects between a nominal output of 5.0 V and 3.3 V, and vice versa. Other REF19x family units can also be used for U1/U2, with similar operation in a logic sense, but with outputs as per the individual paired devices (see the table in Figure 30). Of course, the exact output voltage tolerance, drift, and overall quality of the reference voltage is consistent with the grade of individual U1 and U2 devices.

Due to the nature of the wire-OR, one application caveat should be understood about this circuit. Because U1 and U2 can only source current effectively, negative going output voltage changes, which require the sinking of current, necessarily take longer than positive going changes. In practice, this means that the circuit is quite fast when undergoing a transition from 3.3 V to 5 V, but the transition from 5 V to 3.3 V takes longer. Exactly how much longer is a function of the load resistance,  $R_L$ , seen at the output and the typical 1  $\mu$ F value of C2. In general, a conservative transition time is approximately several milliseconds for load resistances in the range of 100  $\Omega$  to 1 k $\Omega$ . Note that for highest accuracy at the new output voltage, several time constants should be allowed (for example, >7.6 time constants for <1/2 LSB error @ 10 bits).

## KELVIN CONNECTIONS

In many portable applications where the PCB cost and area go hand-in-hand, circuit interconnects are very often narrow. These narrow lines can cause large voltage drops if the voltage reference is required to provide load currents to various functions. The interconnections of a circuit can exhibit a typical line resistance of 0.45 m $\Omega$ /square (for example, 1 oz. Cu).

In applications where these devices are configured as low dropout voltage regulators, these wiring voltage drops can become a large source of error. To circumvent this problem, force and sense connections can be made to the reference through the use of an operational amplifier, as shown in Figure 31. This method provides a means by which the effects of wiring resistance voltage drops can be eliminated. Load currents flowing through wiring resistance produce an I-R error ( $I_{LOAD} \times R_{WIRE}$ ) at the load. However, the Kelvin connection overcomes the problem by including the wiring resistance within the forcing loop of the op amp. Because the op amp senses the load voltage, op amp loop control forces the output to compensate for the wiring error and to produce the correct voltage at the load. Depending on the reference device chosen, operational amplifiers that can be used in this application are the OP295, OP292, and OP183.



Figure 31. Low Dropout, Kelvin-Connected Voltage Reference

## FAIL-SAFE 5 V REFERENCE

Some critical applications require a reference voltage to be maintained at a constant voltage, even with a loss of primary power. The low standby power of the REF19x series and the switched output capability allow a fail-safe reference configuration to be implemented rather easily. This reference maintains a tight output voltage tolerance for either a primary power source (ac line derived) or a standby (battery derived) power source, automatically switching between the two as the power conditions change.

The circuit in Figure 32 illustrates this concept, which borrows from the switched output idea of Figure 30, again using the REF19x device family output wire-OR capability. In this case, because a constant 5 V reference voltage is desired for all conditions, two REF195 devices are used for U1 and U2, with their on/off switching controlled by the presence or absence of the primary dc supply source,  $V_S$ .  $V_{BAT}$  is a 6 V battery backup source that supplies power to the load only when  $V_S$  fails. For normal ( $V_S$  present) power conditions,  $V_{BAT}$  sees only the 15  $\mu$ A (maximum) standby current drain of U1 in its off state.

In operation, it is assumed that for all conditions, either U1 or U2 is on, and a 5 V reference output is available. With this voltage constant, a scaled down version is applied to the Comparator IC U3, providing a fixed 0.5 V input to the negative input for all power conditions. The R1 to R2 divider provides a signal to the U3 positive input proportionally to  $V_S$ , which switches U3 and U1/U2, dependent upon the absolute level of  $V_S$ . In Figure 32, Op Amp U3 is configured as a comparator with hysteresis, which provides clean, noise-free output switching. This hysteresis is important to eliminate rapid switching at the threshold due to  $V_S$  ripple. Furthermore, the device chosen is the AD820, a rail-to-rail output device. This device provides high and low output states within a few mV of  $V_S$ , ground for accurate thresholds, and compatible drive for U2 for all  $V_S$  conditions. R3 provides positive feedback for circuit hysteresis, changing the threshold at the positive input as a function of the output of U3.



Figure 32. Fail-Safe 5 V Reference

For  $V_S$  levels lower than the lower threshold, the output of U3 is low, thus U2 and Q1 are off and U1 is on. For  $V_S$  levels higher than the upper threshold, the situation reverses, with U1 off and both U2 and Q1 on. In the interest of battery power conservation, all of the comparison switching circuitry is powered from  $V_S$  and is arranged so that when  $V_S$  fails, the default output comes from U1.

For the R1 to R3 values, as shown in Figure 32, lower/upper  $V_S$  switching thresholds are approximately 5.5 V and 6 V, respectively. These can be changed to suit other  $V_S$  supplies, as can the REF19x devices used for U1 and U2, over a range of 2.5 V to 5 V of output. U3 can operate down to a  $V_S$  of 3.3 V, which is generally compatible with all REF19x family devices.

**LOW POWER, STRAIN GAGE CIRCUIT**

As shown in Figure 33, the REF19x family of references can be used in conjunction with low supply voltage operational amplifiers, such as the OP492 or the OP747, in a self-contained strain gage circuit in which the REF195 is used as the core. Other references can be easily accommodated by changing circuit element values. The references play a dual role, first as the voltage regulator to provide the supply voltage requirements of the strain gage and the operational amplifiers, and second as a precision voltage reference for the current source used to stimulate the bridge. A distinct feature of the circuit is that it can be remotely controlled on or off by digital means via the SLEEP pin.



Figure 33. Low Power, Strain Gage Circuit

OUTLINE DIMENSIONS



COMPLIANT TO JEDEC STANDARDS MS-001  
 CONTROLLING DIMENSIONS ARE IN INCHES; MILLIMETER DIMENSIONS  
 (IN PARENTHESES) ARE ROUNDED-OFF INCH EQUIVALENTS FOR  
 REFERENCE ONLY AND ARE NOT APPROPRIATE FOR USE IN DESIGN.  
 CORNER LEADS MAY BE CONFIGURED AS WHOLE OR HALF LEADS.

Figure 34. 8-Lead Plastic Dual In-Line Package [PDIP]  
 P-Suffix (N-8)

Dimensions shown in inches and (millimeters)

070606-A



COMPLIANT TO JEDEC STANDARDS MO-153-AA

Figure 35. 8-Lead Thin Shrink Small Outline Package [TSSOP]  
 (RU-8)

Dimensions shown in millimeters



COMPLIANT TO JEDEC STANDARDS MS-012-AA  
 CONTROLLING DIMENSIONS ARE IN MILLIMETERS; INCH DIMENSIONS  
 (IN PARENTHESES) ARE ROUNDED-OFF MILLIMETER EQUIVALENTS FOR  
 REFERENCE ONLY AND ARE NOT APPROPRIATE FOR USE IN DESIGN.

Figure 36. 8-Lead Standard Small Outline Package [SOIC\_N]

Narrow Body  
 S-Suffix (R-8)

Dimensions shown in millimeters and (inches)

## ORDERING GUIDE

| Model <sup>1</sup> | Temperature Range | Package Description | Package Option | Ordering Quantity |
|--------------------|-------------------|---------------------|----------------|-------------------|
| REF191ES           | -40°C to +85°C    | 8-Lead SOIC_N       | S-Suffix (R-8) |                   |
| REF191ES-REEL      | -40°C to +85°C    | 8-Lead SOIC_N       | S-Suffix (R-8) | 2,500             |
| REF191ESZ          | -40°C to +85°C    | 8-Lead SOIC_N       | S-Suffix (R-8) |                   |
| REF191ESZ-REEL     | -40°C to +85°C    | 8-Lead SOIC_N       | S-Suffix (R-8) | 2,500             |
| REF191GS           | -40°C to +85°C    | 8-Lead SOIC_N       | S-Suffix (R-8) |                   |
| REF191GS-REEL      | -40°C to +85°C    | 8-Lead SOIC_N       | S-Suffix (R-8) | 2,500             |
| REF191GSZ          | -40°C to +85°C    | 8-Lead SOIC_N       | S-Suffix (R-8) |                   |
| REF191GSZ-REEL     | -40°C to +85°C    | 8-Lead SOIC_N       | S-Suffix (R-8) | 2,500             |
| REF192ES           | -40°C to +85°C    | 8-Lead SOIC_N       | S-Suffix (R-8) |                   |
| REF192ES-REEL      | -40°C to +85°C    | 8-Lead SOIC_N       | S-Suffix (R-8) | 2,500             |
| REF192ES-REEL7     | -40°C to +85°C    | 8-Lead SOIC_N       | S-Suffix (R-8) | 1,000             |
| REF192ESZ          | -40°C to +85°C    | 8-Lead SOIC_N       | S-Suffix (R-8) |                   |
| REF192ESZ-REEL     | -40°C to +85°C    | 8-Lead SOIC_N       | S-Suffix (R-8) | 2,500             |
| REF192ESZ-REEL7    | -40°C to +85°C    | 8-Lead SOIC_N       | S-Suffix (R-8) | 1,000             |
| REF192FS           | -40°C to +85°C    | 8-Lead SOIC_N       | S-Suffix (R-8) |                   |
| REF192FS-REEL      | -40°C to +85°C    | 8-Lead SOIC_N       | S-Suffix (R-8) | 2,500             |
| REF192FS-REEL7     | -40°C to +85°C    | 8-Lead SOIC_N       | S-Suffix (R-8) | 1,000             |
| REF192FSZ          | -40°C to +85°C    | 8-Lead SOIC_N       | S-Suffix (R-8) |                   |
| REF192FSZ-REEL     | -40°C to +85°C    | 8-Lead SOIC_N       | S-Suffix (R-8) | 2,500             |
| REF192FSZ-REEL7    | -40°C to +85°C    | 8-Lead SOIC_N       | S-Suffix (R-8) | 1,000             |
| REF192GPZ          | -40°C to +85°C    | 8-Lead PDIP         | P-Suffix (N-8) |                   |
| REF192GRUZ         | -40°C to +85°C    | 8-Lead TSSOP        | RU-8           |                   |
| REF192GRUZ-REEL7   | -40°C to +85°C    | 8-Lead TSSOP        | RU-8           | 1,000             |
| REF192GS           | -40°C to +85°C    | 8-Lead SOIC_N       | S-Suffix (R-8) |                   |
| REF192GS-REEL      | -40°C to +85°C    | 8-Lead SOIC_N       | S-Suffix (R-8) | 2,500             |
| REF192GS-REEL7     | -40°C to +85°C    | 8-Lead SOIC_N       | S-Suffix (R-8) | 1,000             |
| REF192GSZ          | -40°C to +85°C    | 8-Lead SOIC_N       | S-Suffix (R-8) |                   |
| REF192GSZ-REEL     | -40°C to +85°C    | 8-Lead SOIC_N       | S-Suffix (R-8) | 2,500             |
| REF192GSZ-REEL7    | -40°C to +85°C    | 8-Lead SOIC_N       | S-Suffix (R-8) | 1,000             |
| REF193GSZ          | -40°C to +85°C    | 8-Lead SOIC_N       | S-Suffix (R-8) |                   |
| REF193GSZ-REEL     | -40°C to +85°C    | 8-Lead SOIC_N       | S-Suffix (R-8) | 2,500             |
| REF194ES           | -40°C to +85°C    | 8-Lead SOIC_N       | S-Suffix (R-8) |                   |
| REF194ESZ          | -40°C to +85°C    | 8-Lead SOIC_N       | S-Suffix (R-8) |                   |
| REF194ESZ-REEL     | -40°C to +85°C    | 8-Lead SOIC_N       | S-Suffix (R-8) | 2,500             |
| REF194GS-REEL      | -40°C to +85°C    | 8-Lead SOIC_N       | S-Suffix (R-8) | 2,500             |
| REF194GS-REEL7     | -40°C to +85°C    | 8-Lead SOIC_N       | S-Suffix (R-8) | 1,000             |
| REF194GSZ          | -40°C to +85°C    | 8-Lead SOIC_N       | S-Suffix (R-8) |                   |
| REF194GSZ-REEL     | -40°C to +85°C    | 8-Lead SOIC_N       | S-Suffix (R-8) | 2,500             |
| REF194GSZ-REEL7    | -40°C to +85°C    | 8-Lead SOIC_N       | S-Suffix (R-8) | 1,000             |
| REF195ES           | -40°C to +85°C    | 8-Lead SOIC_N       | S-Suffix (R-8) |                   |
| REF195ES-REEL      | -40°C to +85°C    | 8-Lead SOIC_N       | S-Suffix (R-8) | 2,500             |
| REF195ESZ          | -40°C to +85°C    | 8-Lead SOIC_N       | S-Suffix (R-8) |                   |
| REF195ESZ-REEL     | -40°C to +85°C    | 8-Lead SOIC_N       | S-Suffix (R-8) | 2,500             |
| REF195FS           | -40°C to +85°C    | 8-Lead SOIC_N       | S-Suffix (R-8) |                   |
| REF195FS-REEL      | -40°C to +85°C    | 8-Lead SOIC_N       | S-Suffix (R-8) | 2,500             |
| REF195FSZ          | -40°C to +85°C    | 8-Lead SOIC_N       | S-Suffix (R-8) |                   |
| REF195FSZ-REEL     | -40°C to +85°C    | 8-Lead SOIC_N       | S-Suffix (R-8) | 2,500             |
| REF195GPZ          | -40°C to +85°C    | 8-Lead PDIP         | P-Suffix (N-8) |                   |
| REF195GRU-REEL7    | -40°C to +85°C    | 8-Lead TSSOP        | RU-8           | 1,000             |
| REF195GRUZ         | -40°C to +85°C    | 8-Lead TSSOP        | RU-8           |                   |
| REF195GRUZ-REEL7   | -40°C to +85°C    | 8-Lead TSSOP        | RU-8           | 1,000             |

| Model <sup>1</sup> | Temperature Range | Package Description | Package Option | Ordering Quantity |
|--------------------|-------------------|---------------------|----------------|-------------------|
| REF195GS           | -40°C to +85°C    | 8-Lead SOIC_N       | S-Suffix (R-8) |                   |
| REF195GS-REEL      | -40°C to +85°C    | 8-Lead SOIC_N       | S-Suffix (R-8) | 2,500             |
| REF195GS-REEL7     | -40°C to +85°C    | 8-Lead SOIC_N       | S-Suffix (R-8) | 1,000             |
| REF195GSZ          | -40°C to +85°C    | 8-Lead SOIC_N       | S-Suffix (R-8) |                   |
| REF195GSZ-REEL     | -40°C to +85°C    | 8-Lead SOIC_N       | S-Suffix (R-8) | 2,500             |
| REF195GSZ-REEL7    | -40°C to +85°C    | 8-Lead SOIC_N       | S-Suffix (R-8) | 1,000             |
| REF196GRUZ-REEL7   | -40°C to +85°C    | 8-Lead TSSOP        | RU-8           | 1,000             |
| REF196GSZ          | -40°C to +85°C    | 8-Lead SOIC_N       | S-Suffix (R-8) |                   |
| REF196GSZ-REEL     | -40°C to +85°C    | 8-Lead SOIC_N       | S-Suffix (R-8) | 2,500             |
| REF196GSZ-REEL7    | -40°C to +85°C    | 8-Lead SOIC_N       | S-Suffix (R-8) | 1,000             |
| REF198ES           | -40°C to +85°C    | 8-Lead SOIC_N       | S-Suffix (R-8) |                   |
| REF198ES-REEL      | -40°C to +85°C    | 8-Lead SOIC_N       | S-Suffix (R-8) | 2,500             |
| REF198ESZ          | -40°C to +85°C    | 8-Lead SOIC_N       | S-Suffix (R-8) |                   |
| REF198ESZ-REEL     | -40°C to +85°C    | 8-Lead SOIC_N       | S-Suffix (R-8) | 2,500             |
| REF198ESZ-REEL7    | -40°C to +85°C    | 8-Lead SOIC_N       | S-Suffix (R-8) | 1,000             |
| REF198FS-REEL      | -40°C to +85°C    | 8-Lead SOIC_N       | S-Suffix (R-8) | 2,500             |
| REF198FSZ          | -40°C to +85°C    | 8-Lead SOIC_N       | S-Suffix (R-8) |                   |
| REF198FSZ-REEL     | -40°C to +85°C    | 8-Lead SOIC_N       | S-Suffix (R-8) | 2,500             |
| REF198GRUZ         | -40°C to +85°C    | 8-Lead TSSOP        | RU-8           |                   |
| REF198GRUZ-REEL7   | -40°C to +85°C    | 8-Lead TSSOP        | RU-8           | 2,500             |
| REF198GS           | -40°C to +85°C    | 8-Lead SOIC_N       | S-Suffix (R-8) |                   |
| REF198GS-REEL      | -40°C to +85°C    | 8-Lead SOIC_N       | S-Suffix (R-8) | 2,500             |
| REF198GSZ          | -40°C to +85°C    | 8-Lead SOIC_N       | S-Suffix (R-8) |                   |
| REF198GSZ-REEL     | -40°C to +85°C    | 8-Lead SOIC_N       | S-Suffix (R-8) | 2,500             |

<sup>1</sup> Z = RoHS Compliant Part.

## Looking for pricing, stock, or lifecycle information?

Click below to explore more details on WIN SOURCE:

 [View REF191GS-REEL on WIN SOURCE](#)

 [Analog Devices Inc. Information](#)

## Optimize Your Supply Chain with WIN SOURCE Solutions

-  Global Sourcing Solution
-  Obsolete Management
-  Cost Control Management
-  Shortage Management
-  Alternative Solution
-  Excess Inventory Management