



**THE DATASHEET OF
NCS211RSQT2G**



Current-Shunt Monitors, Voltage Output, Bidirectional, Zero-Drift, Low- or High-Side Current Sensing

NCS210R, NCV210R, NCS211R, NCV211R, NCS213R, NCV213R, NCS214R, NCV214R

The NCS210R, NCS211R, NCS213R and NCS214R are voltage output, current shunt monitors (also called current sense amplifiers) which can measure voltage across shunts at common-mode voltages from -0.3 V to 26 V , independent of supply voltage. The low offset of the zero-drift architecture enables current sensing across the shunt with maximum voltage drop as low as 10 mV full-scale. These devices can operate from a single $+2.2\text{ V}$ to $+26\text{ V}$ power supply, drawing a maximum of $80\text{ }\mu\text{A}$ of supply current, and are specified over the extended operating temperature range (-40°C to $+125^{\circ}\text{C}$). Available in the SC70-6 and UQFN10 packages.

Features

- Wide Common Mode Input Range: -0.3 V to 26 V
- Supply Voltage Range: 2.2 V to 26 V
- Low Offset Voltage: $\pm 35\text{ }\mu\text{V}$ max
- Low Offset Drift: $\pm 0.5\text{ }\mu\text{V}/^{\circ}\text{C}$
- Low Gain Error: $\pm 1\%$ max
- Low Gain Error Drift: $\pm 10\text{ ppm}/^{\circ}\text{C}$ max
- Rail-to-Rail Output Capability
- Low Current Consumption: $40\text{ }\mu\text{A}$ typ, $80\text{ }\mu\text{A}$ max
- NCV Prefix for Automotive and Other Applications Requiring Unique Site Qualified and PPAP Capable

Typical Applications

- Current Sensing (High-Side/Low-Side)
- Automotive
- Telecom
- Power Management
- Battery Charging and Discharging

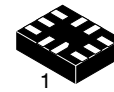

UQFN10
MU SUFFIX
CASE 488AT

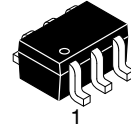

SC70-6
SQ SUFFIX
CASE 419B

MARKING DIAGRAM

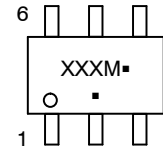
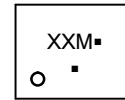

XXX = Specific Device Code
M = Date Code
▪ = Pb-Free Package
(Note: Microdot may be in either location)

PIN CONNECTIONS

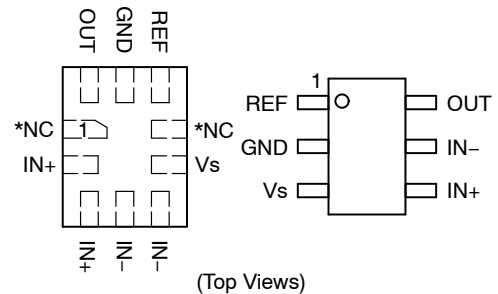

*NC denotes no internal connection. These pins can be left floating or connected to any voltage between V_S and GND.

ORDERING INFORMATION

See detailed ordering, marking and shipping information on page 2 of this data sheet.

NCS210R, NCV210R, NCS211R, NCV211R, NCS213R, NCV213R, NCS214R, NCV214R

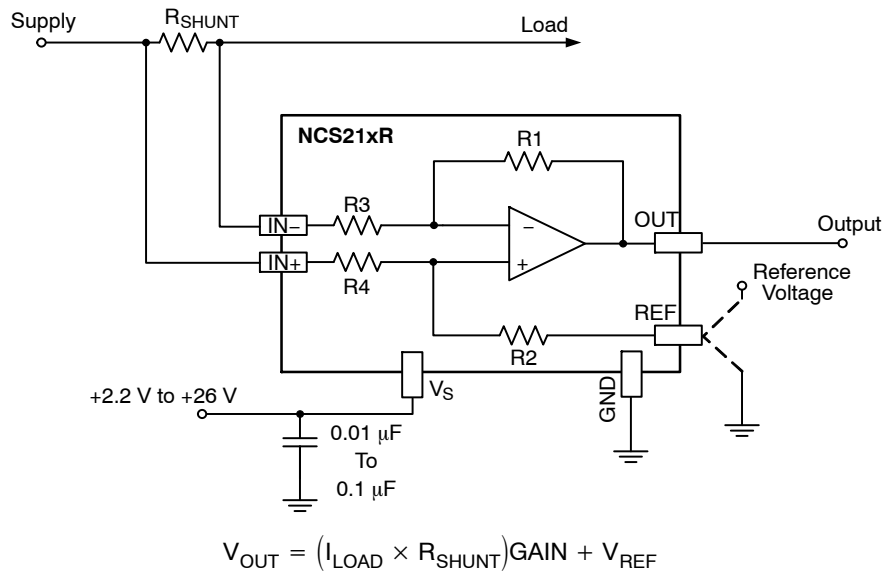

Figure 1. Example Application Schematic of High-Side Current Sensing

ORDERING INFORMATION

| Device | Gain | R3 and R4 | R1 and R2 | Marking | Package | Shipping† |
|---------------|------|-----------|-----------|---------|---------|----------------------|
| NCS210RSQT2G | 200 | 5 kΩ | 1 MΩ | AVY | SC70-6 | 3000 / Tape and Reel |
| NCV210RSQT2G* | 200 | 5 kΩ | 1 MΩ | AVY | SC70-6 | 3000 / Tape and Reel |
| NCS210RMUTAG | 200 | 5 kΩ | 1 MΩ | CP | UQFN10 | 3000 / Tape and Reel |
| NCS211RSQT2G | 500 | 2 kΩ | 1 MΩ | AVZ | SC70-6 | 3000 / Tape and Reel |
| NCV211RSQT2G* | 500 | 2 kΩ | 1 MΩ | AVZ | SC70-6 | 3000 / Tape and Reel |
| NCS213RSQT2G | 50 | 20 kΩ | 1 MΩ | AV3 | SC70-6 | 3000 / Tape and Reel |
| NCV213RSQT2G* | 50 | 20 kΩ | 1 MΩ | AV3 | SC70-6 | 3000 / Tape and Reel |
| NCS214RSQT2G | 100 | 10 kΩ | 1 MΩ | AV4 | SC70-6 | 3000 / Tape and Reel |
| NCV214RSQT2G* | 100 | 10 kΩ | 1 MΩ | AV4 | SC70-6 | 3000 / Tape and Reel |
| NCS214RMUTAG | 100 | 10 kΩ | 1 MΩ | CR | UQFN10 | 3000 / Tape and Reel |
| NCS211RMUTAG | 500 | 2 kΩ | 1 MΩ | CM | UQFN10 | 3000 / Tape and Reel |
| NCS213RMUTAG | 50 | 20 kΩ | 1 MΩ | CQ | UQFN10 | 3000 / Tape and Reel |

†For information on tape and reel specifications, including part orientation and tape sizes, please refer to our Tape and Reel Packaging Specifications Brochure, BRD8011/D.

*NCV Prefix for Automotive and Other Applications Requiring Unique Site and Control Change Requirements; AEC-Q100 Qualified and PPAP Capable.

Table 1. MAXIMUM RATINGS

| Parameter | | Symbol | Value | Unit |
|---|--|--------------------|------------------------------|------|
| Supply Voltage (Note 1) | | V_S | +30 | V |
| Analog Input Voltage | Differential (V_{IN+})-(V _{IN-}) | V_{IN+}, V_{IN-} | -30 to +30 | V |
| | Common-Mode (Note 2) | | (GND-0.3) to +30 | |
| REF Pin Input Voltage | | V_{REF} | (GND-0.3) to ($V_S + 0.3$) | V |
| Output Voltage (Note 2) | | V_{OUT} | (GND-0.3) to ($V_S + 0.3$) | V |
| Input Current into Any Pin (Note 2) | | | ±5 | mA |
| Maximum Junction Temperature | | $T_{J(max)}$ | +150 | °C |
| Storage Temperature Range | | T_{STG} | -65 to +150 | °C |
| ESD Capability, Human Body Model (Note 3) | | HBM | ±2000 | V |
| Charged Device Model (Note 3) | | CDM | ±2000 | V |
| Latch-Up Current (Note 4) | | I_{LU} | ±100 | mA |

Stresses exceeding those listed in the Maximum Ratings table may damage the device. If any of these limits are exceeded, device functionality should not be assumed, damage may occur and reliability may be affected.

1. Refer to ELECTRICAL CHARACTERISTICS, RECOMMENDED OPERATING RANGES and/or APPLICATION INFORMATION for safe operating parameters.
2. Input voltage at any pin may exceed the voltage shown if current at that pin is limited to ±5 mA.
3. This device series incorporates ESD protection and is tested by the following methods:
 ESD Human Body Model tested per JEDEC standard JS-001-2017 (AEC-Q100-002).
 ESD Charged Device Model tested per JEDEC standard JS-002-2014 (AEC-Q100-011).
4. Latch-up Current tested per JEDEC standard JESD78E (AEC-Q100-004)

Table 2. RECOMMENDED OPERATING RANGES

| Parameter | Symbol | Min | Typ | Max | Unit |
|---------------------------|----------|------|-----|-----|------|
| Common Mode Input Voltage | V_{CM} | -0.3 | 12 | 26 | V |
| Supply Voltage | V_S | 2.2 | 5 | 26 | V |
| Ambient Temperature | T_A | -40 | | 125 | °C |

Functional operation above the stresses listed in the Recommended Operating Ranges is not implied. Extended exposure to stresses beyond the Recommended Operating Ranges limits may affect device reliability.

Table 3. THERMAL CHARACTERISTICS (Note 5)

| Package | θ_{JA} Junction-to-Ambient Thermal Resistance (Note 6) | Ψ_{JT} Junction-to-Case Top Thermal Characteristic | Ψ_{JB} Junction-to-Board Thermal Characteristic | Unit |
|---------|---|---|--|------|
| UQFN10 | 115 | 4 | 43 | °C/W |
| SC70-6 | 180 | 42 | 84 | |

5. Refer to ELECTRICAL CHARACTERISTICS, RECOMMENDED OPERATING RANGES and/or APPLICATION INFORMATION for safe operating parameters.
6. Following JEDEC JESD51-7, thermal parameters are based on a 2s2p board with 1 oz copper planes and 400 mm² heat spreader area

NCS210R, NCV210R, NCS211R, NCV211R, NCS213R, NCV213R, NCS214R, NCV214R

Table 4. ELECTRICAL CHARACTERISTICS At $T_A = +25^\circ\text{C}$, $V_{\text{SENSE}} = V_{\text{IN}+} - V_{\text{IN}-}$;

NCS210R, NCS213R and NCS214R: $V_S = +5\text{ V}$, $V_{\text{IN}+} = 12\text{ V}$, and $V_{\text{REF}} = V_S/2$, unless otherwise noted.

NCS211R: $V_S = +12\text{ V}$, $V_{\text{IN}+} = 12\text{ V}$, and $V_{\text{REF}} = V_S/2$, unless otherwise noted.

Boldface limits apply over the specified temperature range of $T_A = -40^\circ\text{C}$ to 125°C , guaranteed by characterization and/or design.

| Symbol | Parameter | Test Conditions | Min | Typ | Max | Unit | | |
|---------------------|--|---------------------------------|---|-----|------------|-----------------------------|------------------------------|-----------|
| INPUT | | | | | | | | |
| V_{CM} | Common-Mode Input Voltage Range | | -0.3 | | 26 | V | | |
| CMRR | Common-Mode Rejection Ratio (Note 7) | NCx210R, NCx211R, NCx214R | $V_{\text{IN}+} = 0\text{ V to }+26\text{ V}$, $V_{\text{SENSE}} = 0\text{ mV}$ $T_A = -40^\circ\text{C to }125^\circ\text{C}$ | 125 | | dB | | |
| | | NCx213R | | | | | 100 | |
| V_{OS} | Input Offset Voltage (Note 7) | NCx210R, NCx211R | $V_{\text{SENSE}} = 0\text{ mV}$ | | ± 0.55 | ± 35 | | |
| | | NCx213R | | | | | ± 5 | ± 100 |
| | | NCx214R | | | | | ± 1 | ± 60 |
| dV_{OS}/dT | Input Offset Voltage Drift over Temperature (Note 7) | NCx21xR | $V_{\text{SENSE}} = 0\text{ mV}$ $T_A = -40^\circ\text{C to }+125^\circ\text{C}$ | | ± 0.1 | ± 0.5 | $\mu\text{V}/^\circ\text{C}$ | |
| PSRR | Power Supply Rejection Ratio, RTI (Note 7) | | $V_S = +2.7\text{ V to }+26\text{ V}$, $V_{\text{IN}+} = 18\text{ V}$, $V_{\text{SENSE}} = 0\text{ mV}$ | | ± 0.1 | ± 10 | $\mu\text{V}/\text{V}$ | |
| I_{IB} | Input Bias Current | | $V_{\text{SENSE}} = 0\text{ mV}$ | | ± 39 | ± 60 | μA | |
| I_{IO} | Input Offset Current | | $V_{\text{SENSE}} = 0\text{ mV}$ | | ± 0.1 | | μA | |

OUTPUT

| | | | | | | | |
|-------|---------------------------|---------|--|--|------------|----------------------------|-----------------------|
| G | Gain | NCx210R | | | 200 | | V/V |
| | | NCx211R | | | 500 | | |
| | | NCx213R | | | 50 | | |
| | | NCx214R | | | 100 | | |
| E_G | Gain Error | NCx21xR | $V_{\text{SENSE}} = -5\text{ mV to }5\text{ mV}$, $T_A = -40^\circ\text{C to }125^\circ\text{C}$ | | ± 0.2 | ± 1 | % |
| E_G | Gain Error vs Temperature | NCx21xR | $T_A = -40^\circ\text{C to }125^\circ\text{C}$ | | ± 3 | ± 10 | ppm/ $^\circ\text{C}$ |
| | Nonlinearity Error | | $V_{\text{SENSE}} = -5\text{ mV to }5\text{ mV}$ | | ± 0.01 | | % |
| C_L | Maximum Capacitive Load | | No sustained oscillation | | 1 | | nF |

VOLTAGE OUTPUT

| | | | | | | |
|-----------------|----------------------------------|--|--|--------------------------|---|---|
| V_{OH} | Swing to V_S Power Supply Rail | $R_L = 10\text{ k}\Omega$ to GND $T_A = -40^\circ\text{C to }+125^\circ\text{C}$ (Note 8) | | $V_S - 0.075$ | $V_S - 0.2$ | V |
| V_{OL} | Swing to GND | $R_L = 10\text{ k}\Omega$ to GND $T_A = -40^\circ\text{C to }+125^\circ\text{C}$ | | $V_{\text{GND}} + 0.005$ | $V_{\text{GND}} + 0.05$ | V |

FREQUENCY RESPONSE

| | | | | | | | |
|----|---------------------------------|---------|----------------------------------|--|----|--|------------------|
| BW | Bandwidth ($f_{-3\text{dB}}$) | NCx210R | $C_{\text{LOAD}} = 10\text{ pF}$ | | 40 | | kHz |
| | | NCx211R | | | 25 | | |
| | | NCx213R | | | 90 | | |
| | | NCx214R | | | 60 | | |
| SR | Slew Rate | | | | 1 | | V/ μs |

NOISE

| | | | | | | |
|-------|--------------------------------|--------------------|--|----|--|------------------------------|
| e_n | Voltage Noise Density (Note 7) | $f = 1\text{ kHz}$ | | 45 | | $\text{nV}/\sqrt{\text{Hz}}$ |
|-------|--------------------------------|--------------------|--|----|--|------------------------------|

POWER SUPPLY

| | | | | | | |
|-------|------------------------------------|---|------------|----|------------|---------------|
| V_S | Operating Voltage Range | $T_A = -40^\circ\text{C to }+125^\circ\text{C}$ | 2.2 | | 26 | V |
| I_Q | Quiescent Current | $V_{\text{SENSE}} = 0\text{ mV}$ | | 40 | 80 | μA |
| | Quiescent Current over Temperature | $T_A = -40^\circ\text{C to }+125^\circ\text{C}$ | | | 100 | μA |

7. RTI = referenced-to-input

8. $V_S = 5\text{ V}$ for NCx211R

Product parametric performance is indicated in the Electrical Characteristics for the listed test conditions, unless otherwise noted. Product performance may not be indicated by the Electrical Characteristics if operated under different conditions.

TYPICAL CHARACTERISTICS ($T_A = 25^\circ\text{C}$, $V_S = 5\text{ V}$, $V_{IN+} = 12\text{ V}$ and $V_{REF} = V_S/2$ unless otherwise noted.)
 (The NCS210R is used for Typical Characteristics)

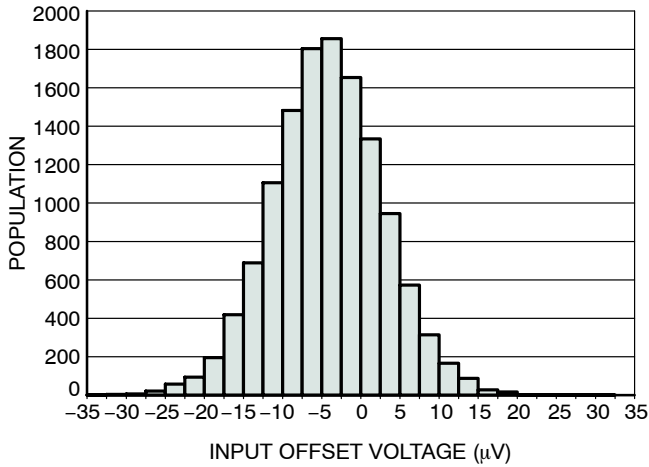

Figure 2. Input Offset Voltage Production Distribution

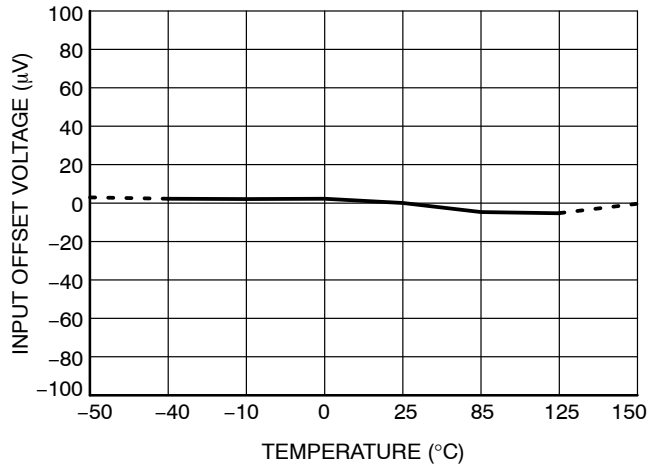

Figure 3. Input Offset Voltage vs. Temperature

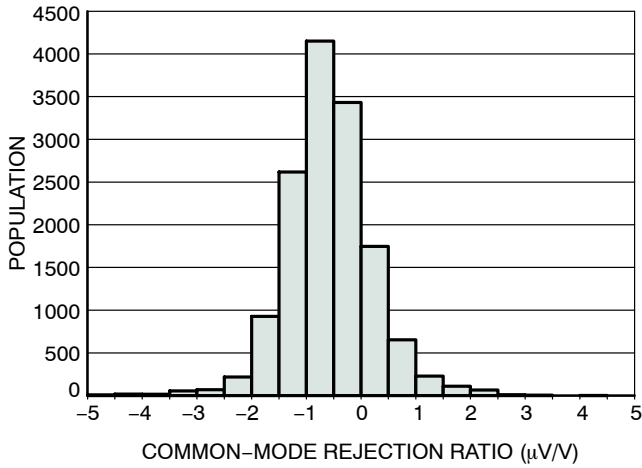

Figure 4. Common-Mode Rejection Production Distribution

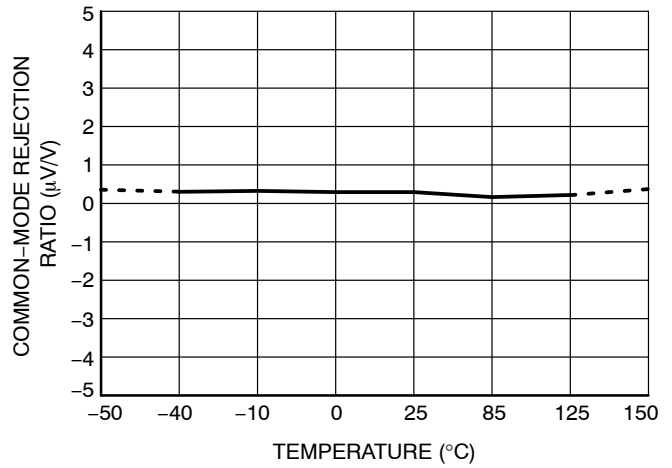

Figure 5. Common-Mode Rejection Ratio vs. Temperature

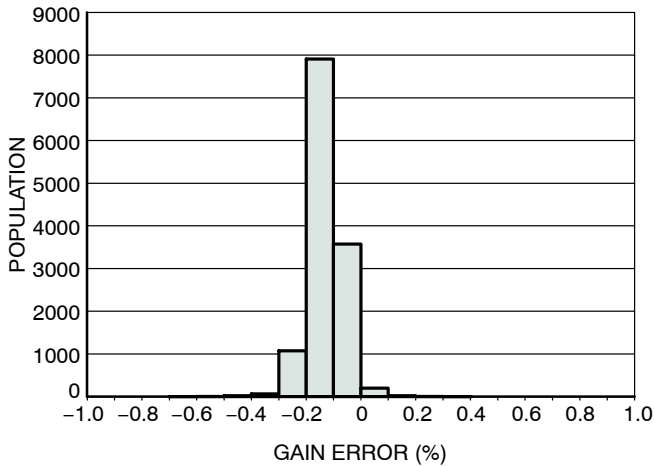

Figure 6. Gain Error Production Distribution

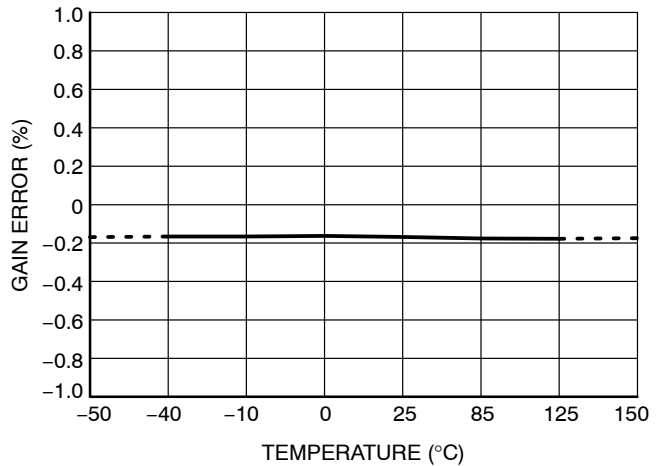

Figure 7. Gain Error vs. Temperature

TYPICAL CHARACTERISTICS ($T_A = 25^\circ\text{C}$, $V_S = 5\text{ V}$, $V_{IN+} = 12\text{ V}$ and $V_{REF} = V_S/2$ unless otherwise noted.)
 (The NCS210R is used for Typical Characteristics)

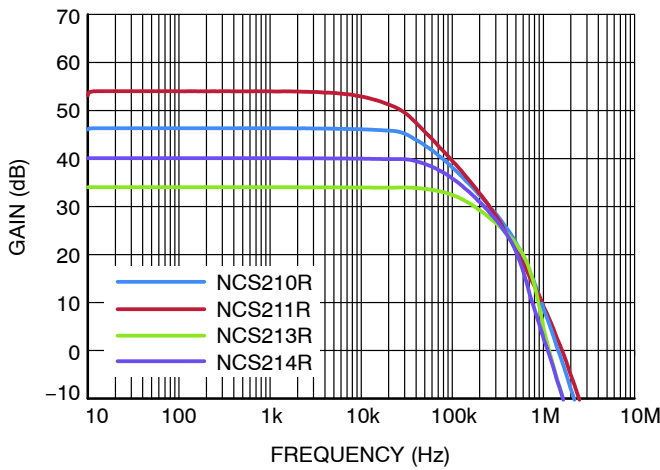

Figure 8. Gain vs. Frequency

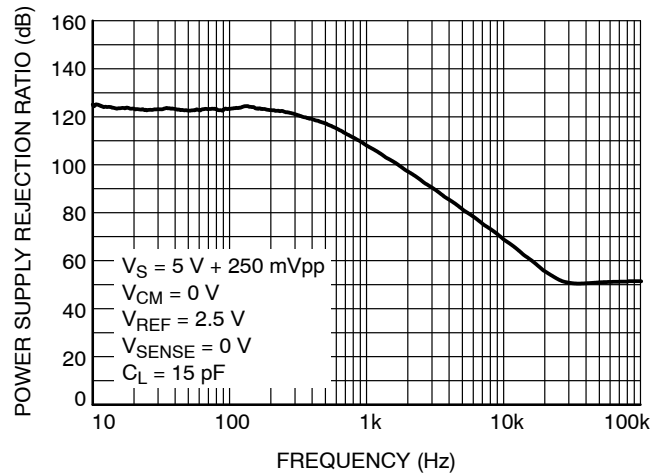

Figure 9. Power Supply Rejection Ratio vs. Frequency

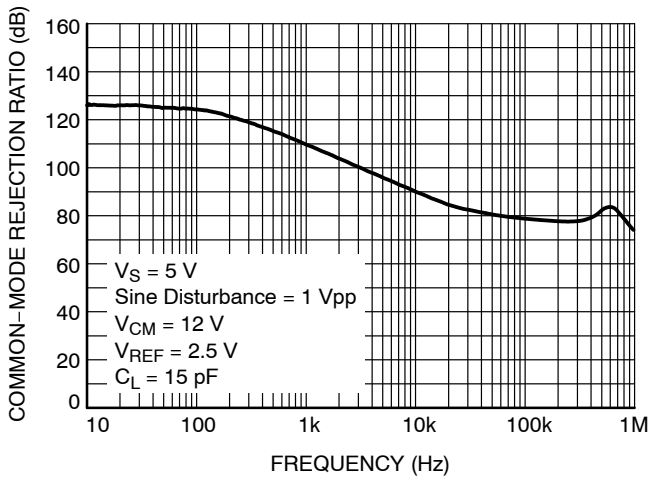

Figure 10. Common-Mode Rejection Ratio vs. Frequency

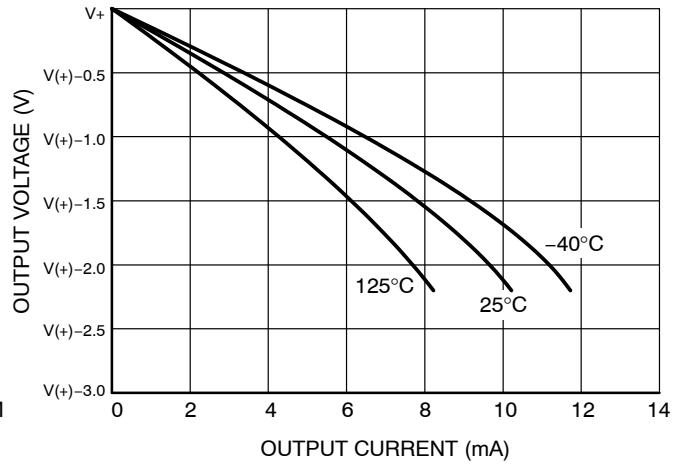

Figure 11. Positive Output Voltage Swing vs. Output Current, $V_S = 2.2\text{ V}$

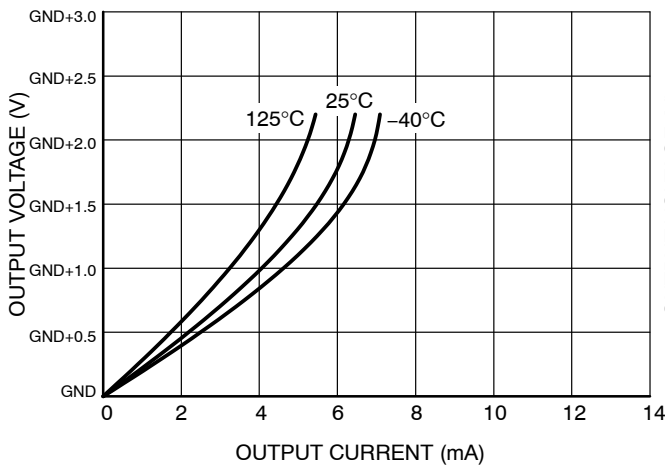

Figure 12. Negative Output Voltage Swing vs. Output Current, $V_S = 2.2\text{ V}$

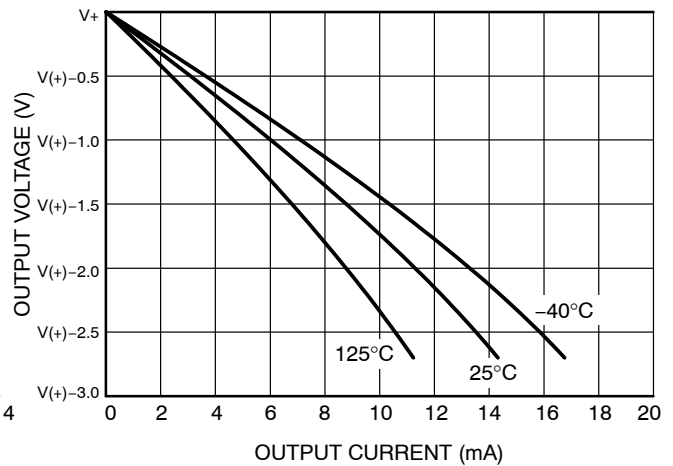

Figure 13. Positive Output Voltage Swing vs. Output Current, $V_S = 2.7\text{ V}$

TYPICAL CHARACTERISTICS ($T_A = 25^\circ\text{C}$, $V_S = 5\text{ V}$, $V_{IN+} = 12\text{ V}$ and $V_{REF} = V_S/2$ unless otherwise noted.)
 (The NCS210R is used for Typical Characteristics)

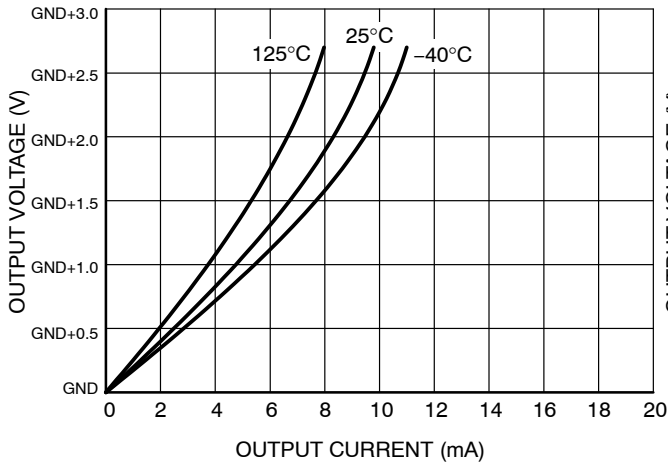

Figure 14. Negative Output Voltage Swing vs. Output Current, $V_S = 2.7\text{ V}$

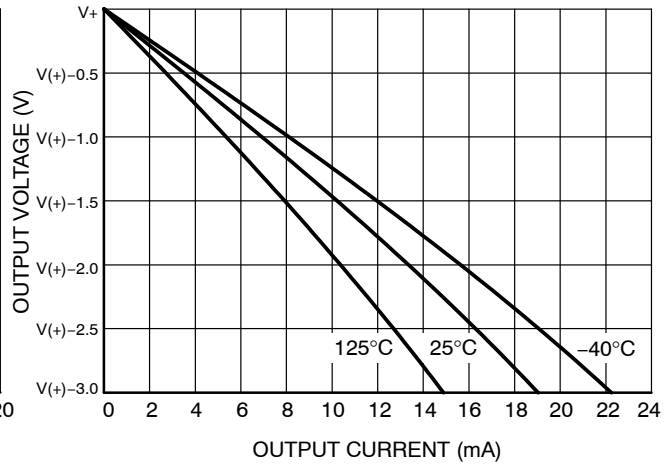

Figure 15. Positive Output Voltage Swing vs. Output Current, $V_S = 5\text{ V}$

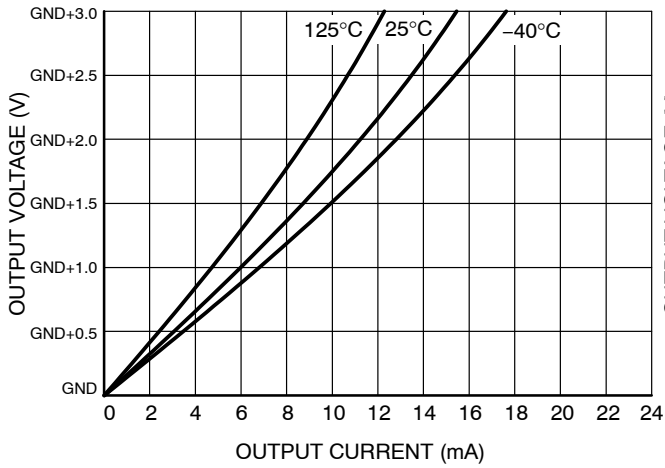

Figure 16. Negative Output Voltage Swing vs. Output Current, $V_S = 5\text{ V}$

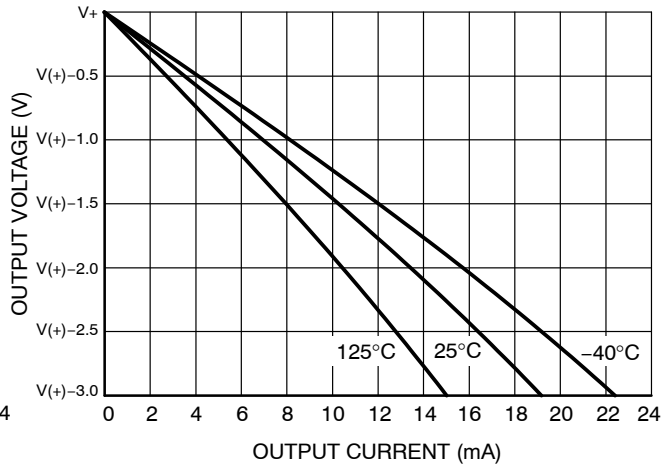

Figure 17. Positive Output Voltage Swing vs. Output Current, $V_S = 26\text{ V}$

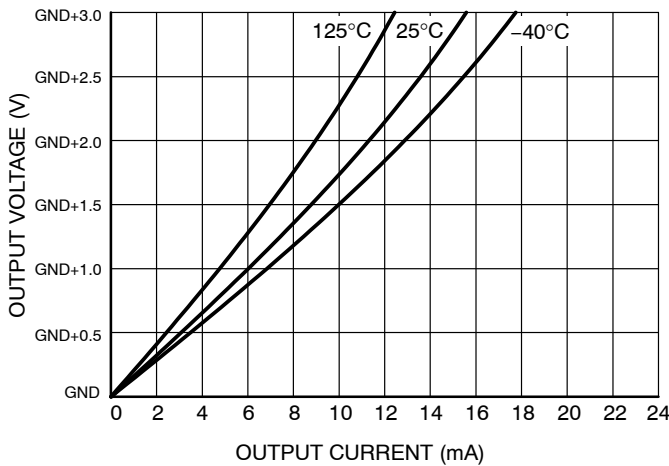

Figure 18. Negative Output Voltage Swing vs. Output Current, $V_S = 26\text{ V}$

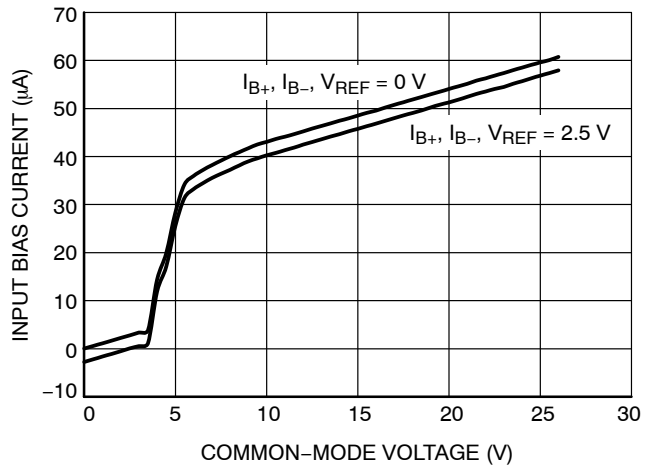

Figure 19. Input Bias Current vs. Common-Mode Voltage with $V_S = 5\text{ V}$

TYPICAL CHARACTERISTICS ($T_A = 25^\circ\text{C}$, $V_S = 5\text{ V}$, $V_{IN+} = 12\text{ V}$ and $V_{REF} = V_S/2$ unless otherwise noted.)
 (The NCS210R is used for Typical Characteristics)

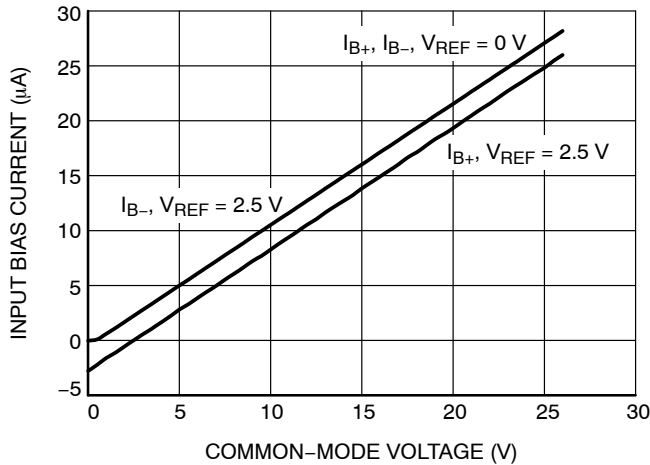

Figure 20. Input Bias Current vs. Common-Mode Voltage with $V_S = 0\text{ V}$ (Shutdown)

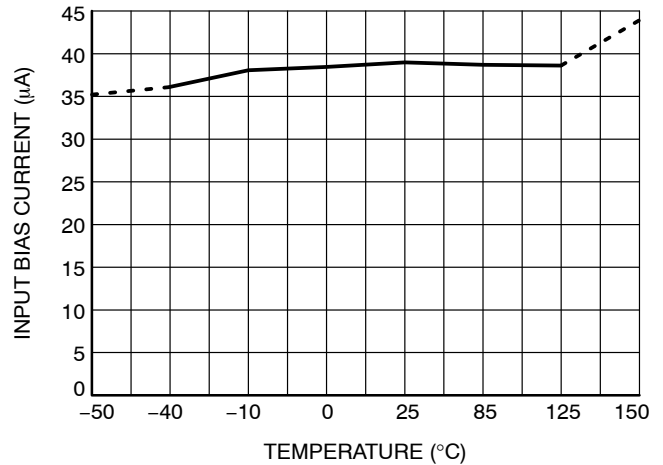

Figure 21. Input Bias Current vs. Temperature

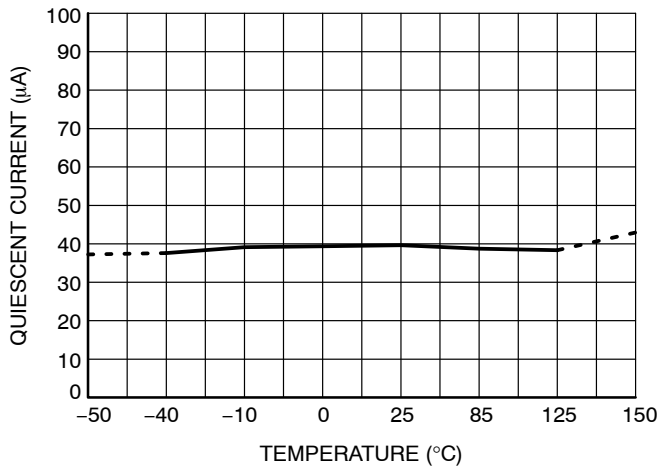

Figure 22. Quiescent Current vs. Temperature

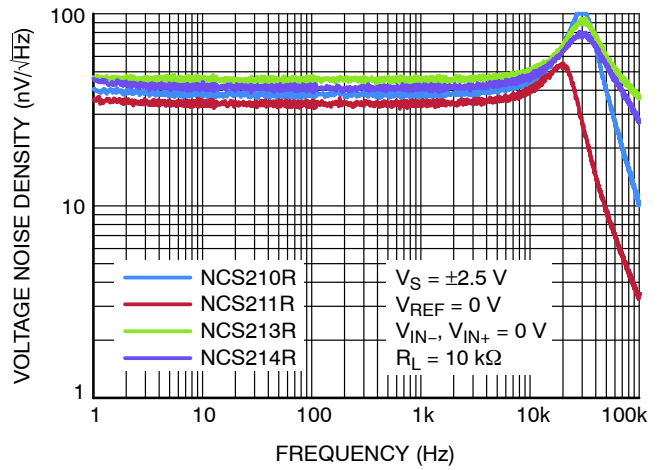

Figure 23. Voltage Noise Density vs. Frequency

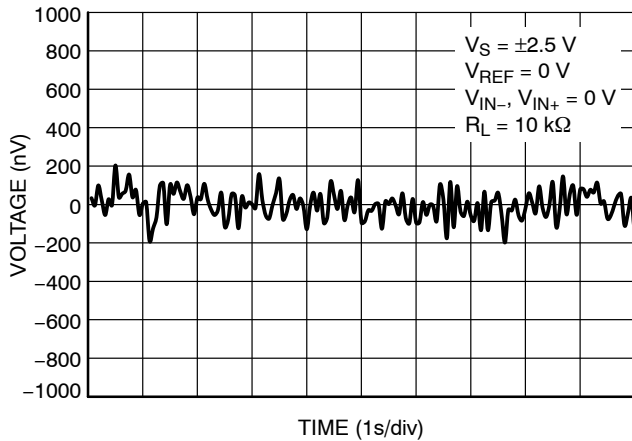

Figure 24. 0.1 Hz to 10 Hz Voltage Noise (Referred to Input)

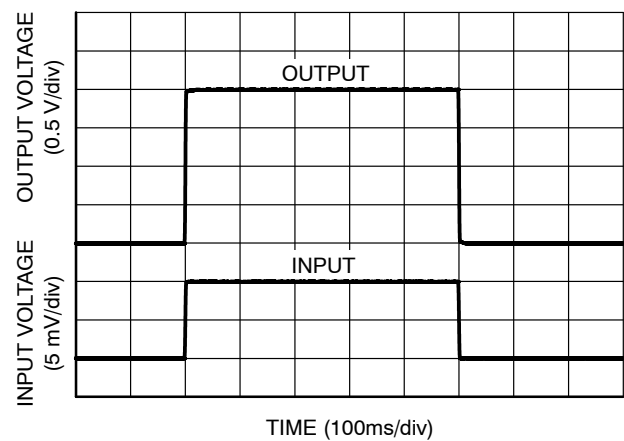

Figure 25. Step Response (10 mVpp Input Step)

TYPICAL CHARACTERISTICS ($T_A = 25^\circ\text{C}$, $V_S = 5\text{ V}$, $V_{IN+} = 12\text{ V}$ and $V_{REF} = V_S/2$ unless otherwise noted.)
 (The NCS210R is used for Typical Characteristics)

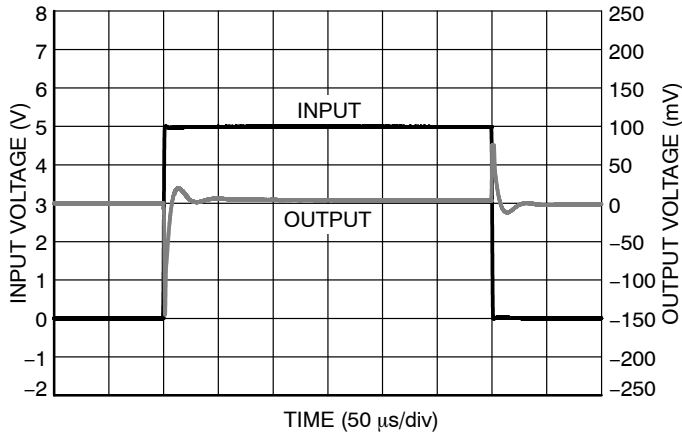

Figure 26. Common-Mode Voltage Transient Response

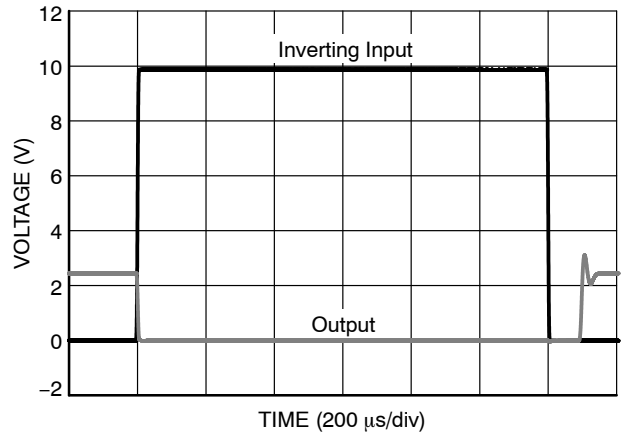

Figure 27. Inverting Differential Input Overload

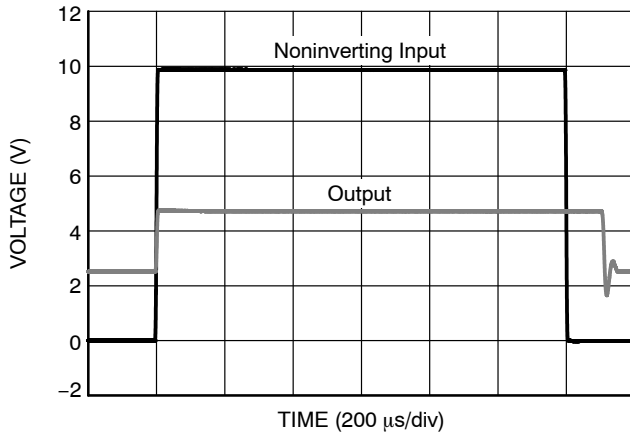

Figure 28. Noninverting Differential Input Overload

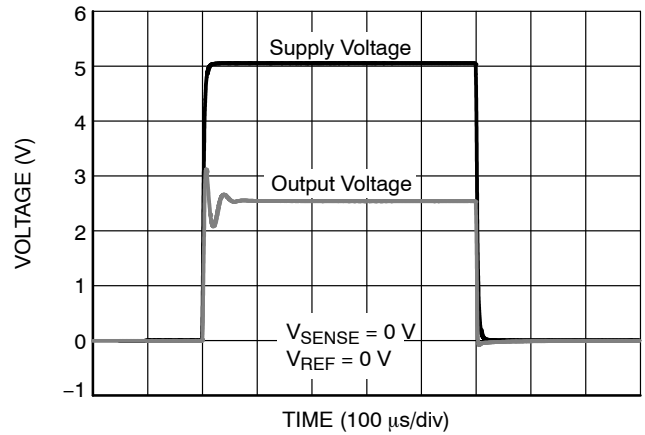

Figure 29. Start-Up Response

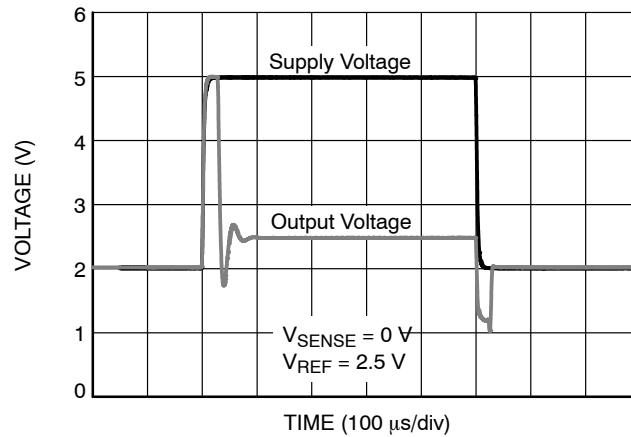

Figure 30. Brownout Recovery

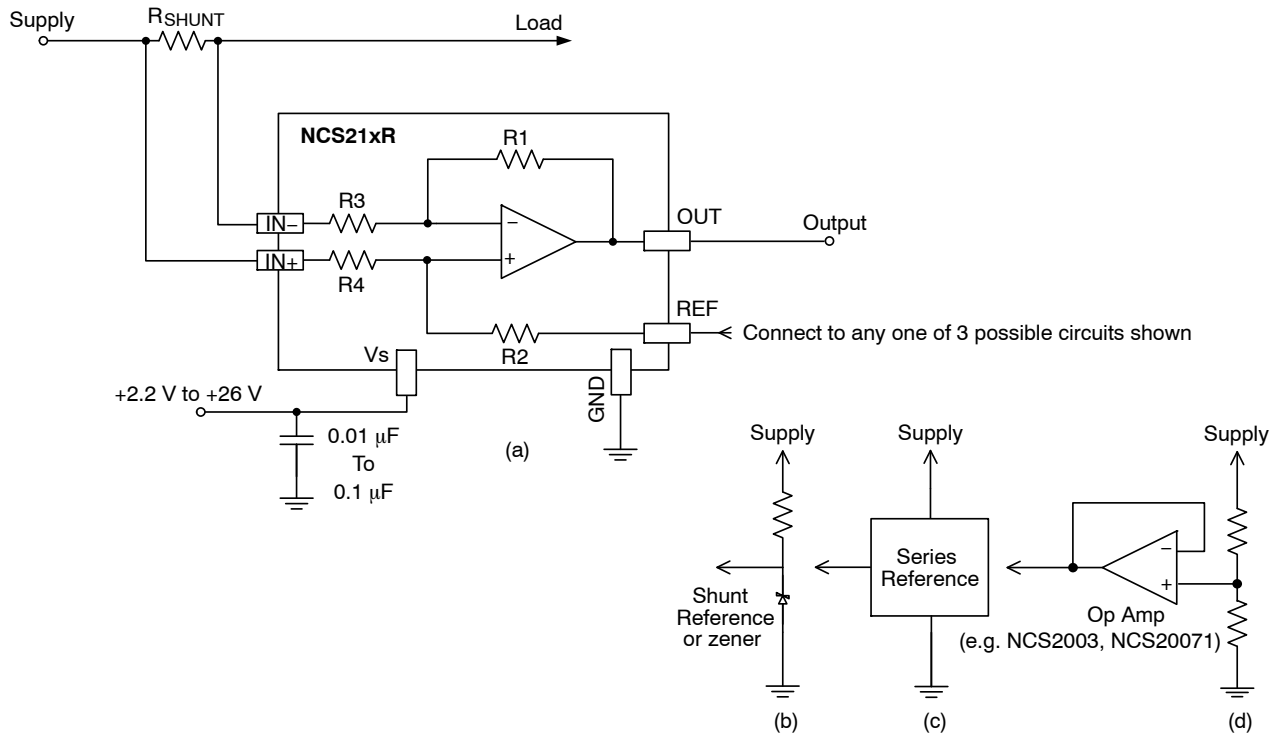

Figure 32. Bidirectional Current Sensing with Three Example Voltage Reference Circuits

The REF pin must always be connected to a low impedance circuit, such as in the Figure 32(b), (c), and (d). The REF pin can be connected directly to any voltage supply or voltage reference (shunt or series). However, if a resistor divider network is used to provide the reference voltage, a unity gain buffer circuit must be used, as shown in Figure 32(d).

In bidirectional applications, any voltage that exceeds $V_S + 0.3$ V applied to the REF pin will forward bias an ESD diode between the REF pin and the V_S pin. Note that this exceeds the Absolute Maximum Ratings for the device.

Input and Output Filtering

Filtering at the input or output may be required for several different reasons. In this section we will discuss the main considerations with regards to these filter circuits.

In some applications, the current being measured may be inherently noisy. In the case of a noisy signal, filtering after the output of the current sense amplifier is often simpler, especially where the amplifier output is fed into high impedance circuitry. The amplifier output node provides the greatest freedom when selecting components for the filter and is very straightforward to implement, although it may require subsequent buffering.

Other applications may require filtering at the input of the current sense amplifier. Figure 33 shows the recommended schematic for input filtering.

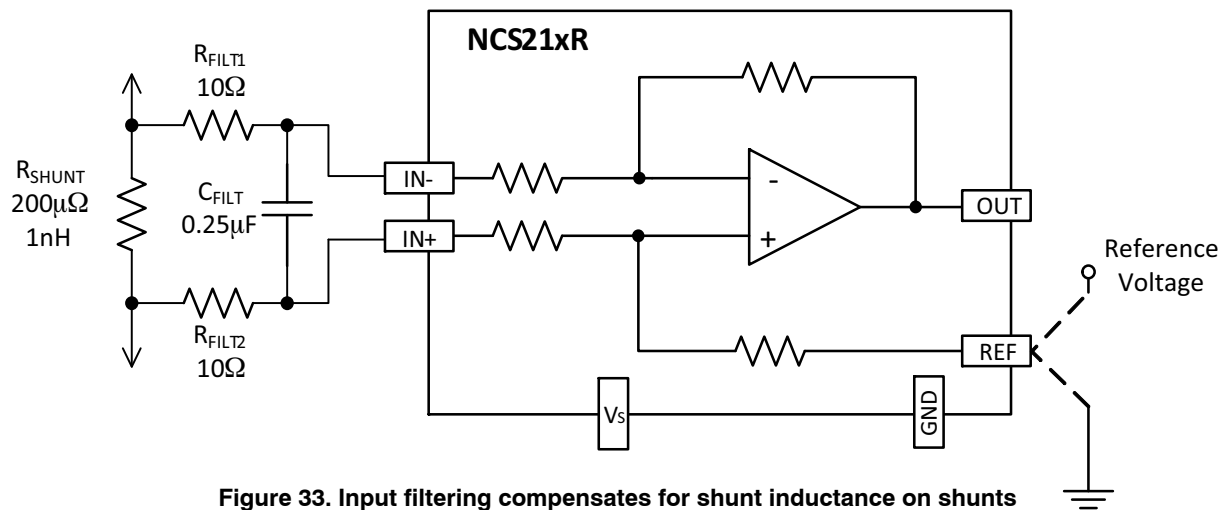

Figure 33. Input filtering compensates for shunt inductance on shunts less than 1 mΩ, as well as high frequency noise in any application

Input filtering is complicated by the fact that the added resistance of the filter resistors and the associated resistance mismatch between them can adversely affect gain, CMRR, and V_{OS} . The effect on V_{OS} is partly due to input bias currents as well. As a result, the value of the input resistors should be limited to 10 Ω or less. Ideally, select the capacitor to exactly match the time constant of the shunt resistor and its inductance; alternatively, select the capacitor to provide a pole below that point. As an example, a filtering frequency of 100 kHz would require an 80 nF capacitor. The capacitor can have a low voltage rating, but should have good high frequency characteristics.

Make the input filter time constant equal to or larger than the shunt and its inductance time constant:

$$\frac{L_{SHUNT}}{R_{SHUNT}} \leq 2 \cdot R_{FILT} \cdot C_{FILT}$$

This simplifies to determine the value of C_{FILT} based on using 10 Ω resistors for each R_{FILT} :

$$C_{FILT} \geq \frac{L_{SHUNT}}{20R_{SHUNT}}$$

If the main purpose is to filter high frequency noise, the capacitor should be increased to a value that provides the desired filtering.

As the shunt resistors decrease in value, shunt inductance can significantly affect frequency response. At values below 1 mΩ, the shunt inductance causes a zero in the transfer function that often results in corner frequencies in the low 100's of kHz. This inductance increases the amplitude of

high frequency spike transient events on the current sensing line that can overload the front end of any shunt current sensing IC. This problem must be solved by filtering at the input of the amplifier. Note that all current sensing IC's are vulnerable to this problem, regardless of manufacturer claims. Filtering is required at the input of the device to resolve this problem, even if the spike frequencies are above the rated bandwidth of the device.

Advantages When Used for Low-Side Current Sensing

The NCS21xR series offer many advantages for low-side current sensing. The true differential input is ideal for connection to either Kelvin Sensing shunts or conventional shunts. Additionally, the true differential input rejects the common-mode noise often present even in low-side current sensing. The NCS21xR also provides a reference pin to set the output offset from an external reference. Providing all of these features in a tiny package makes the NCS21xR very competitive when compared to discrete op amp solutions.

Designing for Input Transients Exceeding 30 Volts

For applications that have transient common-mode voltages greater than 30 volts, external input resistors of 10 Ω provide a convenient location to add either Zener diodes or transient voltage suppression diodes (also known as TVS diodes). There are two possible configurations: one using a single TVS diode with diodes across the amplifier inputs as shown in Figure 34, and the second configuration using two TVS diodes as shown in Figure 35.

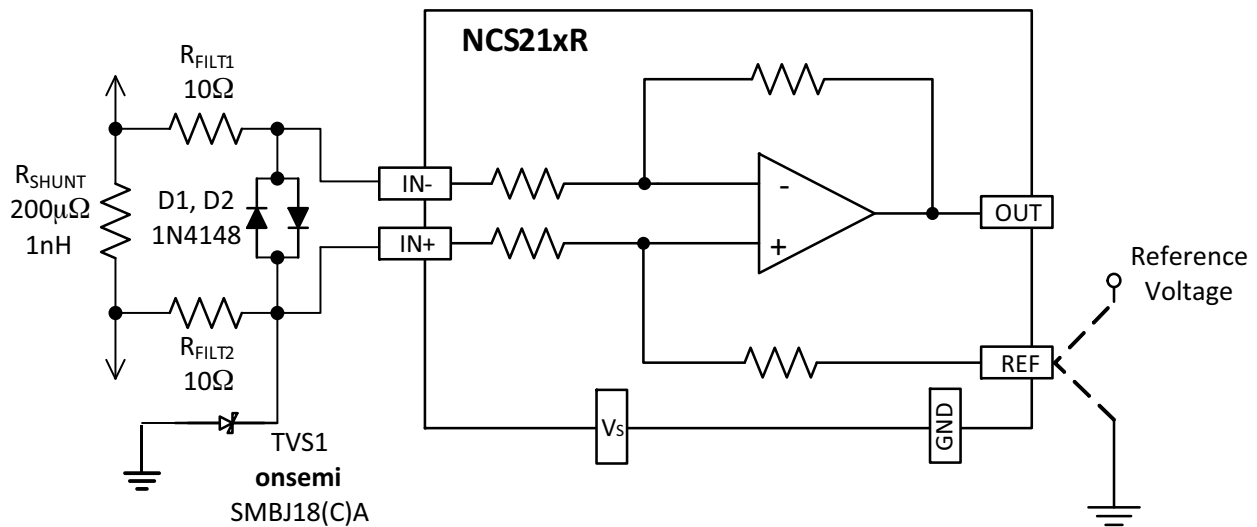

Figure 34. Single TVS transient common-mode protection

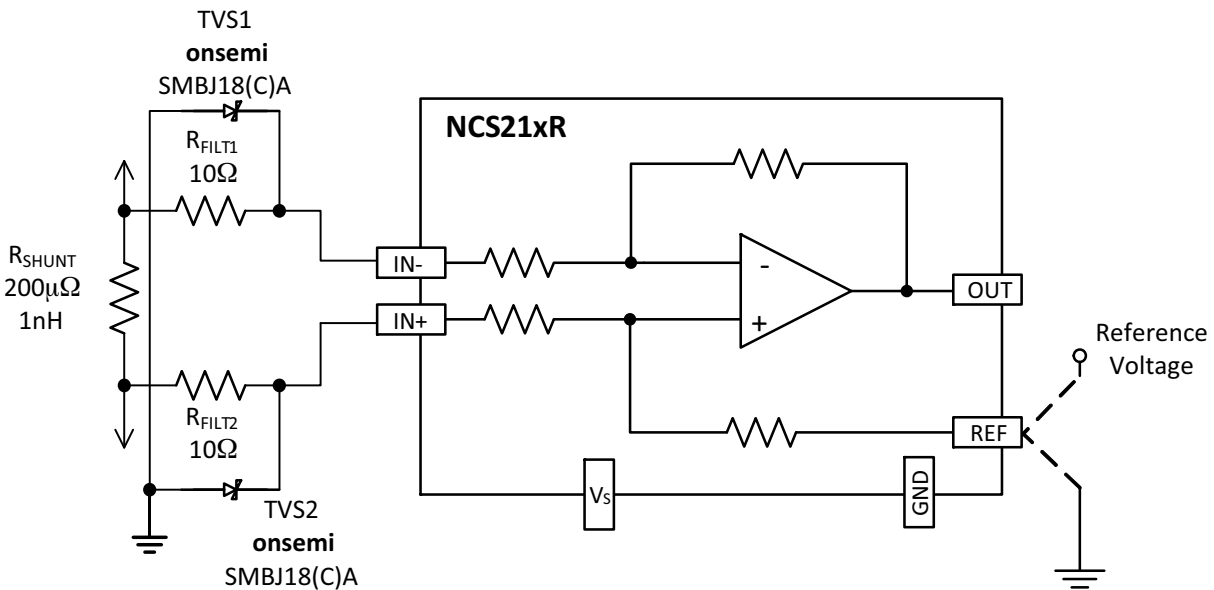

Figure 35. Dual TVS Transient Common-mode Protection

Use Zener diodes or unidirectional TVS diodes with clamping voltage ratings up to a maximum of 30 volts. Select TVS diodes with the lowest voltage rating possible for use in the system. There is a wide range between standoff voltage and maximum clamping voltage in TVS diodes. Most diodes rated at a standoff voltage of 18 V have a maximum clamping voltage of 29.2 V. Refer to the TVS data sheet and the parameters of your power supply to make the selection. In general, higher power TVS diodes demonstrate a sharper clamping knee; providing a tighter relationship between rated breakdown and maximum clamping voltage.

Selecting the Shunt Resistor

The desired accuracy of the current measurement determines the precision, shunt size, and the resistor value. The larger the resistor value, the more accurate the measurement possible, but a large resistor value also results in greater current loss.

For the most accurate measurements, use four terminal current sense resistors, as shown in Figure 36. It provides two terminals for the current path in the application circuit, and a second pair for the voltage detection path of the sense amplifier. This technique is also known as *Kelvin Sensing*. This insures that the voltage measured by the sense amplifier is the actual voltage across the resistor and does not include the small resistance of a combined connection. When using non-Kelvin shunts, follow manufacturer recommendations on how to lay out the sensing traces closely.



Figure 36. Surface Mount Kelvin Shunt

Current Output Configuration

In applications where the readout boards are remotely located, the voltage output of the NCS21xR can be converted to a precision current output. The precision output current measurements are read more accurately as it overcomes the errors due to ground drops between the boards.

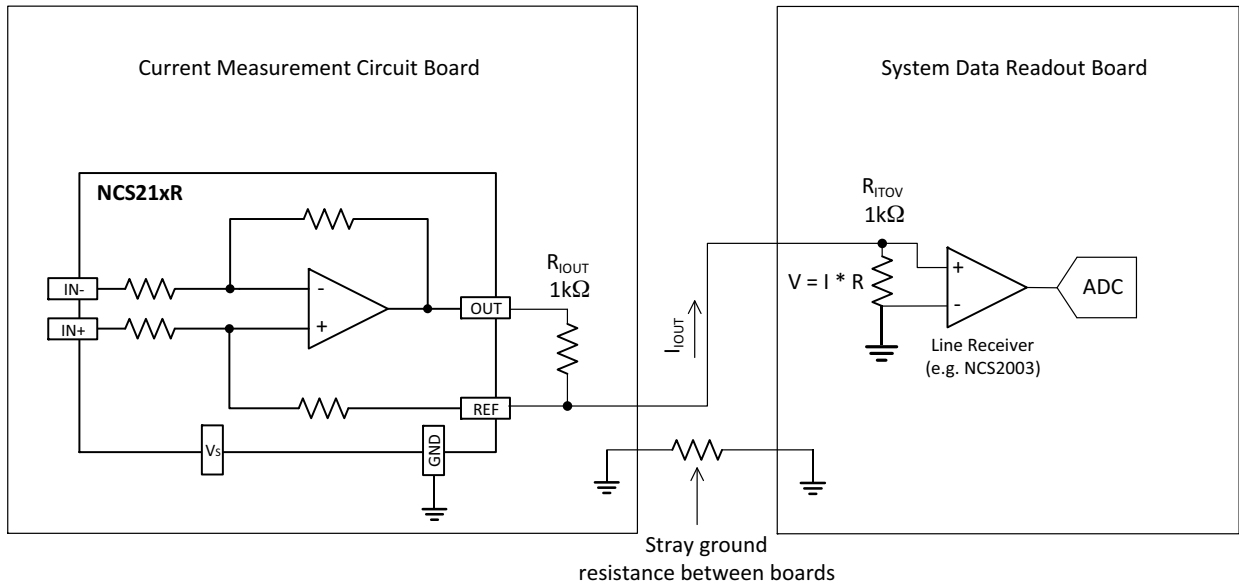

Figure 37. Remote Current Sensing

As shown in Figure 37, the R_{IOUT} resistor is added between the OUT pin and the REF pin to convert the voltage output to a current output which is taken from the REF pin to the readout board. This circuit is intended to function with low potentials between the boards due to ground drops or noise. The current output is simply the relationship of the normal output voltage of the NCS21xR:

$$I_{OUT} = \frac{V_{OUT}}{R_{IOUT}}$$

A resistor value of 1 kΩ for R_{IOUT} is always a convenient value as it provides 1 mA/V scaling.

On the readout board, for simplicity, R_{ITOV} can be equal to R_{IOUT} to provide identical voltage drops across both. It is important to take into consideration that R_{ITOV} and R_{IOUT} add additional voltage drops in the current measurement path. The current source can provide enough compliance to

overcome most ground voltage drop, stray voltages, and noise. However, accuracy will degrade if noise or ground drops exceed 1 V.

Shutting Down the NCS21xR

While the NCS21xR does not provide a shutdown pin, a simple MOSFET, power switch, or logic gate can be used to switch off the power to the NCS21xR and eliminate the quiescent current. Note that the shunt input pins will always have a current flow via the input and feedback resistors (total resistance of each leg always equals slightly higher than 1 MΩ). Also note that when powered, the shunt input pins will exhibit the specified and well-matched typical bias current of 39 μA. The shunt input pins support the rated common mode voltage even when the NCS21xR does not have power applied.

MECHANICAL CASE OUTLINE PACKAGE DIMENSIONS



SC-88 2.00x1.25x0.90, 0.65P
CASE 419B-02
ISSUE Z

DATE 18 APR 2024

NOTES:

1. DIMENSIONING AND TOLERANCING CONFORM TO ASME Y14.5-2018.
2. ALL DIMENSION ARE IN MILLIMETERS.
3. DIMENSIONS D AND E1 DO NOT INCLUDE MOLD FLASH, PROTRUSIONS, OR GATE BURRS. MOLD FLASH, PROTRUSIONS, OR GATE BURRS SHALL NOT EXCEED 0.20 PER END.
4. DIMENSIONS D AND E1 AT THE OUTERMOST EXTREMES OF THE PLASTIC BODY AND DATUM H.
5. DATUMS A AND B ARE DETERMINED AT DATUM H.
6. DIMENSIONS b AND c APPLY TO THE FLAT SECTION OF THE LEAD BETWEEN 0.08 AND 0.15 FROM THE TIP.
7. DIMENSION b DOES NOT INCLUDE DAMBAR PROTRUSION. ALLOWABLE DAMBAR PROTRUSION SHALL BE 0.08 TOTAL IN EXCESS OF DIMENSION b AT MAXIMUM MATERIAL CONDITION. THE DAMBAR CANNOT BE LOCATED ON THE LOWER RADIUS OF THE FOOT.

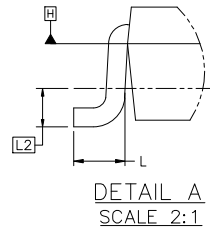
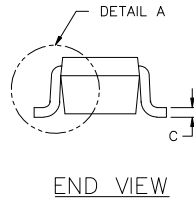
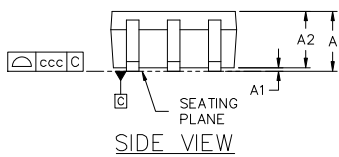
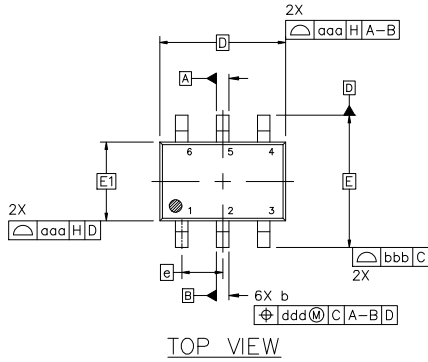

| DIM | MILLIMETERS | | |
|-----|-------------|------|------|
| | MIN. | NOM. | MAX. |
| A | --- | --- | 1.10 |
| A1 | 0.00 | --- | 0.10 |
| A2 | 0.70 | 0.90 | 1.00 |
| b | 0.15 | 0.20 | 0.25 |
| c | 0.08 | 0.15 | 0.22 |
| D | 2.00 BSC | | |
| E | 2.10 BSC | | |
| E1 | 1.25 BSC | | |
| e | 0.65 BSC | | |
| L | 0.26 | 0.36 | 0.46 |
| L2 | 0.15 BSC | | |
| aaa | 0.15 | | |
| bbb | 0.30 | | |
| ccc | 0.10 | | |
| ddd | 0.10 | | |

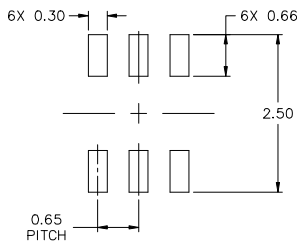

GENERIC MARKING DIAGRAM*

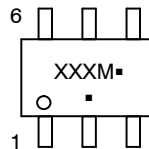

- XXX = Specific Device Code
- M = Date Code*
- = Pb-Free Package

(Note: Microdot may be in either location)
 *Date Code orientation and/or position may vary depending upon manufacturing location.
 *This information is generic. Please refer to device data sheet for actual part marking. Pb-Free indicator, "G" or microdot "▪", may or may not be present. Some products may not follow the Generic Marking.

FOR ADDITIONAL INFORMATION ON OUR Pb-FREE STRATEGY AND SOLDERING DETAILS, PLEASE DOWNLOAD THE ONSEMI SOLDERING AND MOUNTING TECHNIQUES REFERENCE MANUAL, SOLDERRM/D.

STYLES ON PAGE 2

| | | |
|-------------------------|------------------------------------|--|
| DOCUMENT NUMBER: | 98ASB42985B | Electronic versions are uncontrolled except when accessed directly from the Document Repository. Printed versions are uncontrolled except when stamped "CONTROLLED COPY" in red. |
| DESCRIPTION: | SC-88 2.00x1.25x0.90, 0.65P | PAGE 1 OF 2 |

onsemi and ONSEMI are trademarks of Semiconductor Components Industries, LLC dba onsemi or its subsidiaries in the United States and/or other countries. onsemi reserves the right to make changes without further notice to any products herein. onsemi makes no warranty, representation or guarantee regarding the suitability of its products for any particular purpose, nor does onsemi assume any liability arising out of the application or use of any product or circuit, and specifically disclaims any and all liability, including without limitation special, consequential or incidental damages. onsemi does not convey any license under its patent rights nor the rights of others.

SC-88 2.00x1.25x0.90, 0.65P
CASE 419B-02
ISSUE Z

DATE 18 APR 2024

| | | | | | |
|--|--|---|---|---|---|
| STYLE 1: PIN 1. EMITTER 2 2. BASE 2 3. COLLECTOR 1 4. EMITTER 1 5. BASE 1 6. COLLECTOR 2 | STYLE 2: CANCELLED | STYLE 3: CANCELLED | STYLE 4: PIN 1. CATHODE 2. CATHODE 3. COLLECTOR 4. EMITTER 5. BASE 6. ANODE | STYLE 5: PIN 1. ANODE 2. ANODE 3. COLLECTOR 4. EMITTER 5. BASE 6. CATHODE | STYLE 6: PIN 1. ANODE 2 2. N/C 3. CATHODE 1 4. ANODE 1 5. N/C 6. CATHODE 2 |
| STYLE 7: PIN 1. SOURCE 2 2. DRAIN 2 3. GATE 1 4. SOURCE 1 5. DRAIN 1 6. GATE 2 | STYLE 8: CANCELLED | STYLE 9: PIN 1. EMITTER 2 2. EMITTER 1 3. COLLECTOR 1 4. BASE 1 5. BASE 2 6. COLLECTOR 2 | STYLE 10: PIN 1. SOURCE 2 2. SOURCE 1 3. GATE 1 4. DRAIN 1 5. DRAIN 2 6. GATE 2 | STYLE 11: PIN 1. CATHODE 2 2. CATHODE 2 3. ANODE 1 4. CATHODE 1 5. CATHODE 1 6. ANODE 2 | STYLE 12: PIN 1. ANODE 2 2. ANODE 2 3. CATHODE 1 4. ANODE 1 5. ANODE 1 6. CATHODE 2 |
| STYLE 13: PIN 1. ANODE 2. N/C 3. COLLECTOR 4. EMITTER 5. BASE 6. CATHODE | STYLE 14: PIN 1. VREF 2. GND 3. GND 4. IOUT 5. VEN 6. VCC | STYLE 15: PIN 1. ANODE 1 2. ANODE 2 3. ANODE 3 4. CATHODE 3 5. CATHODE 2 6. CATHODE 1 | STYLE 16: PIN 1. BASE 1 2. EMITTER 2 3. COLLECTOR 2 4. BASE 2 5. EMITTER 1 6. COLLECTOR 1 | STYLE 17: PIN 1. BASE 1 2. EMITTER 1 3. COLLECTOR 2 4. BASE 2 5. EMITTER 2 6. COLLECTOR 1 | STYLE 18: PIN 1. VIN1 2. VCC 3. VOUT2 4. VIN2 5. GND 6. VOUT1 |
| STYLE 19: PIN 1. IOUT 2. GND 3. GND 4. V CC 5. V EN 6. V REF | STYLE 20: PIN 1. COLLECTOR 2. COLLECTOR 3. BASE 4. EMITTER 5. COLLECTOR 6. COLLECTOR | STYLE 21: PIN 1. ANODE 1 2. N/C 3. ANODE 2 4. CATHODE 2 5. N/C 6. CATHODE 1 | STYLE 22: PIN 1. D1 (i) 2. GND 3. D2 (i) 4. D2 (c) 5. VBUS 6. D1 (c) | STYLE 23: PIN 1. Vn 2. CH1 3. Vp 4. N/C 5. CH2 6. N/C | STYLE 24: PIN 1. CATHODE 2. ANODE 3. CATHODE 4. CATHODE 5. CATHODE 6. CATHODE |
| STYLE 25: PIN 1. BASE 1 2. CATHODE 3. COLLECTOR 2 4. BASE 2 5. EMITTER 6. COLLECTOR 1 | STYLE 26: PIN 1. SOURCE 1 2. GATE 1 3. DRAIN 2 4. SOURCE 2 5. GATE 2 6. DRAIN 1 | STYLE 27: PIN 1. BASE 2 2. BASE 1 3. COLLECTOR 1 4. EMITTER 1 5. EMITTER 2 6. COLLECTOR 2 | STYLE 28: PIN 1. DRAIN 2. DRAIN 3. GATE 4. SOURCE 5. DRAIN 6. DRAIN | STYLE 29: PIN 1. ANODE 2. ANODE 3. COLLECTOR 4. EMITTER 5. BASE/ANODE 6. CATHODE | STYLE 30: PIN 1. SOURCE 1 2. DRAIN 2 3. DRAIN 2 4. SOURCE 2 5. GATE 1 6. DRAIN 1 |

Note: Please refer to datasheet for style callout. If style type is not called out in the datasheet refer to the device datasheet pinout or pin assignment.

| | | |
|-------------------------|------------------------------------|---|
| DOCUMENT NUMBER: | 98ASB42985B | Electronic versions are uncontrolled except when accessed directly from the Document Repository. Printed versions are uncontrolled except when stamped "CONTROLLED COPY" in red. |
| DESCRIPTION: | SC-88 2.00x1.25x0.90, 0.65P | PAGE 2 OF 2 |

onsemi and **ONSEMI** are trademarks of Semiconductor Components Industries, LLC dba **onsemi** or its subsidiaries in the United States and/or other countries. **onsemi** reserves the right to make changes without further notice to any products herein. **onsemi** makes no warranty, representation or guarantee regarding the suitability of its products for any particular purpose, nor does **onsemi** assume any liability arising out of the application or use of any product or circuit, and specifically disclaims any and all liability, including without limitation special, consequential or incidental damages. **onsemi** does not convey any license under its patent rights nor the rights of others.

MECHANICAL CASE OUTLINE

PACKAGE DIMENSIONS

ON Semiconductor®



UQFN10 1.4x1.8, 0.4P

CASE 488AT-01
ISSUE A

DATE 01 AUG 2007

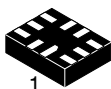

SCALE 5:1

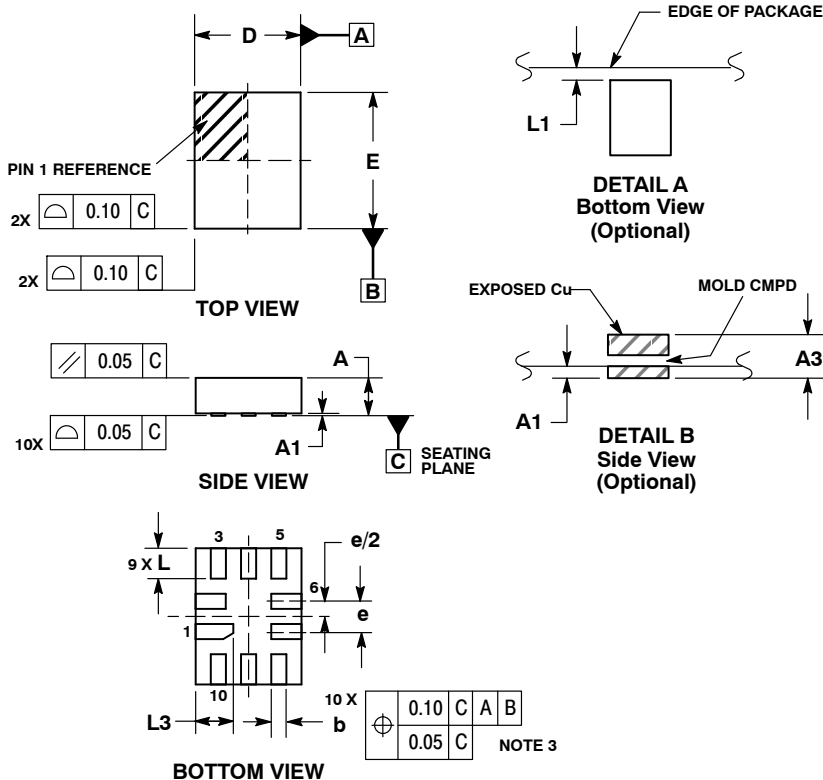

- NOTES:
- DIMENSIONING AND TOLERANCING PER ASME Y14.5M, 1994.
 - CONTROLLING DIMENSION: MILLIMETERS
 - DIMENSION b APPLIES TO PLATED TERMINAL AND IS MEASURED BETWEEN 0.25 AND 0.30 MM FROM TERMINAL.
 - COPLANARITY APPLIES TO THE EXPOSED PAD AS WELL AS THE TERMINALS.

| DIM | MILLIMETERS | |
|-----|-------------|------|
| | MIN | MAX |
| A | 0.45 | 0.60 |
| A1 | 0.00 | 0.05 |
| A3 | 0.127 REF | |
| b | 0.15 | 0.25 |
| D | 1.40 | BSC |
| E | 1.80 | BSC |
| e | 0.40 | BSC |
| L | 0.30 | 0.50 |
| L1 | 0.00 | 0.15 |
| L3 | 0.40 | 0.60 |

GENERIC MARKING DIAGRAM*

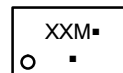

- XX = Specific Device Code
M = Date Code
▪ = Pb-Free Package
(Note: Microdot may be in either location)

*This information is generic. Please refer to device data sheet for actual part marking. Pb-Free indicator, "G" or microdot "▪", may or may not be present.

MOUNTING FOOTPRINT

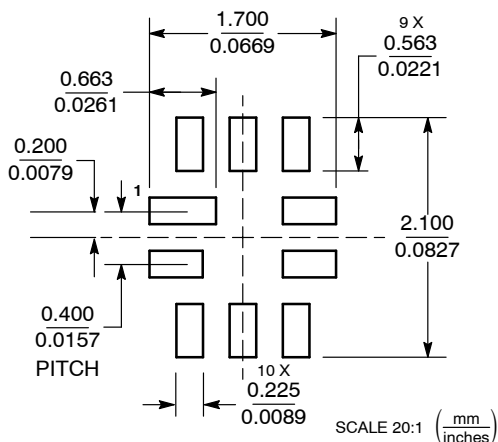

| | | |
|-------------------------|-------------------------------------|--|
| DOCUMENT NUMBER: | 98AON22493D | Electronic versions are uncontrolled except when accessed directly from the Document Repository. Printed versions are uncontrolled except when stamped "CONTROLLED COPY" in red. |
| DESCRIPTION: | 10 PIN UQFN, 1.4 X 1.8, 0.4P | PAGE 1 OF 1 |

ON Semiconductor and ON are trademarks of Semiconductor Components Industries, LLC dba ON Semiconductor or its subsidiaries in the United States and/or other countries. ON Semiconductor reserves the right to make changes without further notice to any products herein. ON Semiconductor makes no warranty, representation or guarantee regarding the suitability of its products for any particular purpose, nor does ON Semiconductor assume any liability arising out of the application or use of any product or circuit, and specifically disclaims any and all liability, including without limitation special, consequential or incidental damages. ON Semiconductor does not convey any license under its patent rights nor the rights of others.

onsemi, **Onsemi**, and other names, marks, and brands are registered and/or common law trademarks of Semiconductor Components Industries, LLC dba "**onsemi**" or its affiliates and/or subsidiaries in the United States and/or other countries. **onsemi** owns the rights to a number of patents, trademarks, copyrights, trade secrets, and other intellectual property. A listing of **onsemi**'s product/patent coverage may be accessed at www.onsemi.com/site/pdf/Patent-Marking.pdf. **onsemi** reserves the right to make changes at any time to any products or information herein, without notice. The information herein is provided "as-is" and **onsemi** makes no warranty, representation or guarantee regarding the accuracy of the information, product features, availability, functionality, or suitability of its products for any particular purpose, nor does **onsemi** assume any liability arising out of the application or use of any product or circuit, and specifically disclaims any and all liability, including without limitation special, consequential or incidental damages. Buyer is responsible for its products and applications using **onsemi** products, including compliance with all laws, regulations and safety requirements or standards, regardless of any support or applications information provided by **onsemi**. "Typical" parameters which may be provided in **onsemi** data sheets and/or specifications can and do vary in different applications and actual performance may vary over time. All operating parameters, including "Typicals" must be validated for each customer application by customer's technical experts. **onsemi** does not convey any license under any of its intellectual property rights nor the rights of others. **onsemi** products are not designed, intended, or authorized for use as a critical component in life support systems or any FDA Class 3 medical devices or medical devices with a same or similar classification in a foreign jurisdiction or any devices intended for implantation in the human body. Should Buyer purchase or use **onsemi** products for any such unintended or unauthorized application, Buyer shall indemnify and hold **onsemi** and its officers, employees, subsidiaries, affiliates, and distributors harmless against all claims, costs, damages, and expenses, and reasonable attorney fees arising out of, directly or indirectly, any claim of personal injury or death associated with such unintended or unauthorized use, even if such claim alleges that **onsemi** was negligent regarding the design or manufacture of the part. **onsemi** is an Equal Opportunity/Affirmative Action Employer. This literature is subject to all applicable copyright laws and is not for resale in any manner.

ADDITIONAL INFORMATION

TECHNICAL PUBLICATIONS:

Technical Library: www.onsemi.com/design/resources/technical-documentation
onsemi Website: www.onsemi.com

ONLINE SUPPORT: www.onsemi.com/support

For additional information, please contact your local Sales Representative at www.onsemi.com/support/sales

Looking for pricing, stock, or lifecycle information?

Click below to explore more details on WIN SOURCE:

 [View NCS211RSQT2G on WIN SOURCE](#)

 [ON Semiconductor](#) Information

Optimize Your Supply Chain with WIN SOURCE Solutions

-  Global Sourcing Solution
-  Obsolete Management
-  Cost Control Management
-  Shortage Management
-  Alternative Solution
-  Excess Inventory Management