



THE DATASHEET OF BVSS84LT1G



BSS84L, BVSS84L

Power MOSFET Single P-Channel SOT-23 -50 V, 10 Ω

- SOT-23 Surface Mount Package Saves Board Space
- BV Prefix for Automotive and Other Applications Requiring Unique Site and Control Change Requirements; AEC-Q101 Qualified and PPAP Capable
- These Devices are Pb-Free and are RoHS Compliant

MAXIMUM RATINGS (T_J = 25°C unless otherwise noted)

Rating	Symbol	Value	Unit
Drain-to-Source Voltage	V _{DSS}	50	Vdc
Gate-to-Source Voltage – Continuous	V _{GS}	± 20	Vdc
Drain Current Continuous @ T _A = 25°C Pulsed Drain Current (t _p ≤ 10 μs)	I _D I _{DM}	130 520	mA
Total Power Dissipation @ T _A = 25°C	P _D	225	mW
Operating and Storage Temperature Range	T _J , T _{stg}	- 55 to 150	°C
Thermal Resistance – Junction-to-Ambient	R _{θJA}	556	°C/W
Maximum Lead Temperature for Soldering Purposes, for 10 seconds	T _L	260	°C

Stresses exceeding those listed in the Maximum Ratings table may damage the device. If any of these limits are exceeded, device functionality should not be assumed, damage may occur and reliability may be affected.



ON Semiconductor®

www.onsemi.com

V _{(BR)DSS}	R _{DS(ON)} MAX
-50 V	10 Ω @ 10 V

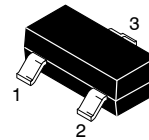
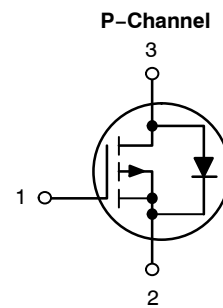

SOT-23
CASE 318
STYLE 21

MARKING DIAGRAM & PIN ASSIGNMENT

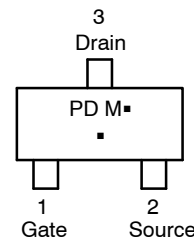

PD = Specific Device Code
M = Date Code
▪ = Pb-Free Package

(*Note: Microdot may be in either location)

ORDERING INFORMATION

Device	Package	Shipping†
BSS84LT1G, BVSS84LT1G	SOT-23 (Pb-Free)	3,000 / Tape & Reel
BSS84LT7G	SOT-23 (Pb-Free)	3,500 / Tape & Reel

†For information on tape and reel specifications, including part orientation and tape sizes, please refer to our Tape and Reel Packaging Specifications Brochure, BRD8011/D.

BSS84L, BVSS84L

ELECTRICAL CHARACTERISTICS ($T_A = 25^\circ\text{C}$ unless otherwise noted)

Characteristic	Symbol	Min	Typ	Max	Unit
OFF CHARACTERISTICS					
Drain-to-Source Breakdown Voltage ($V_{GS} = 0\text{ Vdc}$, $I_D = -250\ \mu\text{Adc}$)	$V_{(BR)DSS}$	-50	-	-	Vdc
Zero Gate Voltage Drain Current ($V_{DS} = -25\text{ Vdc}$, $V_{GS} = 0\text{ Vdc}$) ($V_{DS} = -50\text{ Vdc}$, $V_{GS} = 0\text{ Vdc}$) ($V_{DS} = -50\text{ Vdc}$, $V_{GS} = 0\text{ Vdc}$, $T_J = 125^\circ\text{C}$)	I_{DSS}	-	-	-0.1 -15 -60	μAdc
Gate-Body Leakage Current ($V_{GS} = \pm 20\text{ Vdc}$, $V_{DS} = 0\text{ Vdc}$)	I_{GSS}	-	-	± 10	nAdc

ON CHARACTERISTICS (Note 1)

Gate-Source Threshold Voltage ($V_{DS} = V_{GS}$, $I_D = -250\ \mu\text{A}$)	$V_{GS(th)}$	-0.9	-	-2.0	Vdc
Static Drain-to-Source On-Resistance ($V_{GS} = -5.0\text{ Vdc}$, $I_D = -100\ \text{mAdc}$)	$R_{DS(on)}$	-	4.7	10	Ω
Transfer Admittance ($V_{DS} = -25\text{ Vdc}$, $I_D = -100\ \text{mAdc}$, $f = 1.0\text{ kHz}$)	$ Y_{fs} $	50	-	-	mS

DYNAMIC CHARACTERISTICS

Input Capacitance	$V_{DS} = 5.0\text{ Vdc}$	C_{iss}	-	36	-	pF
Output Capacitance	$V_{DS} = 5.0\text{ Vdc}$	C_{oss}	-	17	-	
Transfer Capacitance	$V_{DG} = 5.0\text{ Vdc}$	C_{rss}	-	6.5	-	

SWITCHING CHARACTERISTICS (Note 2)

Turn-On Delay Time	$V_{DD} = -15\text{ Vdc}$, $I_D = -2.5\text{ Adc}$, $R_L = 50\ \Omega$	$t_{d(on)}$	-	3.6	-	ns
Rise Time		t_r	-	9.7	-	
Turn-Off Delay Time		$t_{d(off)}$	-	12	-	
Fall Time		t_f	-	1.7	-	
Gate Charge	$V_{DD} = -40\text{ Vdc}$, $I_D = -0.5\text{ A}$, $V_{GS} = -10\text{ V}$	Q_T	-	2.2	-	nC

SOURCE-DRAIN DIODE CHARACTERISTICS

Continuous Current		I_S	-	-	-0.130	A
Pulsed Current		I_{SM}	-	-	-0.520	
Forward Voltage (Note 2)	$V_{GS} = 0\text{ V}$, $I_S = -130\text{ mA}$	V_{SD}	-	-	-2.2	V

Product parametric performance is indicated in the Electrical Characteristics for the listed test conditions, unless otherwise noted. Product performance may not be indicated by the Electrical Characteristics if operated under different conditions.

1. Pulse Test: Pulse Width $\leq 300\ \mu\text{s}$, Duty Cycle $\leq 2\%$.
2. Switching characteristics are independent of operating junction temperature.

TYPICAL ELECTRICAL CHARACTERISTICS

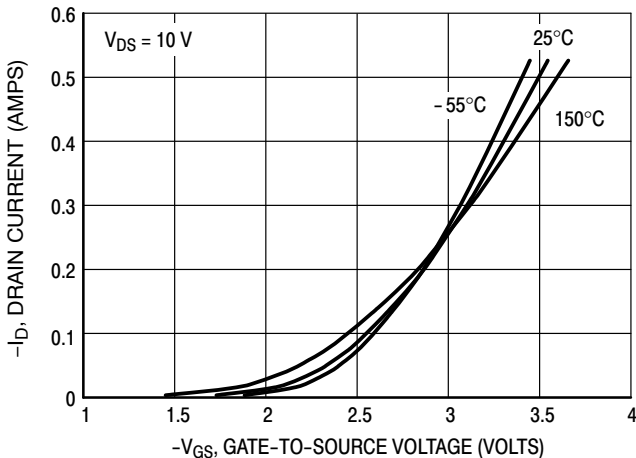

Figure 1. Transfer Characteristics

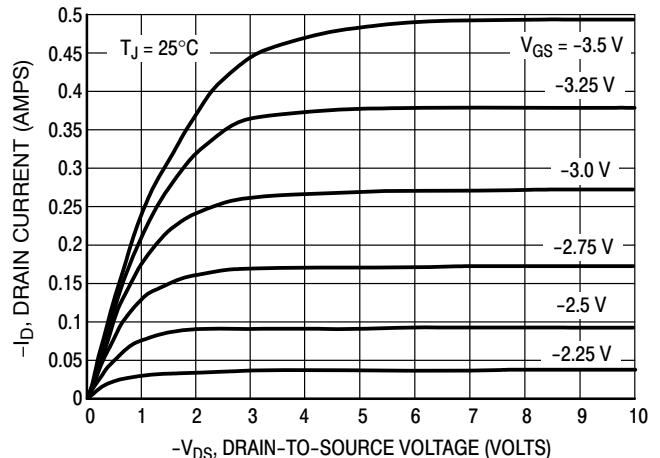

Figure 2. On-Region Characteristics

BSS84L, BVSS84L

TYPICAL ELECTRICAL CHARACTERISTICS

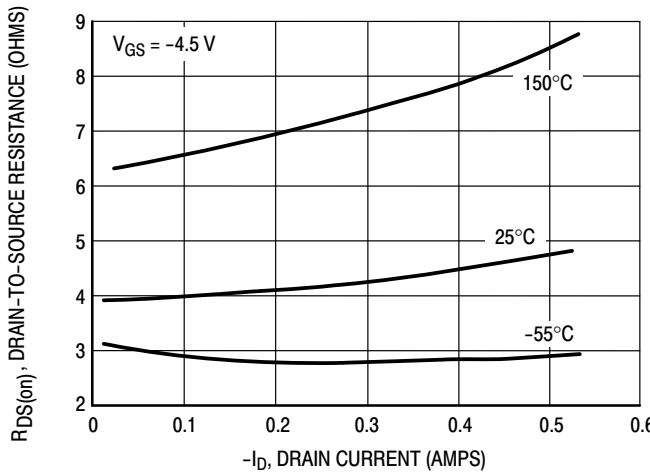

Figure 3. On-Resistance versus Drain Current

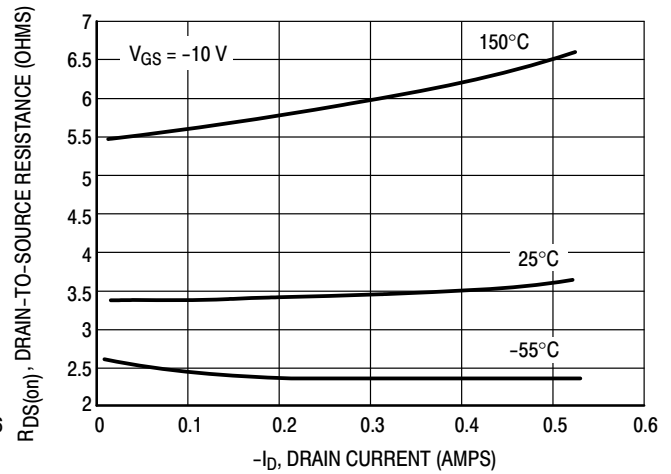

Figure 4. On-Resistance versus Drain Current

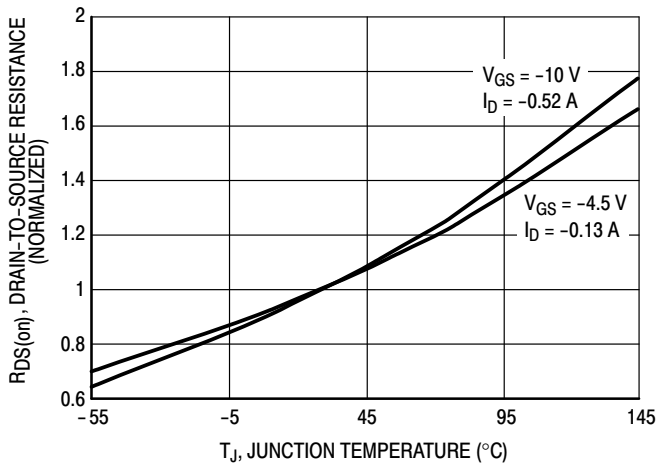

Figure 5. On-Resistance Variation with Temperature

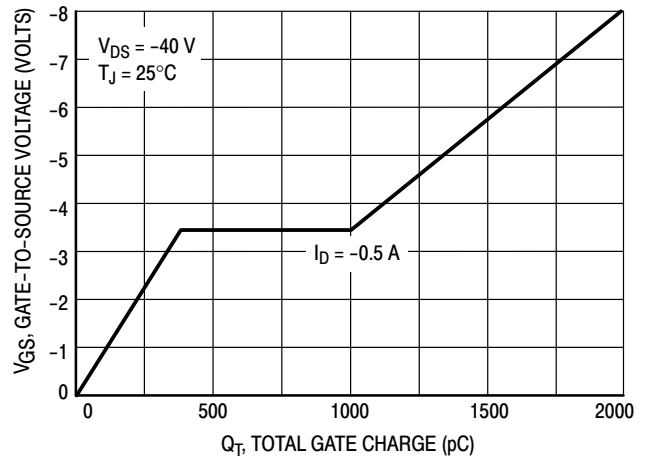

Figure 6. Gate Charge

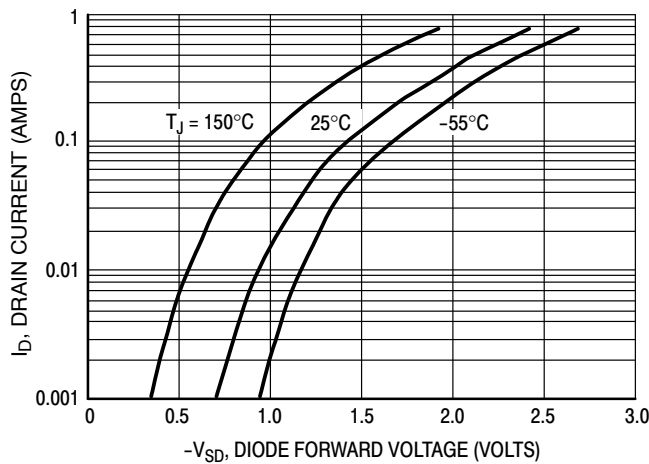
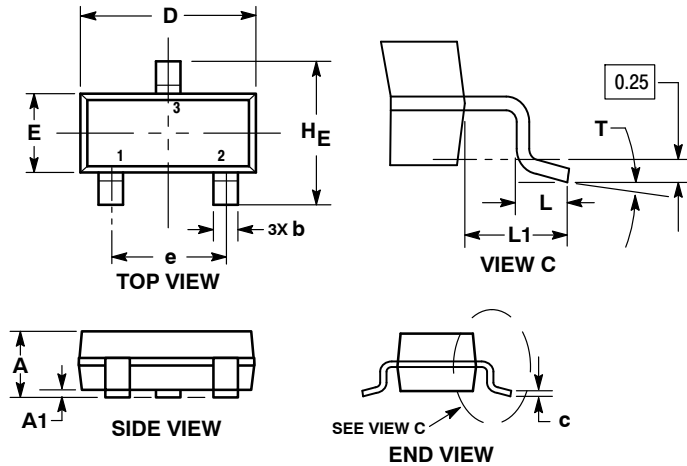

Figure 7. Body Diode Forward Voltage

BSS84L, BVSS84L

PACKAGE DIMENSIONS

SOT-23 (TO-236)
CASE 318-08
ISSUE AS



NOTES:

1. DIMENSIONING AND TOLERANCING PER ASME Y14.5M, 1994.
2. CONTROLLING DIMENSION: MILLIMETERS.
3. MAXIMUM LEAD THICKNESS INCLUDES LEAD FINISH. MINIMUM LEAD THICKNESS IS THE MINIMUM THICKNESS OF THE BASE MATERIAL.
4. DIMENSIONS D AND E DO NOT INCLUDE MOLD FLASH, PROTRUSIONS, OR GATE BURRS.

DIM	MILLIMETERS			INCHES		
	MIN	NOM	MAX	MIN	NOM	MAX
A	0.89	1.00	1.11	0.035	0.039	0.044
A1	0.01	0.06	0.10	0.000	0.002	0.004
b	0.37	0.44	0.50	0.015	0.017	0.020
c	0.08	0.14	0.20	0.003	0.006	0.008
D	2.80	2.90	3.04	0.110	0.114	0.120
E	1.20	1.30	1.40	0.047	0.051	0.055
e	1.78	1.90	2.04	0.070	0.075	0.080
L	0.30	0.43	0.55	0.012	0.017	0.022
L1	0.35	0.54	0.69	0.014	0.021	0.027
HE	2.10	2.40	2.64	0.083	0.094	0.104
T	0°	---	10°	0°	---	10°

STYLE 21:

1. GATE
2. SOURCE
3. DRAIN

RECOMMENDED SOLDERING FOOTPRINT*

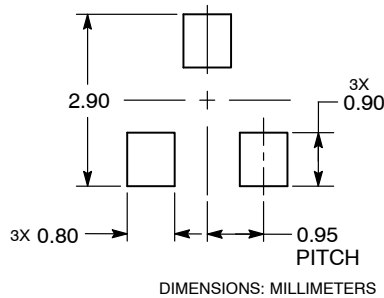

*For additional information on our Pb-Free strategy and soldering details, please download the ON Semiconductor Soldering and Mounting Techniques Reference Manual, SOLDERRM/D.

ON Semiconductor and are trademarks of Semiconductor Components Industries, LLC dba ON Semiconductor or its subsidiaries in the United States and/or other countries. ON Semiconductor owns the rights to a number of patents, trademarks, copyrights, trade secrets, and other intellectual property. A listing of ON Semiconductor's product/patent coverage may be accessed at www.onsemi.com/site/pdf/Patent-Marking.pdf. ON Semiconductor reserves the right to make changes without further notice to any products herein. ON Semiconductor makes no warranty, representation or guarantee regarding the suitability of its products for any particular purpose, nor does ON Semiconductor assume any liability arising out of the application or use of any product or circuit, and specifically disclaims any and all liability, including without limitation special, consequential or incidental damages. Buyer is responsible for its products and applications using ON Semiconductor products, including compliance with all laws, regulations and safety requirements or standards, regardless of any support or applications information provided by ON Semiconductor. "Typical" parameters which may be provided in ON Semiconductor data sheets and/or specifications can and do vary in different applications and actual performance may vary over time. All operating parameters, including "Typicals" must be validated for each customer application by customer's technical experts. ON Semiconductor does not convey any license under its patent rights nor the rights of others. ON Semiconductor products are not designed, intended, or authorized for use as a critical component in life support systems or any FDA Class 3 medical devices or medical devices with a same or similar classification in a foreign jurisdiction or any devices intended for implantation in the human body. Should Buyer purchase or use ON Semiconductor products for any such unintended or unauthorized application, Buyer shall indemnify and hold ON Semiconductor and its officers, employees, subsidiaries, affiliates, and distributors harmless against all claims, costs, damages, and expenses, and reasonable attorney fees arising out of, directly or indirectly, any claim of personal injury or death associated with such unintended or unauthorized use, even if such claim alleges that ON Semiconductor was negligent regarding the design or manufacture of the part. ON Semiconductor is an Equal Opportunity/Affirmative Action Employer. This literature is subject to all applicable copyright laws and is not for resale in any manner.

PUBLICATION ORDERING INFORMATION

LITERATURE FULFILLMENT:
Literature Distribution Center for ON Semiconductor
19521 E. 32nd Pkwy, Aurora, Colorado 80011 USA
Phone: 303-675-2175 or 800-344-3860 Toll Free USA/Canada
Fax: 303-675-2176 or 800-344-3867 Toll Free USA/Canada
Email: orderlit@onsemi.com

N. American Technical Support: 800-282-9855 Toll Free
USA/Canada
Europe, Middle East and Africa Technical Support:
Phone: 421 33 790 2910

ON Semiconductor Website: www.onsemi.com
Order Literature: <http://www.onsemi.com/orderlit>

For additional information, please contact your local Sales Representative

Looking for pricing, stock, or lifecycle information?

Click below to explore more details on WIN SOURCE:

 [View BVSS84LT1G on WIN SOURCE](#)

 [ON Semiconductor](#) Information

Optimize Your Supply Chain with WIN SOURCE Solutions

-  Global Sourcing Solution
-  Obsolete Management
-  Cost Control Management
-  Shortage Management
-  Alternative Solution
-  Excess Inventory Management