

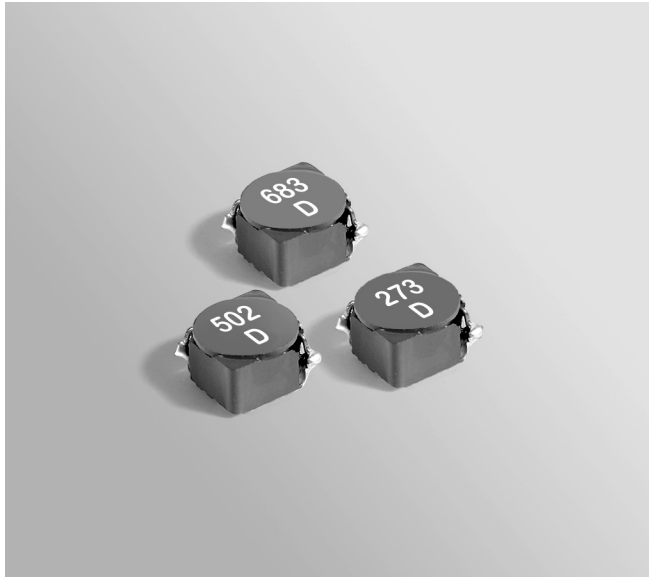

**THE DATASHEET OF  
MSS7341-224MLD**



# Shielded Power Inductors – MSS7341



- 6.6 × 6.6 mm footprint; 4.1 mm high shielded inductors
- Low DCR and excellent current handling

**Designer's Kit C385** contains 3 each of all values.

**Core material** Ferrite

**Core and winding loss** See [www.coilcraft.com/coreloss](http://www.coilcraft.com/coreloss)

**Terminations** RoHS compliant matte tin over nickel over phos bronze (current production) or gold over nickel over phos bronze (prior production). Other terminations available at additional cost.

**Weight:** 0.61 – 0.67 g

**Ambient temperature** –40°C to +85°C with (40°C rise) Irms current.

**Maximum part temperature** +125°C (ambient + temp rise). [Derating](#).

**Storage temperature** Component: –40°C to +125°C.

Tape and reel packaging: –40°C to +80°C

**Resistance to soldering heat** Max three 40 second reflows at +260°C, parts cooled to room temperature between cycles

**Moisture Sensitivity Level (MSL)** 1 (unlimited floor life at <30°C / 85% relative humidity)

**Packaging** 300/7 reel; 1200/13" reel; Plastic tape: 16 mm wide, 0.35 mm thick, 12 mm pocket spacing, 4.5 mm pocket depth

**PCB washing** Tested to MIL-STD-202 Method 215 plus an additional aqueous wash. See [Doc787\\_PCB\\_Washing.pdf](#).

## Typical Temperature Rise vs Current

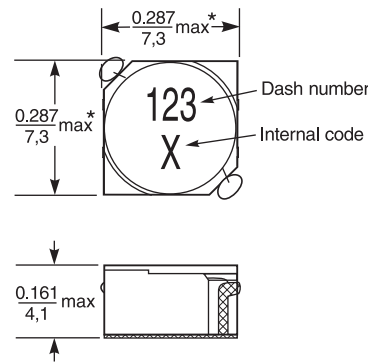
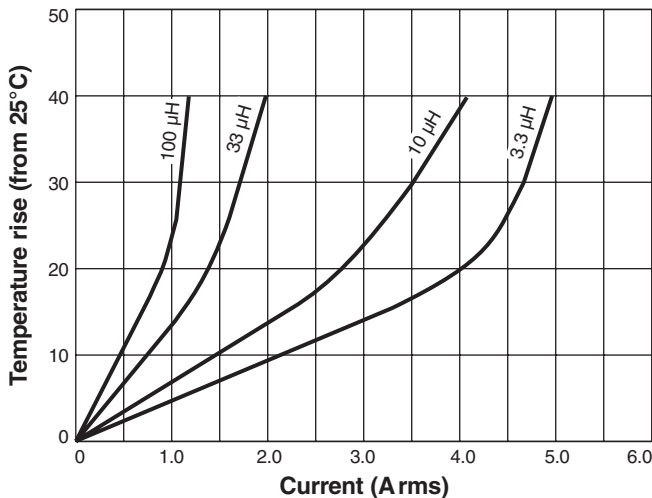

Parts manufactured prior to Sept. 2007 were marked with only the dash number.

\*Dimensions are of the case not including the termination. For maximum overall dimensions including the termination, add 0.02 in / 0,51 mm.

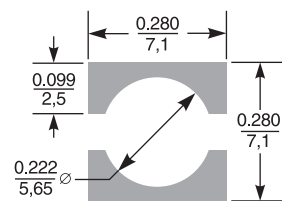
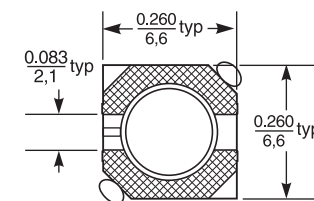

Dimensions are in  $\frac{\text{inches}}{\text{mm}}$

**Recommended Land Pattern**



# Shielded Power Inductors – MSS7341

Part number <sup>1</sup>	Inductance <sup>2</sup> ( $\mu$ H)	Percent tolerance <sup>3</sup>	DCR (Ohms)		SRF typ <sup>4</sup> (MHz)	Isat (A) <sup>5</sup>			Irms (A) <sup>6</sup>	
			typ	max		10% drop	20% drop	30% drop	20°C rise	40°C rise
MSS7341-332_L_	3.3	<b>30,20</b>	0.014	0.018	85	2.74	3.28	3.72	3.95	5.00
MSS7341-502_L_	5.0	<b>30,20</b>	0.018	0.023	49	2.30	2.82	3.16	3.40	4.70
MSS7341-622_L_	6.2	<b>30,20</b>	0.024	0.027	42	2.18	2.66	2.98	3.05	4.30
MSS7341-742_L_	7.4	<b>30,20</b>	0.027	0.031	35	1.92	2.32	2.56	2.80	4.10
MSS7341-872_L_	8.7	<b>30,20</b>	0.029	0.034	33	1.78	2.12	2.36	2.80	3.90
MSS7341-103ML_	10	<b>20</b>	0.032	0.038	32	1.64	1.92	2.10	2.80	3.80
MSS7341-123ML_	12	<b>20</b>	0.040	0.050	27	1.48	1.76	1.92	2.45	3.30
MSS7341-153ML_	15	<b>20</b>	0.047	0.055	26	1.36	1.60	1.78	2.05	3.00
MSS7341-183ML_	18	<b>20</b>	0.065	0.075	25	1.20	1.46	1.62	1.85	2.65
MSS7341-223ML_	22	<b>20</b>	0.074	0.082	22	1.02	1.26	1.42	1.70	2.35
MSS7341-273ML_	27	<b>20</b>	0.091	0.109	19	1.00	1.14	1.22	1.50	2.10
MSS7341-333ML_	33	<b>20</b>	0.104	0.124	17	0.91	1.04	1.16	1.50	1.95
MSS7341-393ML_	39	<b>20</b>	0.115	0.130	15	0.85	1.01	1.12	1.50	1.90
MSS7341-473ML_	47	<b>20</b>	0.127	0.155	14	0.74	0.92	1.00	1.50	1.85
MSS7341-563ML_	56	<b>20</b>	0.174	0.202	11	0.68	0.80	0.87	1.25	1.60
MSS7341-683ML_	68	<b>20</b>	0.236	0.250	9.6	0.62	0.73	0.80	1.00	1.35
MSS7341-823ML_	82	<b>20</b>	0.257	0.290	8.5	0.57	0.66	0.72	1.00	1.25
MSS7341-104ML_	100	<b>20</b>	0.286	0.310	7.2	0.54	0.64	0.71	0.90	1.15
MSS7341-154ML_	150	<b>20</b>	0.438	0.475	6.0	0.45	0.53	0.58	0.86	1.14
MSS7341-224ML_	220	<b>20</b>	0.660	0.710	5.0	0.35	0.41	0.47	0.57	0.78
MSS7341-474ML_	470	<b>20</b>	1.21	1.45	3.0	0.24	0.28	0.32	0.43	0.57
MSS7341-684KL_	680	<b>10</b>	1.85	1.98	2.5	0.22	0.27	0.29	0.42	0.56

1. When ordering, specify **tolerance, termination and packaging** codes:

**MSS7341-684KLD**

**Tolerance:** M= 20%, N = 30% (Table shows stock tolerances in bold.)

**Termination:** L = RoHS compliant matte tin over nickel over phos bronze  
**Special order:** T = RoHS tin-silver-copper (95.5/4/0.5) over gold over nickel over phos bronze or S = non-RoHS tin-lead (63/37) over gold over nickel over phos bronze.

**Packaging:** C = 7" machine-ready reel. EIA-481 embossed plastic tape. Special order (300 parts per full reel). Quantities less than full reel available: in tape (not machine ready) or with leader and trailer (\$25 charge).

D = 13" machine-ready reel. EIA-481 embossed plastic tape (1200 parts per full reel).

B = Less than full reel. In an effort to simplify our part numbering system, Coilcraft is eliminating the need for multiple packaging codes. When ordering, simply change the last letter of your part number from B to C.

2. Inductance measured at 100 kHz, 0.1 Vrms, 0 Adc using a Coilcraft SMD-A fixture in an Agilent/HP 4263B LCR meter.

3. Tolerances in bold are stocked for immediate shipment.

4. SRF measured using an Agilent/HP 8753D network analyzer and a Coilcraft SMD-D test fixture.

5. DC current at 25°C that causes the specified inductance drop from its value without current. [Click for temperature derating information.](#)

6. Current that causes the specified temperature rise from 25°C ambient. This information is for reference only and does not represent absolute maximum ratings. [Click for temperature derating information.](#)

7. Electrical specifications at 25°C.

Refer to Doc 362 "Soldering Surface Mount Components" before soldering.

## Typical L vs Current

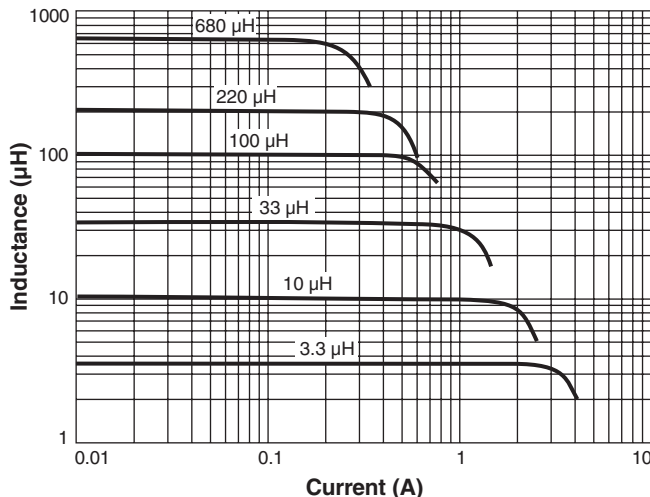

## Typical L vs Frequency

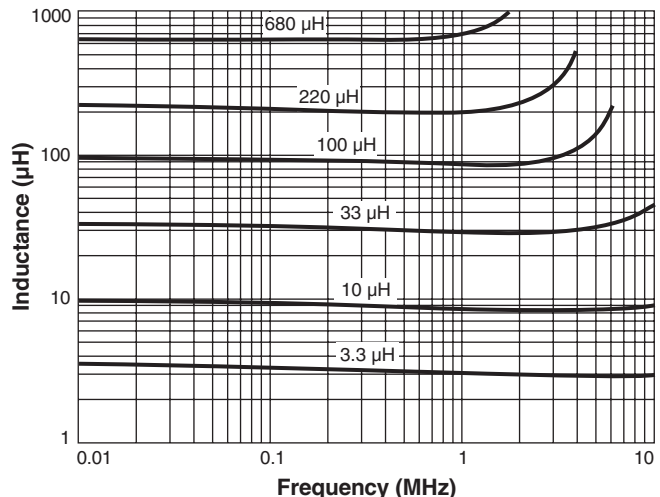

**US** +1-847-639-6400 sales@coilcraft.com  
**UK** +44-1236-730595 sales@coilcraft-europe.com  
**Taiwan** +886-2-2264 3646 sales@coilcraft.com.tw  
**China** +86-21-6218 8074 sales@coilcraft.com.cn  
**Singapore** + 65-6484 8412 sales@coilcraft.com.sg

Document 383-2 Revised 11/18/21

© Coilcraft Inc. 2021

This product may not be used in medical or high risk applications without prior Coilcraft approval. Specification subject to change without notice. Please check web site for latest information.

## Looking for pricing, stock, or lifecycle information?

Click below to explore more details on WIN SOURCE:

 [View MSS7341-224MLD on WIN SOURCE](#)

 [Coilcraft Information](#)

## Optimize Your Supply Chain with WIN SOURCE Solutions

-  Global Sourcing Solution
-  Obsolete Management
-  Cost Control Management
-  Shortage Management
-  Alternative Solution
-  Excess Inventory Management