



**THE DATASHEET OF
IPA040N06NXKSA1**



MOSFET

Metal Oxide Semiconductor Field Effect Transistor

OptiMOS™

OptiMOS™ Power-Transistor, 60 V
IPA040N06N

Data Sheet

Rev. 2.1
Final

1 Description

Features

- Optimized for high performance SMPS, e.g. sync. rec.
- 100% avalanche tested
- Superior thermal resistance
- N-channel
- Qualified according to JEDEC¹⁾ for target applications
- Pb-free lead plating; RoHS compliant
- Halogen-free according to IEC61249-2-21



Table 1 Key Performance Parameters

| Parameter | Value | Unit |
|------------------|-------|------|
| V_{DS} | 60 | V |
| $R_{DS(on),max}$ | 4.0 | mΩ |
| I_D | 69 | A |
| Q_{OSS} | 44 | nC |
| $Q_G(0V..10V)$ | 38 | nC |

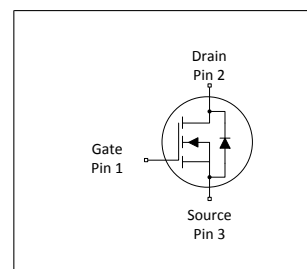

| Type / Ordering Code | Package | Marking | Related Links |
|----------------------|-------------|---------|---------------|
| IPA040N06N | PG-TO220-FP | 040N06N | - |

¹⁾ J-STD20 and JESD22

Table of Contents

| | |
|---|----|
| Description | 2 |
| Maximum ratings | 4 |
| Thermal characteristics | 4 |
| Electrical characteristics | 4 |
| Electrical characteristics diagrams | 6 |
| Package Outlines | 10 |
| Revision History | 11 |
| Disclaimer | 11 |

2 Maximum ratings

at $T_j = 25\text{ °C}$, unless otherwise specified

Table 2 Maximum ratings

| Parameter | Symbol | Values | | | Unit | Note / Test Condition |
|--|----------------|--------|------|----------|------|---|
| | | Min. | Typ. | Max. | | |
| Continuous drain current | I_D | - | - | 69 48 | A | $V_{GS}=10\text{ V}$, $T_C=25\text{ °C}$ $V_{GS}=10\text{ V}$, $T_C=100\text{ °C}$ |
| Pulsed drain current ¹⁾ | $I_{D,pulse}$ | - | - | 276 | A | $T_C=25\text{ °C}$ |
| Avalanche energy, single pulse ²⁾ | E_{AS} | - | - | 77 | mJ | $I_D=69\text{ A}$, $R_{GS}=25\text{ }\Omega$ |
| Gate source voltage | V_{GS} | -20 | - | 20 | V | - |
| Power dissipation | P_{tot} | - | - | 36 | W | $T_C=25\text{ °C}$ |
| Operating and storage temperature | T_j, T_{stg} | -55 | - | 175 | °C | IEC climatic category; DIN IEC 68-1: 55/175/56 |

3 Thermal characteristics

Table 3 Thermal characteristics

| Parameter | Symbol | Values | | | Unit | Note / Test Condition |
|-------------------------------------|------------|--------|------|------|------|-----------------------|
| | | Min. | Typ. | Max. | | |
| Thermal resistance, junction - case | R_{thJC} | - | 3.1 | 4.2 | K/W | - |

4 Electrical characteristics

Table 4 Static characteristics

| Parameter | Symbol | Values | | | Unit | Note / Test Condition |
|----------------------------------|---------------|--------|------------|------------|---------------|---|
| | | Min. | Typ. | Max. | | |
| Drain-source breakdown voltage | $V_{(BR)DSS}$ | 60 | - | - | V | $V_{GS}=0\text{ V}$, $I_D=1\text{ mA}$ |
| Gate threshold voltage | $V_{GS(th)}$ | 2.1 | 2.8 | 3.3 | V | $V_{DS}=V_{GS}$, $I_D=50\text{ }\mu\text{A}$ |
| Zero gate voltage drain current | I_{DSS} | - | 0.1 10 | 1 100 | μA | $V_{DS}=60\text{ V}$, $V_{GS}=0\text{ V}$, $T_j=25\text{ °C}$ $V_{DS}=60\text{ V}$, $V_{GS}=0\text{ V}$, $T_j=125\text{ °C}$ |
| Gate-source leakage current | I_{GSS} | - | 10 | 100 | nA | $V_{GS}=20\text{ V}$, $V_{DS}=0\text{ V}$ |
| Drain-source on-state resistance | $R_{DS(on)}$ | - | 3.6 4.7 | 4.0 5.0 | m Ω | $V_{GS}=10\text{ V}$, $I_D=69\text{ A}$ $V_{GS}=6\text{ V}$, $I_D=18\text{ A}$ |
| Gate resistance ³⁾ | R_G | - | 1.3 | 1.95 | Ω | - |
| Transconductance | g_{fs} | 55 | 110 | - | S | $ V_{DS} >2 I_D /R_{DS(on)max}$, $I_D=69\text{ A}$ |

¹⁾ See figure 3 for more detailed information

²⁾ See figure 13 for more detailed information

³⁾ Defined by design. Not subject to production test

Table 5 Dynamic characteristics¹⁾

| Parameter | Symbol | Values | | | Unit | Note / Test Condition |
|------------------------------|--------------|--------|------|------|------|---|
| | | Min. | Typ. | Max. | | |
| Input capacitance | C_{iss} | - | 2700 | 3375 | pF | $V_{GS}=0\text{ V}$, $V_{DS}=30\text{ V}$, $f=1\text{ MHz}$ |
| Output capacitance | C_{oss} | - | 670 | 838 | pF | $V_{GS}=0\text{ V}$, $V_{DS}=30\text{ V}$, $f=1\text{ MHz}$ |
| Reverse transfer capacitance | C_{rss} | - | 28 | 56 | pF | $V_{GS}=0\text{ V}$, $V_{DS}=30\text{ V}$, $f=1\text{ MHz}$ |
| Turn-on delay time | $t_{d(on)}$ | - | 14 | - | ns | $V_{DD}=30\text{ V}$, $V_{GS}=10\text{ V}$, $I_D=69\text{ A}$, $R_{G,ext}=3\ \Omega$ |
| Rise time | t_r | - | 16 | - | ns | $V_{DD}=30\text{ V}$, $V_{GS}=10\text{ V}$, $I_D=69\text{ A}$, $R_{G,ext}=3\ \Omega$ |
| Turn-off delay time | $t_{d(off)}$ | - | 33 | - | ns | $V_{DD}=30\text{ V}$, $V_{GS}=10\text{ V}$, $I_D=69\text{ A}$, $R_{G,ext}=3\ \Omega$ |
| Fall time | t_f | - | 8 | - | ns | $V_{DD}=30\text{ V}$, $V_{GS}=10\text{ V}$, $I_D=69\text{ A}$, $R_{G,ext}=3\ \Omega$ |

Table 6 Gate charge characteristics²⁾

| Parameter | Symbol | Values | | | Unit | Note / Test Condition |
|------------------------------------|---------------|--------|------|------|------|---|
| | | Min. | Typ. | Max. | | |
| Gate to source charge | Q_{gs} | - | 13 | - | nC | $V_{DD}=30\text{ V}$, $I_D=69\text{ A}$, $V_{GS}=0\text{ to }10\text{ V}$ |
| Gate charge at threshold | $Q_{g(th)}$ | - | 8 | - | nC | $V_{DD}=30\text{ V}$, $I_D=69\text{ A}$, $V_{GS}=0\text{ to }10\text{ V}$ |
| Gate to drain charge ¹⁾ | Q_{gd} | - | 7 | 9 | nC | $V_{DD}=30\text{ V}$, $I_D=69\text{ A}$, $V_{GS}=0\text{ to }10\text{ V}$ |
| Switching charge | Q_{sw} | - | 13 | - | nC | $V_{DD}=30\text{ V}$, $I_D=69\text{ A}$, $V_{GS}=0\text{ to }10\text{ V}$ |
| Gate charge total | Q_g | - | 38 | 44 | nC | $V_{DD}=30\text{ V}$, $I_D=69\text{ A}$, $V_{GS}=0\text{ to }10\text{ V}$ |
| Gate plateau voltage | $V_{plateau}$ | - | 4.8 | - | V | $V_{DD}=30\text{ V}$, $I_D=69\text{ A}$, $V_{GS}=0\text{ to }10\text{ V}$ |
| Gate charge total, sync. FET | $Q_{g(sync)}$ | - | 33 | - | nC | $V_{DS}=0.1\text{ V}$, $V_{GS}=0\text{ to }10\text{ V}$ |
| Output charge ¹⁾ | Q_{oss} | - | 44 | 55 | nC | $V_{DD}=30\text{ V}$, $V_{GS}=0\text{ V}$ |

Table 7 Reverse diode

| Parameter | Symbol | Values | | | Unit | Note / Test Condition |
|---------------------------------------|---------------|--------|------|------|------|--|
| | | Min. | Typ. | Max. | | |
| Diode continuous forward current | I_S | - | - | 30 | A | $T_C=25\text{ }^\circ\text{C}$ |
| Diode pulse current | $I_{S,pulse}$ | - | - | 276 | A | $T_C=25\text{ }^\circ\text{C}$ |
| Diode forward voltage | V_{SD} | - | 0.88 | 1.2 | V | $V_{GS}=0\text{ V}$, $I_F=30\text{ A}$, $T_J=25\text{ }^\circ\text{C}$ |
| Reverse recovery time ¹⁾ | t_{rr} | - | 33 | 53 | ns | $V_R=30\text{ V}$, $I_F=30\text{ A}$, $di_F/dt=100\text{ A}/\mu\text{s}$ |
| Reverse recovery charge ¹⁾ | Q_{rr} | - | 28 | - | nC | $V_R=30\text{ V}$, $I_F=30\text{ A}$, $di_F/dt=100\text{ A}/\mu\text{s}$ |

¹⁾ Defined by design. Not subject to production test

²⁾ See "Gate charge waveforms" for parameter definition

5 Electrical characteristics diagrams

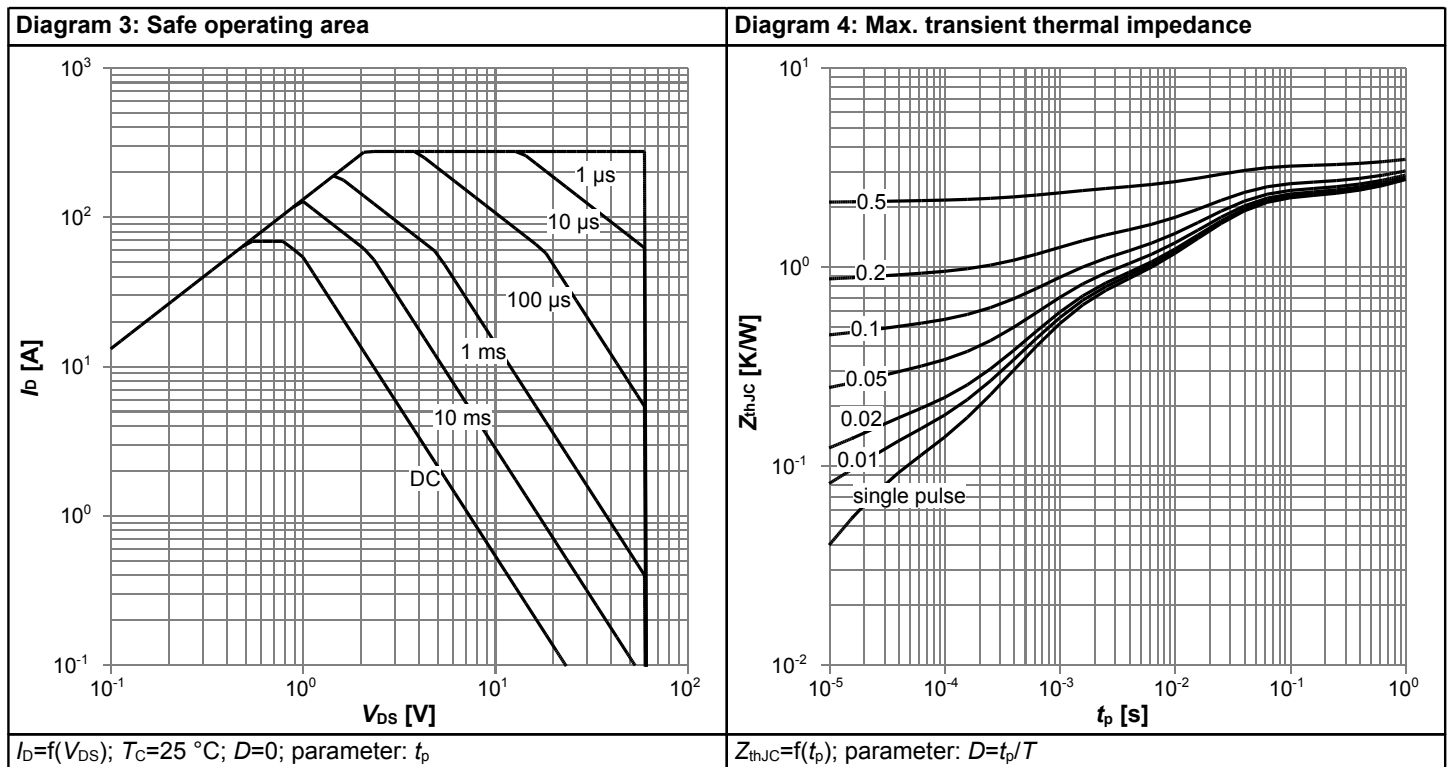
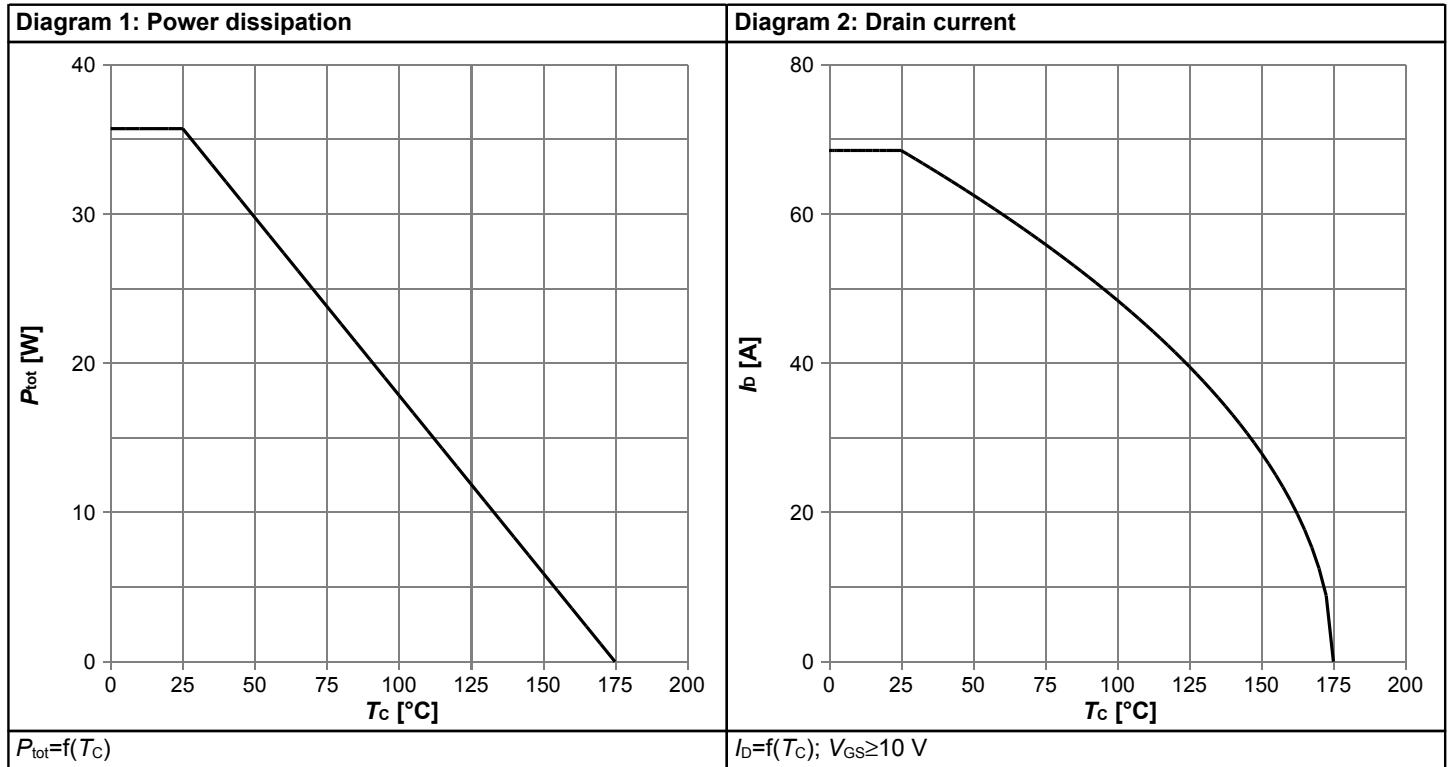
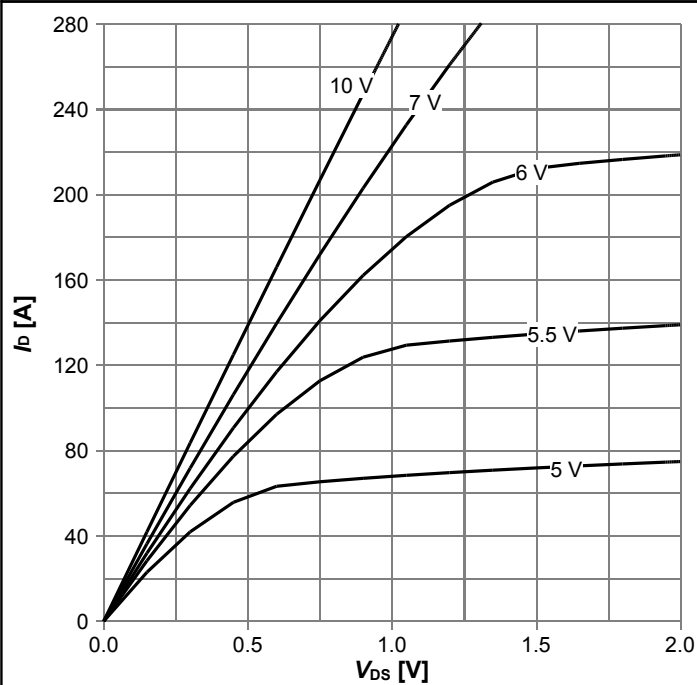
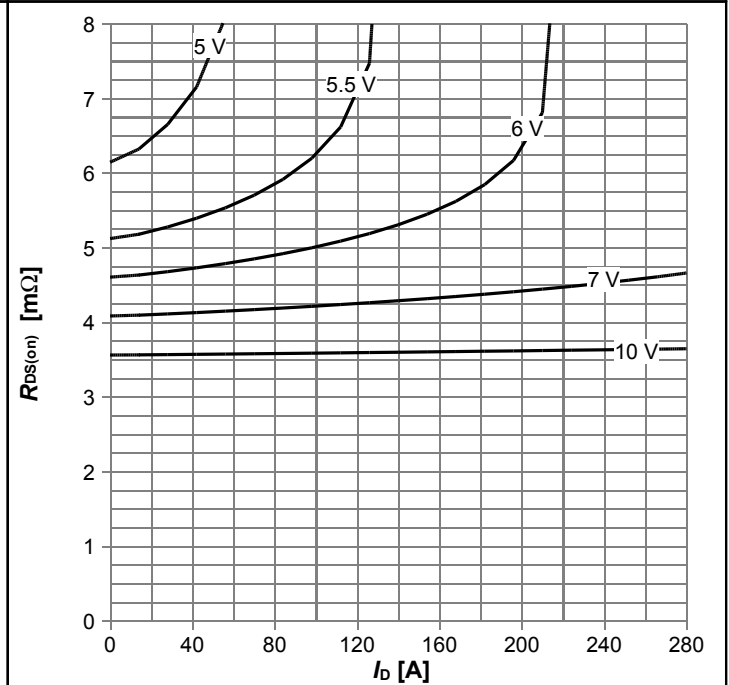

Diagram 5: Typ. output characteristics



$I_D=f(V_{DS}); T_j=25\text{ }^\circ\text{C};$ parameter: V_{GS}

Diagram 6: Typ. drain-source on resistance



$R_{DS(on)}=f(I_D); T_j=25\text{ }^\circ\text{C};$ parameter: V_{GS}

Diagram 7: Typ. transfer characteristics

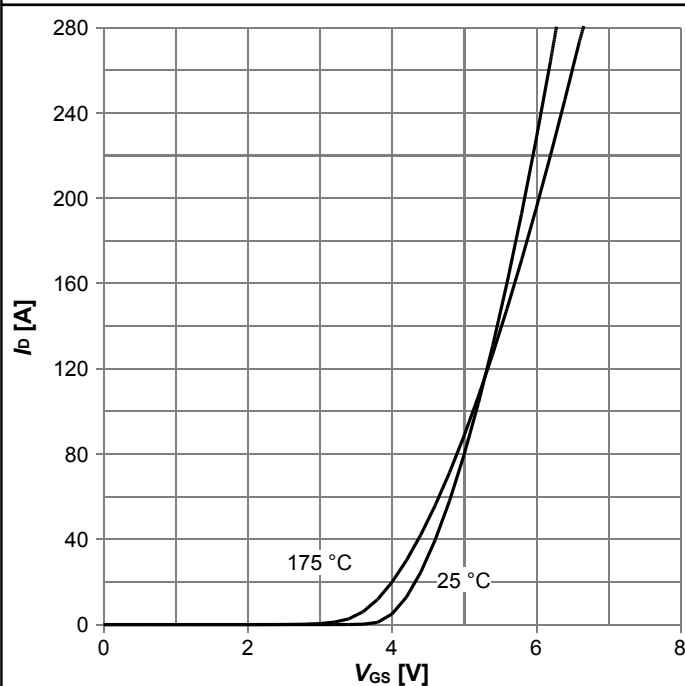

$I_D=f(V_{GS}); |V_{DS}|>2|I_D|R_{DS(on)max};$ parameter: T_j

Diagram 8: Typ. forward transconductance

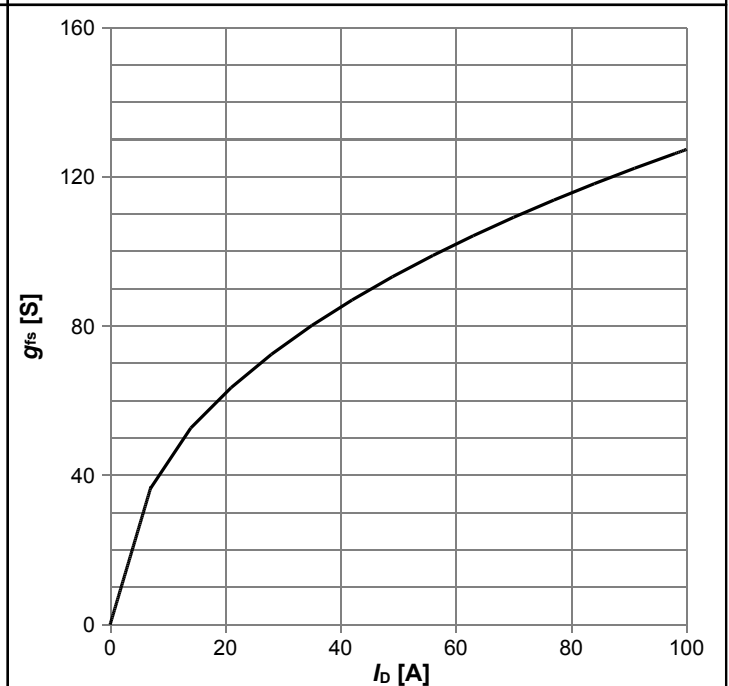

$g_{fs}=f(I_D); T_j=25\text{ }^\circ\text{C}$

Diagram 9: Drain-source on-state resistance

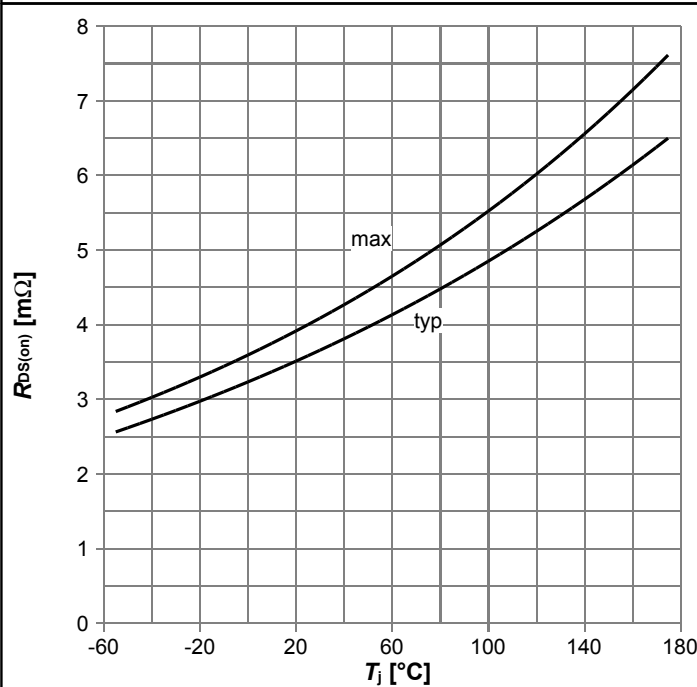

$R_{DS(on)}=f(T_j); I_D=69\text{ A}; V_{GS}=10\text{ V}$

Diagram 10: Typ. gate threshold voltage

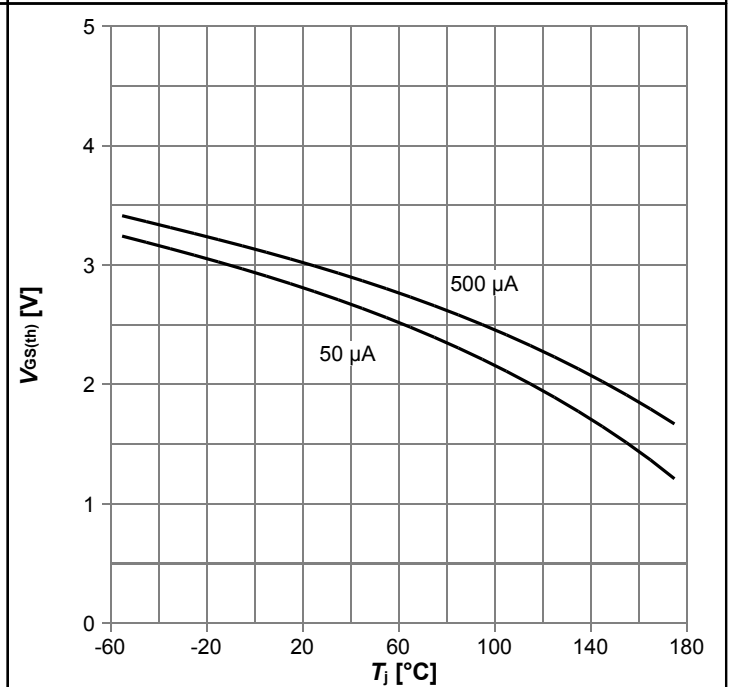

$V_{GS(th)}=f(T_j); V_{GS}=V_{DS}$

Diagram 11: Typ. capacitances

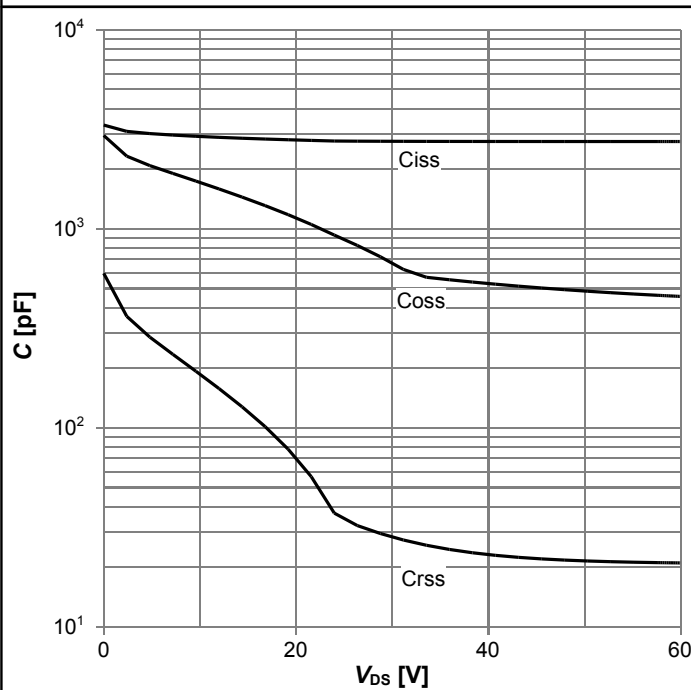

$C=f(V_{DS}); V_{GS}=0\text{ V}; f=1\text{ MHz}$

Diagram 12: Forward characteristics of reverse diode

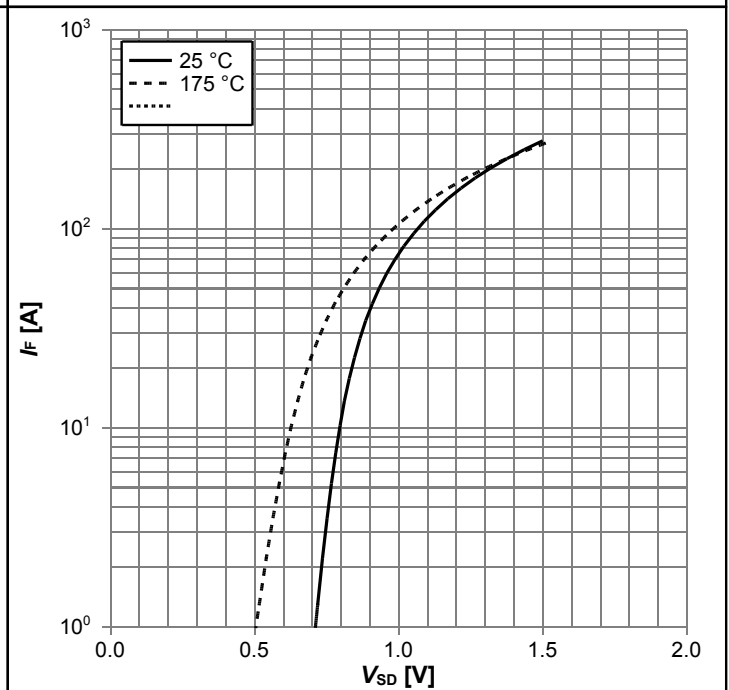

$I_F=f(V_{SD}); \text{parameter: } T_j$

Diagram 13: Avalanche characteristics

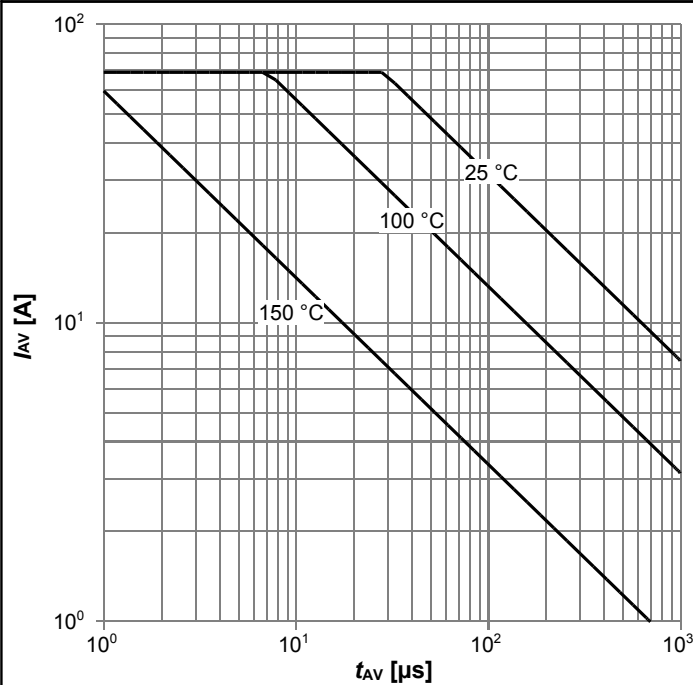

$I_{AS}=f(t_{AV})$; $R_{GS}=25 \Omega$; parameter: $T_{j(start)}$

Diagram 14: Typ. gate charge

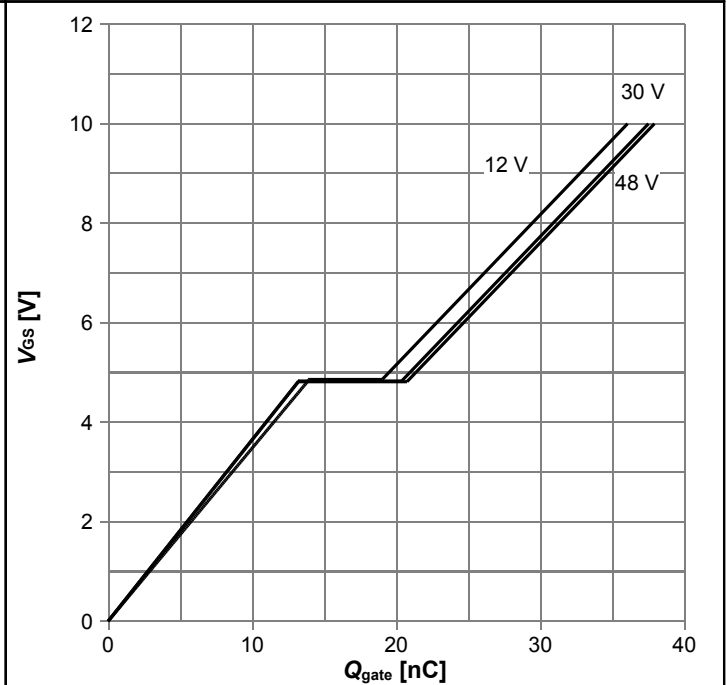

$V_{GS}=f(Q_{gate})$; $I_D=69$ A pulsed; parameter: V_{DD}

Diagram 15: Drain-source breakdown voltage

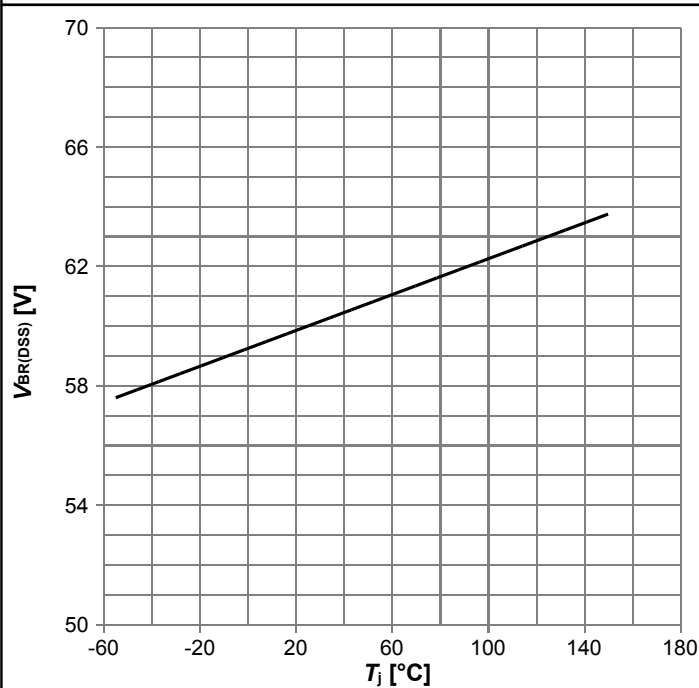

$V_{BR(DSS)}=f(T_j)$; $I_D=1$ mA

Gate charge waveforms

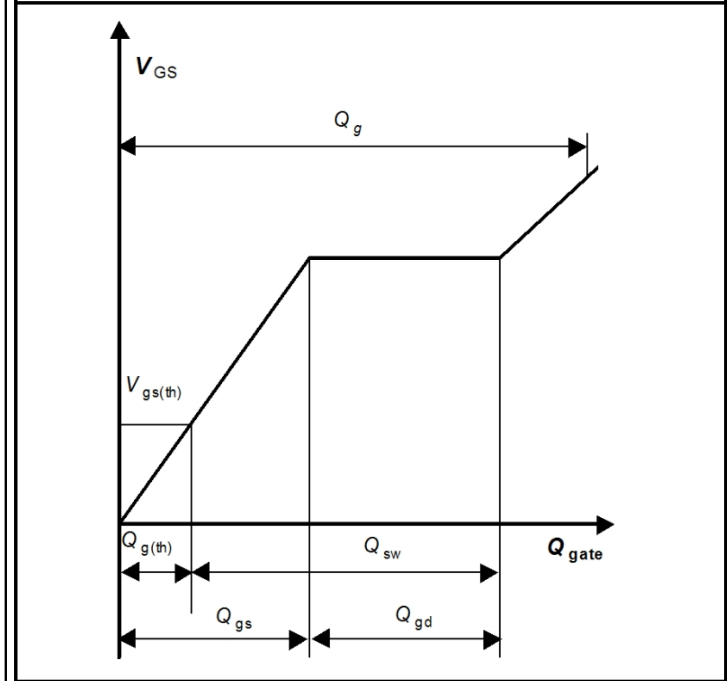

6 Package Outlines

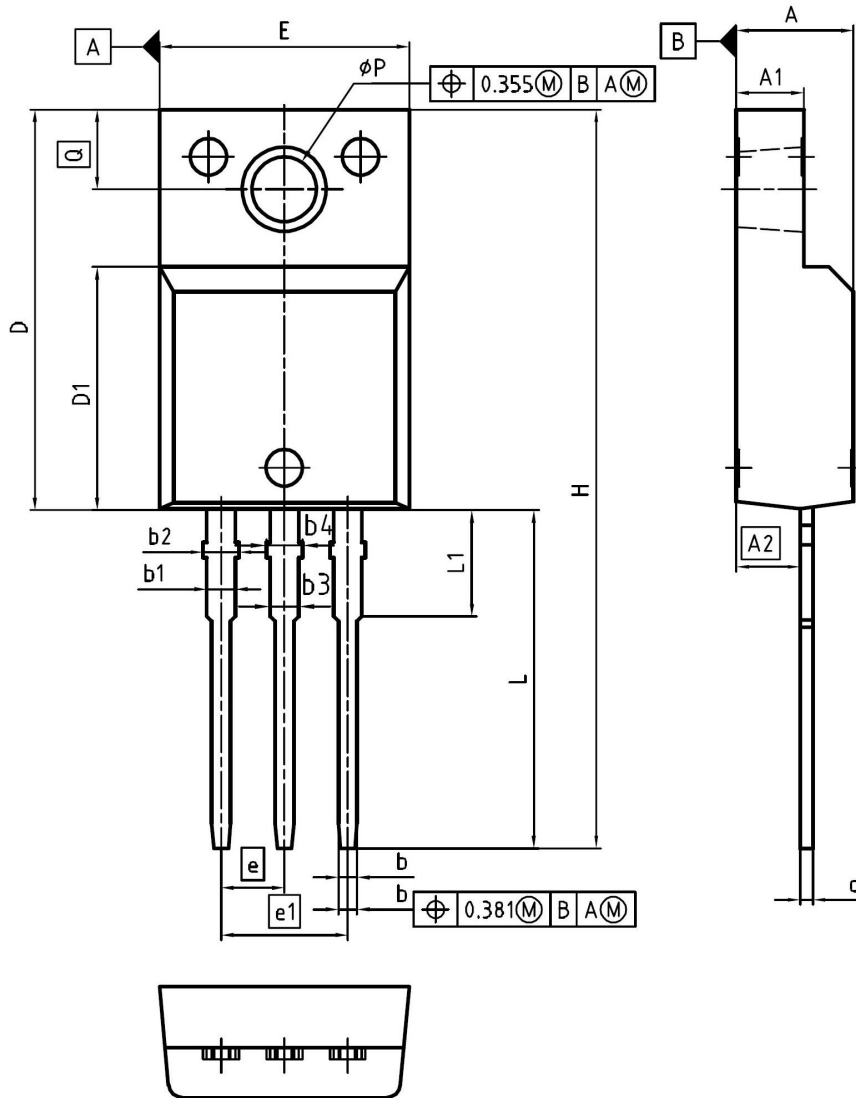

| DIM | MILLIMETERS | | INCHES | |
|-----|-------------|-------|--------|-------|
| | MIN | MAX | MIN | MAX |
| A | 4.55 | 4.85 | 0.179 | 0.191 |
| A1 | 2.55 | 2.85 | 0.100 | 0.112 |
| A2 | 2.42 | 2.72 | 0.095 | 0.107 |
| b | 0.65 | 0.85 | 0.026 | 0.033 |
| b1 | 0.95 | 1.33 | 0.037 | 0.052 |
| b2 | 0.95 | 1.51 | 0.037 | 0.059 |
| b3 | 0.65 | 1.33 | 0.026 | 0.052 |
| b4 | 0.65 | 1.51 | 0.026 | 0.059 |
| c | 0.40 | 0.63 | 0.016 | 0.025 |
| D | 15.85 | 16.15 | 0.624 | 0.636 |
| D1 | 9.53 | 9.83 | 0.375 | 0.387 |
| E | 10.35 | 10.65 | 0.407 | 0.419 |
| e | 2.54 | | 0.100 | |
| e1 | 5.08 | | 0.200 | |
| N | 3 | | 3 | |
| H | 29.45 | 29.75 | 1.159 | 1.171 |
| L | 13.45 | 13.75 | 0.530 | 0.541 |
| L1 | 3.15 | 3.45 | 0.124 | 0.136 |
| φP | 2.95 | 3.20 | 0.116 | 0.126 |
| Q | 3.15 | 3.50 | 0.124 | 0.138 |

DOCUMENT NO.
Z8B00003319

SCALE

EUROPEAN PROJECTION

ISSUE DATE
08-03-2007

REVISION
03

Figure 1 Outline PG-TO220-FP, dimensions in mm/inches

Revision History

IPA040N06N

Revision: 2014-06-19, Rev. 2.1

Previous Revision

| Revision | Date | Subjects (major changes since last revision) |
|----------|------------|--|
| 2.1 | 2014-06-19 | Rev.2.1 |

We Listen to Your Comments

Any information within this document that you feel is wrong, unclear or missing at all? Your feedback will help us to continuously improve the quality of this document. Please send your proposal (including a reference to this document) to:

erratum@infineon.com

Published by

Infineon Technologies AG

81726 München, Germany

© 2014 Infineon Technologies AG

All Rights Reserved.

Legal Disclaimer

The information given in this document shall in no event be regarded as a guarantee of conditions or characteristics. With respect to any examples or hints given herein, any typical values stated herein and/or any information regarding the application of the device, Infineon Technologies hereby disclaims any and all warranties and liabilities of any kind, including without limitation, warranties of non-infringement of intellectual property rights of any third party.

Information

For further information on technology, delivery terms and conditions and prices please contact your nearest Infineon Technologies Office (www.infineon.com).



Warnings

Due to technical requirements, components may contain dangerous substances. For information on the types in question, please contact the nearest Infineon Technologies Office.

The Infineon Technologies component described in this Data Sheet may be used in life-support devices or systems and/or automotive, aviation and aerospace applications or systems only with the express written approval of Infineon Technologies, if a failure of such components can reasonably be expected to cause the failure of that life-support, automotive, aviation and aerospace device or system or to affect the safety or effectiveness of that device or system. Life support devices or systems are intended to be implanted in the human body or to support and/or maintain and sustain and/or protect human life. If they fail, it is reasonable to assume that the health of the user or other persons may be endangered.

Looking for pricing, stock, or lifecycle information?

Click below to explore more details on WIN SOURCE:

-  [View IPA040N06NXKSA1 on WIN SOURCE](#)
-  [Infineon Technologies Information](#)

Optimize Your Supply Chain with WIN SOURCE Solutions

-  Global Sourcing Solution
-  Obsolete Management
-  Cost Control Management
-  Shortage Management
-  Alternative Solution
-  Excess Inventory Management