



**THE DATASHEET OF
PSMN1R2-25YL,115**





PSMN1R2-25YL

N-channel 25 V 1.2 mΩ logic level MOSFET in LPAK

Rev. 01 — 25 June 2009

Product data sheet

1. Product profile

1.1 General description

Logic level N-channel MOSFET in LPAK package qualified to 150 °C. This product is designed and qualified for use in a wide range of industrial, communications and domestic equipment.

1.2 Features and benefits

- Advanced TrenchMOS provides low $R_{DS(on)}$ and low gate charge
- High efficiency gains in switching power converters
- Improved mechanical and thermal characteristics
- LPAK provides maximum power density in a Power SO8 package

1.3 Applications

- DC-to-DC converters
- Lithium-ion battery protection
- Load switching
- Motor control
- Server power supplies

1.4 Quick reference data

Table 1. Quick reference

| Symbol | Parameter | Conditions | Min | Typ | Max | Unit |
|--------------------------------|--|---|-----|------|-----|------|
| V_{DS} | drain-source voltage | $T_j \geq 25\text{ °C}$; $T_j \leq 150\text{ °C}$ | - | - | 25 | V |
| I_D | drain current | $T_{mb} = 25\text{ °C}$; $V_{GS} = 10\text{ V}$; see Figure 1 | [1] | - | 100 | A |
| P_{tot} | total power dissipation | $T_{mb} = 25\text{ °C}$; see Figure 2 | - | - | 121 | W |
| T_j | junction temperature | | -55 | - | 150 | °C |
| Avalanche ruggedness | | | | | | |
| $E_{DS(AL)S}$ | non-repetitive drain-source avalanche energy | $V_{GS} = 10\text{ V}$; $T_{j(init)} = 25\text{ °C}$; $I_D = 100\text{ A}$; $V_{sup} \leq 25\text{ V}$; $R_{GS} = 50\text{ }\Omega$; unclamped | - | - | 677 | mJ |
| Dynamic characteristics | | | | | | |
| Q_{GD} | gate-drain charge | $V_{GS} = 4.5\text{ V}$; $I_D = 25\text{ A}$; | - | 11.9 | - | nC |
| $Q_{G(tot)}$ | total gate charge | $V_{DS} = 12\text{ V}$; see Figure 12 ; see Figure 13 | - | 50.6 | - | nC |

Table 1. Quick reference ...continued

| Symbol | Parameter | Conditions | Min | Typ | Max | Unit |
|-------------------------------|-------------------------------------|--|-----|-----|-----|------|
| Static characteristics | | | | | | |
| $R_{DS(on)}$ | drain-source on-state resistance | $V_{GS} = 10\text{ V}; I_D = 15\text{ A};$ $T_j = 100\text{ °C};$ see Figure 11 | - | - | 1.6 | mΩ |
| | | $V_{GS} = 10\text{ V}; I_D = 15\text{ A};$ $T_j = 25\text{ °C};$ see Figure 10 | - | 0.9 | 1.2 | mΩ |

[1] Continuous current is limited by package.

2. Pinning information

Table 2. Pinning information

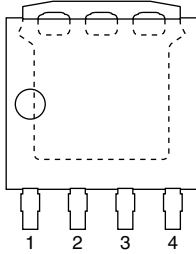
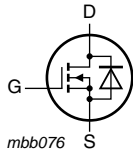
| Pin | Symbol | Description | Simplified outline | Graphic symbol |
|-----|--------|-------------|---|---|
| 1 | S | source |  |  |
| 2 | S | source | | |
| 3 | S | source | | |
| 4 | G | gate | | |
| mb | D | drain | | |

**SOT1023
(LFAK2)**

3. Ordering information

Table 3. Ordering information

| Type number | Package | | Version |
|--------------|---------|---|---------|
| | Name | Description | |
| PSMN1R2-25YL | LFAK2 | Plastic single-end surface-mounted package (LFAK2); 4 leads | SOT1023 |

4. Limiting values

Table 4. Limiting values

In accordance with the Absolute Maximum Rating System (IEC 60134).

| Symbol | Parameter | Conditions | Min | Max | Unit |
|-----------------------------|--|--|-----|-----|------|
| V _{DS} | drain-source voltage | T _j ≥ 25 °C; T _j ≤ 150 °C | - | 25 | V |
| V _{DGR} | drain-gate voltage | T _j ≥ 25 °C; T _j ≤ 150 °C; R _{GS} = 20 kΩ | - | 25 | V |
| V _{GS} | gate-source voltage | | -20 | 20 | V |
| I _D | drain current | V _{GS} = 10 V; T _{mb} = 100 °C; see Figure 1 | [1] | 100 | A |
| | | V _{GS} = 10 V; T _{mb} = 25 °C; see Figure 1 | [1] | 100 | A |
| I _{DM} | peak drain current | t _p ≤ 10 μs; pulsed; T _{mb} = 25 °C; see Figure 3 | - | 815 | A |
| P _{tot} | total power dissipation | T _{mb} = 25 °C; see Figure 2 | - | 121 | W |
| T _{stg} | storage temperature | | -55 | 150 | °C |
| T _j | junction temperature | | -55 | 150 | °C |
| T _{slid(M)} | peak soldering temperature | | - | 260 | °C |
| Source-drain diode | | | | | |
| I _S | source current | T _{mb} = 25 °C; | [1] | 100 | A |
| I _{SM} | peak source current | t _p ≤ 10 μs; pulsed; T _{mb} = 25 °C | - | 815 | A |
| Avalanche ruggedness | | | | | |
| E _{DS(AL)S} | non-repetitive drain-source avalanche energy | V _{GS} = 10 V; T _{j(init)} = 25 °C; I _D = 100 A; V _{sup} ≤ 25 V; R _{GS} = 50 Ω; unclamped | - | 677 | mJ |

[1] Continuous current is limited by package.

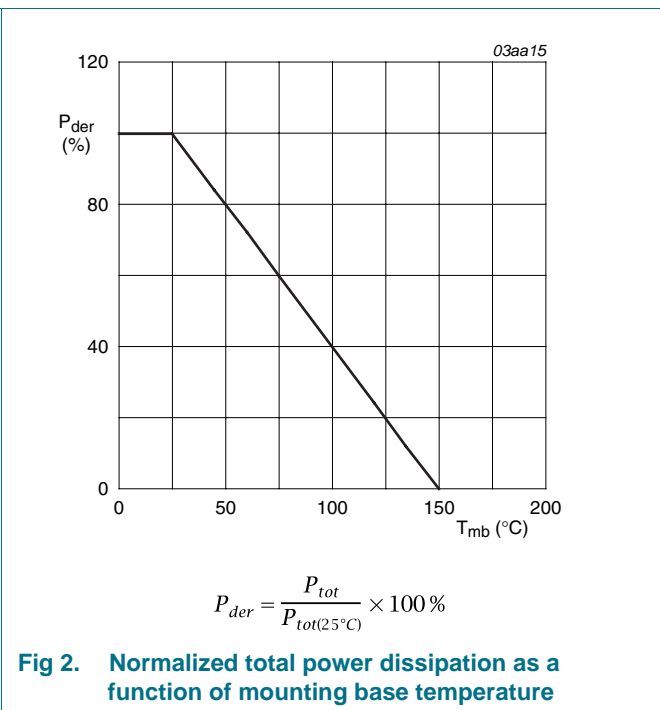
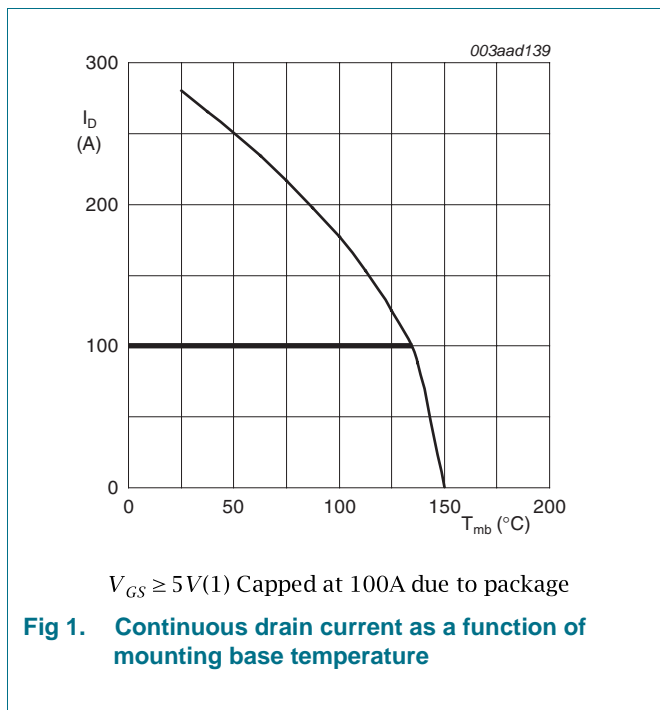

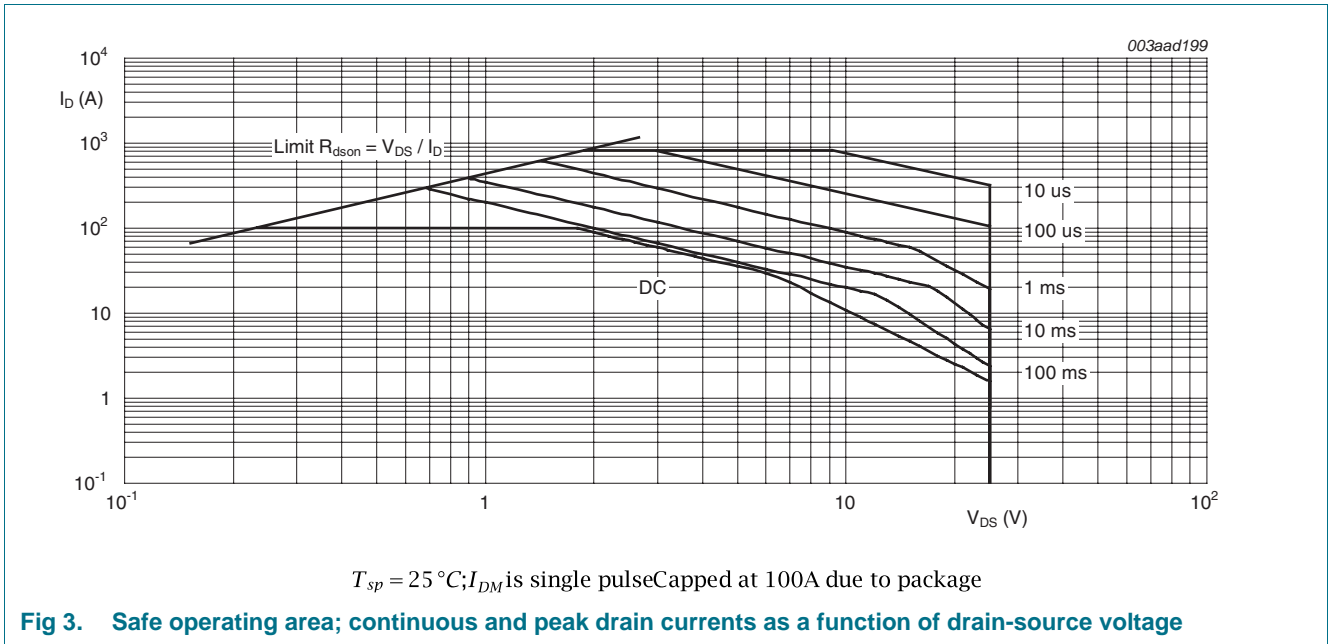

5. Thermal characteristics

Table 5. Thermal characteristics

| Symbol | Parameter | Conditions | Min | Typ | Max | Unit |
|----------------|---|------------------------------|-----|-----|-----|------|
| $R_{th(j-mb)}$ | thermal resistance from junction to mounting base | see Figure 4 | - | 0.4 | 1 | K/W |

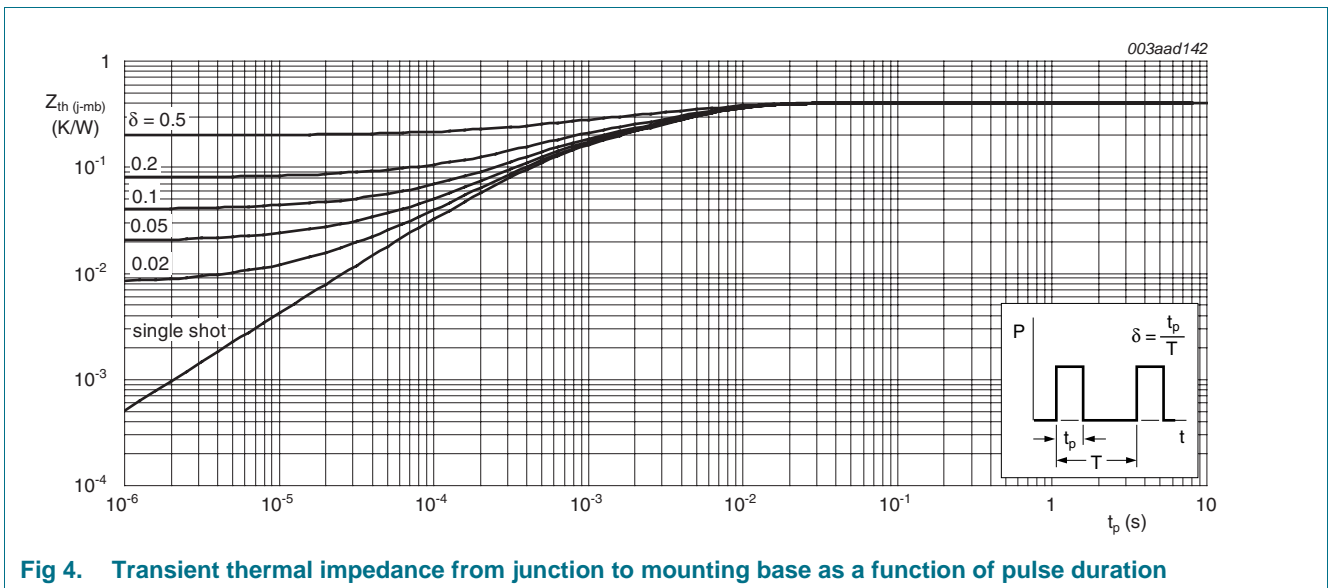

6. Characteristics

Table 6. Characteristics

| Symbol | Parameter | Conditions | Min | Typ | Max | Unit |
|--------------------------------|-----------------------------------|--|------|------|------|---------------|
| Static characteristics | | | | | | |
| $V_{(BR)DSS}$ | drain-source breakdown voltage | $I_D = 250 \mu\text{A}; V_{GS} = 0 \text{ V}; T_j = 25 \text{ }^\circ\text{C}$ | 25 | - | - | V |
| | | $I_D = 250 \mu\text{A}; V_{GS} = 0 \text{ V}; T_j = -55 \text{ }^\circ\text{C}$ | 22 | - | - | V |
| $V_{GS(th)}$ | gate-source threshold voltage | $I_D = 1 \text{ mA}; V_{DS} = V_{GS}; T_j = 25 \text{ }^\circ\text{C};$ see Figure 8 ; see Figure 9 | 1.3 | 1.7 | 2.15 | V |
| | | $I_D = 1 \text{ mA}; V_{DS} = V_{GS}; T_j = 150 \text{ }^\circ\text{C};$ see Figure 9 | 0.65 | - | - | V |
| | | $I_D = 1 \text{ mA}; V_{DS} = V_{GS}; T_j = -55 \text{ }^\circ\text{C};$ see Figure 9 | - | - | 2.45 | V |
| I_{DSS} | drain leakage current | $V_{DS} = 25 \text{ V}; V_{GS} = 0 \text{ V}; T_j = 25 \text{ }^\circ\text{C}$ | - | - | 1.5 | μA |
| | | $V_{DS} = 25 \text{ V}; V_{GS} = 0 \text{ V}; T_j = 150 \text{ }^\circ\text{C}$ | - | - | 500 | μA |
| I_{GSS} | gate leakage current | $V_{GS} = 16 \text{ V}; V_{DS} = 0 \text{ V}; T_j = 25 \text{ }^\circ\text{C}$ | - | - | 100 | nA |
| | | $V_{GS} = -16 \text{ V}; V_{DS} = 0 \text{ V}; T_j = 25 \text{ }^\circ\text{C}$ | - | - | 100 | nA |
| $R_{DS(on)}$ | drain-source on-state resistance | $V_{GS} = 4.5 \text{ V}; I_D = 15 \text{ A}; T_j = 25 \text{ }^\circ\text{C};$ see Figure 10 | - | 1.2 | 1.85 | mΩ |
| | | $V_{GS} = 10 \text{ V}; I_D = 15 \text{ A}; T_j = 100 \text{ }^\circ\text{C};$ see Figure 11 | - | - | 1.6 | mΩ |
| | | $V_{GS} = 10 \text{ V}; I_D = 15 \text{ A}; T_j = 150 \text{ }^\circ\text{C};$ see Figure 11 | - | - | 2.1 | mΩ |
| | | $V_{GS} = 10 \text{ V}; I_D = 15 \text{ A}; T_j = 25 \text{ }^\circ\text{C};$ see Figure 10 | - | 0.9 | 1.2 | mΩ |
| R_G | gate resistance | $f = 1 \text{ MHz}$ | - | 0.94 | - | Ω |
| Dynamic characteristics | | | | | | |
| $Q_{G(tot)}$ | total gate charge | $I_D = 25 \text{ A}; V_{DS} = 12 \text{ V}; V_{GS} = 10 \text{ V};$ see Figure 12 ; see Figure 13 | - | 105 | - | nC |
| | | $I_D = 25 \text{ A}; V_{DS} = 12 \text{ V}; V_{GS} = 4.5 \text{ V};$ see Figure 12 ; see Figure 13 | - | 50.6 | - | nC |
| Q_{GS} | gate-source charge | $I_D = 25 \text{ A}; V_{DS} = 12 \text{ V}; V_{GS} = 4.5 \text{ V};$ see Figure 12 ; see Figure 13 | - | 19.3 | - | nC |
| $Q_{GS(th)}$ | pre-threshold gate-source charge | | - | 8.1 | - | nC |
| $Q_{GS(th-pl)}$ | post-threshold gate-source charge | | - | 4.5 | - | nC |
| Q_{GD} | gate-drain charge | | - | 11.9 | - | nC |
| $V_{GS(pl)}$ | gate-source plateau voltage | $V_{DS} = 12 \text{ V};$ see Figure 12 | - | 2.6 | - | V |
| C_{iss} | input capacitance | $V_{DS} = 12 \text{ V}; V_{GS} = 0 \text{ V}; f = 1 \text{ MHz};$ $T_j = 25 \text{ }^\circ\text{C};$ see Figure 14 | - | 6380 | - | pF |
| C_{oss} | output capacitance | | - | 1640 | - | pF |
| C_{rss} | reverse transfer capacitance | | - | 644 | - | pF |

Table 6. Characteristics ...continued

| Symbol | Parameter | Conditions | Min | Typ | Max | Unit |
|---------------------------|-----------------------|--|-----|------|-----|------|
| $t_{d(on)}$ | turn-on delay time | $V_{DS} = 12\text{ V}; R_L = 0.5\ \Omega; V_{GS} = 4.5\text{ V};$ | - | 69 | - | ns |
| t_r | rise time | $R_{G(ext)} = 5.6\ \Omega$ | - | 125 | - | ns |
| $t_{d(off)}$ | turn-off delay time | | - | 94 | - | ns |
| t_f | fall time | | - | 56 | - | ns |
| Source-drain diode | | | | | | |
| V_{SD} | source-drain voltage | $I_S = 25\text{ A}; V_{GS} = 0\text{ V}; T_j = 25\text{ }^\circ\text{C};$ see Figure 15 | - | 0.78 | 1.2 | V |
| t_{rr} | reverse recovery time | $I_S = 20\text{ A}; di_S/dt = -100\text{ A}/\mu\text{s}; V_{GS} = 0\text{ V};$ | - | 52 | - | ns |
| Q_r | recovered charge | $V_{DS} = 20\text{ V}$ | - | 66 | - | nC |

[1] Tested to JEDEC standards where applicable.

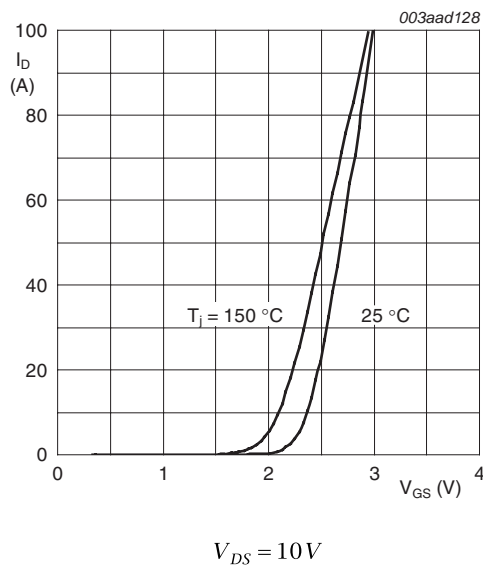

Fig 5. Transfer characteristics: drain current as a function of gate-source voltage; typical values

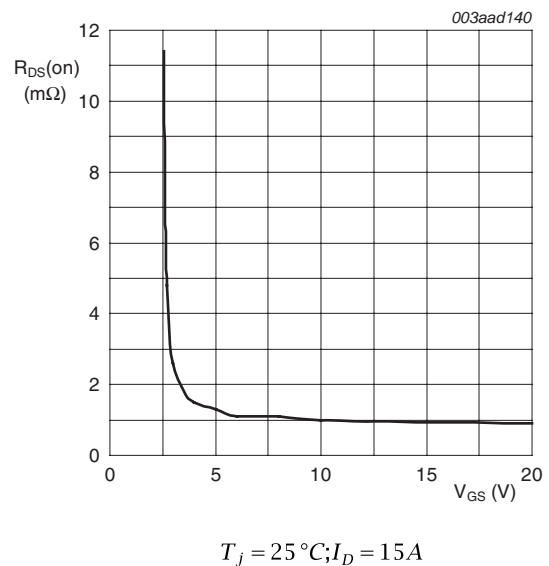
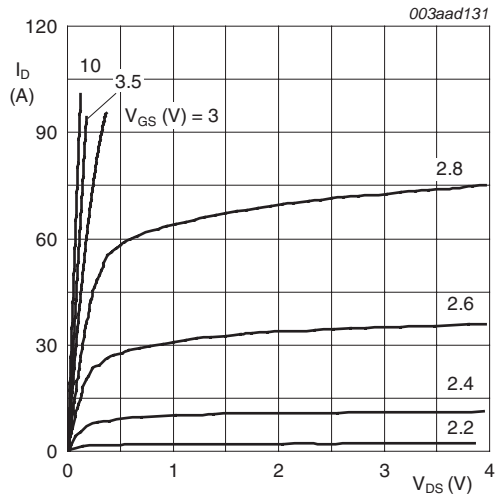
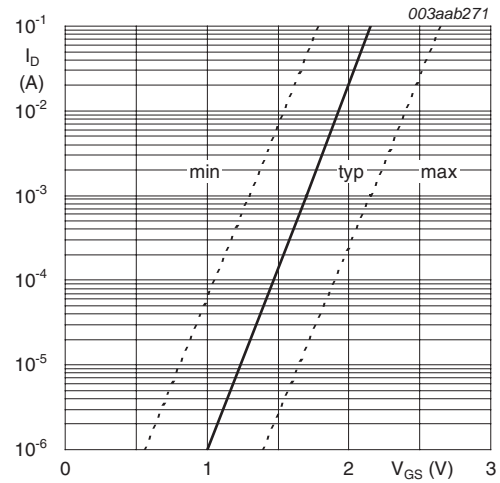

Fig 6. Drain-source on-state resistance as a function of gate-source voltage; typical values



$T_j = 25\text{ }^\circ\text{C}; t_p = 300\text{ }\mu\text{s}$

Fig 7. Output characteristics: drain current as a function of drain-source voltage; typical values



$T_j = 25\text{ }^\circ\text{C}; V_{DS} = 5\text{ V}$

Fig 8. Sub-threshold drain current as a function of gate-source voltage

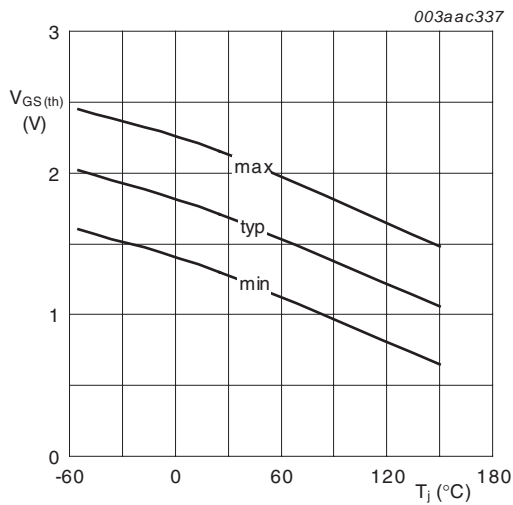

$I_D = 1\text{ mA}; V_{DS} = V_{GS}$

Fig 9. Gate-source threshold voltage as a function of junction temperature

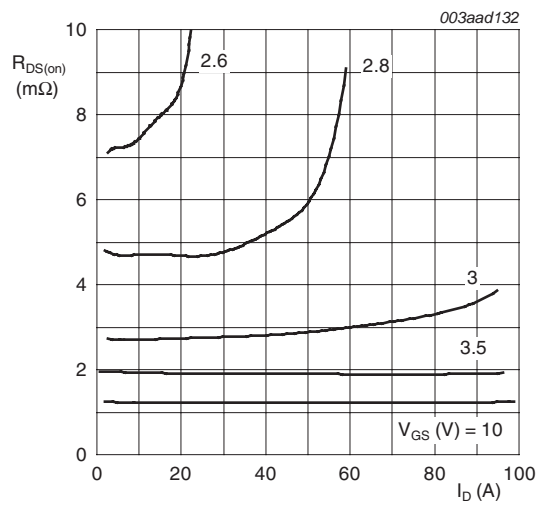

$T_j = 25\text{ }^\circ\text{C}; t_p = 300\text{ }\mu\text{s}$

Fig 10. Drain-source on-state resistance as a function of drain current; typical values

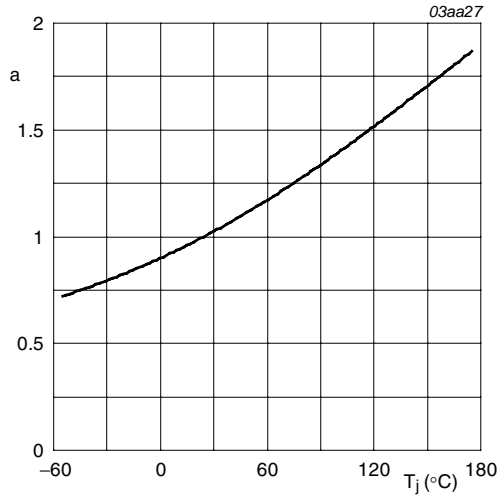

$$a = \frac{R_{DSon}}{R_{DSon(25^{\circ}C)}}$$

Fig 11. Normalized drain-source on-state resistance factor as a function of junction temperature

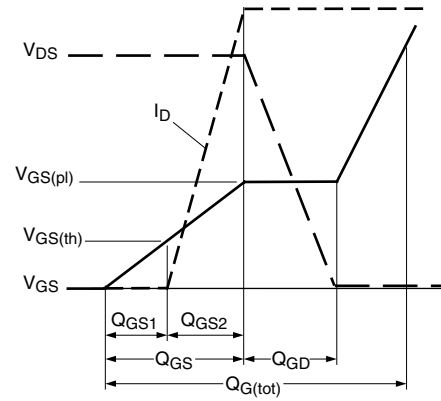
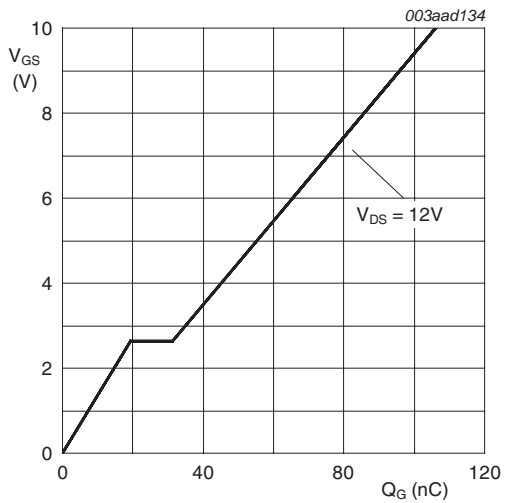
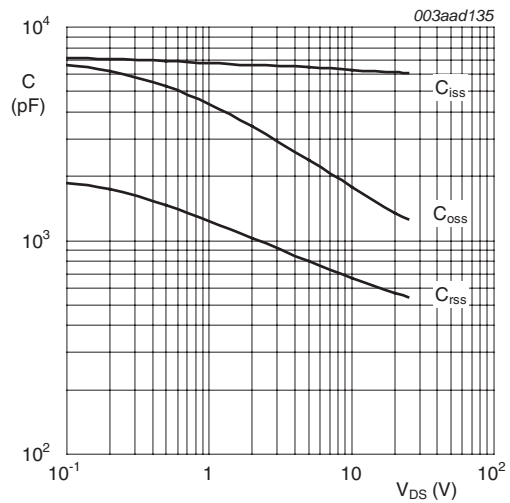

Fig 12. Gate charge waveform definitions



$T_j = 25^{\circ}C; I_D = 10A$

Fig 13. Gate-source voltage as a function of gate charge; typical values



$V_{GS} = 0V; f = 1MHz$

Fig 14. Input, output and reverse transfer capacitances as a function of drain-source voltage; typical values

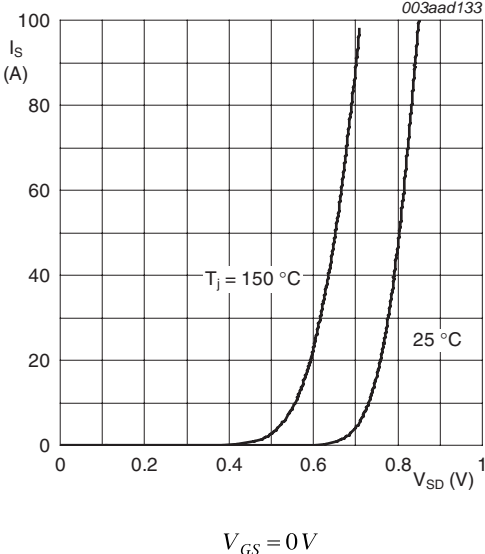
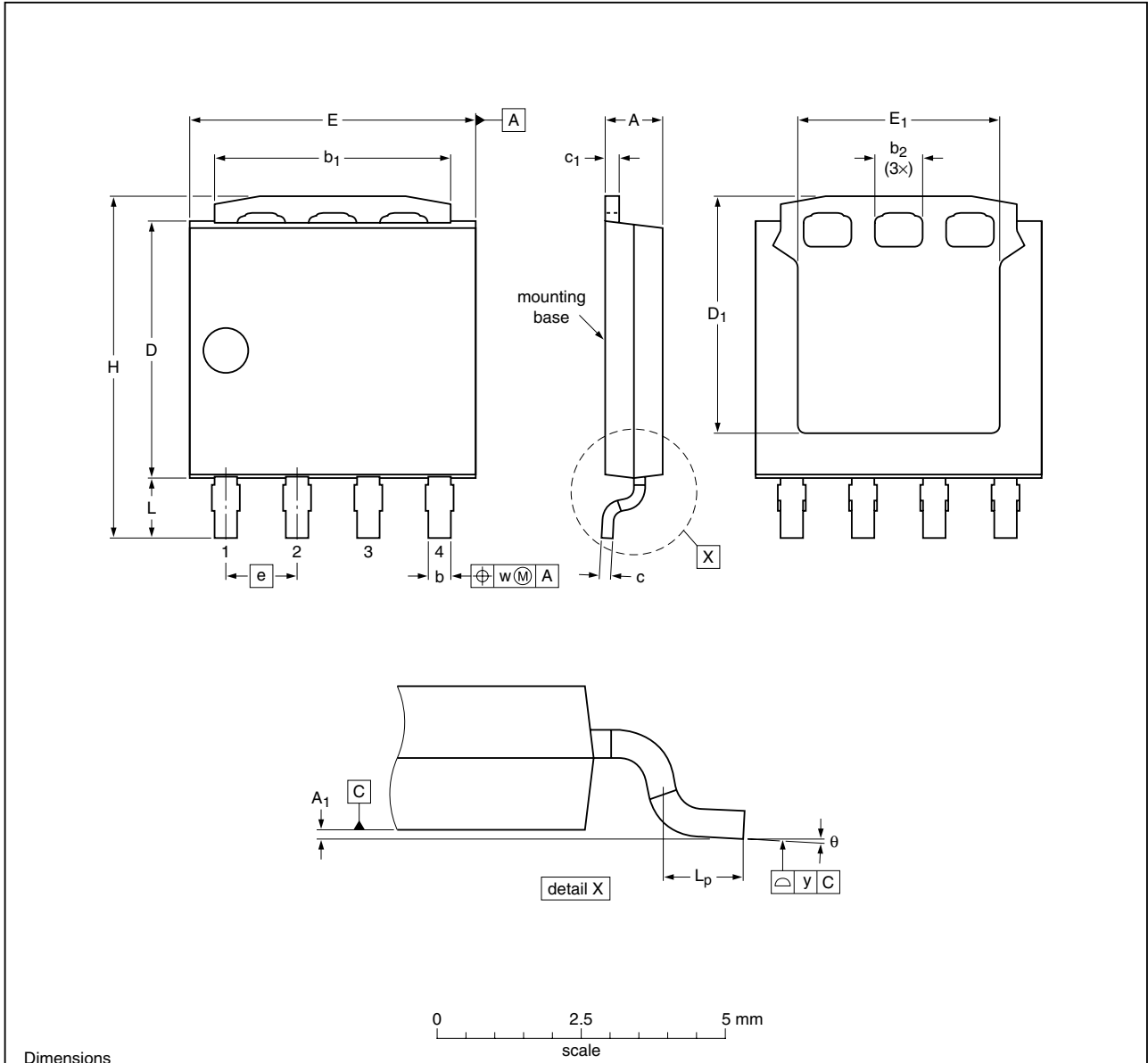

Fig 15. Source (diode forward) current as a function of source-drain (diode forward) voltage; typical values

7. Package outline

Plastic single-ended surface-mounted package (LPAK2); 4 leads

SOT1023



Dimensions

| Unit | A | A ₁ | b | b ₁ | b ₂ | c | c ₁ | D ⁽¹⁾ | D ₁ ⁽¹⁾ | E ⁽¹⁾ | E ₁ ⁽¹⁾ | e | H | L | L _p | w | y | θ |
|------|------|----------------|------|----------------|----------------|------|----------------|------------------|-------------------------------|------------------|-------------------------------|------|-----|-----|----------------|------|-----|----|
| max | 1.10 | 0.15 | 0.50 | 4.41 | | 0.25 | 0.30 | 4.70 | 4.45 | 5.30 | 3.7 | | 6.2 | 1.3 | 0.85 | | | 8° |
| nom | | | | 0.85 | | | | | | | | 1.27 | | | | 0.25 | 0.1 | |
| min | 0.95 | 0.00 | 0.35 | 3.62 | | 0.19 | 0.24 | 4.45 | | 4.95 | 3.5 | | 5.9 | 0.8 | 0.40 | | | 0° |

Note

1. Plastic or metal protrusions of 0.15 mm per side are not included.

sot1023_po

| Outline version | References | | | European projection | Issue date |
|-----------------|------------|-------|-------|---------------------|----------------------|
| | IEC | JEDEC | JEITA | | |
| SOT1023 | | | | | 08-10-13 09-05-26 |

Fig 16. Package outline SOT1023

8. Revision history

Table 7. Revision history

| Document ID | Release date | Data sheet status | Change notice | Supersedes |
|----------------|--------------|--------------------|---------------|------------|
| PSMN1R2-25YL_1 | 20090625 | Product data sheet | - | - |

9. Legal information

9.1 Data sheet status

| Document status ^{[1][2]} | Product status ^[3] | Definition |
|-----------------------------------|-------------------------------|---|
| Objective [short] data sheet | Development | This document contains data from the objective specification for product development. |
| Preliminary [short] data sheet | Qualification | This document contains data from the preliminary specification. |
| Product [short] data sheet | Production | This document contains the product specification. |

[1] Please consult the most recently issued document before initiating or completing a design.

[2] The term 'short data sheet' is explained in section "Definitions".

[3] The product status of device(s) described in this document may have changed since this document was published and may differ in case of multiple devices. The latest product status information is available on the Internet at URL <http://www.nexperia.com>.

9.2 Definitions

Draft — The document is a draft version only. The content is still under internal review and subject to formal approval, which may result in modifications or additions. Nexperia does not give any representations or warranties as to the accuracy or completeness of information included herein and shall have no liability for the consequences of use of such information.

Short data sheet — A short data sheet is an extract from a full data sheet with the same product type number(s) and title. A short data sheet is intended for quick reference only and should not be relied upon to contain detailed and full information. For detailed and full information see the relevant full data sheet, which is available on request via the local Nexperia sales office. In case of any inconsistency or conflict with the short data sheet, the full data sheet shall prevail.

9.3 Disclaimers

General — Information in this document is believed to be accurate and reliable. However, Nexperia does not give any representations or warranties, expressed or implied, as to the accuracy or completeness of such information and shall have no liability for the consequences of use of such information.

Right to make changes — Nexperia reserves the right to make changes to information published in this document, including without limitation specifications and product descriptions, at any time and without notice. This document supersedes and replaces all information supplied prior to the publication hereof.

Suitability for use — Nexperia products are not designed, authorized or warranted to be suitable for use in medical, military, aircraft, space or life support equipment, nor in applications where failure or malfunction of a Nexperia product can reasonably be expected to result in personal injury, death or severe property or environmental damage. Nexperia accepts no liability for inclusion and/or use of Nexperia products in such equipment or applications and therefore such inclusion and/or use is at the customer's own risk.

Applications — Applications that are described herein for any of these products are for illustrative purposes only. Nexperia makes no representation or warranty that such applications will be suitable for the specified use without further testing or modification.

Quick reference data — The Quick reference data is an extract of the product data given in the Limiting values and Characteristics sections of this document, and as such is not complete, exhaustive or legally binding.

Limiting values — Stress above one or more limiting values (as defined in the Absolute Maximum Ratings System of IEC 60134) may cause permanent damage to the device. Limiting values are stress ratings only and operation of the device at these or any other conditions above those given in the Characteristics sections of this document is not implied. Exposure to limiting values for extended periods may affect device reliability.

Terms and conditions of sale — Nexperia products are sold subject to the general terms and conditions of commercial sale, as published at <http://www.nexperia.com/profile/terms>, including those pertaining to warranty, intellectual property rights infringement and limitation of liability, unless explicitly otherwise agreed to in writing by Nexperia. In case of any inconsistency or conflict between information in this document and such terms and conditions, the latter will prevail.

No offer to sell or license — Nothing in this document may be interpreted or construed as an offer to sell products that is open for acceptance or the grant, conveyance or implication of any license under any copyrights, patents or other industrial or intellectual property rights.

Export control — This document as well as the item(s) described herein may be subject to export control regulations. Export might require a prior authorization from national authorities.

9.4 Trademarks

Notice: All referenced brands, product names, service names and trademarks are the property of their respective owners.

10. Contact information

For more information, please visit: <http://www.nexperia.com>



For sales office addresses, please send an email to: salesaddresses@nexperia.com

11. Contents

| | | |
|-----------|--|-----------|
| 1 | Product profile | 1 |
| 1.1 | General description | 1 |
| 1.2 | Features and benefits | 1 |
| 1.3 | Applications | 1 |
| 1.4 | Quick reference data | 1 |
| 2 | Pinning information | 2 |
| 3 | Ordering information | 2 |
| 4 | Limiting values | 3 |
| 5 | Thermal characteristics | 4 |
| 6 | Characteristics | 5 |
| 7 | Package outline | 10 |
| 8 | Revision history | 11 |
| 9 | Legal information | 12 |
| 9.1 | Data sheet status | 12 |
| 9.2 | Definitions | 12 |
| 9.3 | Disclaimers | 12 |
| 9.4 | Trademarks | 12 |
| 10 | Contact information | 12 |

Looking for pricing, stock, or lifecycle information?

Click below to explore more details on WIN SOURCE:

-  [View PSMN1R2-25YL,115 on WIN SOURCE](#)
-  [Nexperia USA Inc. Information](#)

Optimize Your Supply Chain with WIN SOURCE Solutions

-  Global Sourcing Solution
-  Obsolete Management
-  Cost Control Management
-  Shortage Management
-  Alternative Solution
-  Excess Inventory Management