



**THE DATASHEET OF
DEA075150HT-8036A1**





Nov. 2015 Ver.1.0
TDK Corporation

Multilayer High Pass Filter

For 5GHz W-LAN

DEA Series 0.65x0.5mm [EIA 0202] TYPE

P/N: **DEA075150HT-8036A1**

PRELIMINARYNov. 2015 Ver.1.0
TDK Corporation**DEA075150HT-8036A1****SHAPES AND DIMENSIONS**

[Top View]

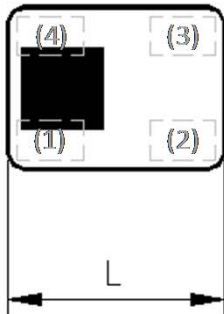

[Bottom View]

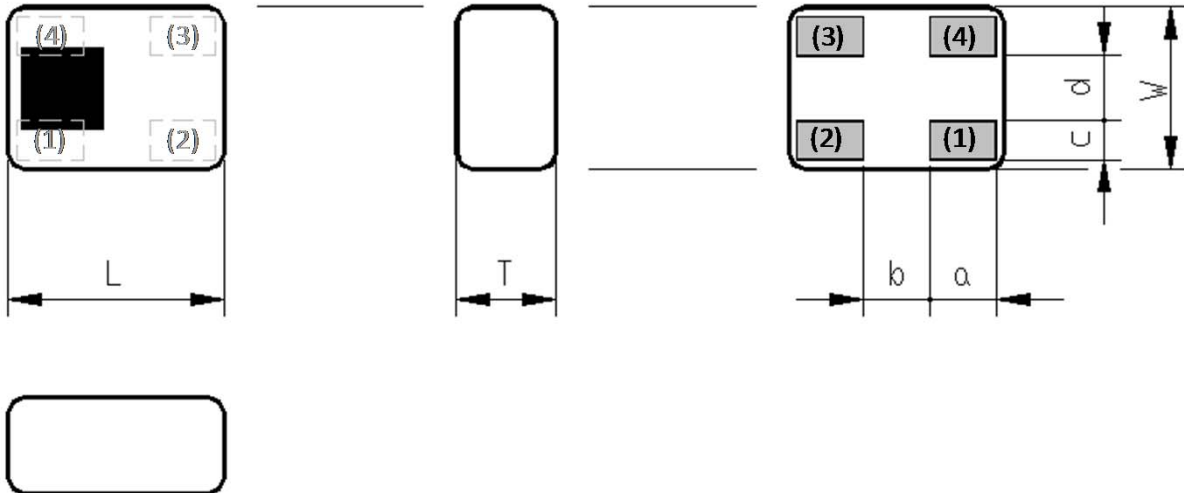

Dimensions (mm)

L	W	T	a	b	c	d
0.65	0.50	0.25	0.20	0.20	0.115	0.21
+/-0.05	+/-0.05	+/-0.05	+/-0.05	+/-0.05	+/-0.05	+/-0.05

Terminal functions

(1)	Input Port
(2)	Output Port
(3)	GND
(4)	GND

Note:

These samples are marked with trial sample identification.

In mass production, this sample marking will be changed to show in the TDK full specification.

TEMPERATURE RANGE

Operating temperature	Storage temperature
-40 to +85 °C	-40 to +85 °C

TERMINATION FINISH

Material
Au plate

All specifications are subject to change without notice.

TDK Technology - Proprietary and Confidential Information of TDK Group Companies

PRELIMINARYNov. 2015 Ver.1.0
TDK Corporation**DEA075150HT-8036A1****■ ELECTRICAL CHARACTERISTICS**

(Measurement)

Parameter	Frequency (MHz)	TDK Spec		
		Min.	Typ.	Max.
Insertion Loss (dB)	5150 to 5850	-	0.17	0.50
Attenuation (dB)	2400 to 2500	15	28	-
Characteristic Impedance (ohm)		50 (Nominal)		

Ta = +25+/-5°C

PRELIMINARY

Nov. 2015 Ver.1.0
TDK Corporation

DEA075150HT-8036A1

FREQUENCY CHARACTERISTICS

S11 POLA REF 1.0 U SCALE 1.0U FS

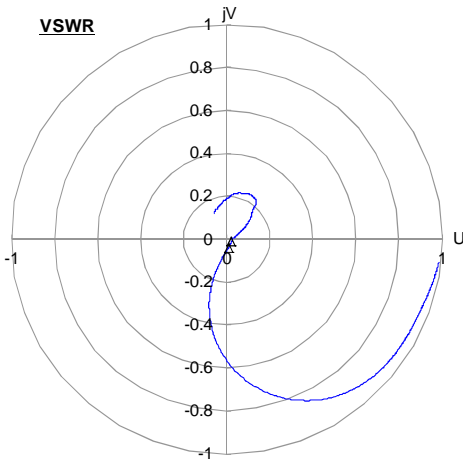

S21 Log MAG REF 0.0dB SCALE 1dB/

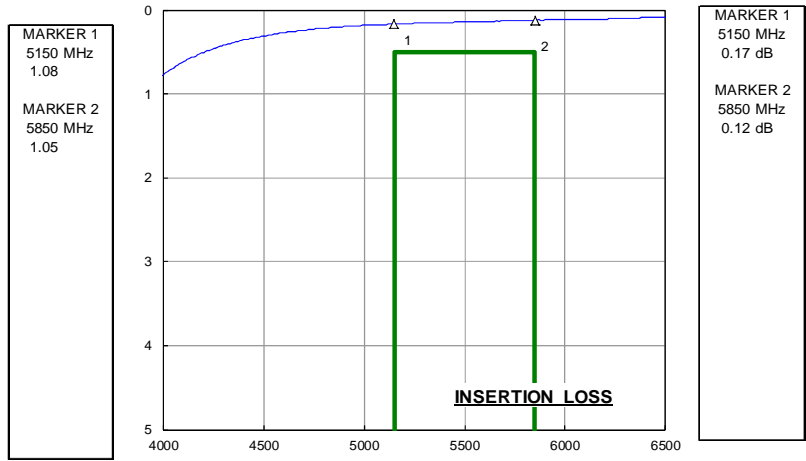

S21 Log MAG REF 0.0dB SCALE 5.0dB/

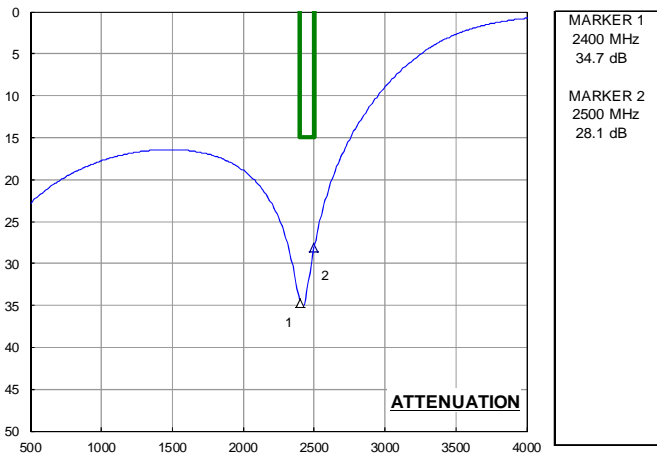

S11 Log MAG REF -10.0dB SCALE 5.0dB/

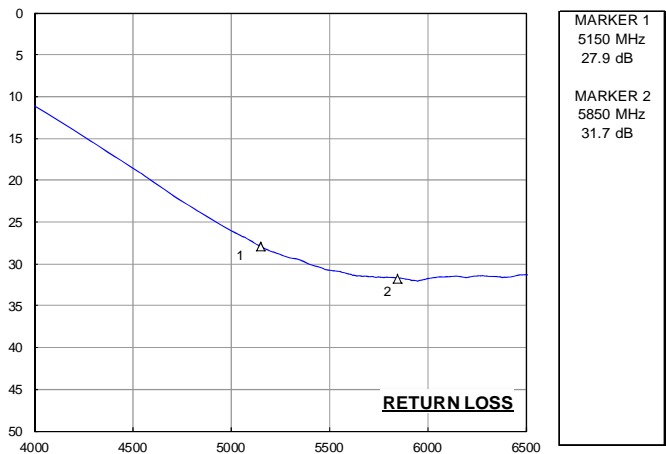

S21 Log MAG REF 0.0dB SCALE 5.0dB/

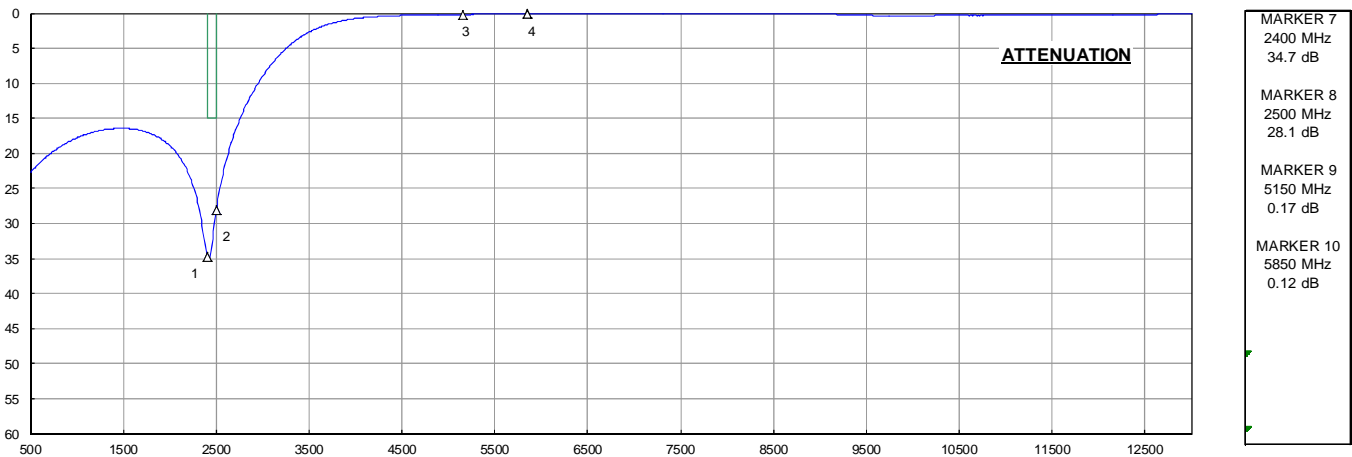

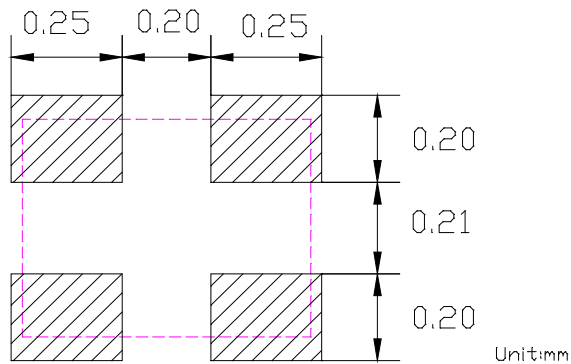
PRELIMINARYNov. 2015 Ver.1.0
TDK Corporation**DEA075150HT-8036A1****RECOMMENDED LAND PATTERN****ENVIROMENT INFORMATION**RoHS Statement
RoHS Compliance

PRELIMINARYNov. 2015 Ver.1.0
TDK Corporation**DEA075150HT-8036A1****RECOMMENDED REFLOW PROFILE**

Pb free solder

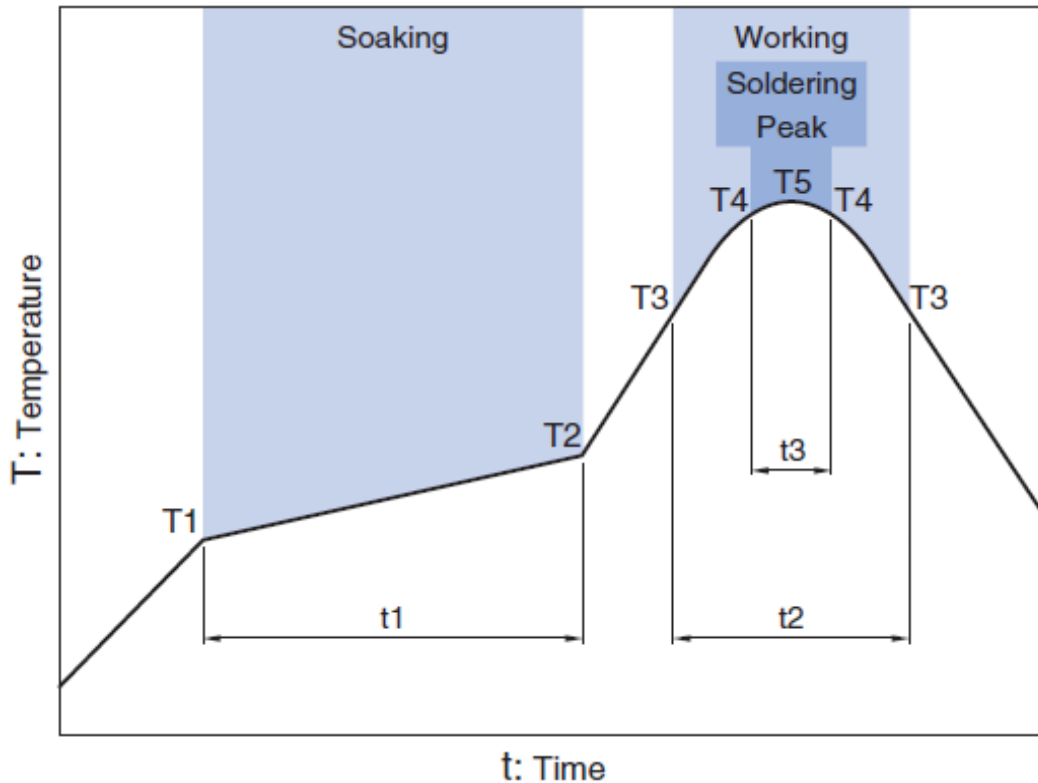

Soaking			Working		Soldering		Peak
Temp.	Temp.	Time	Temp.	Time	Temp.	Time	Temp.
T1	T2	t1	T3	t2	T4	t3	T5
150°C	180°C	60 to 120sec	230°C	more than 30sec	247 to 253°C	within 10sec	260°C Max.

All specifications are subject to change without notice.

TDK Technology - Proprietary and Confidential Information of TDK Group Companies

PRELIMINARY

Nov. 2015 Ver.1.0
TDK Corporation

DEA075150HT-8036A1

PACKAGING STYLE

Reel Dimensions

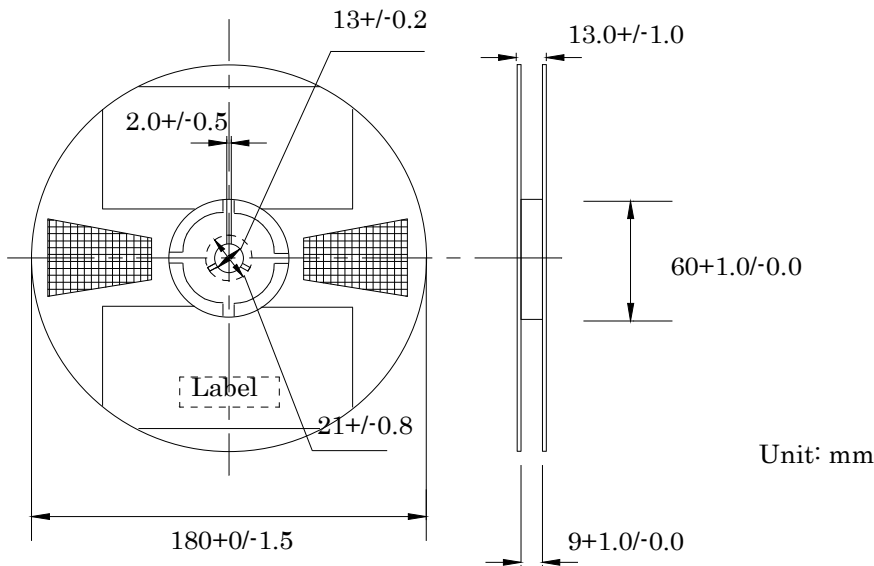

Carrier Tape

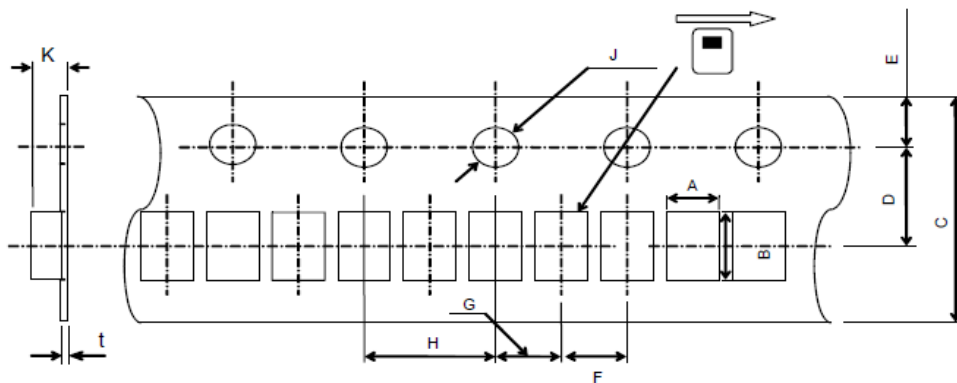

A	B	C	D	E	F
0.6±0.03	0.8±0.03	8.0±0.2	3.5±0.05	1.75±0.01	2.0±0.05
G	H	J	K	t	
2.0±0.05	4.0±0.1	1.5+0.1/-0	0.35±0.03	0.2±0.05	

STANDARD PACKAGE QUANTITY
(pieces/reel)
10,000

REMINDERS FOR USING THESE PRODUCTS

Before using these products, be sure to request the delivery specifications.

SAFETY REMINDERS

Please pay sufficient attention to the warnings for safe designing when using these products.

 REMINDERS
--

The products listed on this specification sheet are intended for use in general electronic equipment (AV equipment, telecommunications equipment, home appliances, amusement equipment, computer equipment, personal equipment, office equipment, measurement equipment, industrial robots) under a normal operation and use condition.



The products are not designed or warranted to meet the requirements of the applications listed below, whose performance and/or quality require a more stringent level of safety or reliability, or whose failure, malfunction or trouble could cause serious damage to society, person or property. Please understand that we are not responsible for any damage or liability caused by use of the products in any of the applications below or for any other use exceeding the range or conditions set forth in this specification sheet.

1. Aerospace/Aviation equipment
2. Transportation equipment (cars, electric trains, ships, etc.)
3. Medical equipment
4. Power-generation control equipment
5. Atomic energy-related equipment
6. Seabed equipment
7. Transportation control equipment
8. Public information-processing equipment
9. Military equipment
10. Electric heating apparatus, burning equipment
11. Disaster prevention/crime prevention equipment
12. Safety equipment
13. Other applications that are not considered general-purpose applications

When using this product in general-purpose applications, you are kindly requested to take into consideration securing protection circuit/equipment or providing backup circuits, etc., to ensure higher safety.

Looking for pricing, stock, or lifecycle information?

Click below to explore more details on WIN SOURCE:

-  [View DEA075150HT-8036A1 on WIN SOURCE](#)
-  [TDK Corporation Information](#)

Optimize Your Supply Chain with WIN SOURCE Solutions

-  Global Sourcing Solution
-  Obsolete Management
-  Cost Control Management
-  Shortage Management
-  Alternative Solution
-  Excess Inventory Management